

**JAERI-Data/Code**

**97-027**



**GROTRIAN DIAGRAMS FOR HIGHLY IONIZED COBALT  
Co VIII THROUGH Co XXVII**

**July 1997**

**Toshizo SHIRAI, Jack SUGAR\* and Wolfgang L. WIESE\***

**日本原子力研究所  
Japan Atomic Energy Research Institute**

本レポートは、日本原子力研究所が不定期に公開している研究報告書です。  
入手の間合わせは、日本原子力研究所研究情報部研究情報課（〒319-11 茨城県那珂郡東海村）あて、お申し越してください。なお、このほかに財団法人原子力弘済会資料センター（〒319-11 茨城県那珂郡東海村日本原子力研究所内）で複写による実費頒布をおこなっております。

This report is issued irregularly.

Inquiries about availability of the reports should be addressed to Research Information Division, Department of Intellectual Resources, Japan Atomic Energy Research Institute, Tokai-mura, Naka-gun, Ibaraki-ken 319-11, Japan.

© Japan Atomic Energy Research Institute, 1997

編集兼発行 日本原子力研究所  
印 刷 (株)原子力資料サービス

Grotrian Diagrams for Highly Ionized Cobalt  
Co VIII through Co XXVII

Toshizo SHIRAI, Jack SUGAR\* and Wolfgang L. WIESE\*

Department of Reactor Engineering  
Tokai Research Establishment  
Japan Atomic Energy Research Institute  
Tokai-mura, Naka-gun, Ibaraki-ken

(Received June 17, 1997)

Grotrian diagrams are presented to provide graphical overviews for 1,247 spectral lines of highly ionized cobalt, Co VIII through Co XXVII. In the usual diagram display such as that by Bashkin and Stoner [North-Holland, Amsterdam, 1975], the density of transitions is often too high to allow each transition to be drawn separately. Here in our modified diagrams, the transitions are also represented by lines connecting the upper and lower energy levels, but the lower energy levels are extended and repeated for successive configurations as needed. As a sequence, dense packing is avoided and all lines in a multiplet can be accommodated.

Keywords: Energy Levels, Wavelengths, Cobalt Ions, Grotrian Diagrams

---

\* National Institute of Standards and Technology

高電離コバルト, Co VIII-Co XXVII のグロトリアン図

日本原子力研究所東海研究所原子炉工学部  
白井 稔三・Jack SUGAR\*・Wolfgang L. WIESE\*

(1997年6月17日受理)

高電離コバルト, Co VIII-Co XXVII の1,247本のスペクトル線をエネルギー準位と遷移の特徴を視覚化するグロトリアン図にまとめた。Bashkin and Stoner [North-Holland, Amsterdam, 1975] による通常のグロトリアン図の表示法では, それぞれの遷移を表す線の密度が高くなり過ぎ, 全ての遷移を表示できないことがしばしばある。我々のグロトリアン図でも遷移を線で表すが, しかし, 遷移の下位準位を必要なだけ繰り返す方法に変更した。その結果, 遷移線の高密度化が回避でき, 多重項等全ての遷移を表すことができた。

## Contents

1. Introduction .....	1
Acknowledgments .....	1
References .....	2
2. Grotrian Diagrams.....	3
2.1 Explanation of Grotrian Diagrams.....	3

## 目    次

1. 緒    言 .....	1
謝    辞.....	1
参考文献.....	2
2. グロトリアン図 .....	3
2.1 グロトリアン図の説明 .....	3

## 1. Introduction

During the last 10 years we have published a series of spectroscopic data table for highly ionized heavy atoms that occur either as impurities in fusion energy devices or which have been injected into these hot plasmas for diagnostic purposes. These spectroscopic data are required both for modelling the energy balance and impurity cooling effects in such plasmas as well as for applying non-perturbing spectroscopic techniques to determine plasma parameters. In addition, spectroscopic data needs for highly ionized atoms exist in astrophysics, especially the physics of the solar corona, and in atomic physics research. A good bit of new spectral analysis work, both observations and calculations, had been done in recent years, and the results had not been tabulated conveniently before. We have thus critically compiled these spectroscopic data into single monographs for each element and have published, in order of nuclear charge, such tables for the spectra of Ti, V, Cr, Mn, Fe, Co, Ni, Cu, Kr, and Mo ions.

Since we have now compiled this series, we are presenting all these data in a single volume [1] to provide users with the convenience of a single source. However, we do not include the extensive Grotrian diagrams to provide graphical overviews because these would make this volume very large and unwidely.

This report contains all Grotrian diagrams for Co VIII through Co XXVII. The Grotrian diagrams show energy levels and the principal transitions. Typical examples of such diagrams are found in the book published by Bashkin and Stoner [2]. In the usual diagram display such as that by Bashkin and Stoner, the density of transitions is often too high to allow each transition to be drawn separately. Here in our modified diagrams, the transitions are also represented by lines connecting the upper and lower energy levels, but the lower energy levels are extended and repeated for successive configurations as needed. As a sequence, dense packing is avoided and all lines in a multiplet can be accommodated. The diagrams thus allow a quick survey of the principal features of the levels and transitions in the various ions.

## Acknowledgments

The present research was organized and inspired by Dr. M. Nakagawa, Chairman of the Research Committee on Atomic and Molecular Data of the Japan Atomic Energy Research Institute, to whom the authors owe special thanks. This work was undertaken under the U.S.-Japan Fusion Cooperation Program and partially supported by the Office of Fusion Energy of the U.S. Department of Energy.

## References

- [1] T. Shirai, J. Sugar and W. L. Wiese, *J. Phys. Chem. Ref. Data*, Monograph 8 (1997).
- [2] S. Bashkin and J. O. Stoner, Jr., *Atomic Energy Levels and Grotrian Diagrams*, Vol. II, *Sulfur I - Titanium XXII* (North-Holland, Amsterdam, 1975).

## 2. Grotrian Diagrams

### 2.1 Explanation of Grotrian Diagrams

Co XIII, Co XXVII, etc.

According to spectroscopic convention, Co I indicates the first spectrum, i.e., the spectrum of neutral atom; Co II denotes the second spectrum, belonging to the singly ionized atom; and so on.

H-Sequence, C-Sequence, etc.

Indicates that the respective Co ion has the same number of electrons as neutral hydrogen, neutral carbon, etc.

Abscissa

Energy in the levels in  $\text{cm}^{-1}$ .

Short vertical lines

Energy levels are indicated as the vertical lines. The electronic configuration (with the parentage in parentheses) and the level energy in  $\text{cm}^{-1}$  are given to the right of the vertical line, and at the top is the J value. A symbol "?" after the level value indicates level was derived from a tentatively classified line. Theoretical levels are given in square brackets. Energy levels with the same LS label for the upper term are grouped together. The term designation is given at the right of the diagram; the ordering is by increasing multiplicity and orbital angular momentum. For the lower level, the term is adjacent to the configuration.

Horizontal lines

Transitions between levels. The number below each line gives the transition wavelength in Angstrom ( $10^{-8}\text{cm}$ ). Heavier dashed lines indicate resonance transitions with  $gf \geq 0.01$ , where  $gf$  denotes the product of the statistical weight ( $g$ ) of lower level and the absorption oscillator strength ( $f$ ).

C,T,P,S

Superscripts to the right of a wavelength value have the following meanings:

<sup>C</sup> wavelength calculated from energy level data using the Ritz combination principle.

<sup>T</sup> wavelength tentatively identified.

<sup>P</sup> wavelength predicted along a isoelectronic sequence.

<sup>S</sup> wavelength smoothed along a isoelectronic sequence.

Limit

Principal ionization limit in  $\text{cm}^{-1}$  and eV.



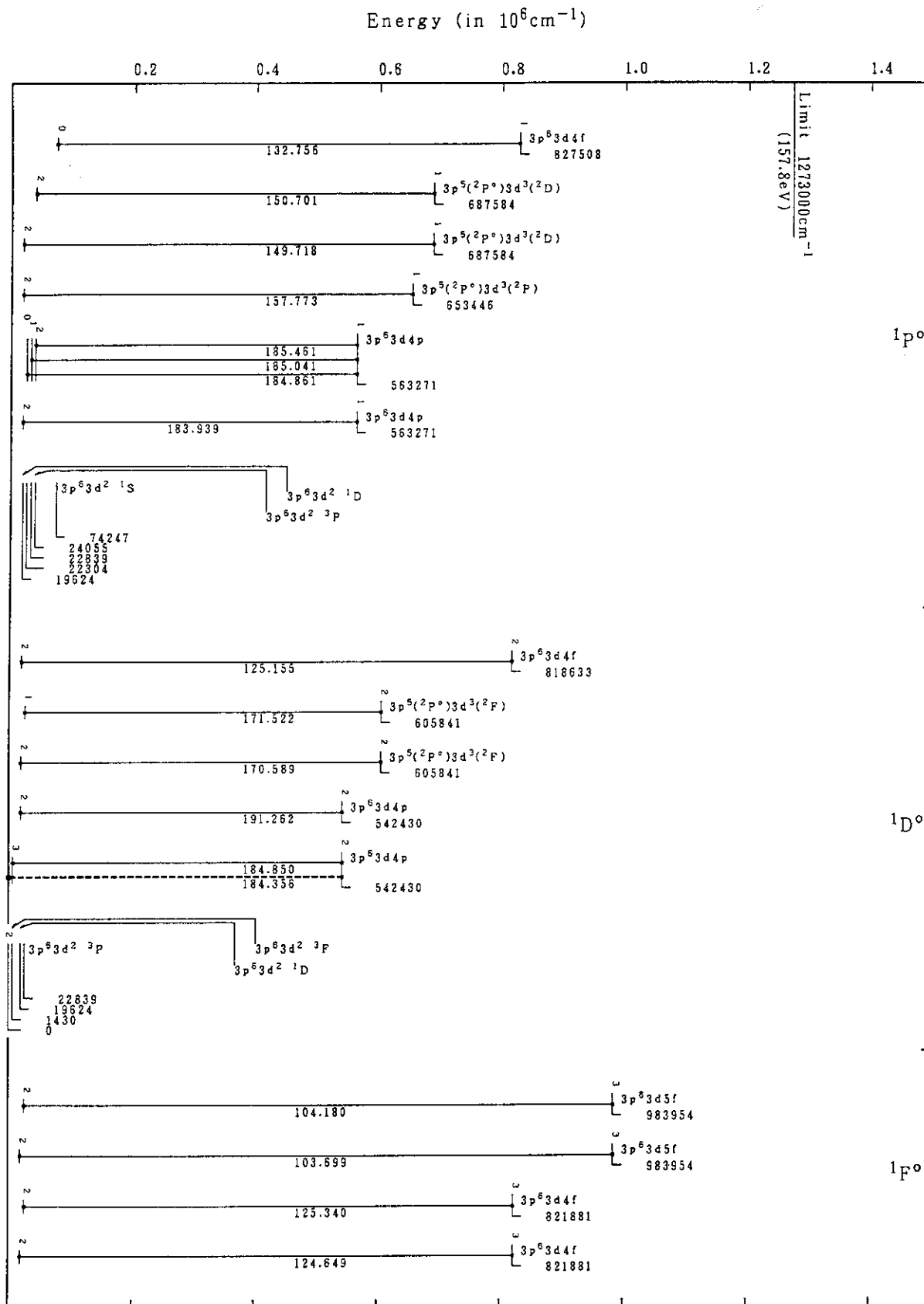

Co VIII (Ca-Sequence)

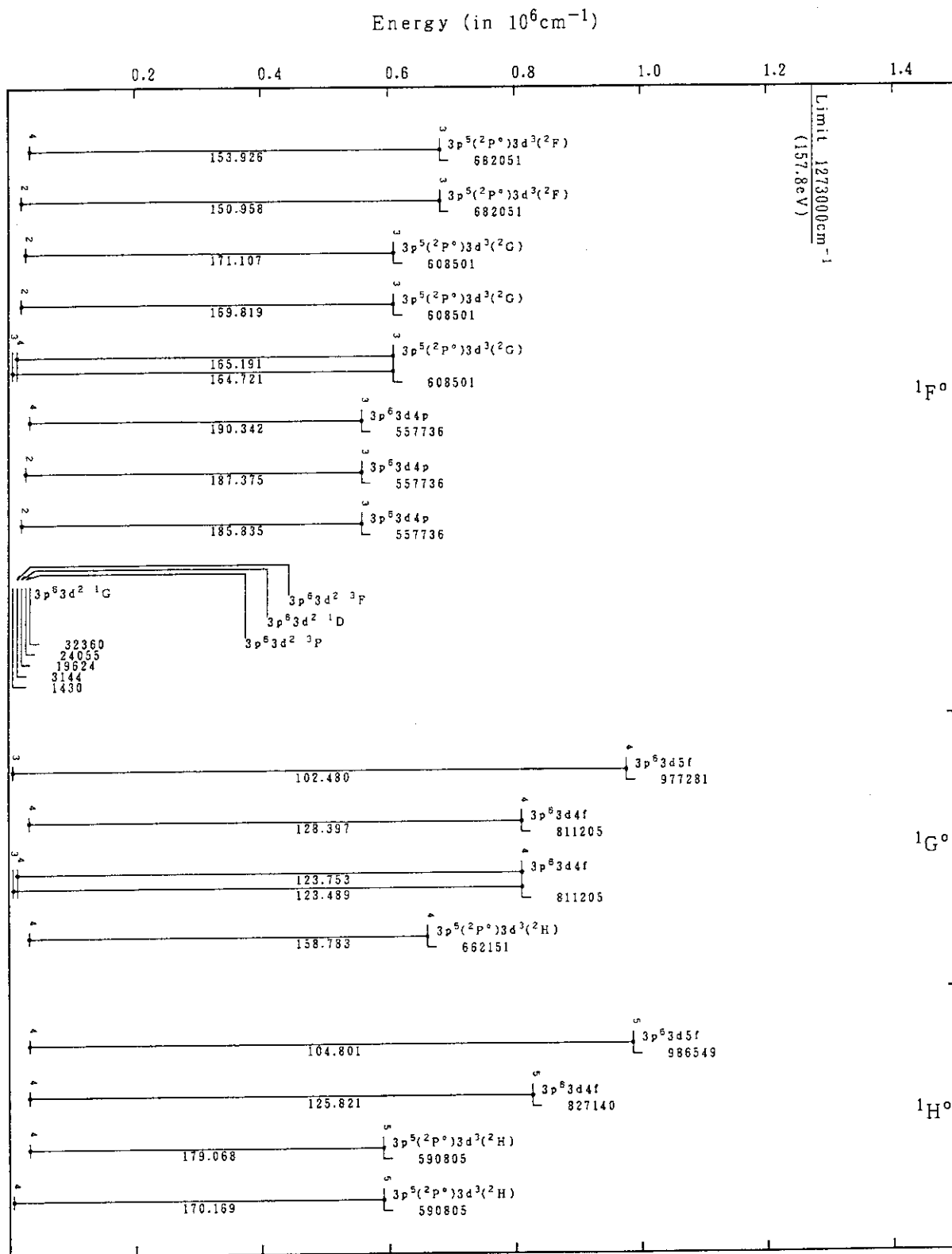

Co VIII (Ca-Sequence)

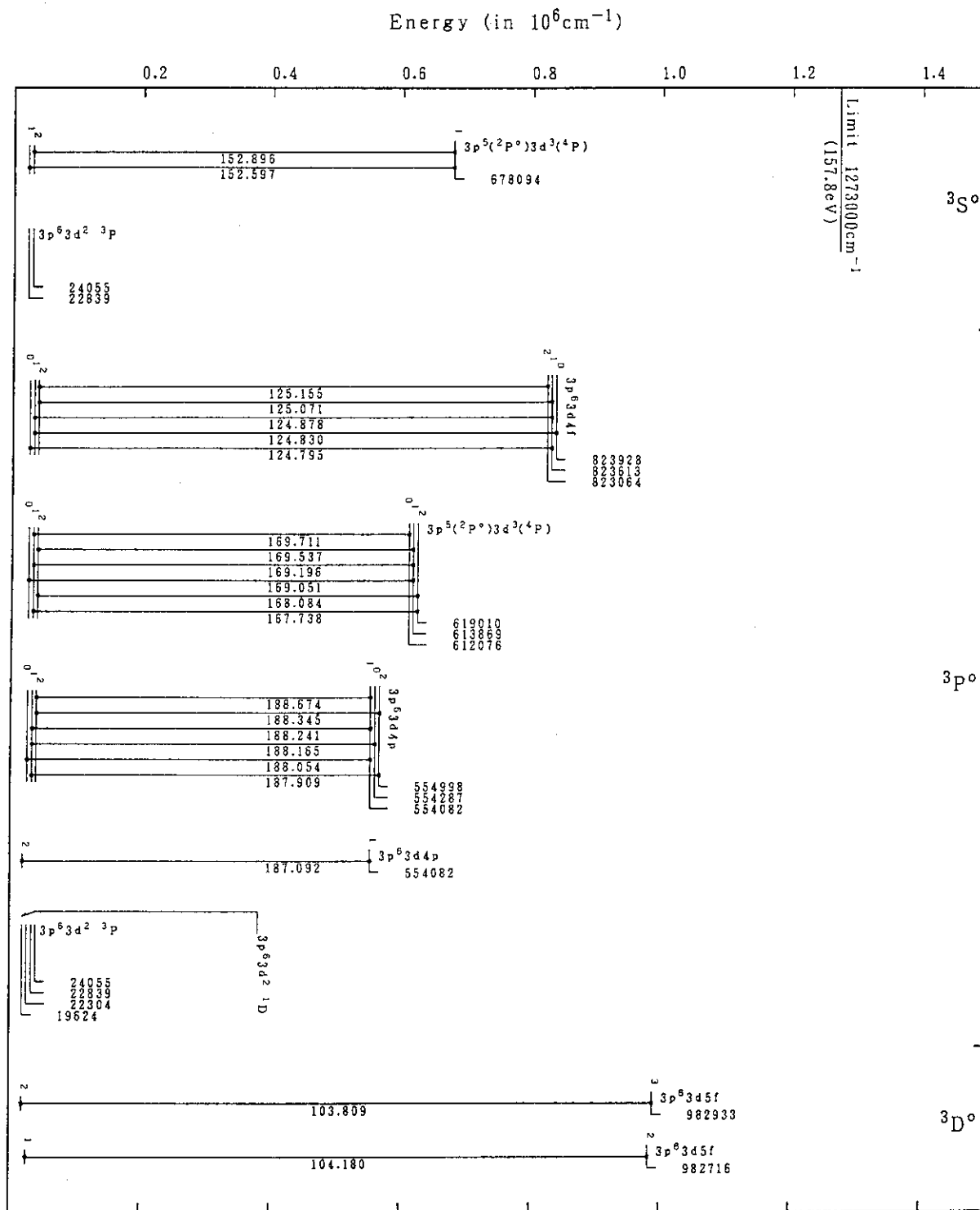

Co VIII (Ca-Sequence)

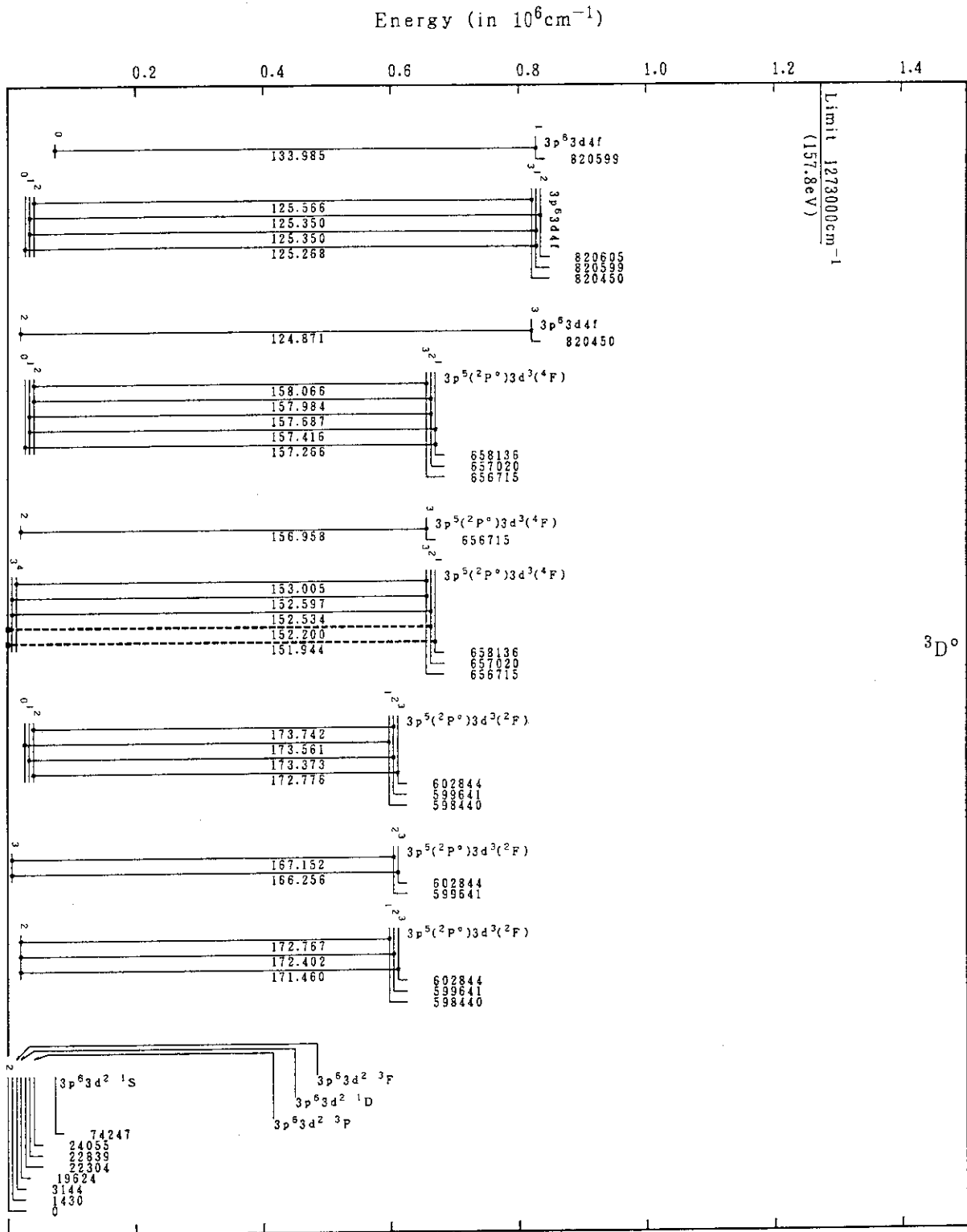

Co VIII (Ca-Sequence)

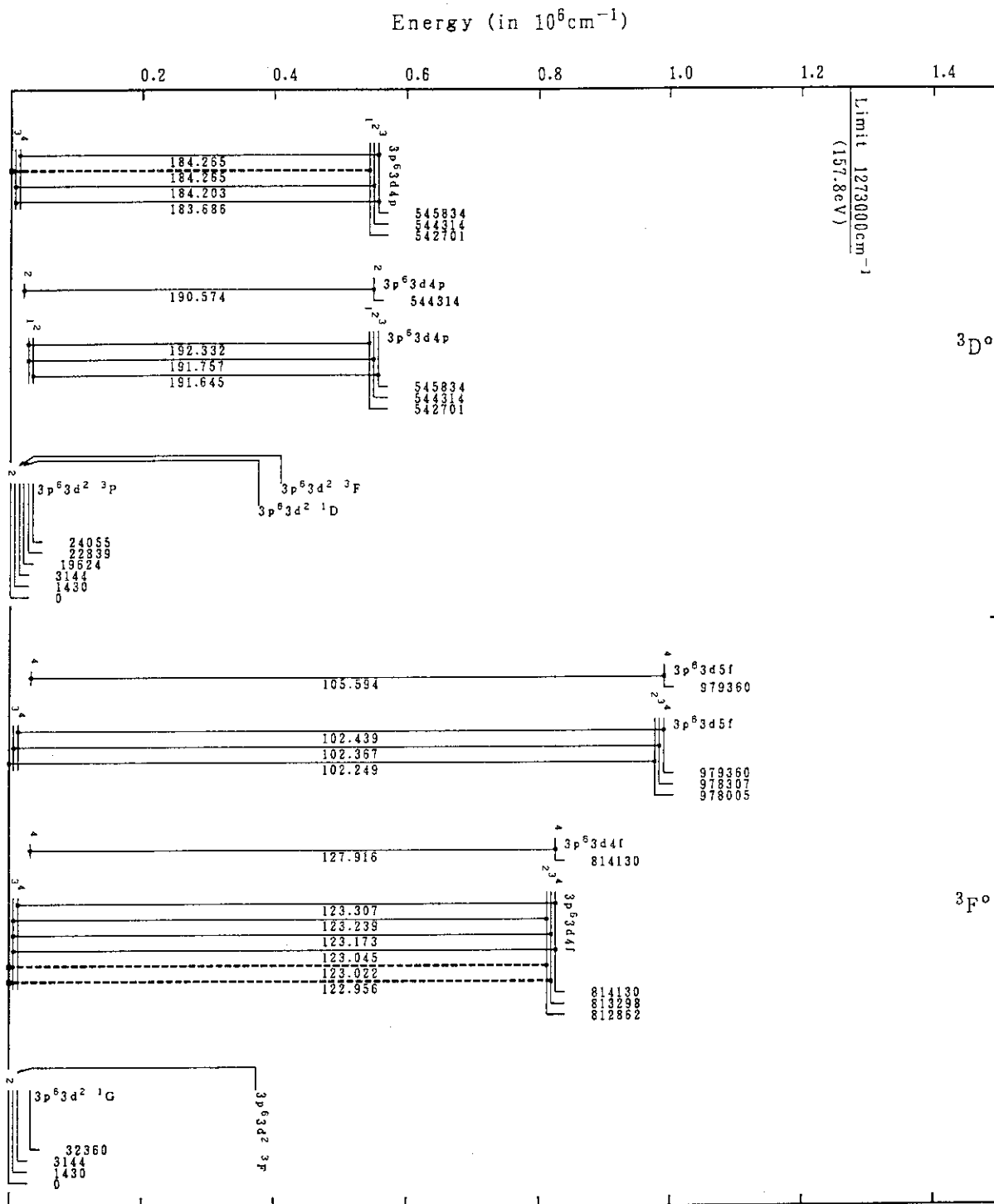

Co VIII (Ca-Sequence)

Energy (in  $10^6 \text{cm}^{-1}$ )

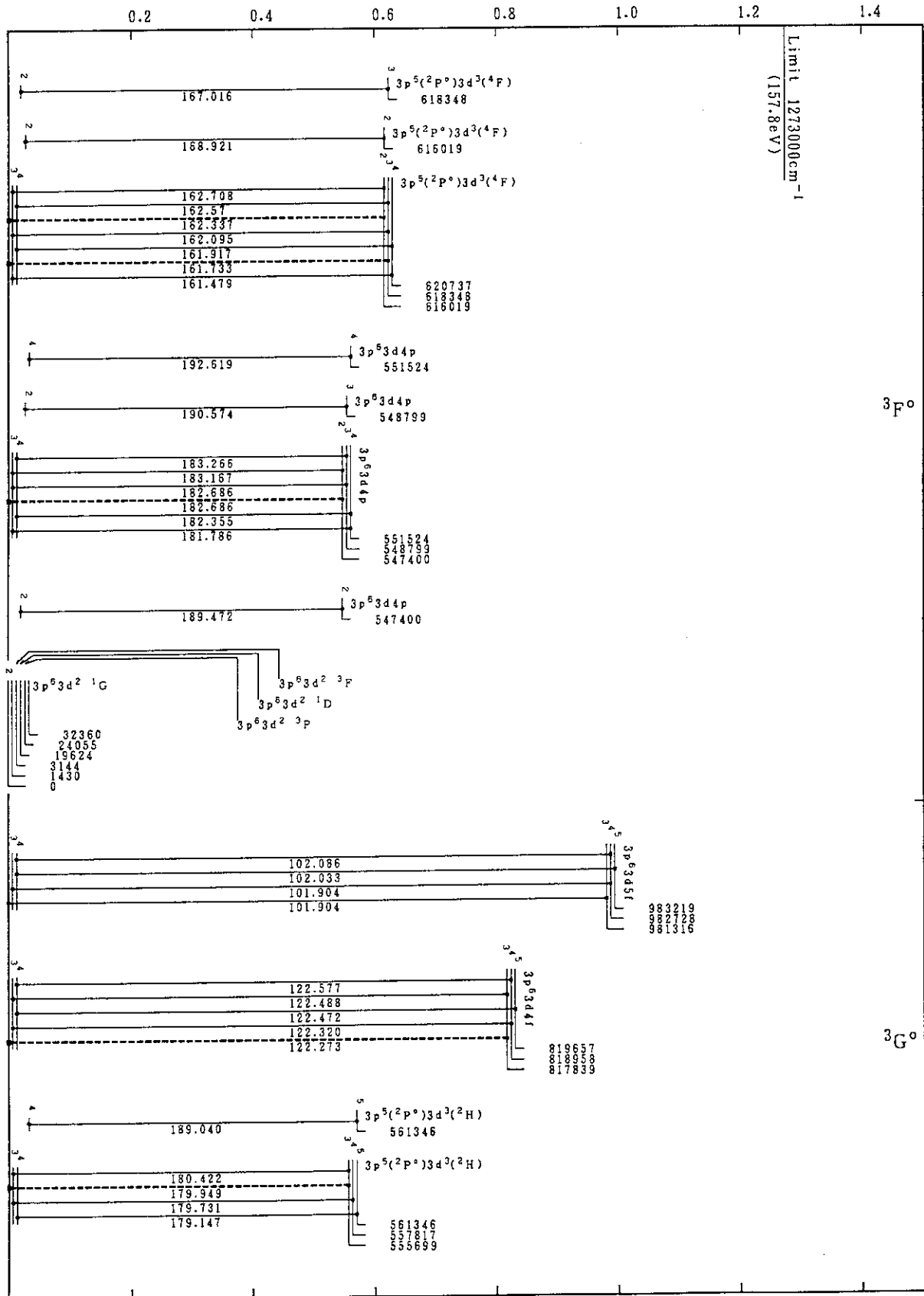

Co VIII (Ca-Sequence)

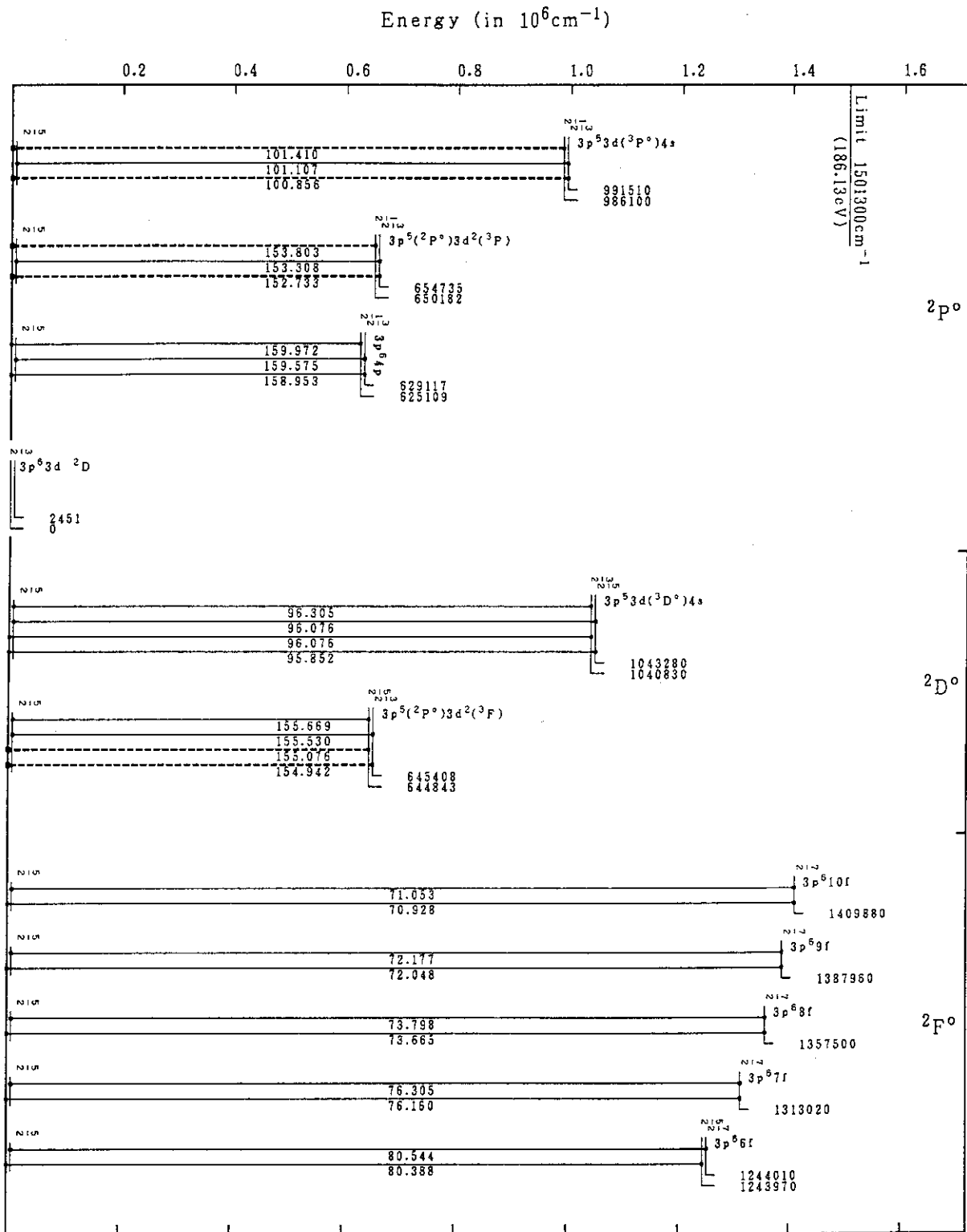

Co IX (K-Sequence)

Energy (in  $10^6 \text{cm}^{-1}$ )

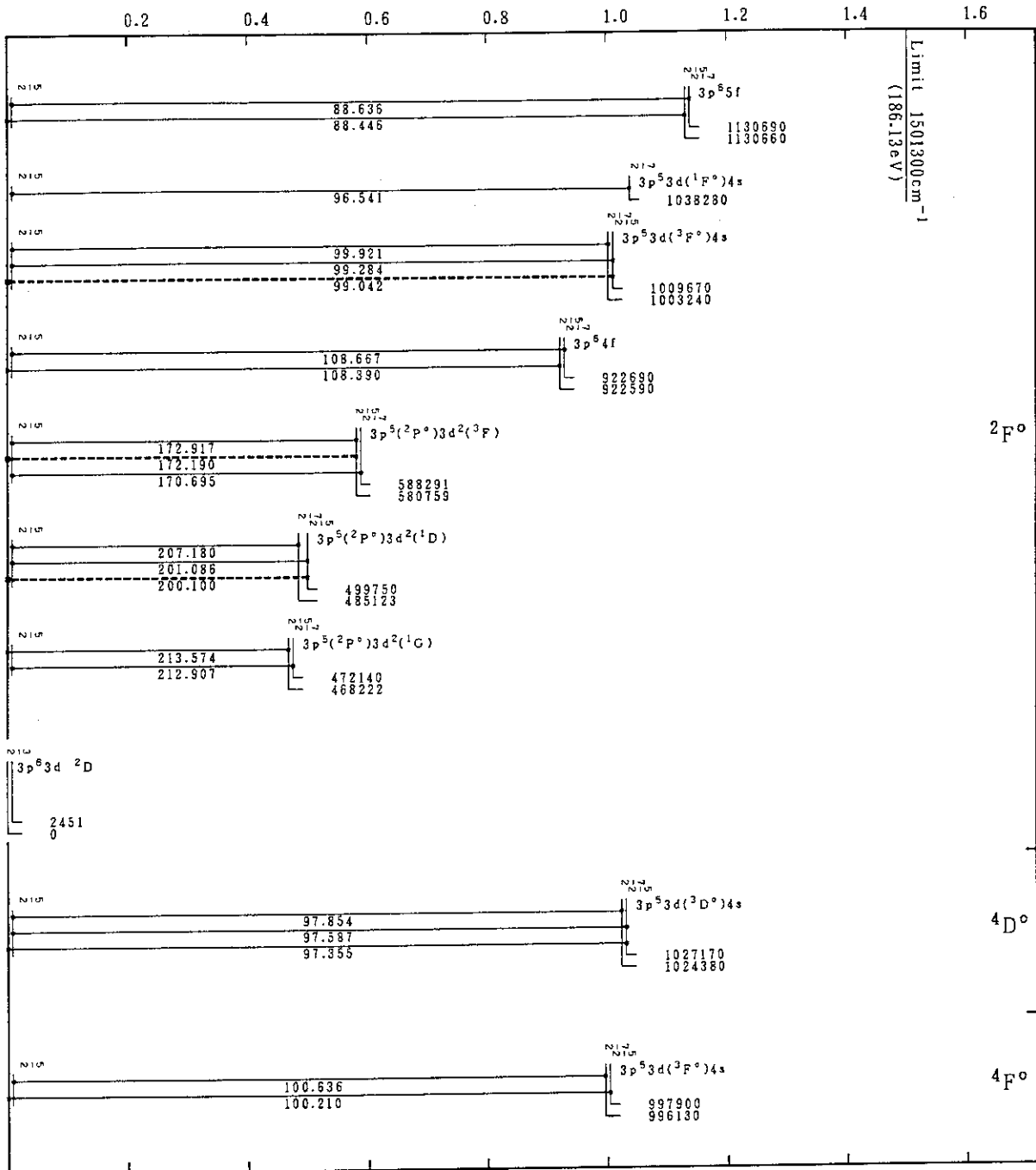

Co IX (K-Sequence)



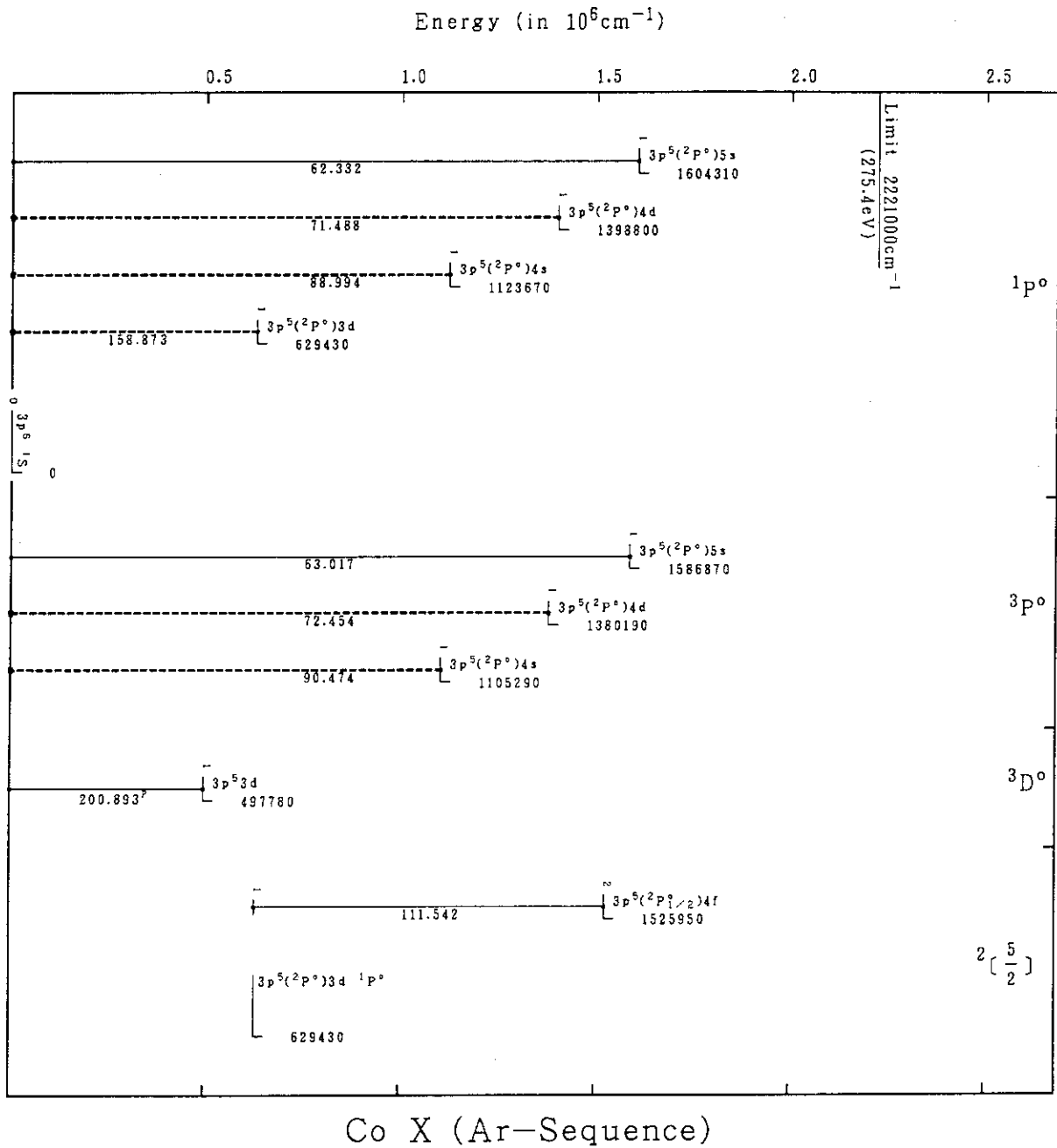

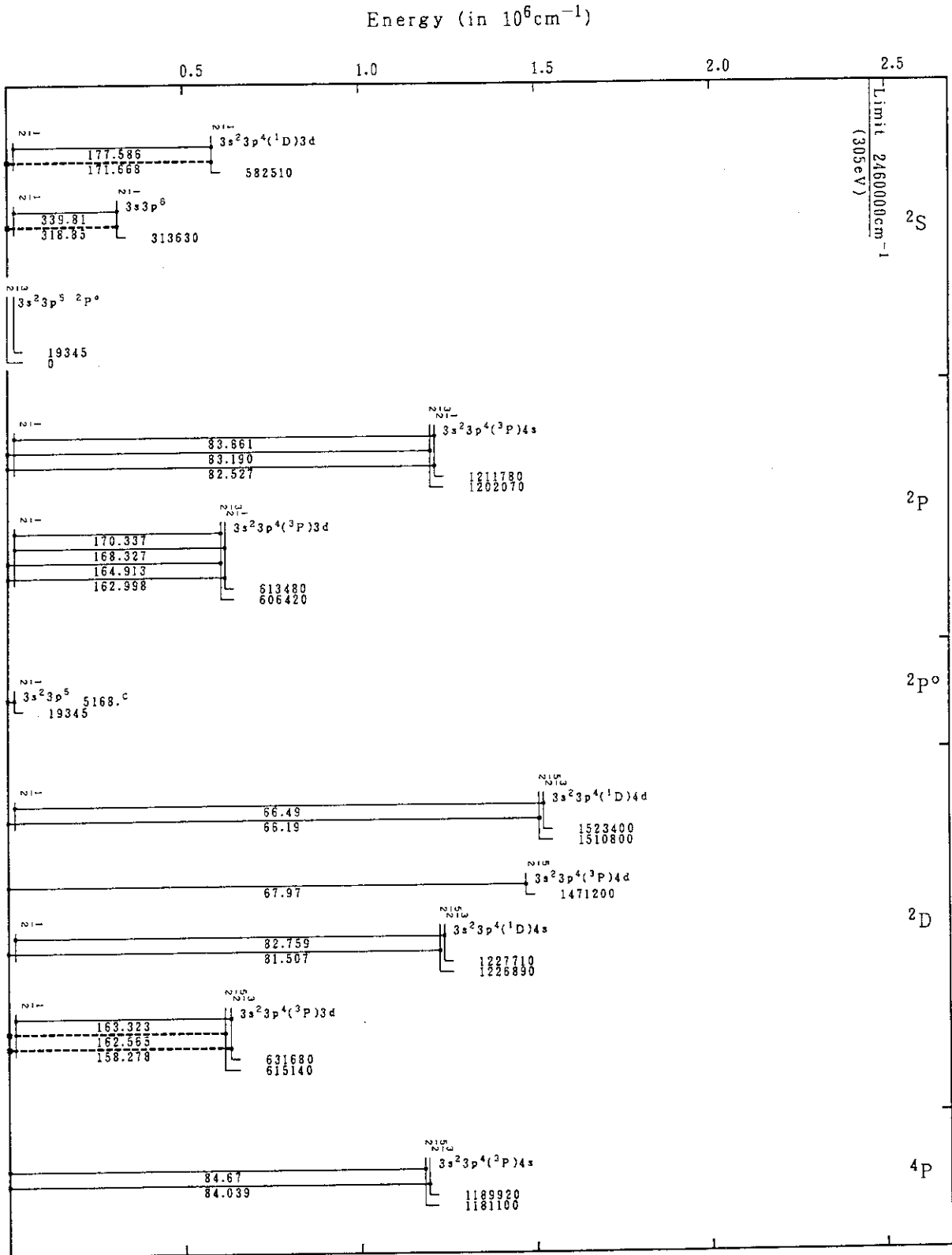

Co XI (Cl-Sequence)

Energy (in  $10^6 \text{cm}^{-1}$ )

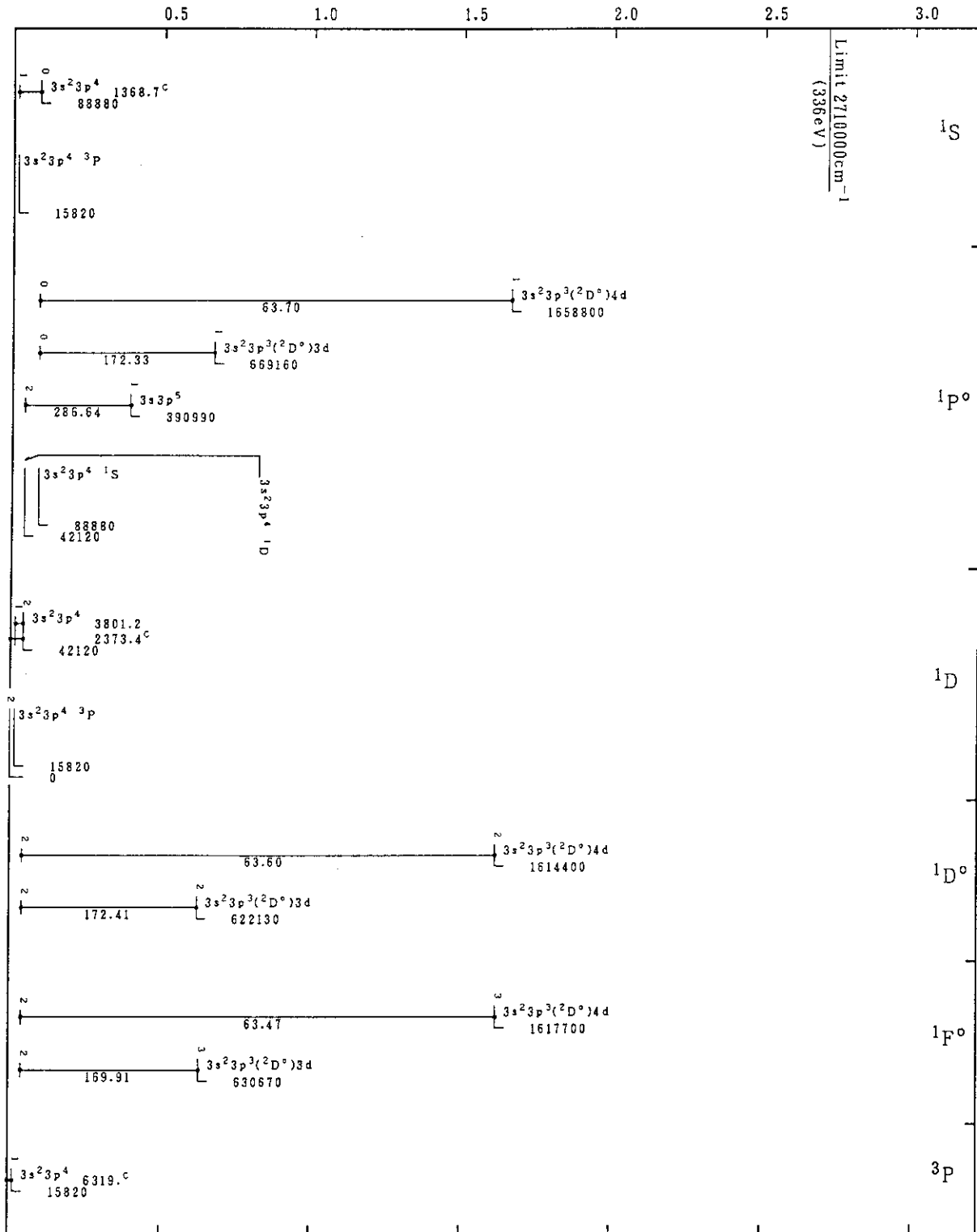

Co XII (S-Sequence)

Energy (in  $10^6 \text{cm}^{-1}$ )

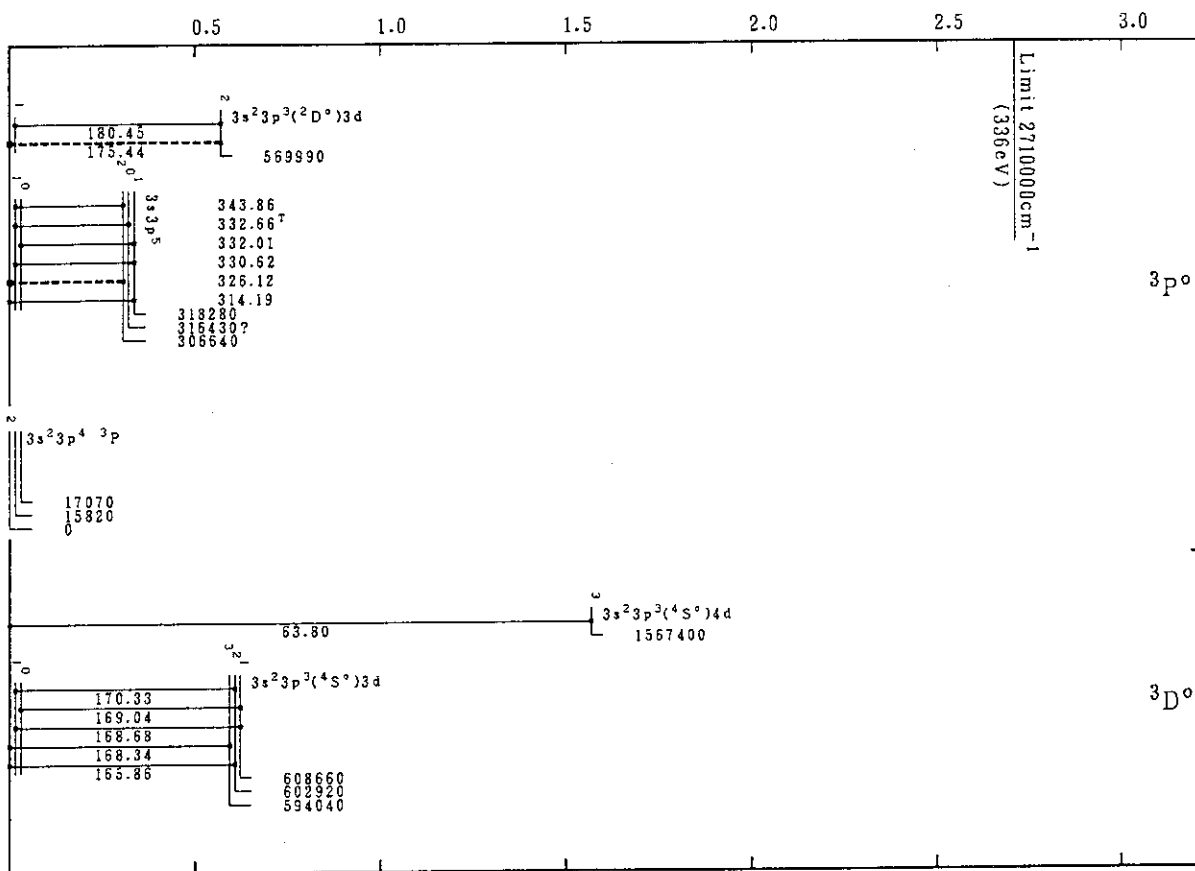

Co XII (S-Sequence)

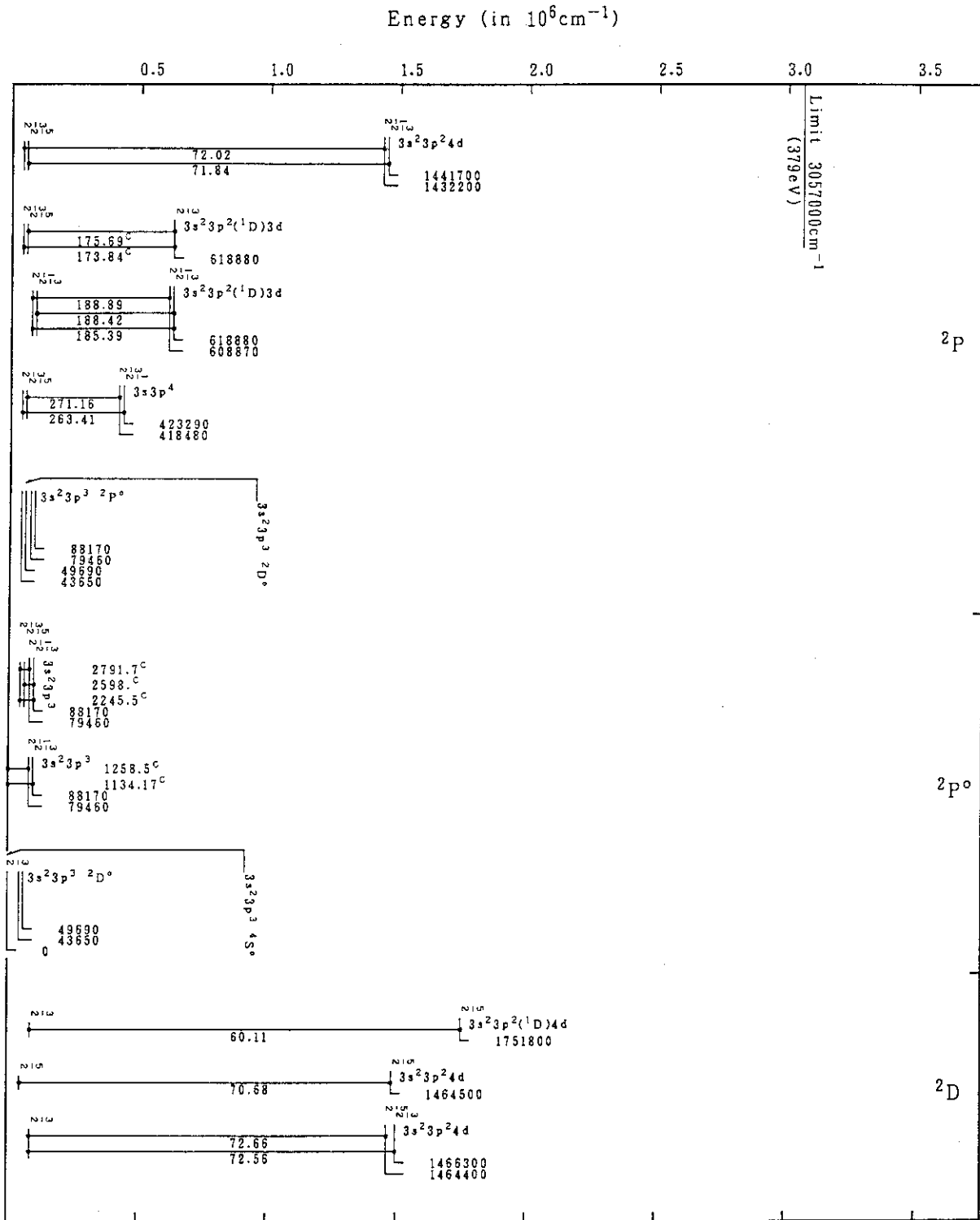

Co XIII (P-Sequence)

Energy (in  $10^6 \text{cm}^{-1}$ )

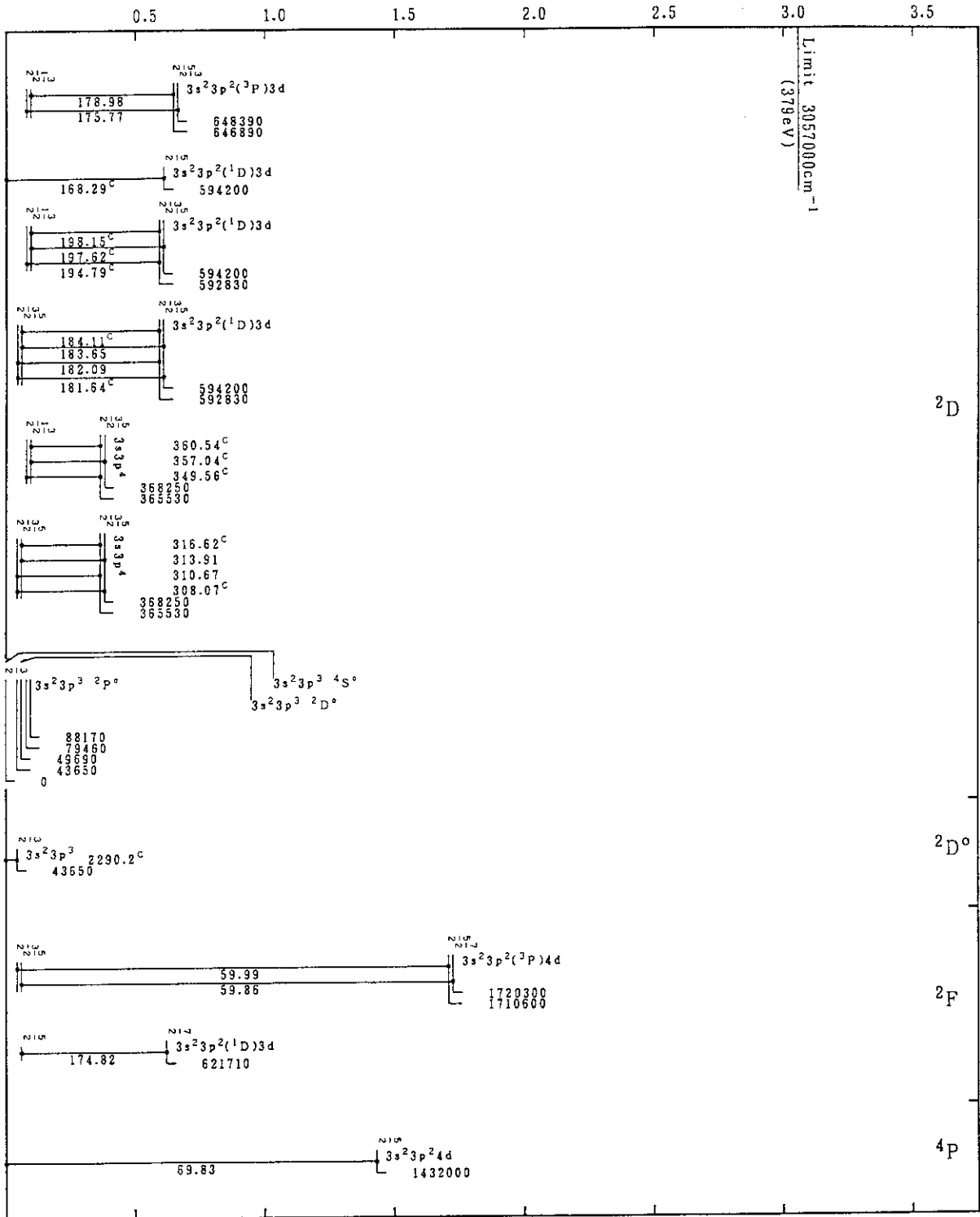

Co XIII (P-Sequence)

Energy (in  $10^6 \text{cm}^{-1}$ )

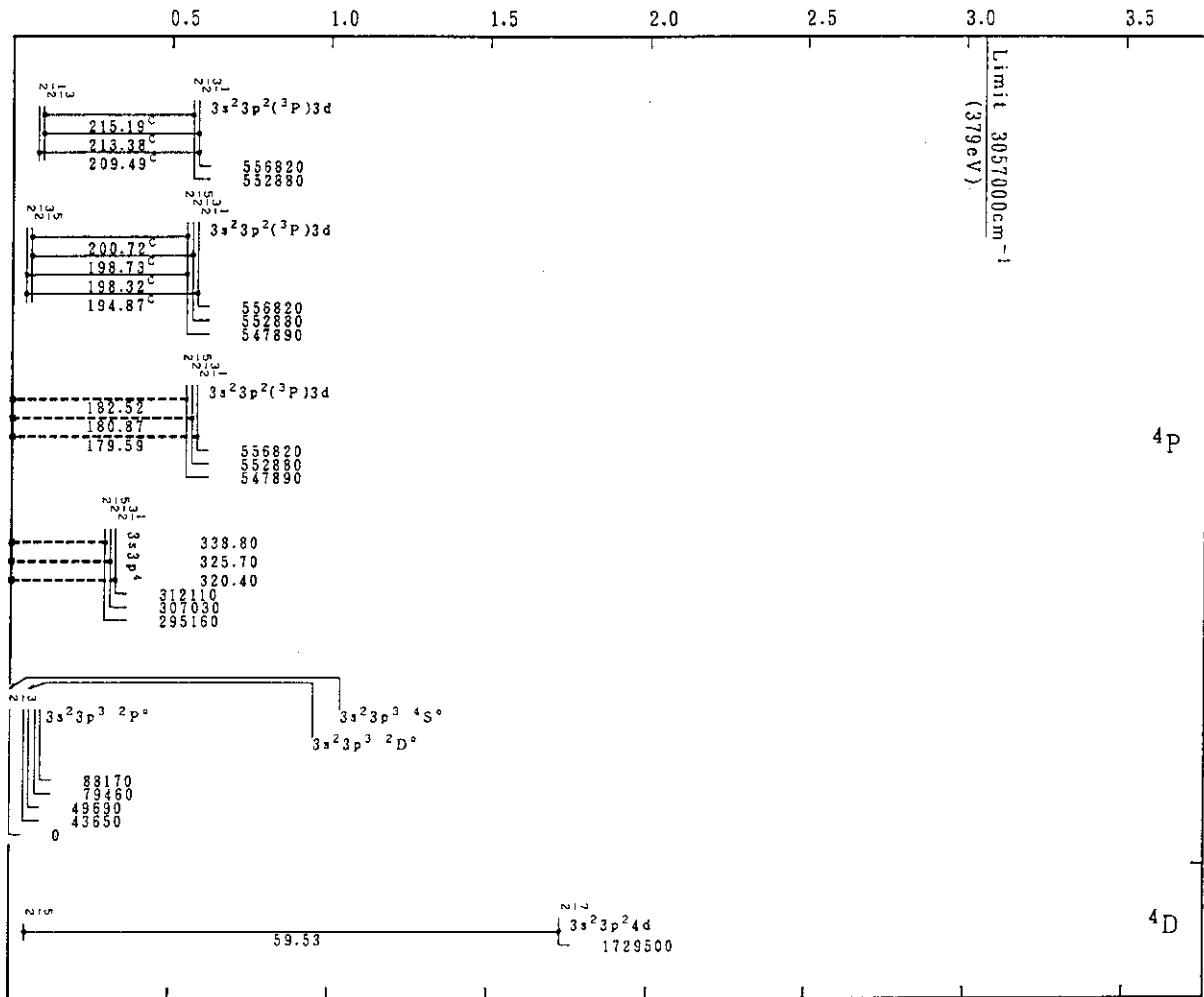

Co XIII (P-Sequence)

Energy (in  $10^6 \text{cm}^{-1}$ )

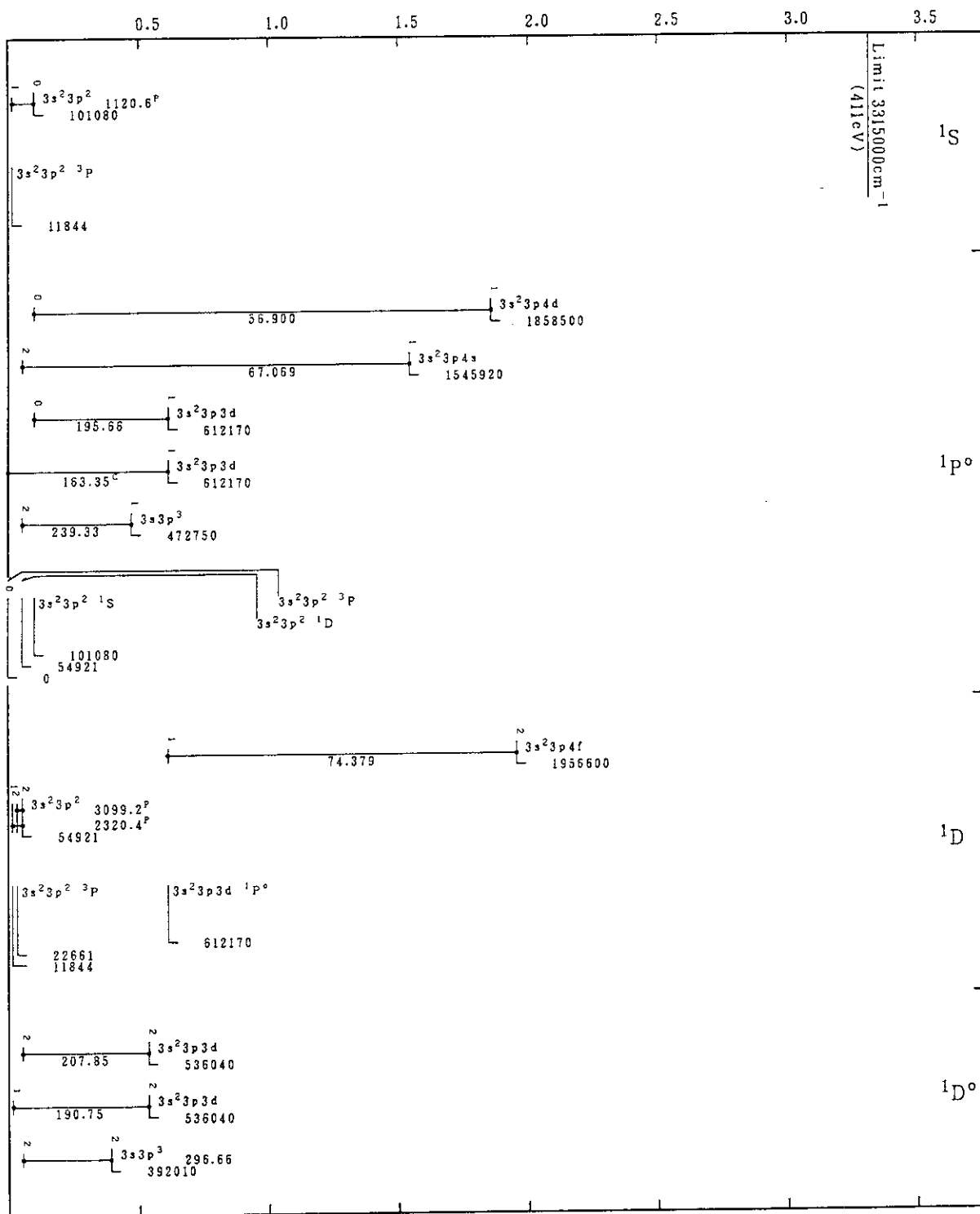

Co XIV (Si-Sequence)



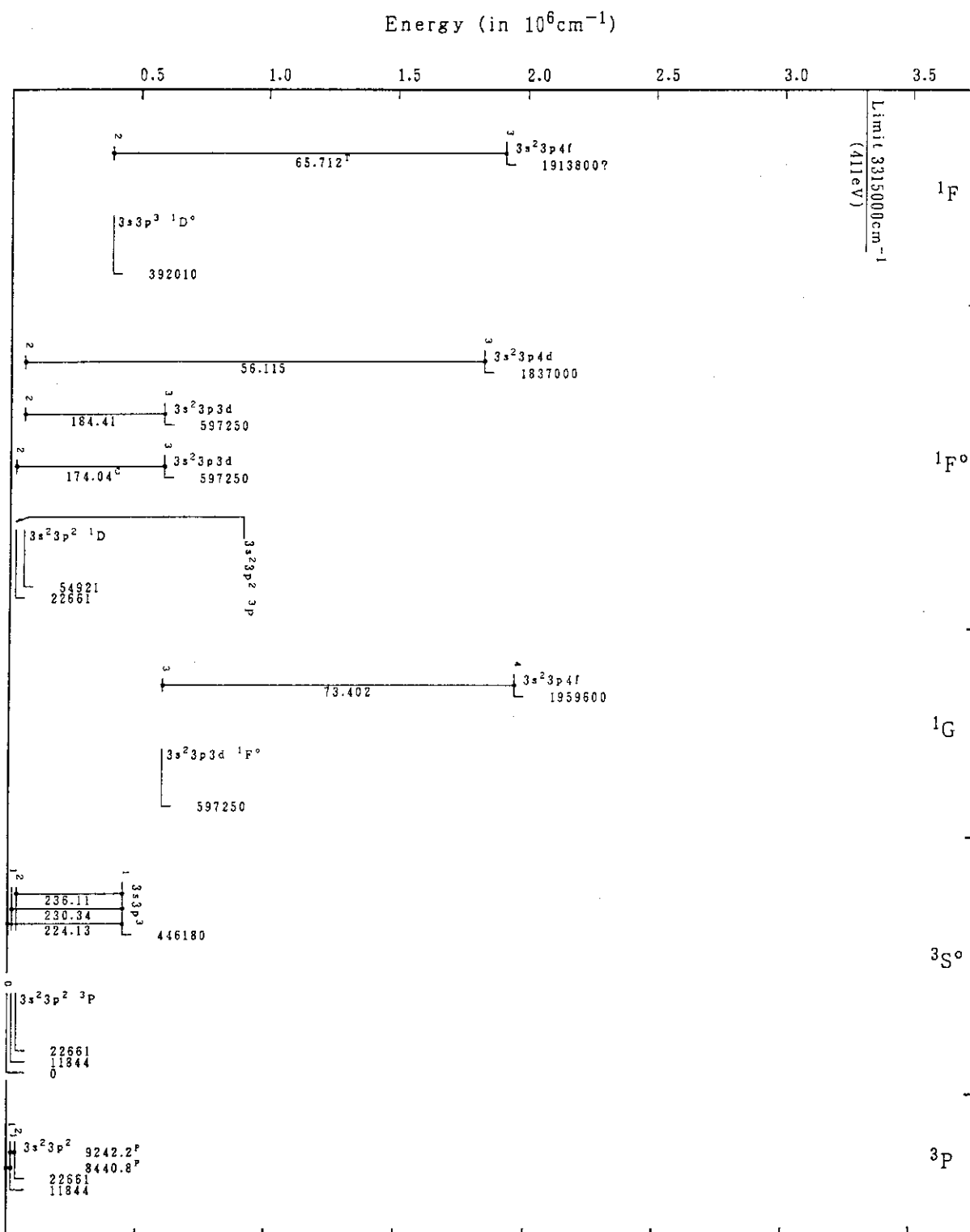

Co XIV (Si-Sequence)

Energy (in  $10^6 \text{cm}^{-1}$ )

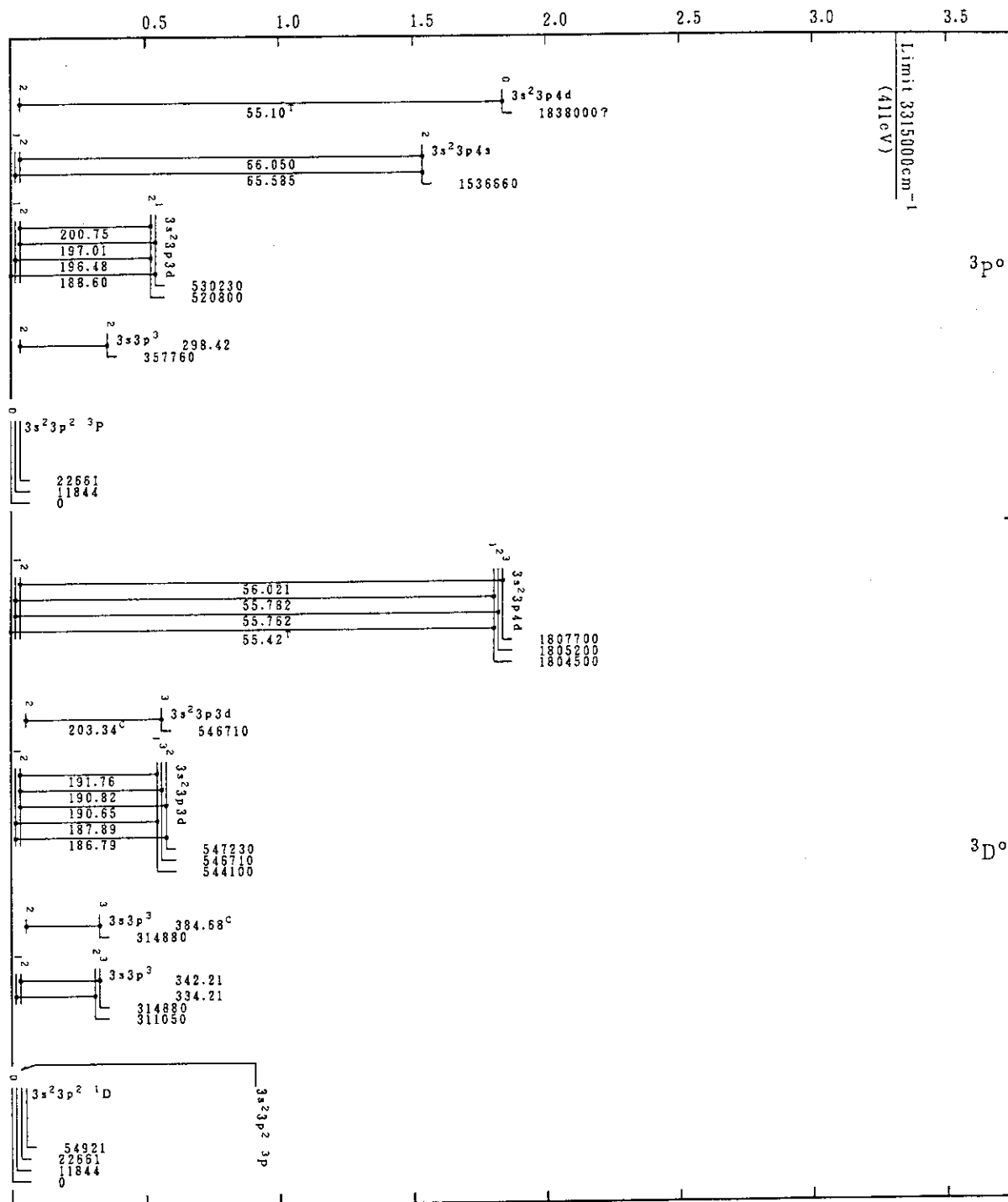

Co XIV (Si-Sequence)

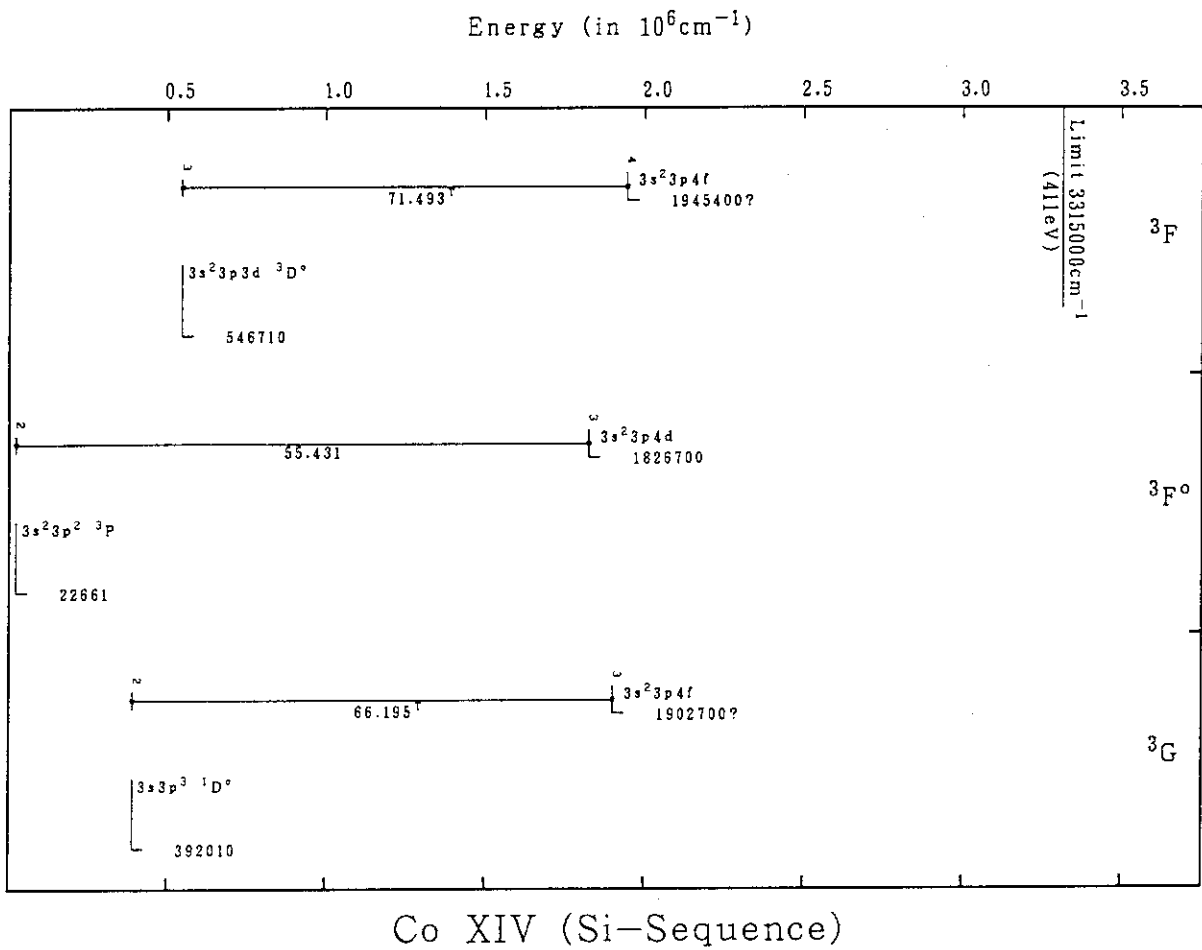

Energy (in  $10^6 \text{cm}^{-1}$ )

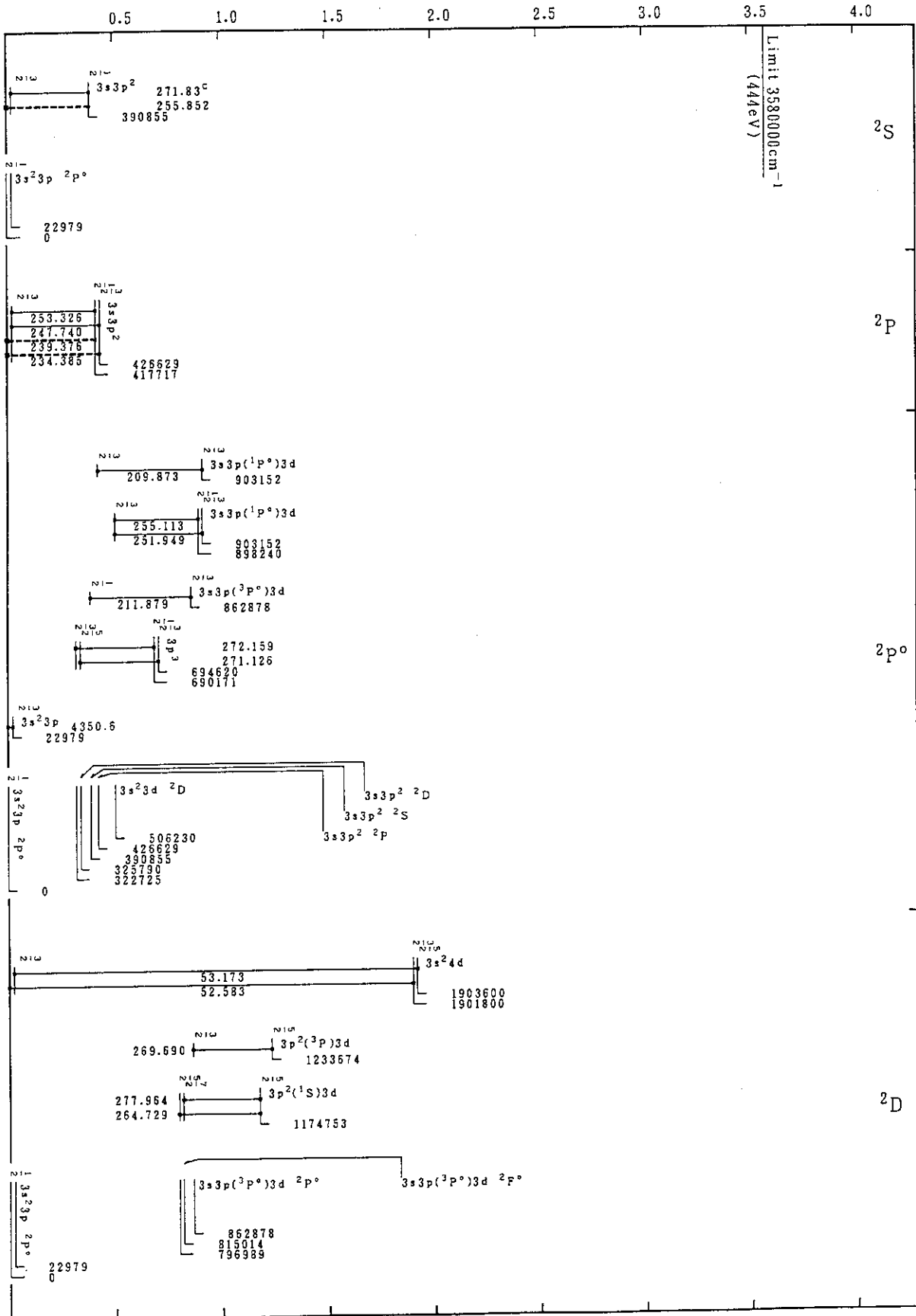

Co XV (Al-Sequence)

Energy (in  $10^6 \text{cm}^{-1}$ )

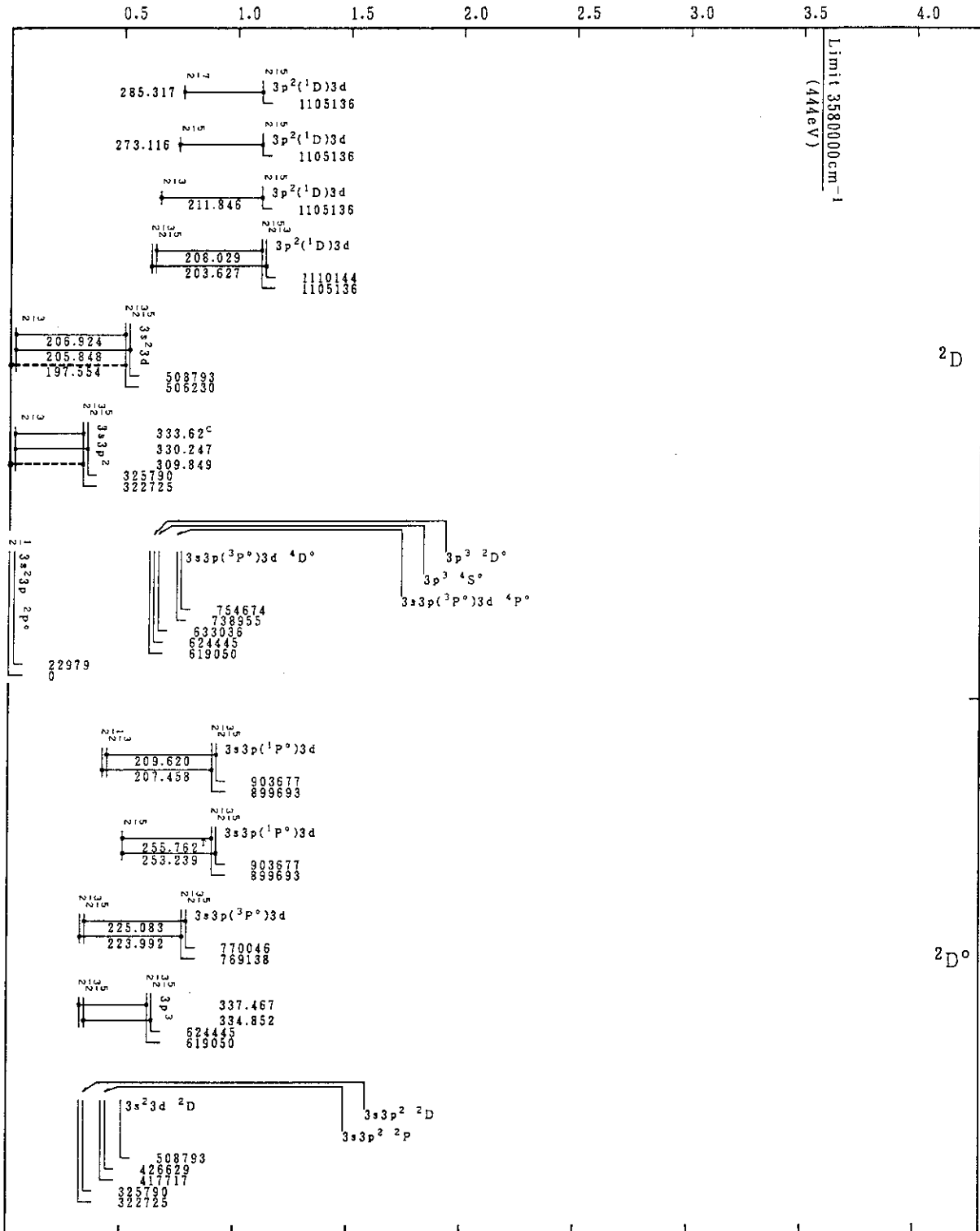

Co XV (Al-Sequence)

Energy (in  $10^6 \text{cm}^{-1}$ )

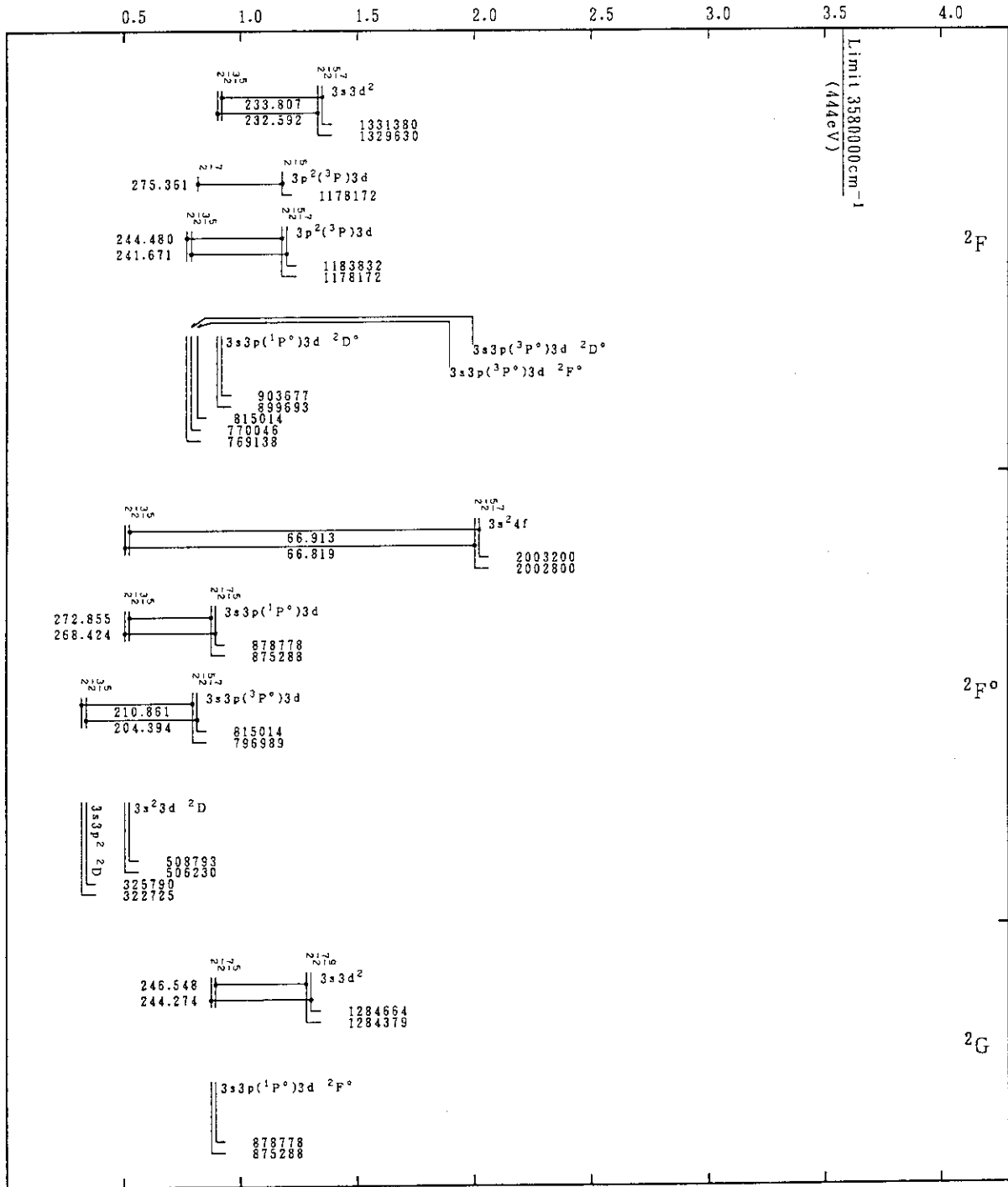

Co XV (Al-Sequence)

Energy (in  $10^6 \text{cm}^{-1}$ )

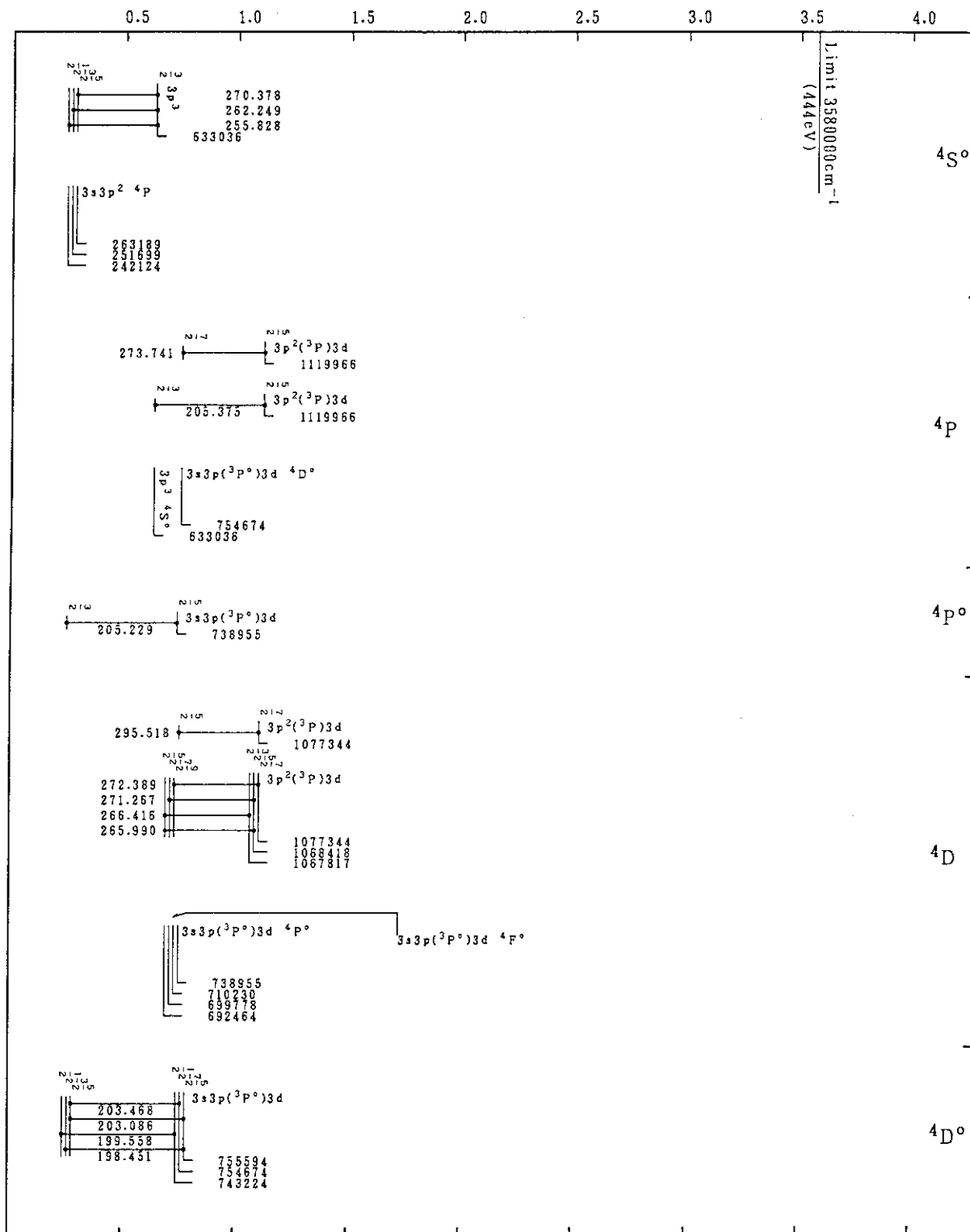

Co XV (Al-Sequence)

Energy (in  $10^6 \text{cm}^{-1}$ )

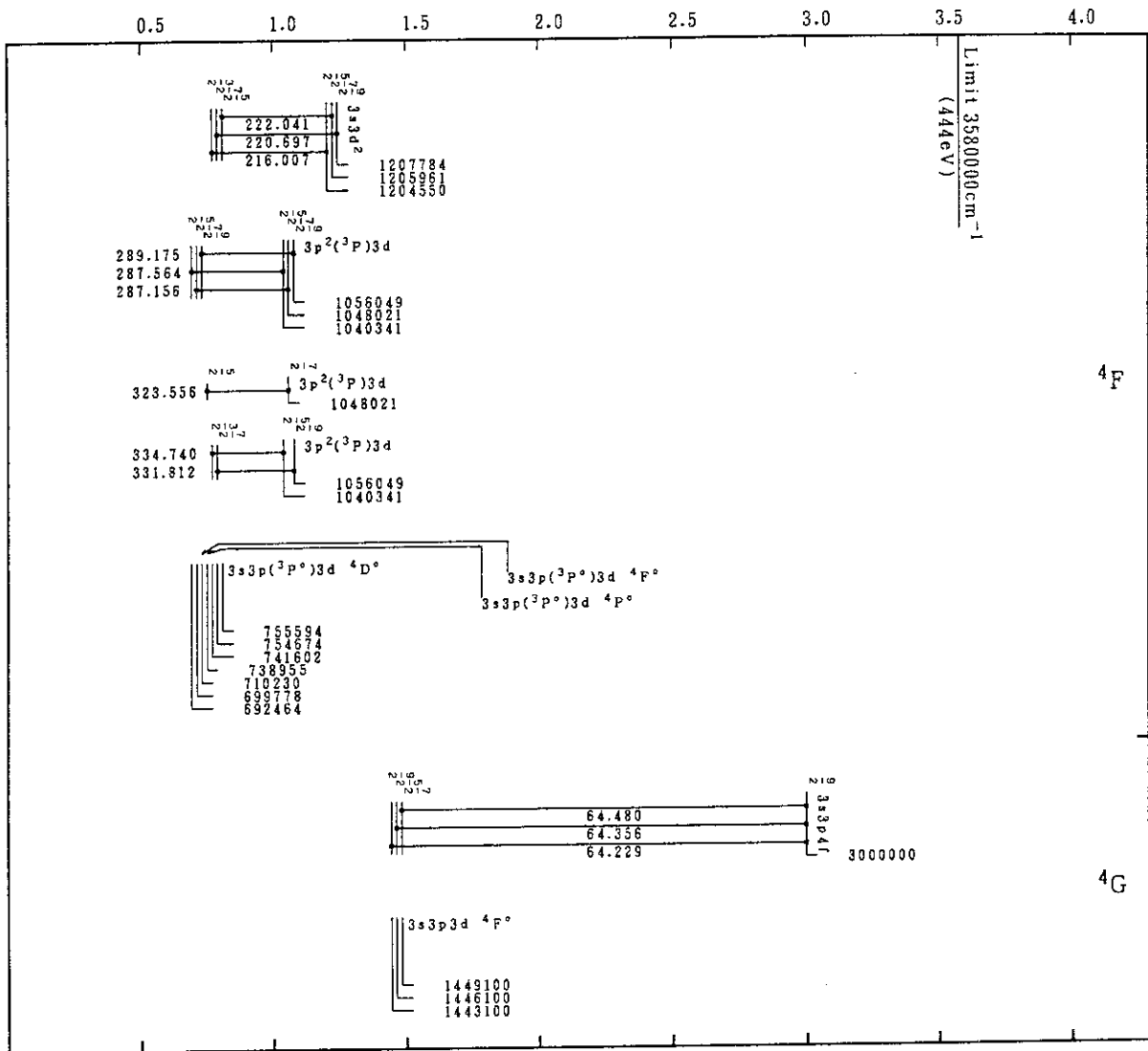

Co XV (Al-Sequence)



Energy (in  $10^6 \text{cm}^{-1}$ )

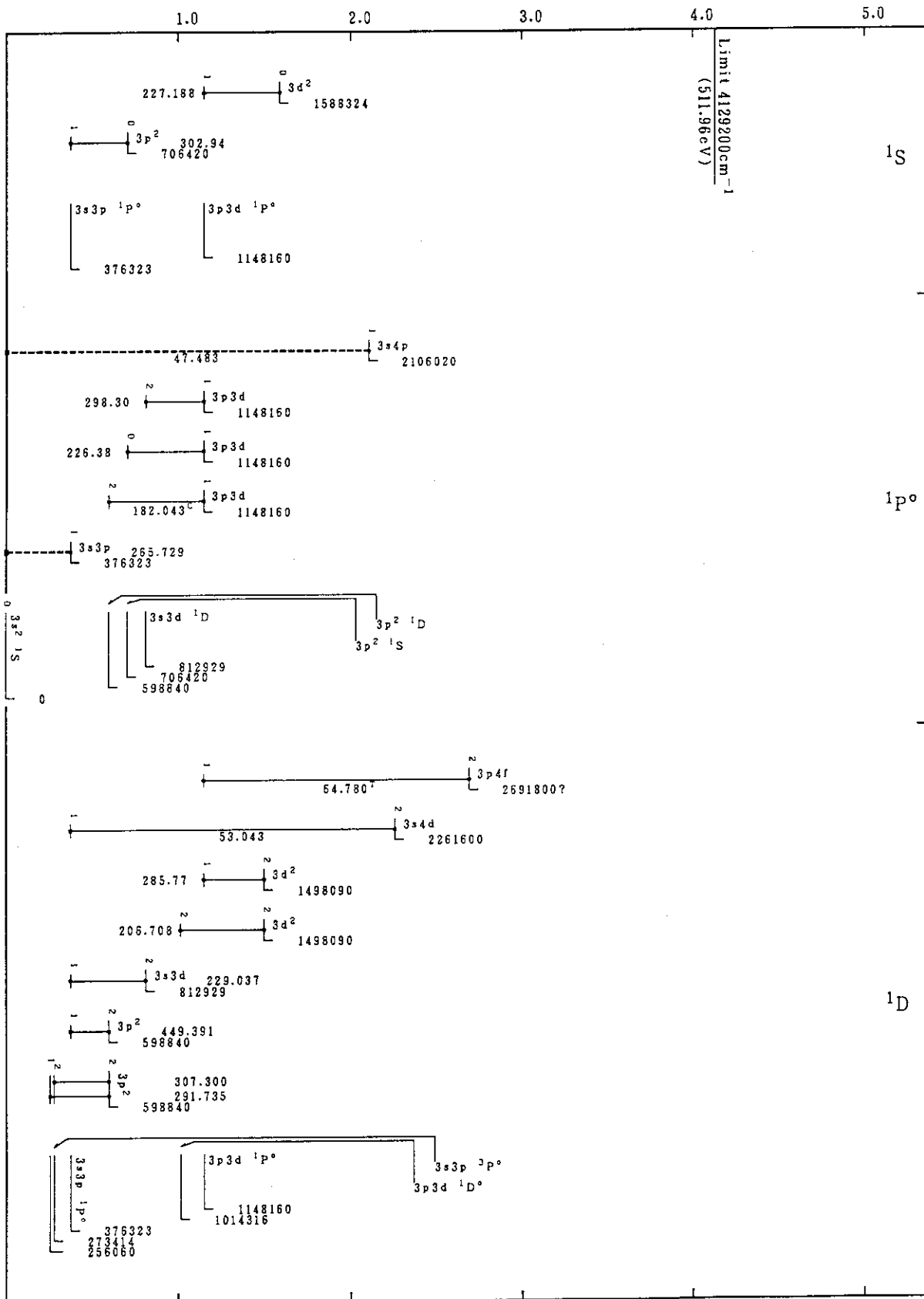

Co XVI (Mg-Sequence)

Energy (in  $10^6 \text{cm}^{-1}$ )

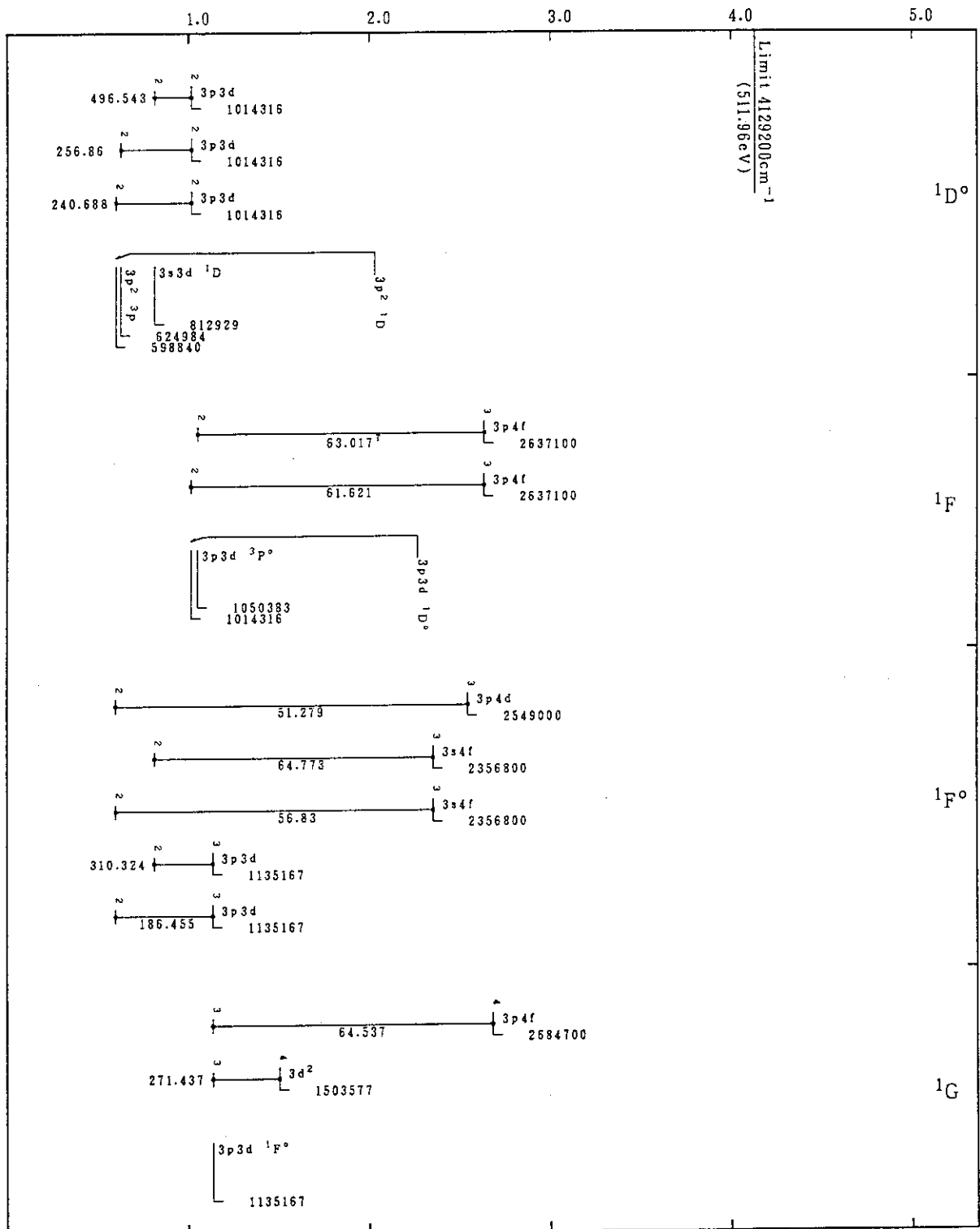

Co XVI (Mg-Sequence)



Energy (in  $10^6 \text{cm}^{-1}$ )

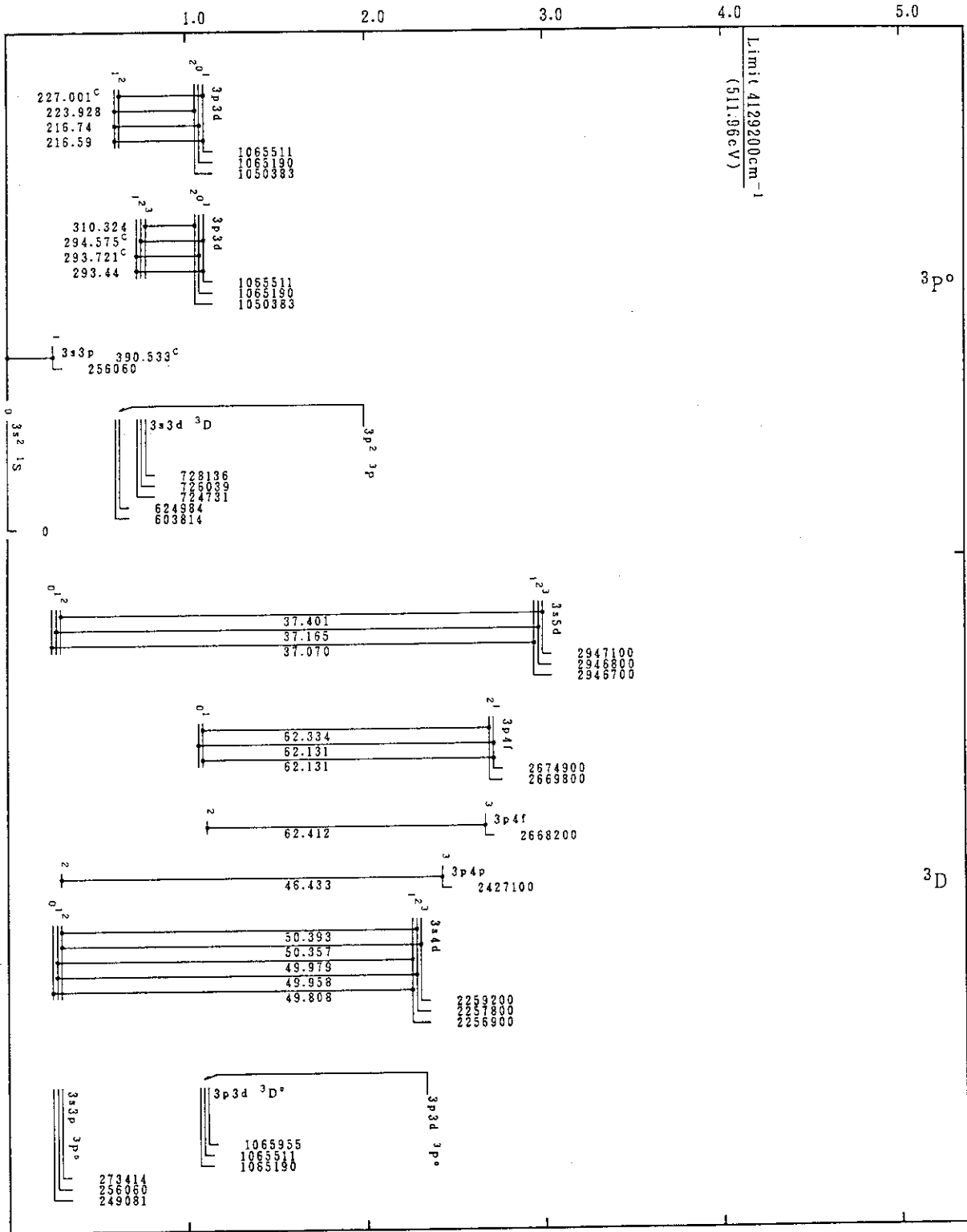

Co XVI (Mg-Sequence)

Energy (in  $10^6 \text{cm}^{-1}$ )

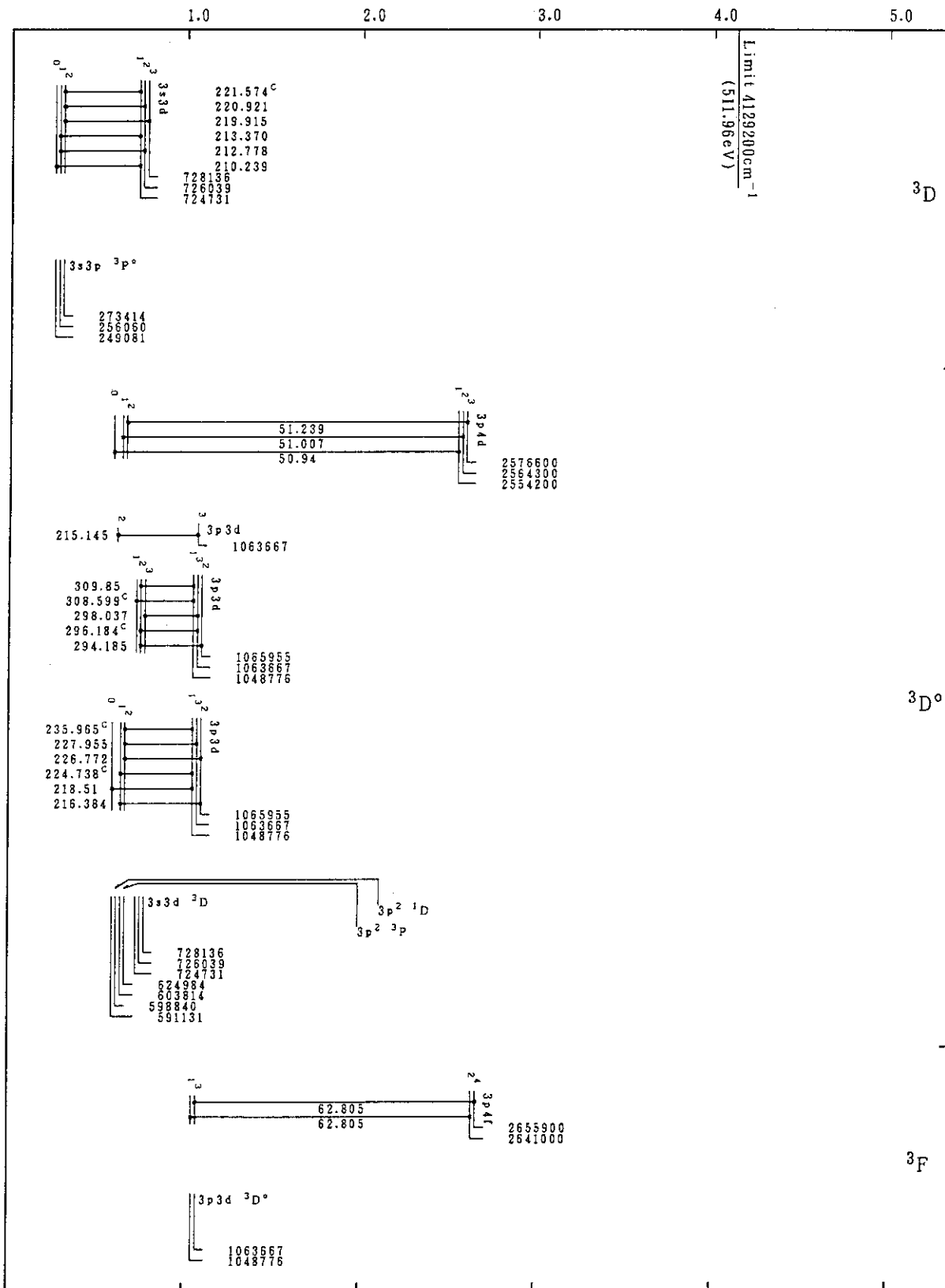

Co XVI (Mg-Sequence)

Energy (in  $10^6\text{cm}^{-1}$ )

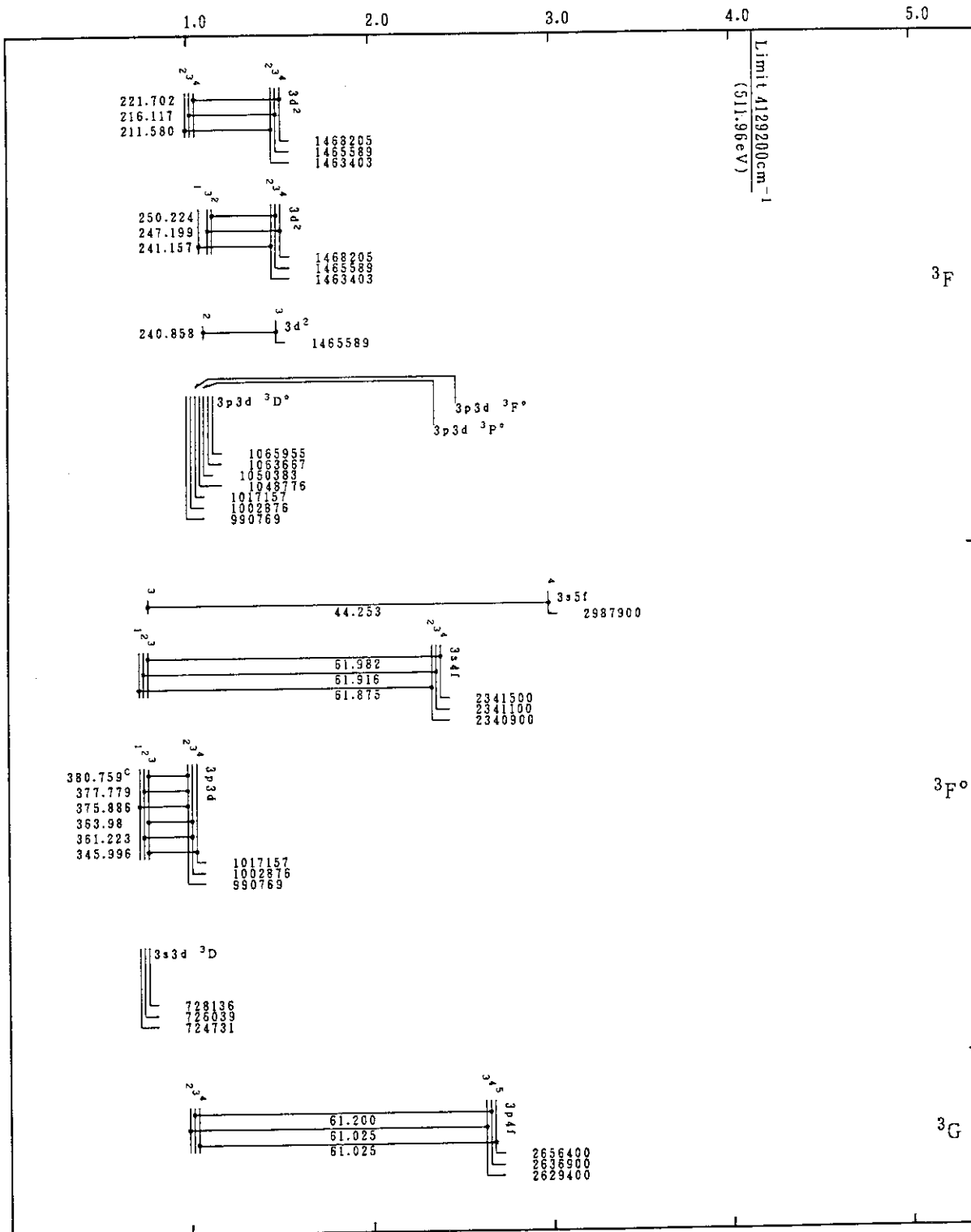

Co XVI (Mg-Sequence)

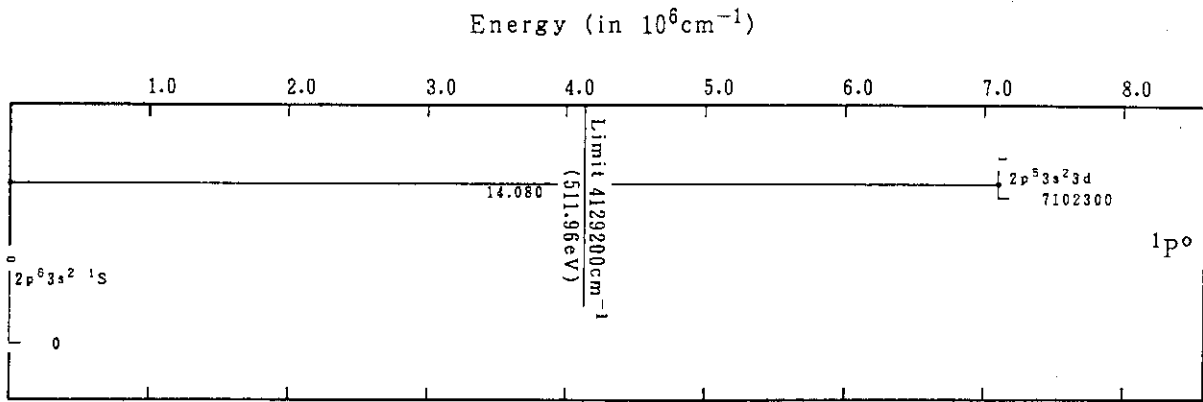

Co XVI (Mg-Sequence)

Energy (in  $10^6 \text{cm}^{-1}$ )

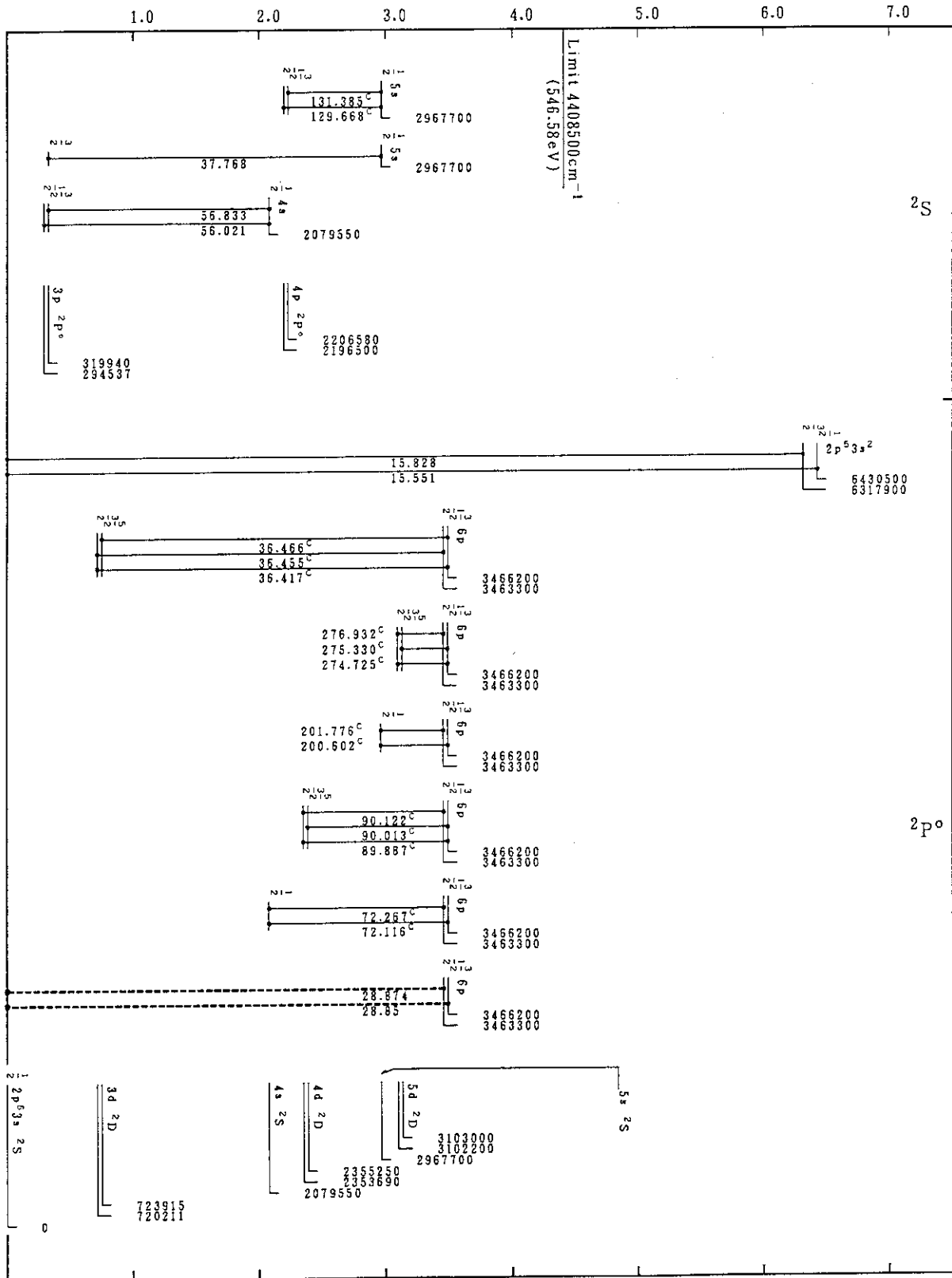

Co XVII (Na-Sequence)



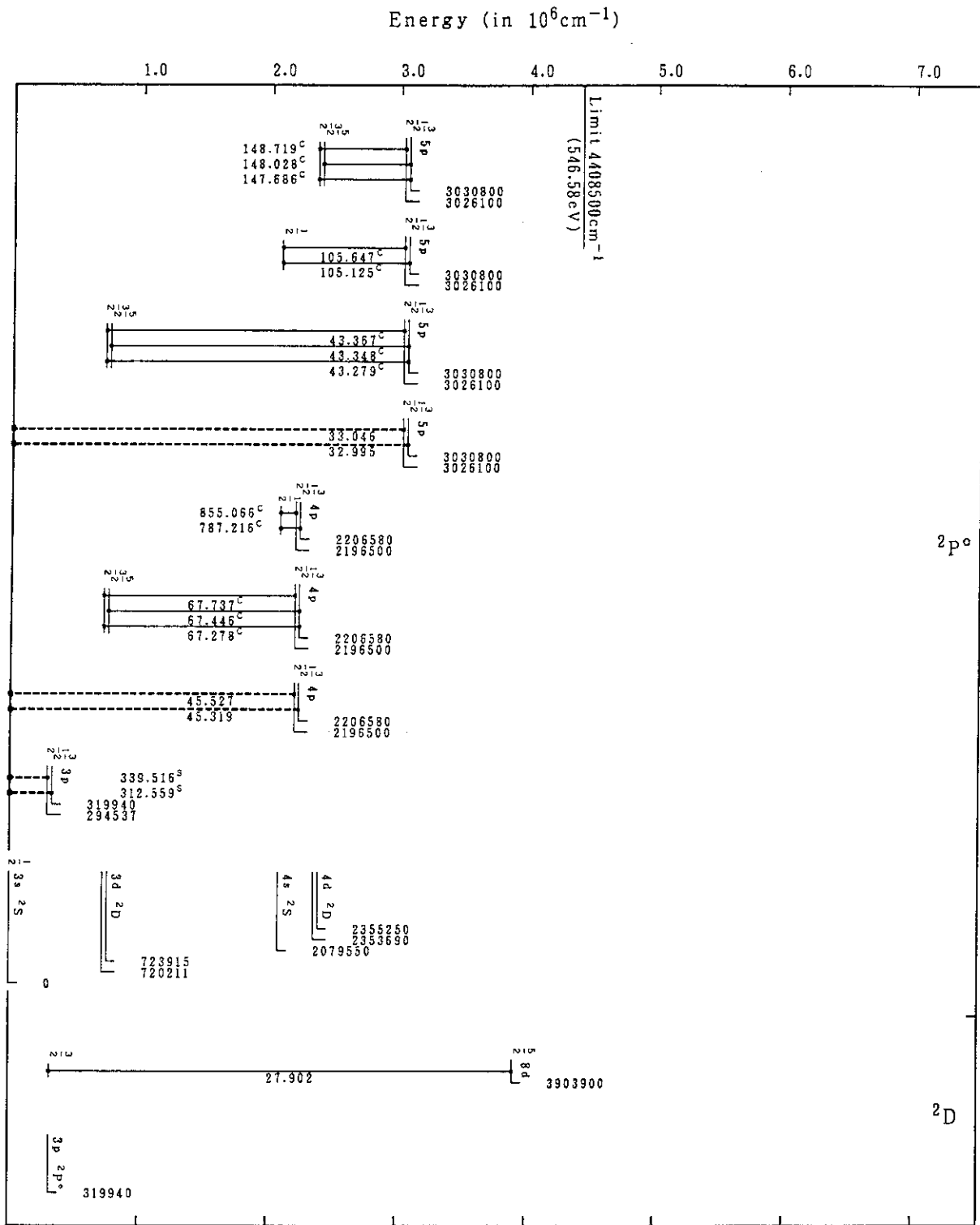

Co XVII (Na-Sequence)

Energy (in  $10^6 \text{cm}^{-1}$ )

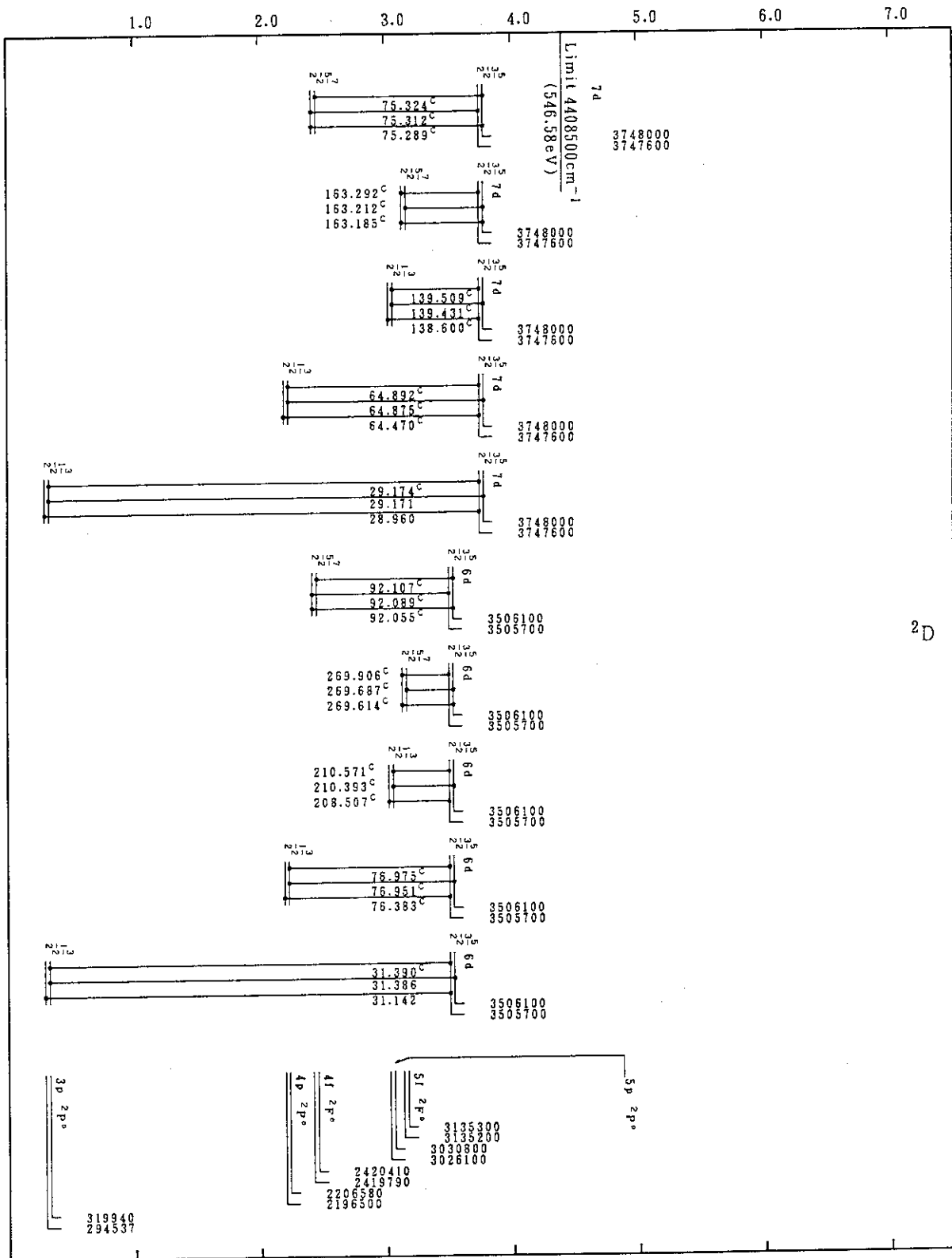

Co XVII (Na-Sequence)

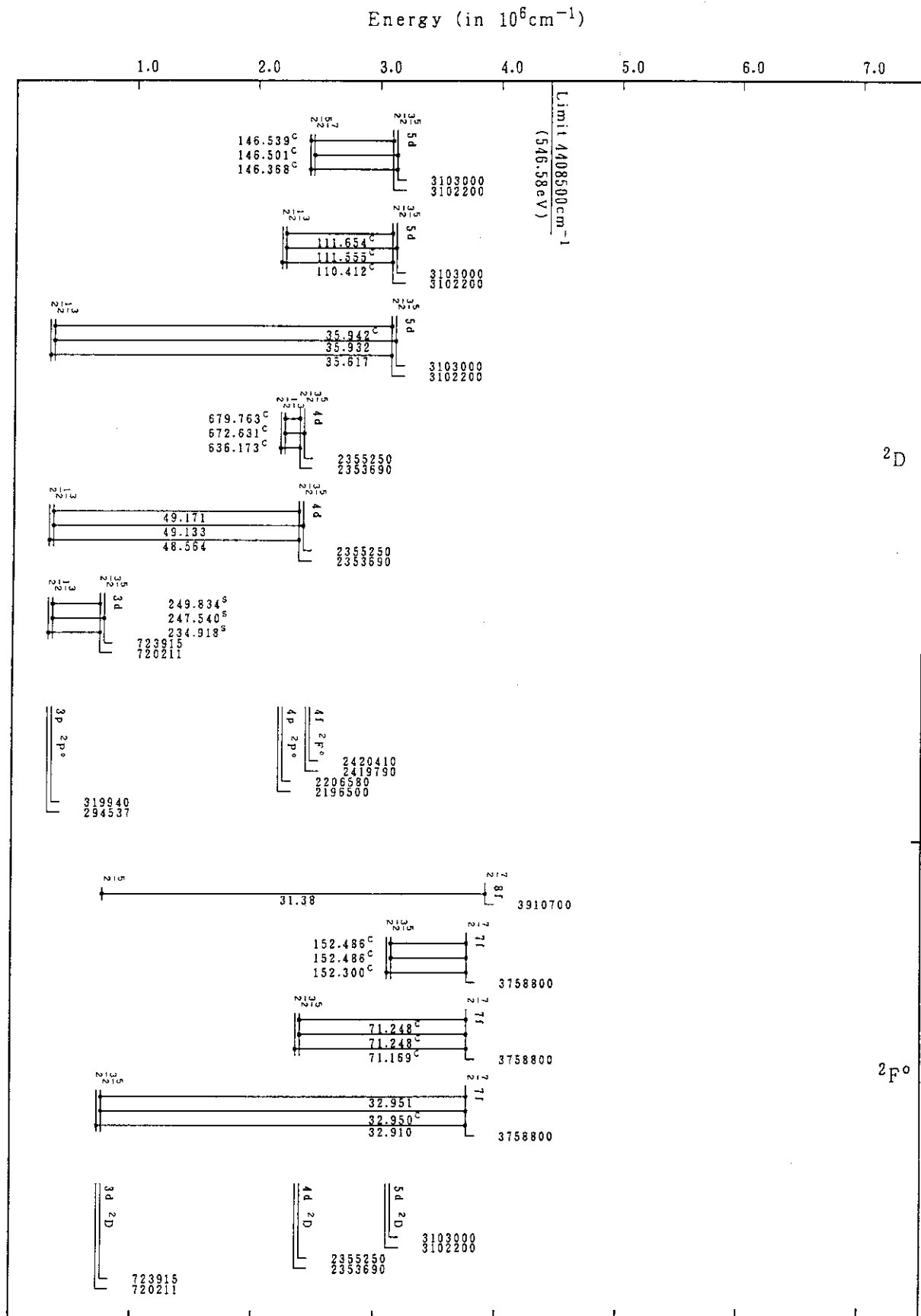

Energy (in  $10^6 \text{cm}^{-1}$ )

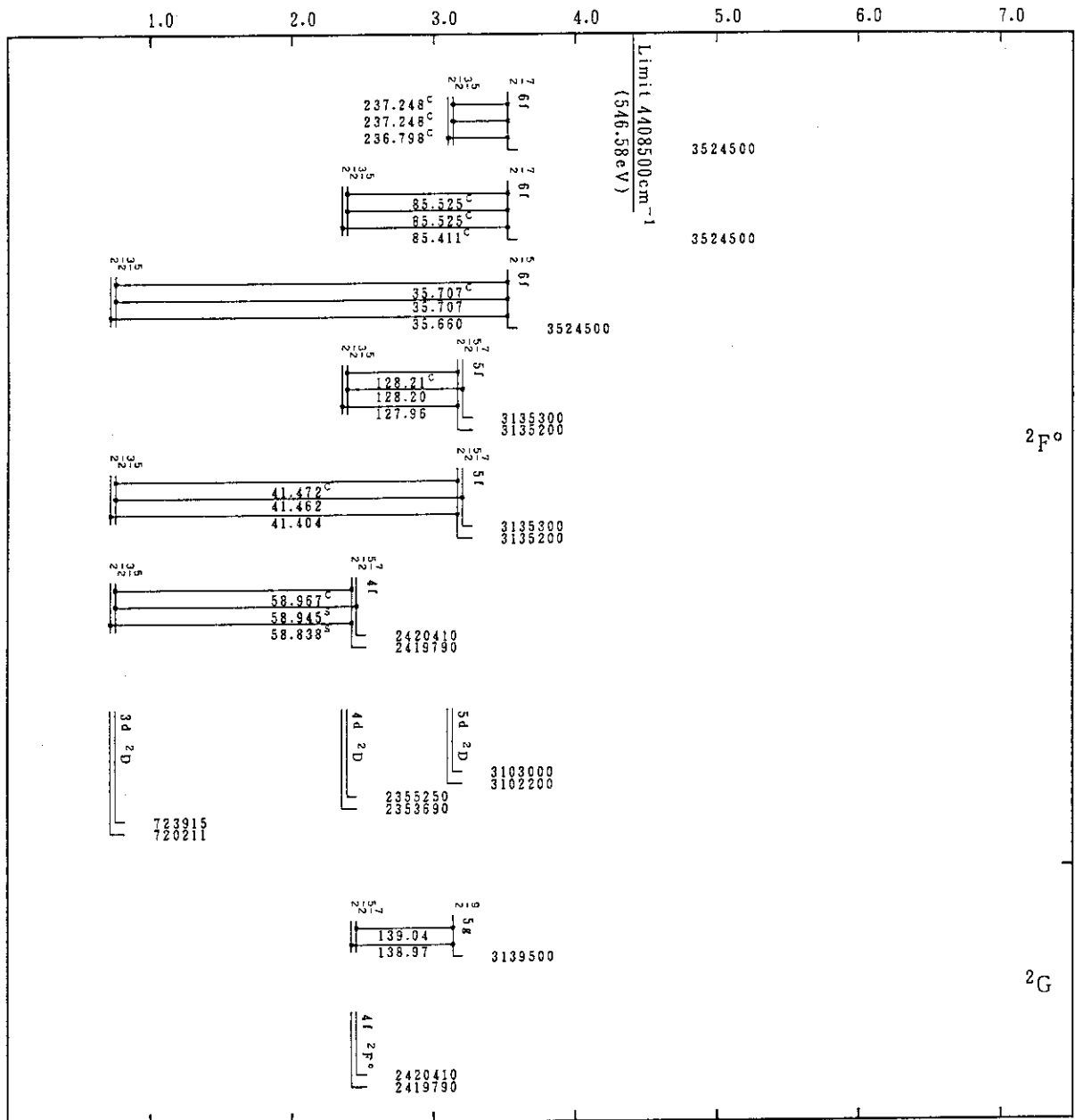

Co XVII (Na-Sequence)

Energy (in  $10^7 \text{cm}^{-1}$ )

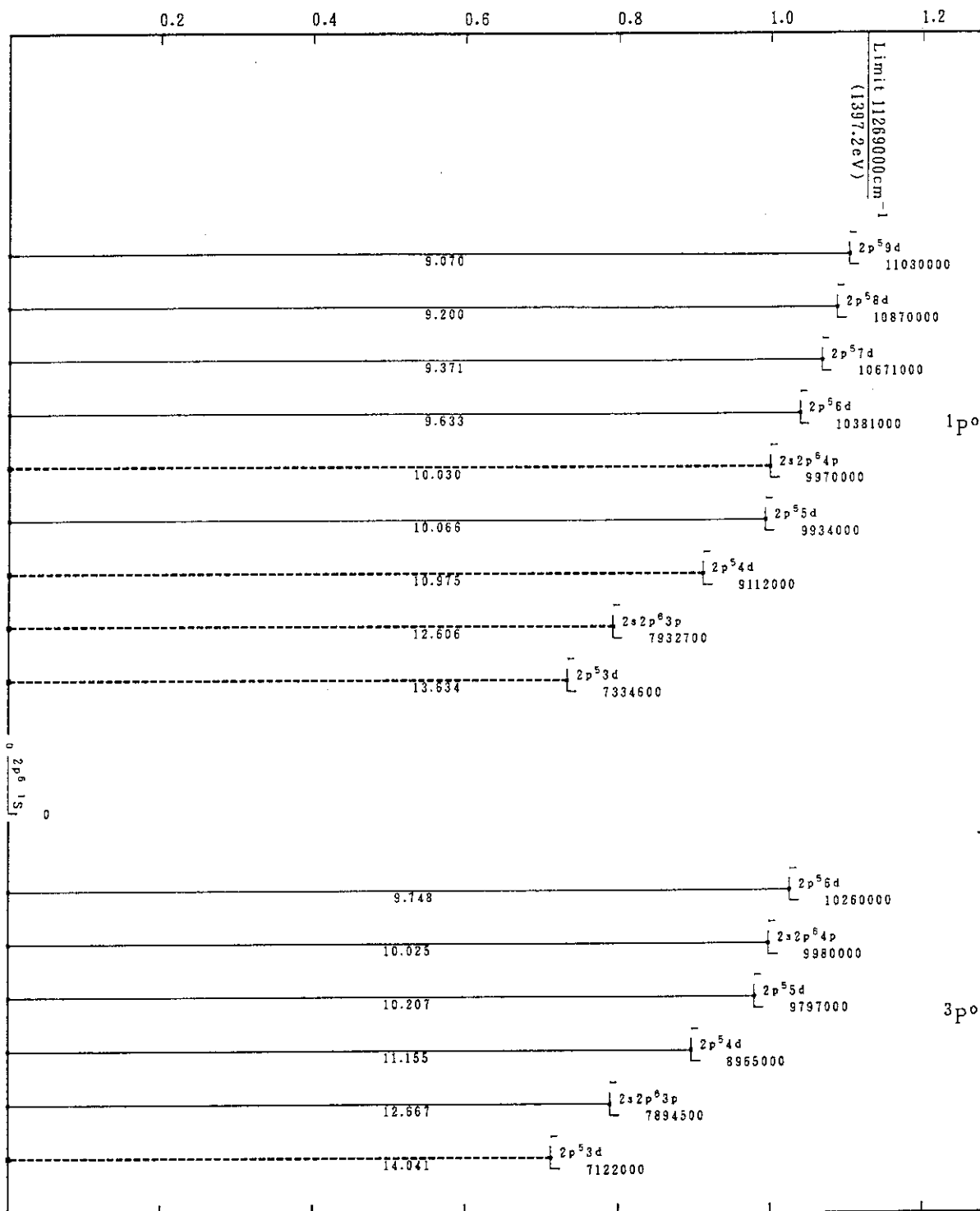

Co XVIII (Ne-Sequence)

Energy (in  $10^7 \text{cm}^{-1}$ )

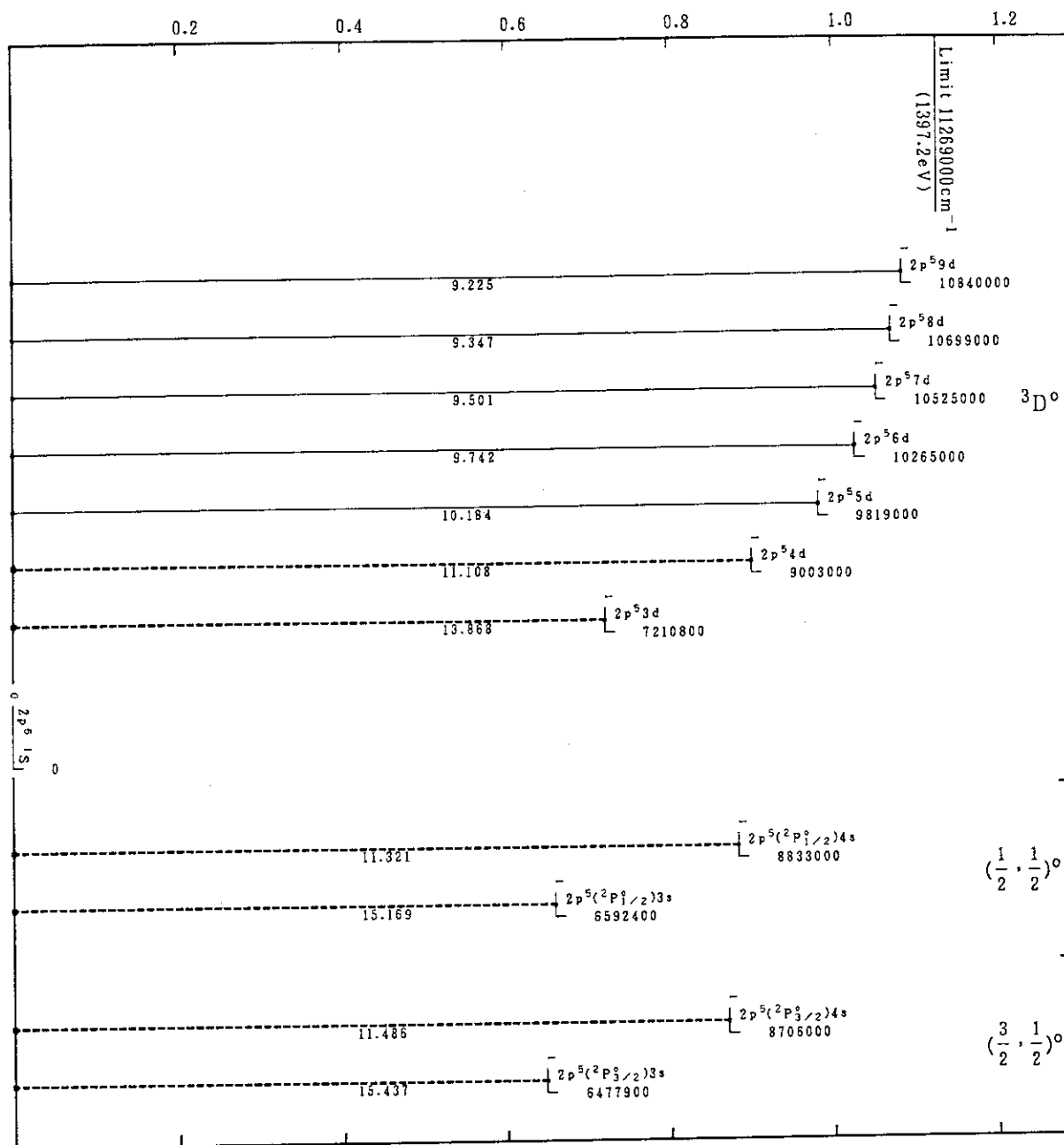

Co XVIII (Ne-Sequence)

Energy (in  $10^7 \text{cm}^{-1}$ )

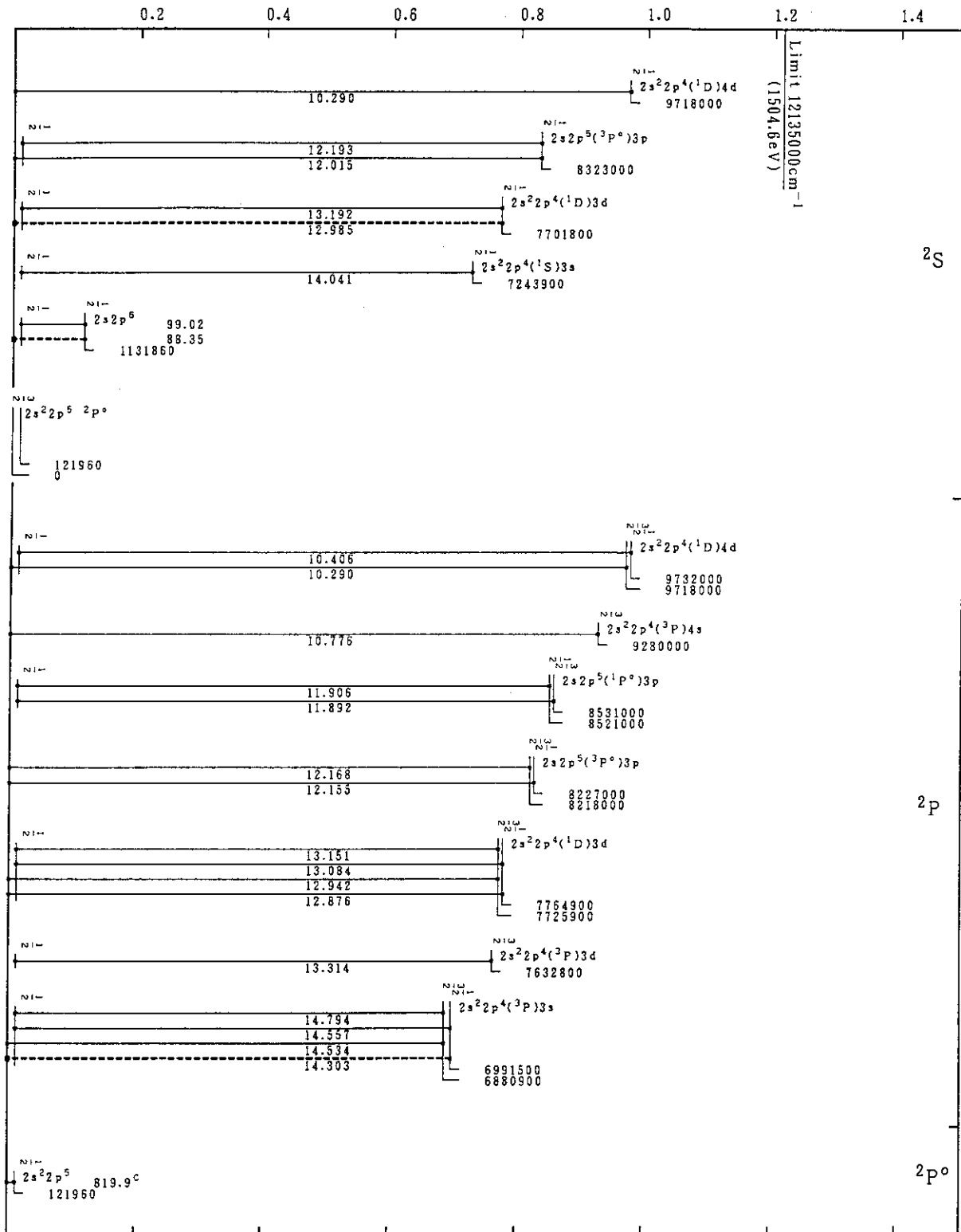

Co XIX (F-Sequence)

Energy (in  $10^7 \text{cm}^{-1}$ )

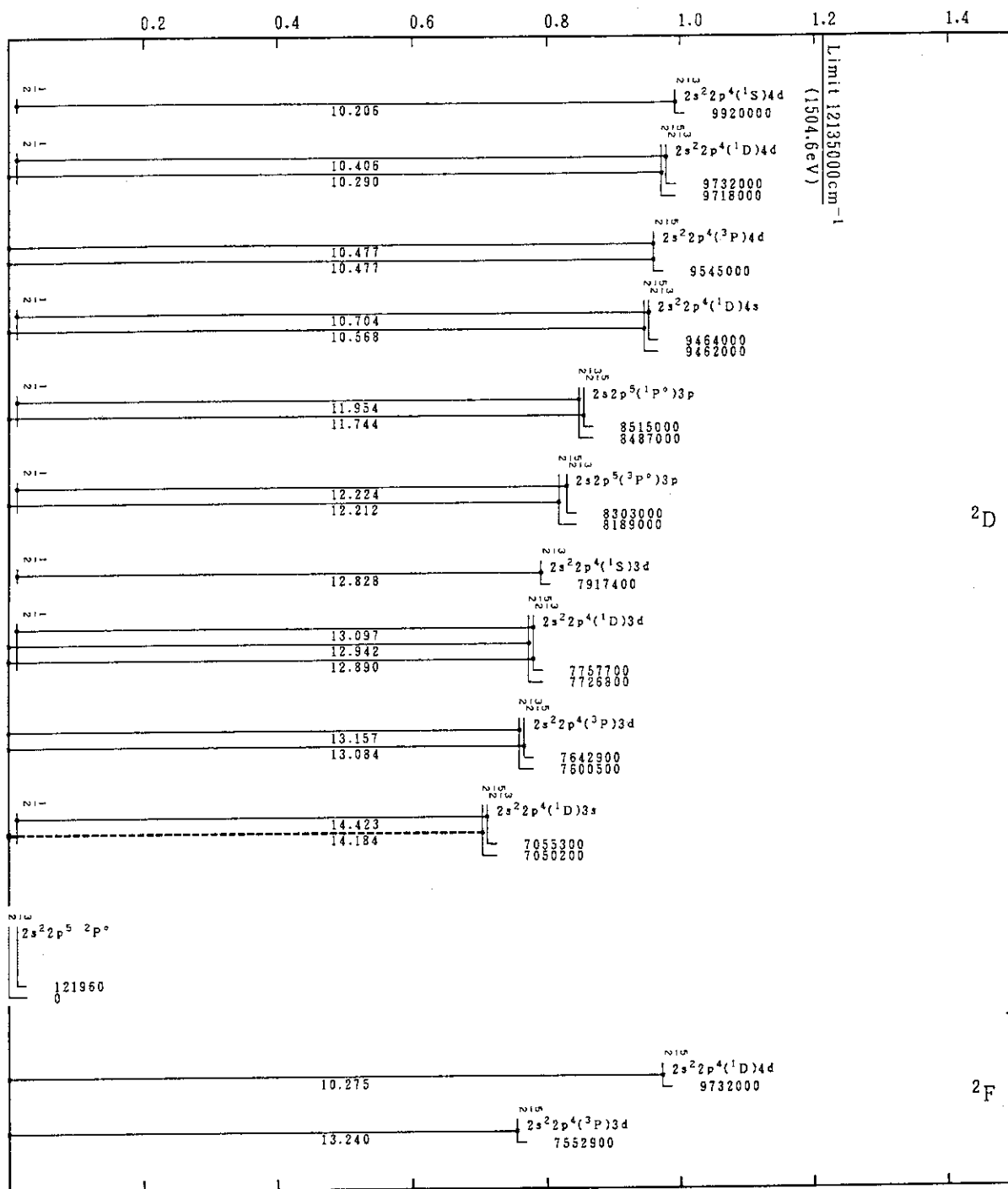

Co XIX (F-Sequence)



Energy (in  $10^7 \text{cm}^{-1}$ )

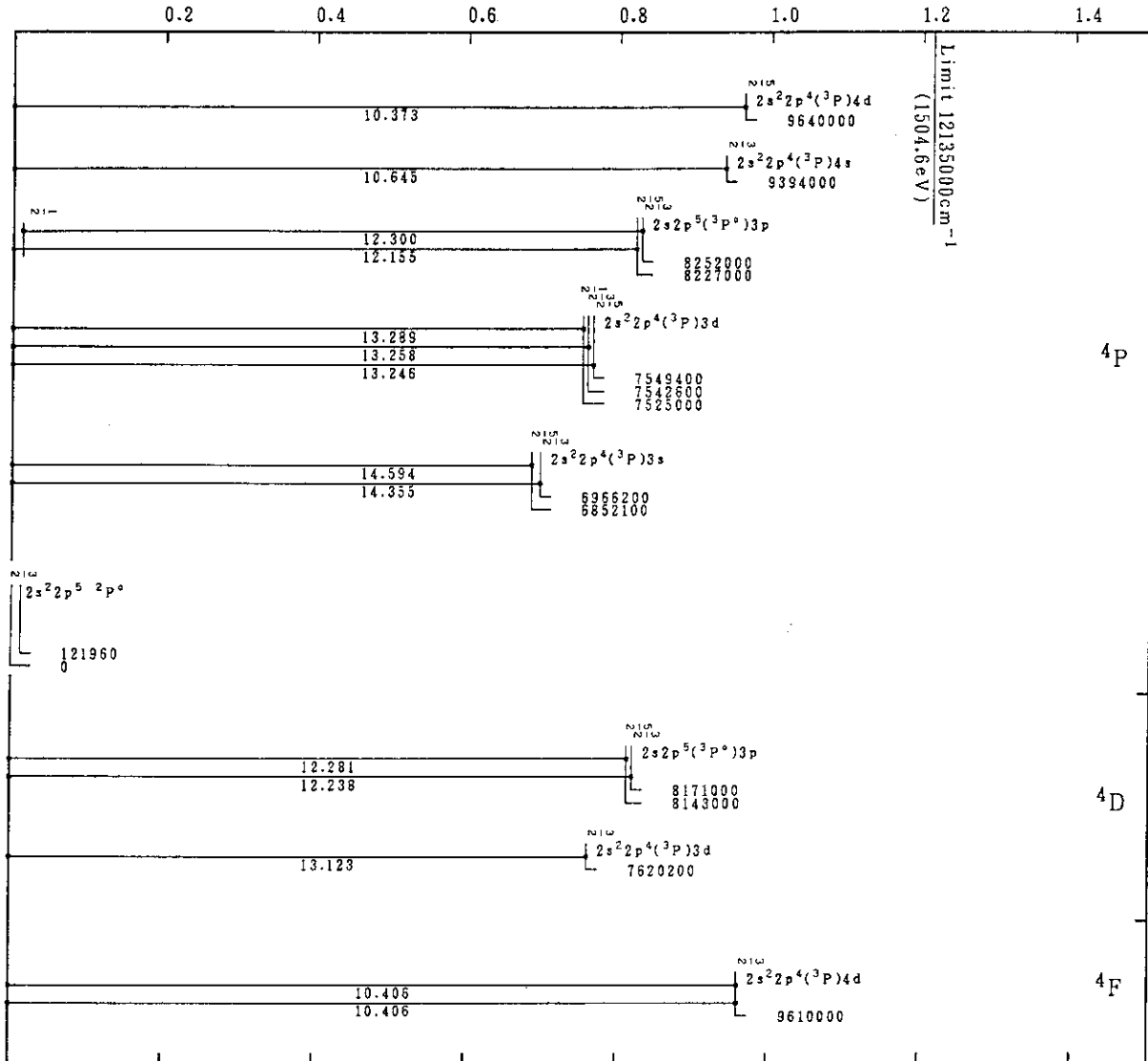

Co XIX (F-Sequence)

Energy (in  $10^7 \text{cm}^{-1}$ )

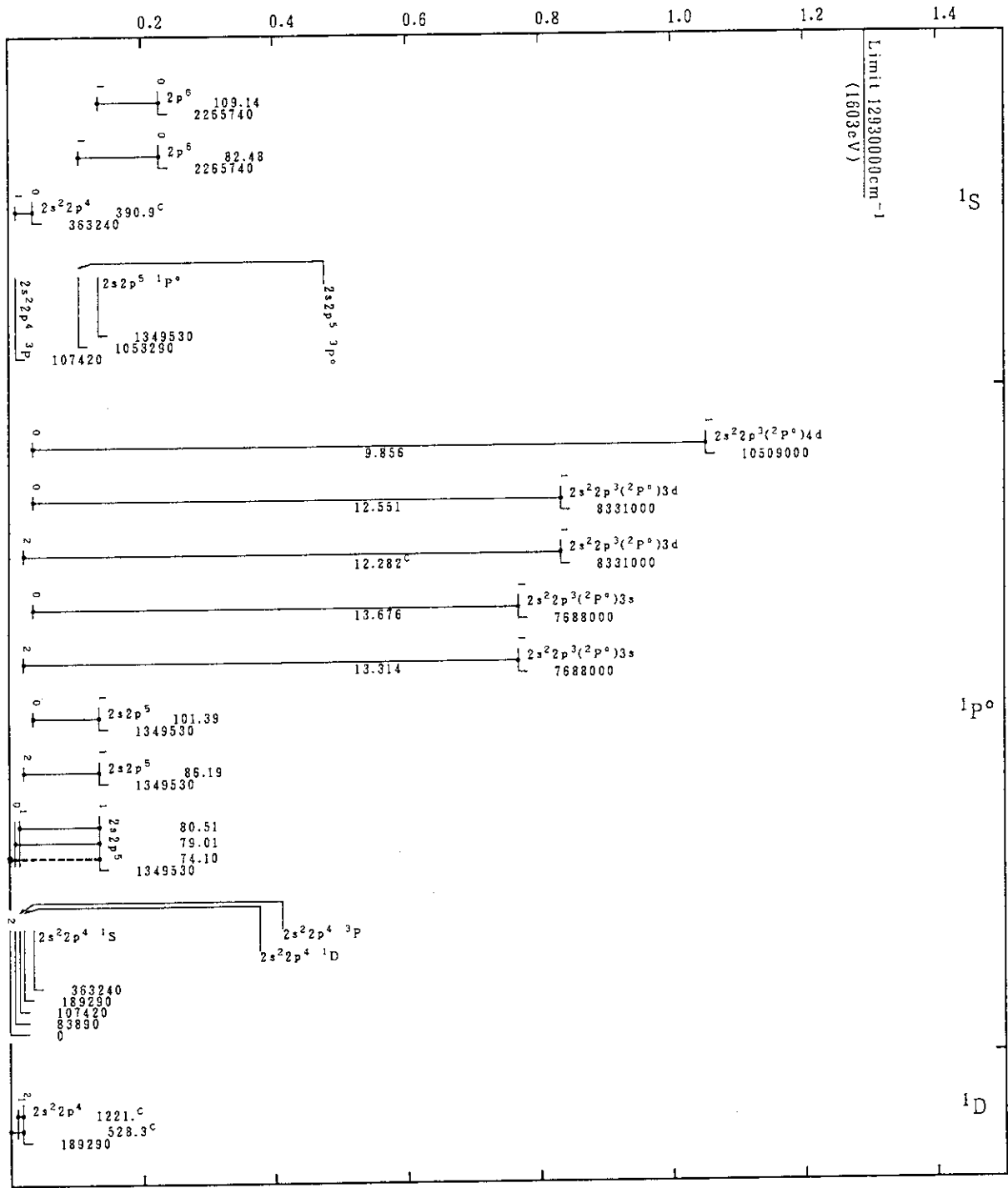

Co XX (O-Sequence)

Energy (in  $10^7 \text{cm}^{-1}$ )

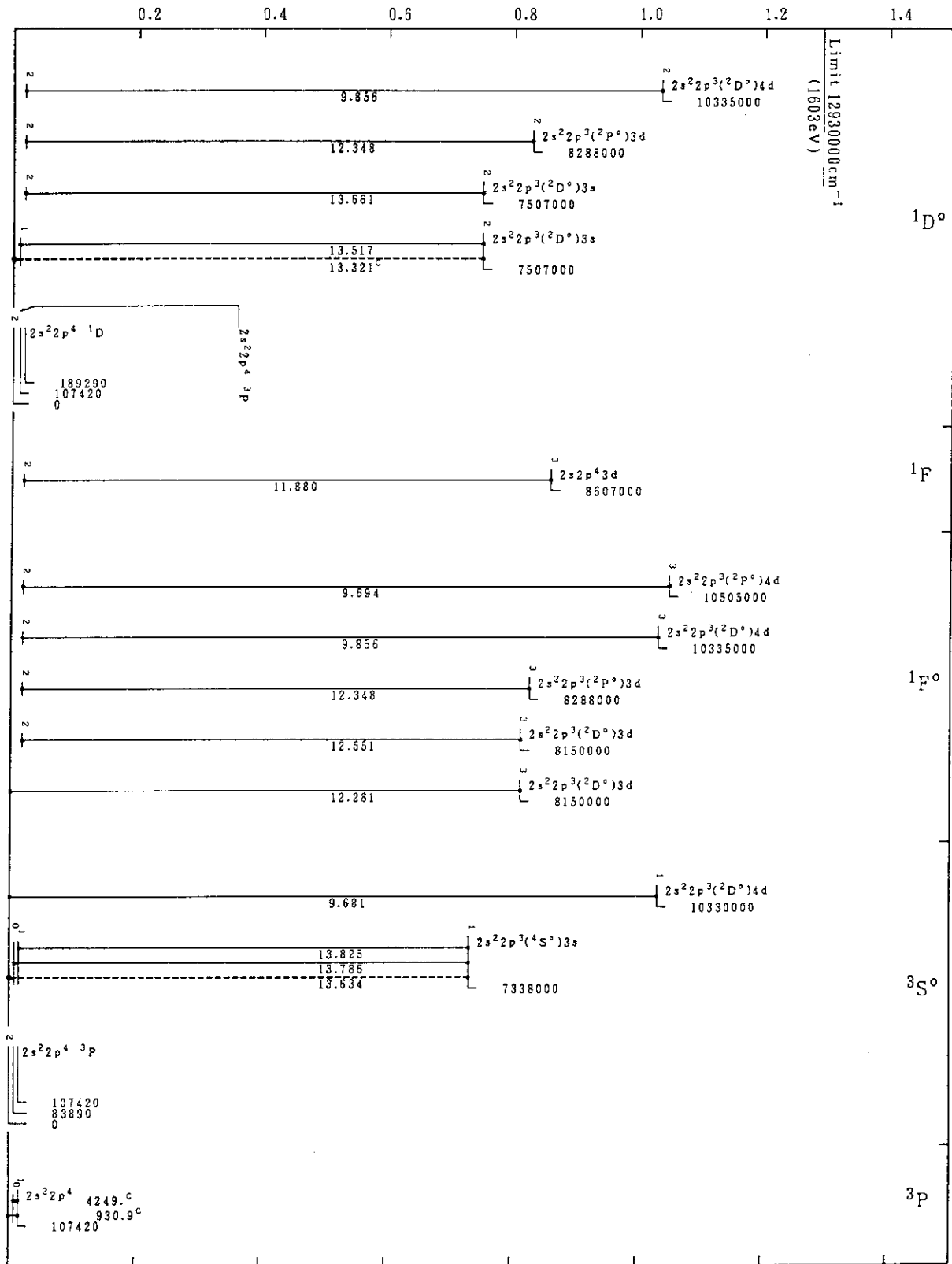

Co XX (O-Sequence)

Energy (in  $10^7 \text{cm}^{-1}$ )

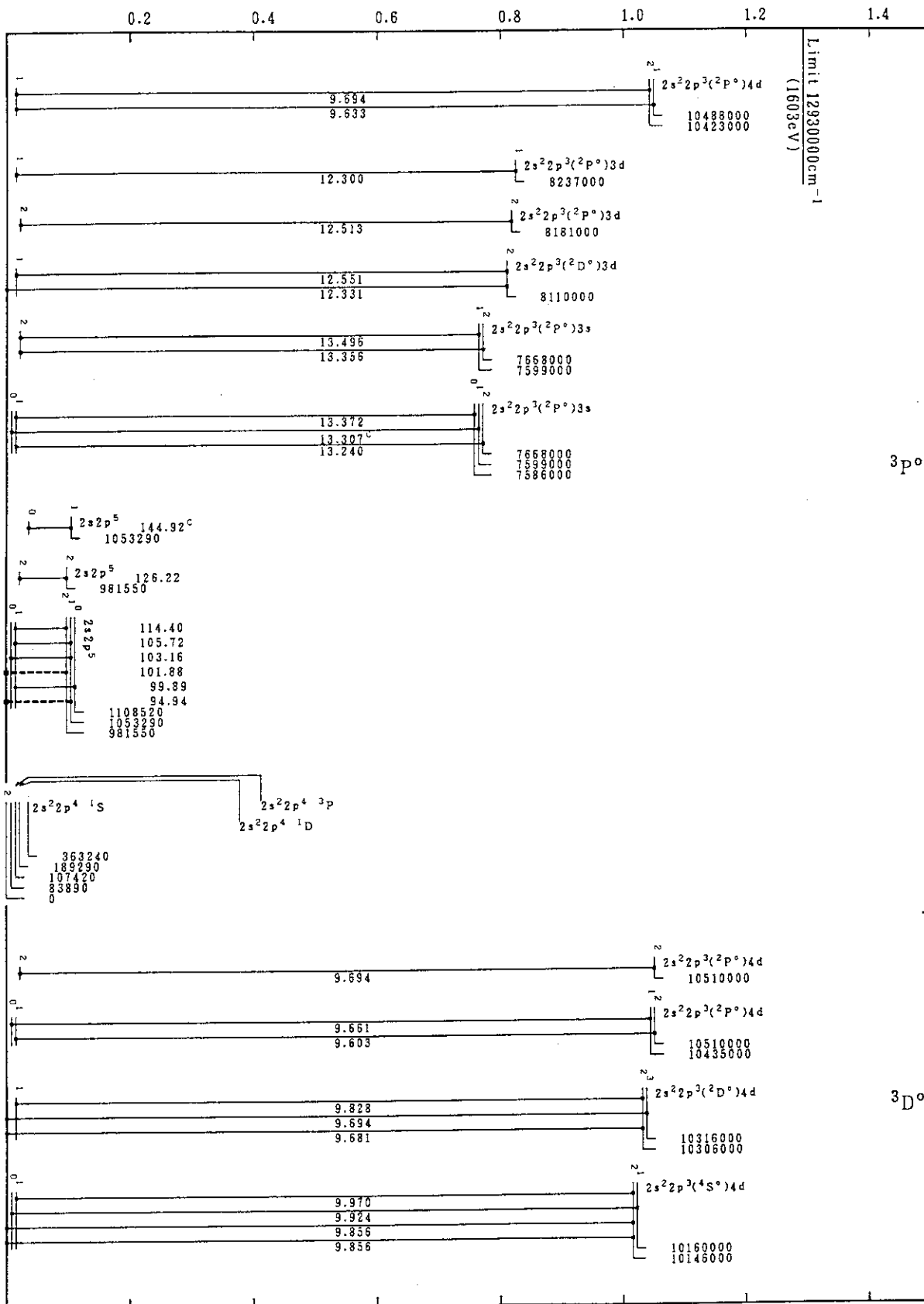

Co XX (O-Sequence)

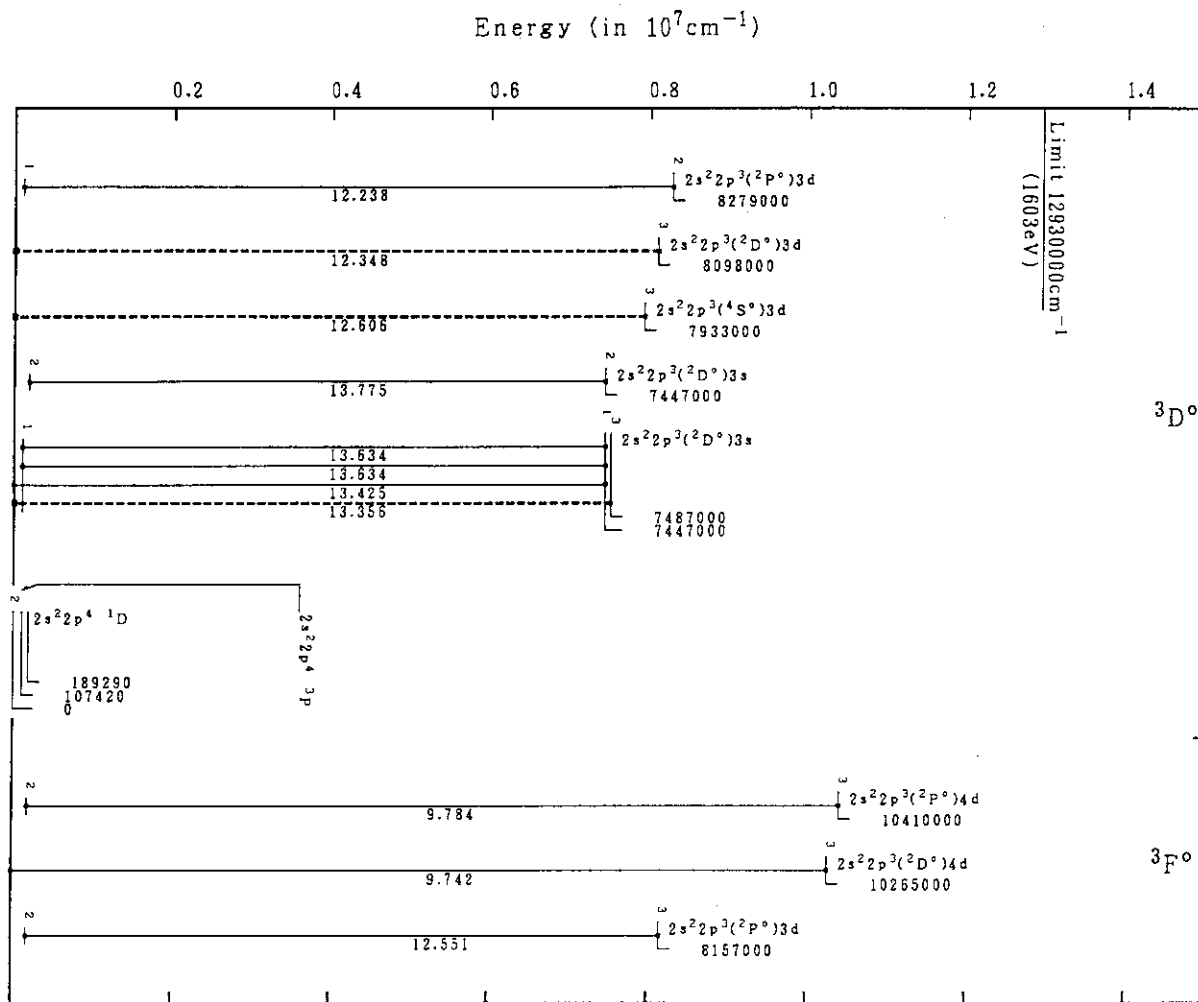

Co XX (O-Sequence)

Energy (in  $10^7 \text{cm}^{-1}$ )

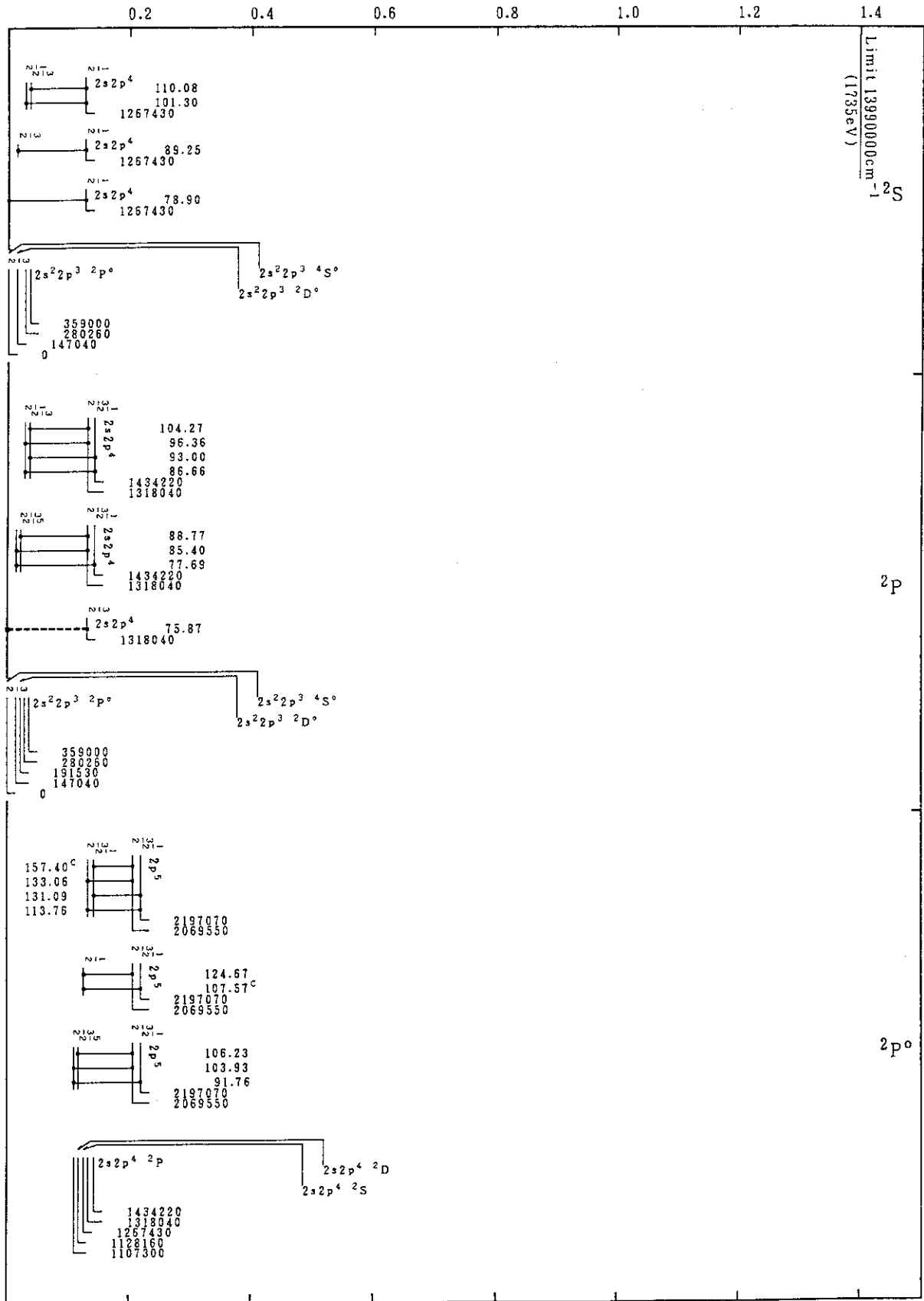

Co XXI (N-Sequence)

Energy (in  $10^7 \text{cm}^{-1}$ )

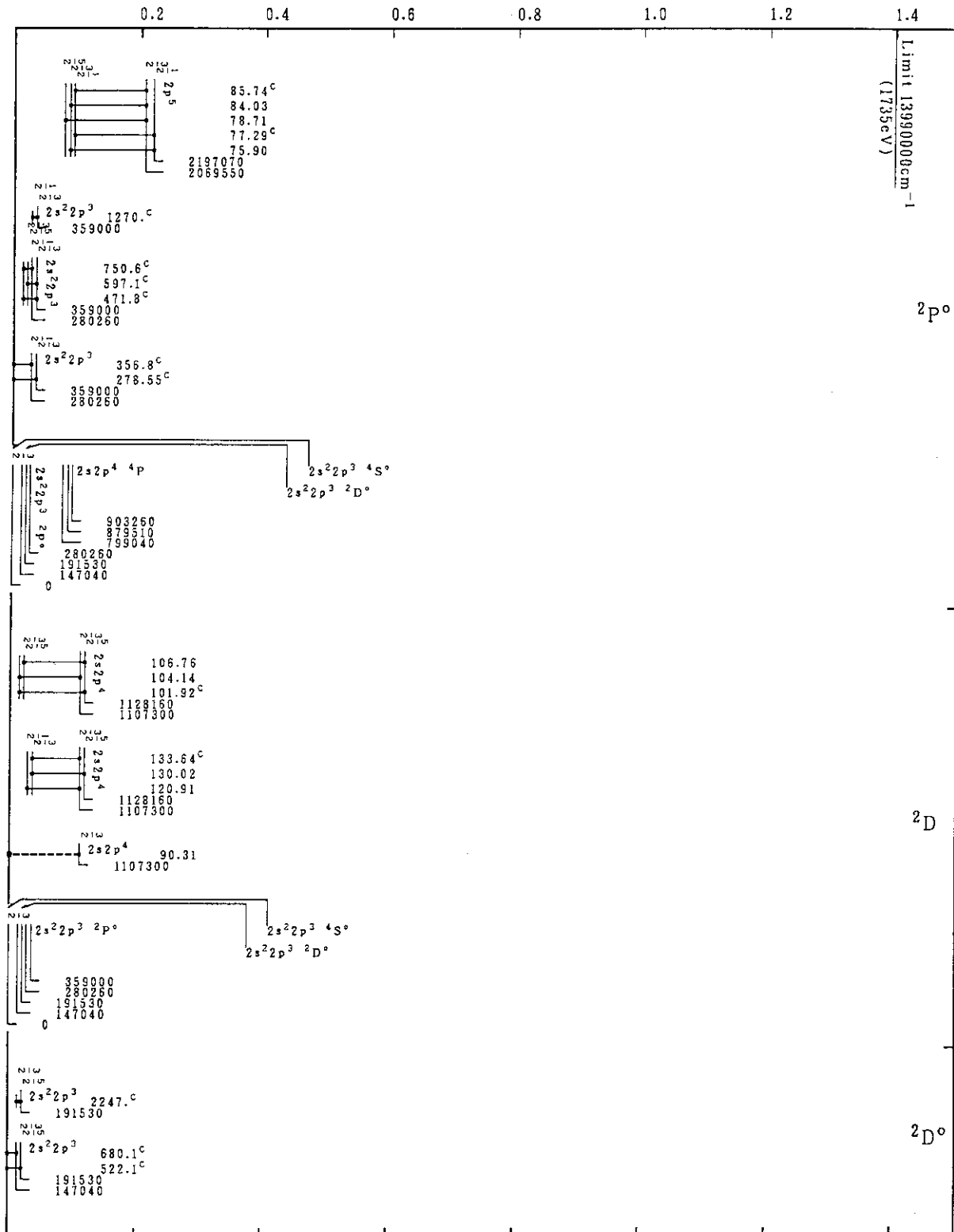

Co XXI (N-Sequence)

Energy (in  $10^7 \text{cm}^{-1}$ )

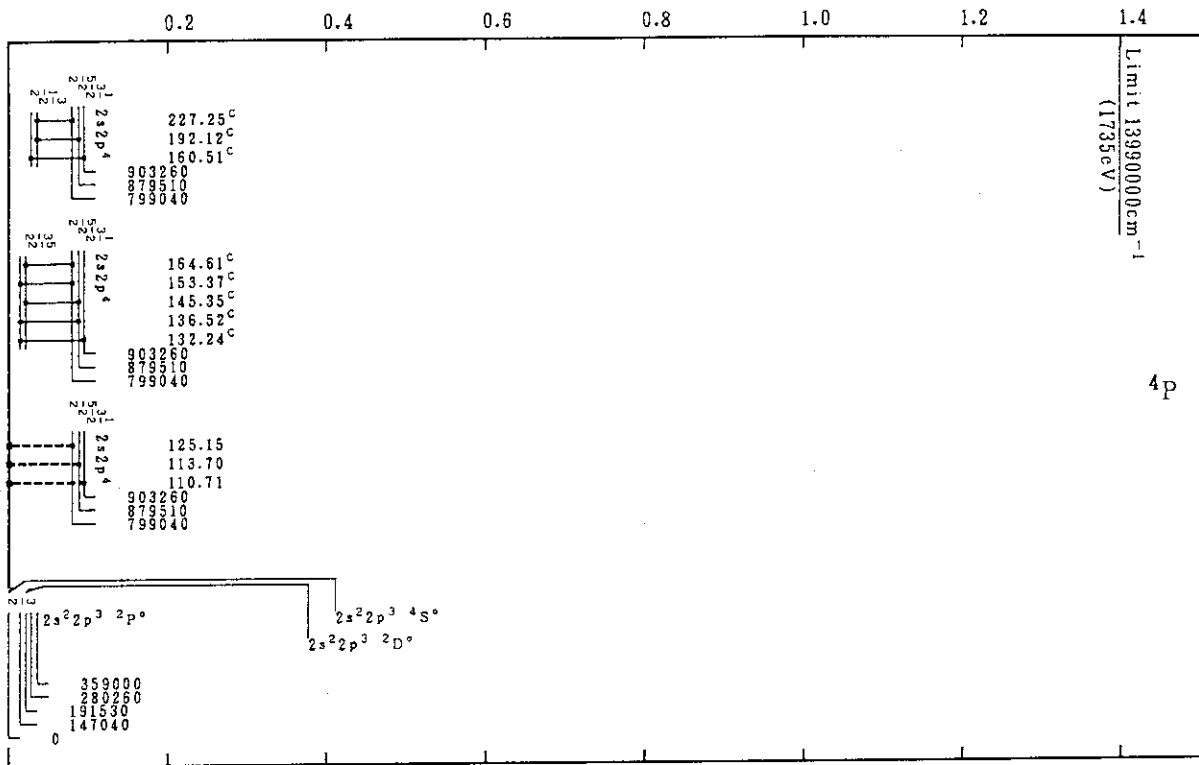

Co XXI (N-Sequence)



Energy (in  $10^7 \text{cm}^{-1}$ )

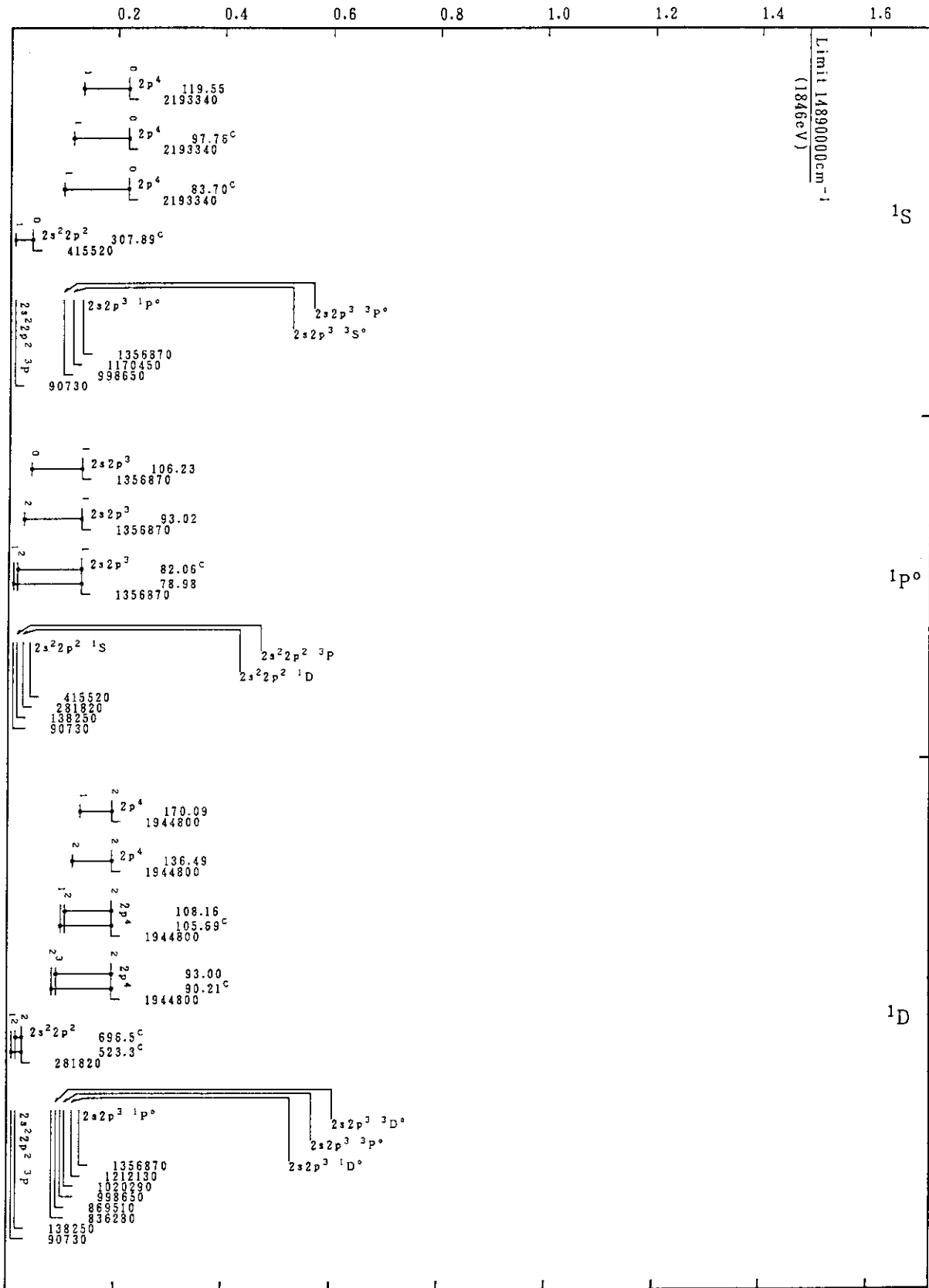

Co XXII (C-Sequence)

Energy (in  $10^7 \text{cm}^{-1}$ )

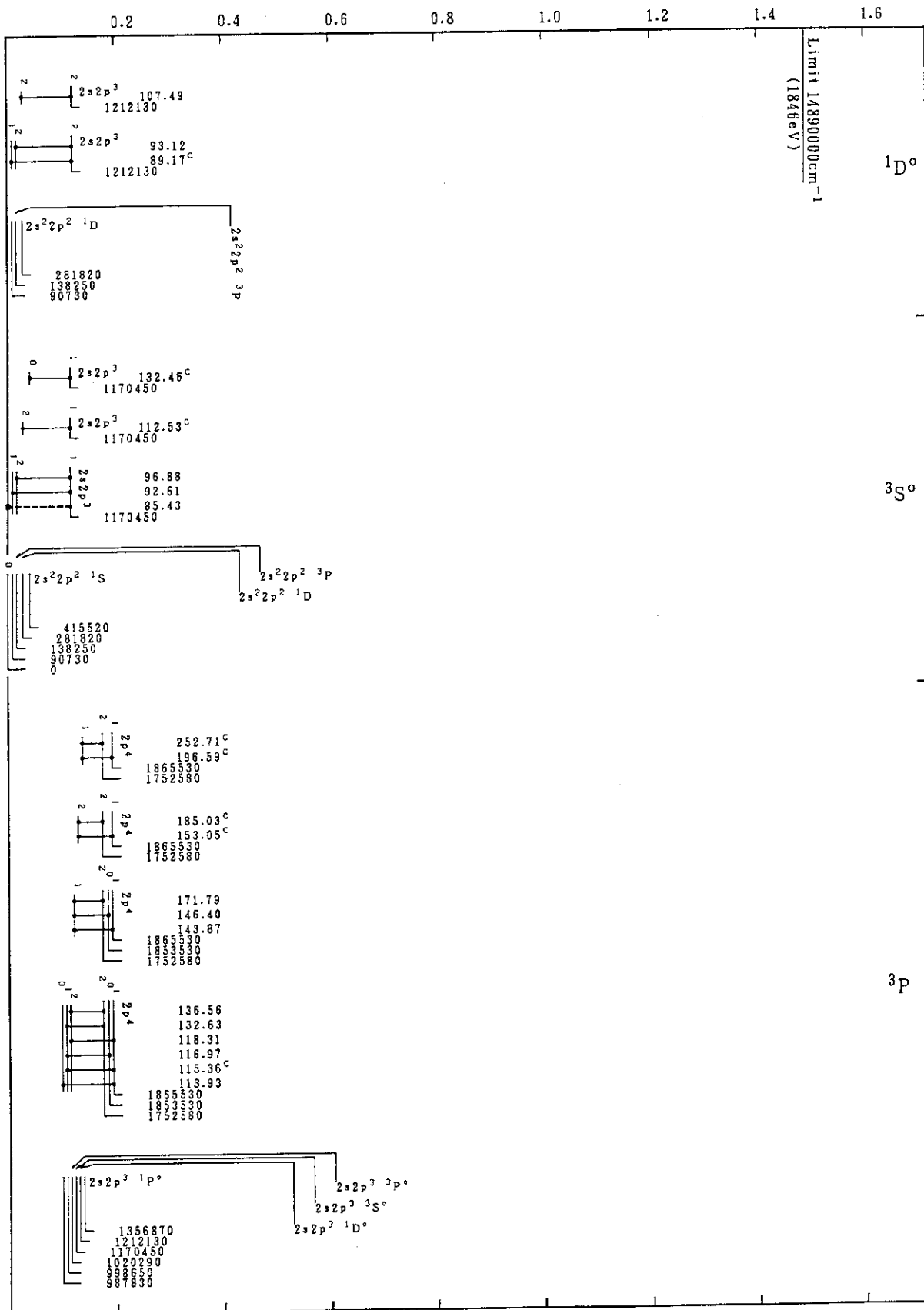

Co XXII (C-Sequence)

Energy (in  $10^7 \text{cm}^{-1}$ )

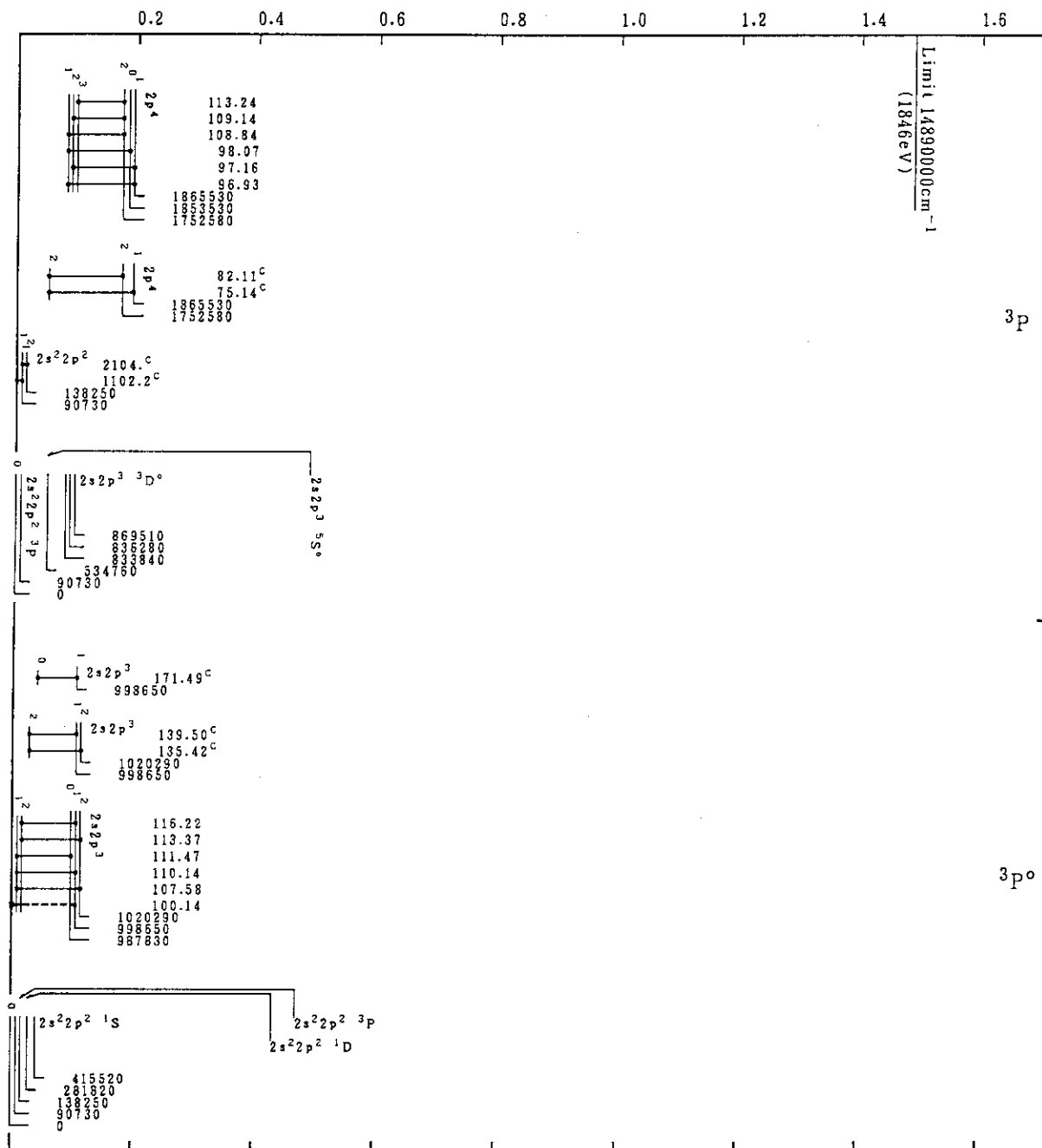

Co XXII (C-Sequence)

Energy (in  $10^7\text{cm}^{-1}$ )

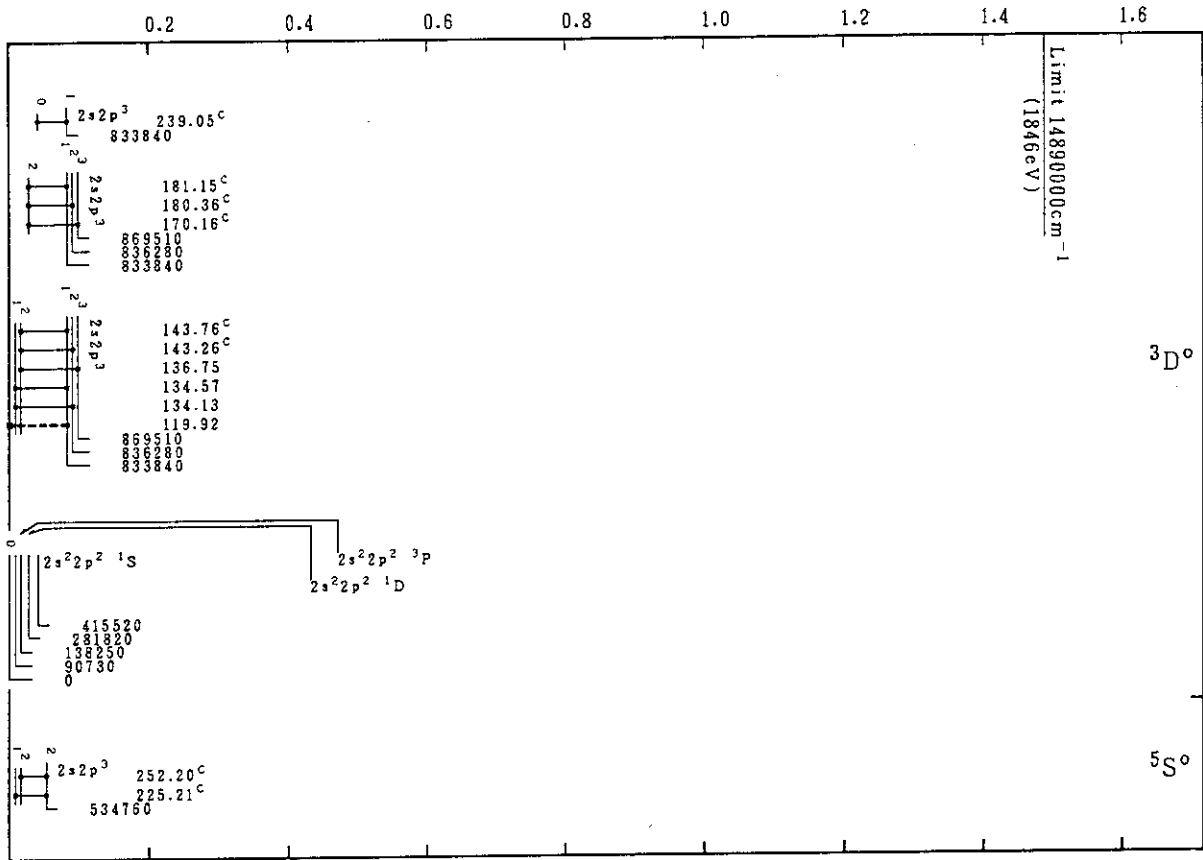

Co XXII (C-Sequence)

Energy (in  $10^7 \text{cm}^{-1}$ )

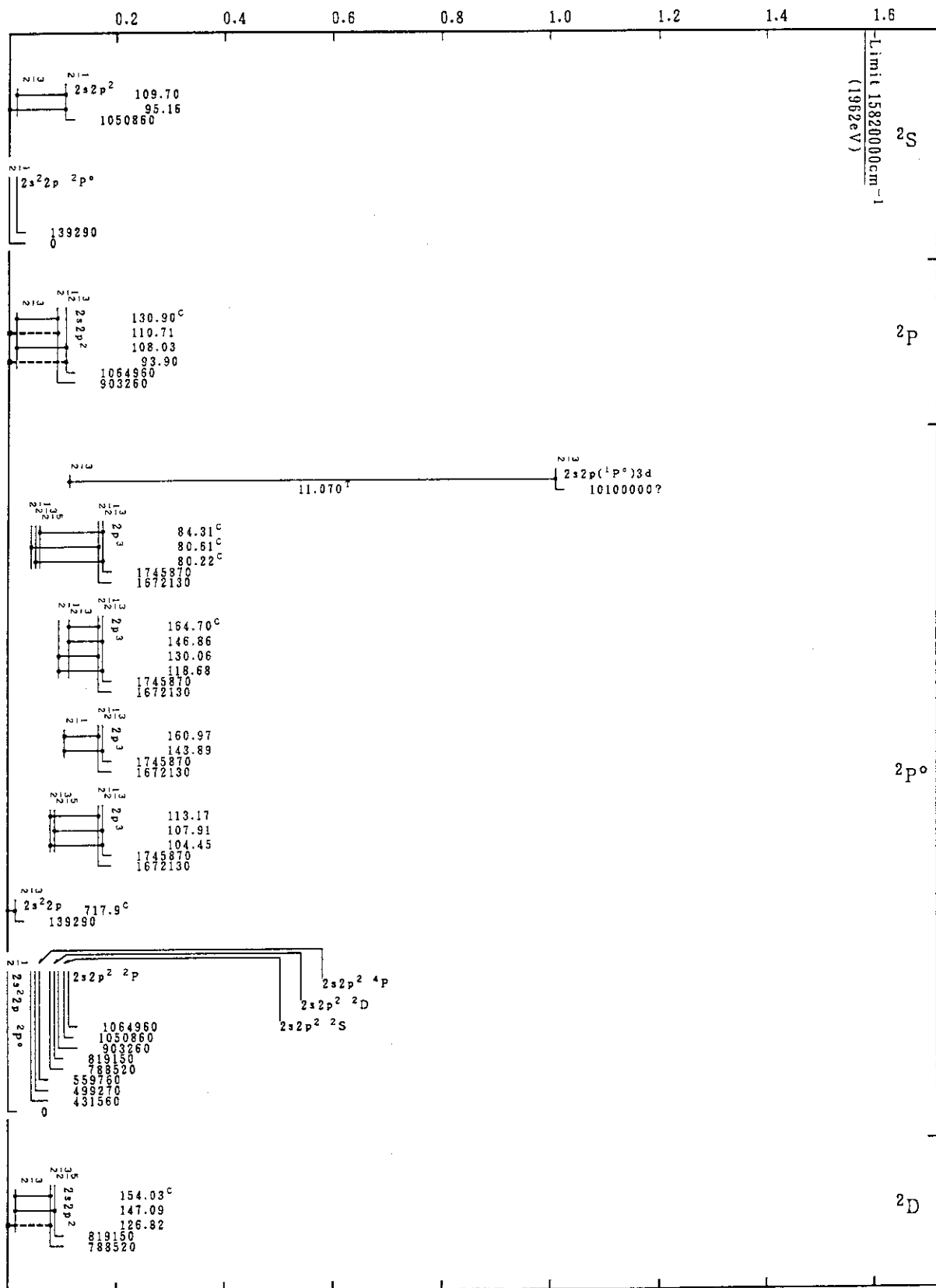

Co XXIII (B-Sequence)

Energy (in  $10^7 \text{cm}^{-1}$ )

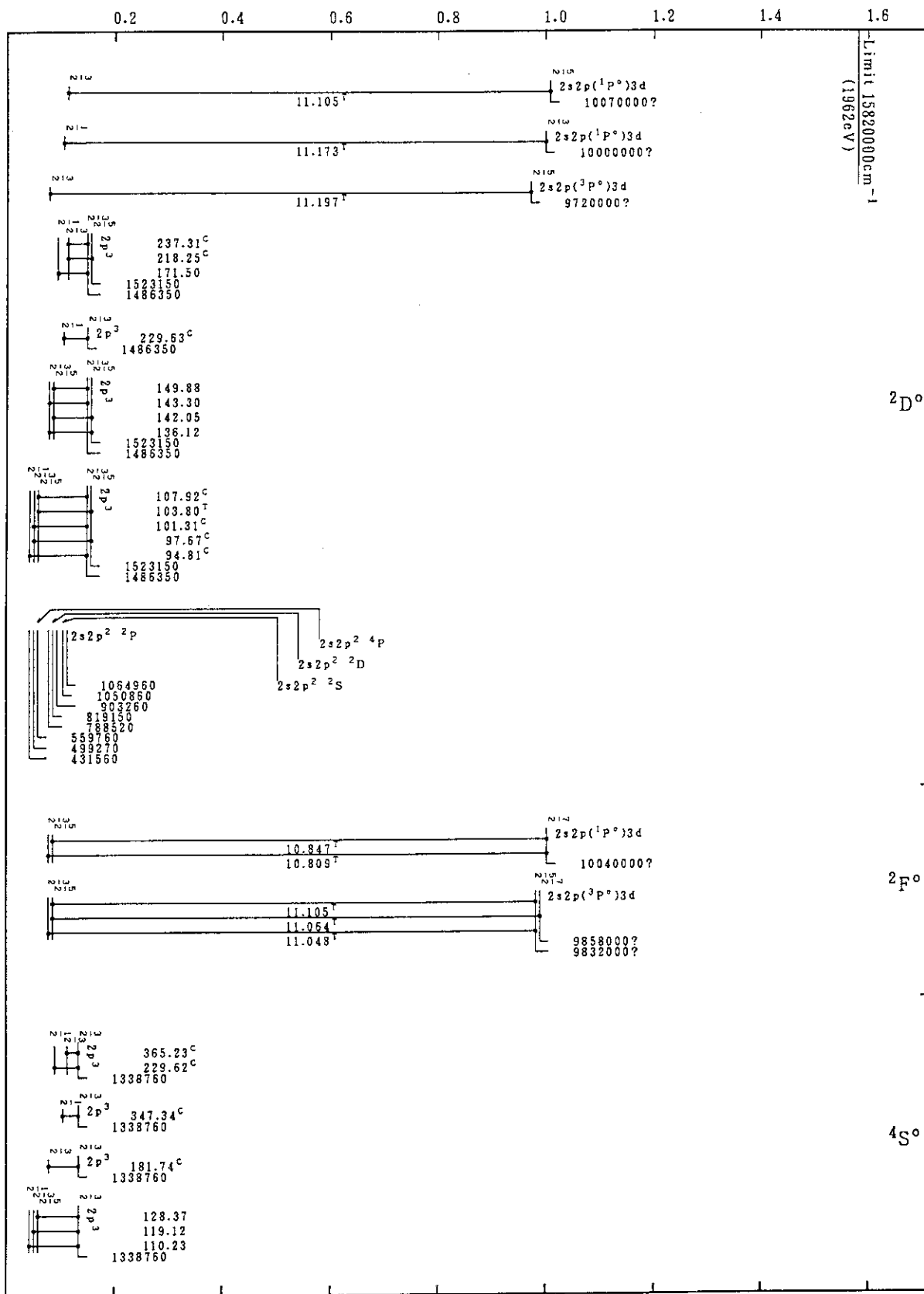

Co XXIII (B-Sequence)

Energy (in  $10^7 \text{cm}^{-1}$ )

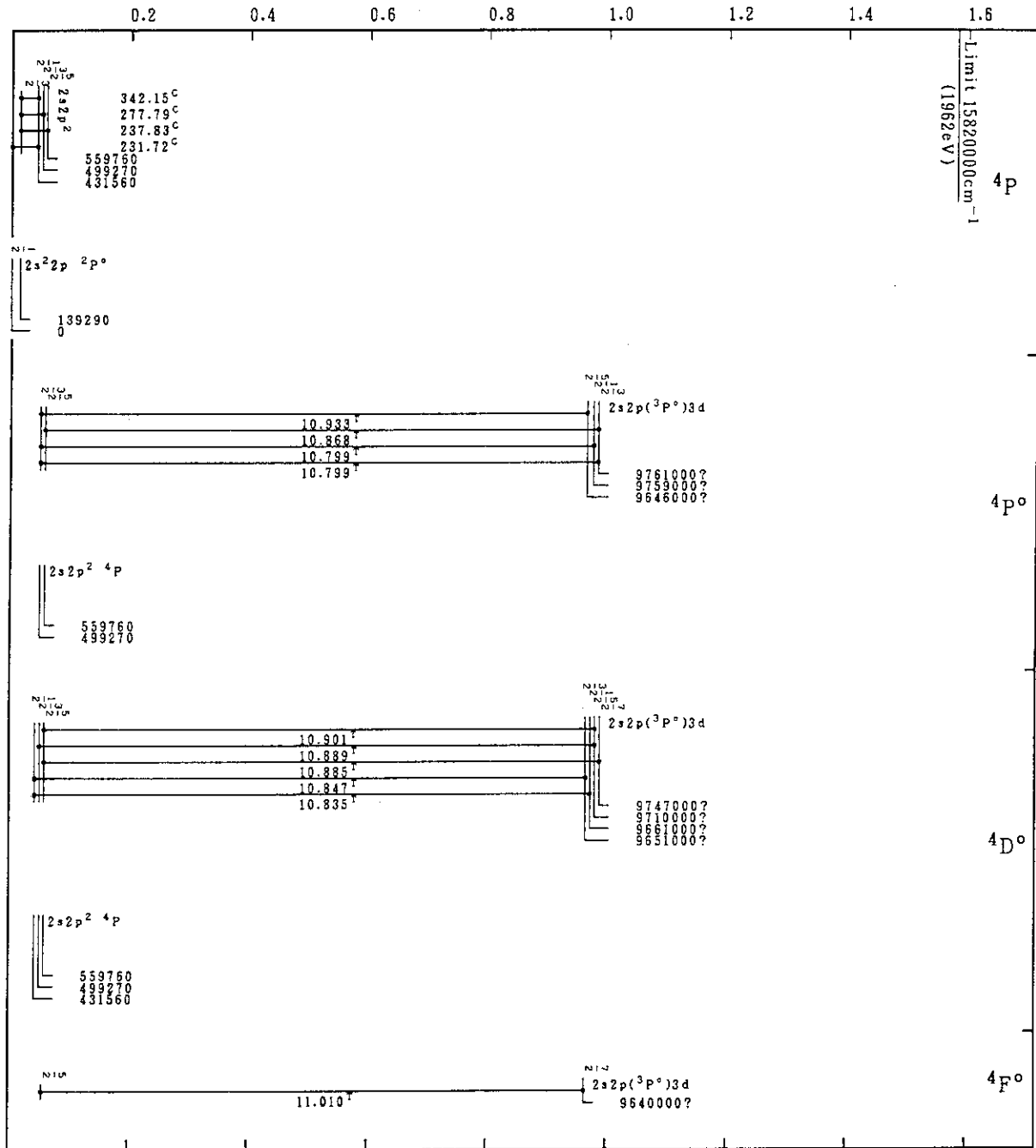

Co XXIII (B-Sequence)

Energy (in  $10^7 \text{cm}^{-1}$ )

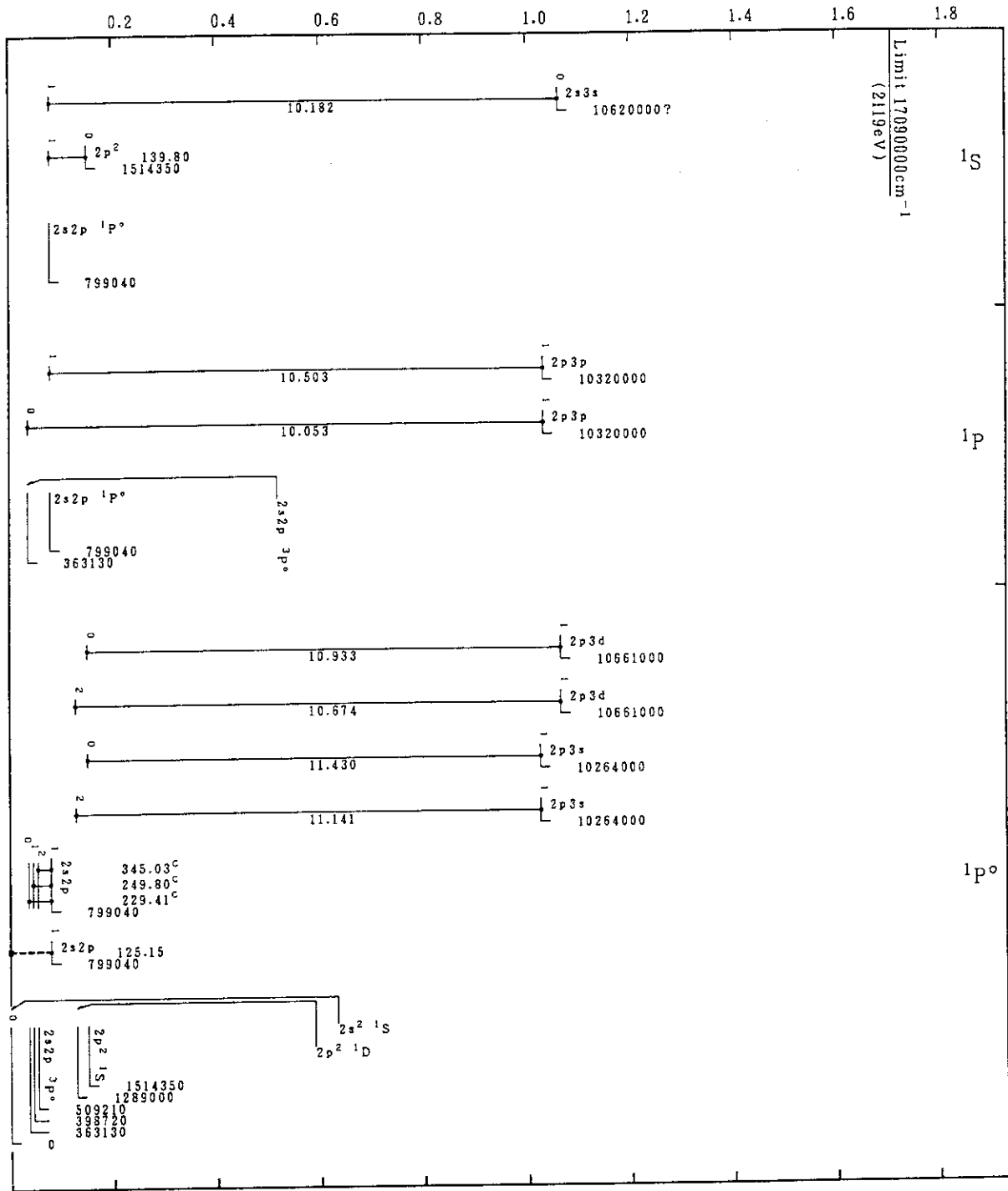

Co XXIV (Be-Sequence)



Energy (in  $10^7 \text{cm}^{-1}$ )

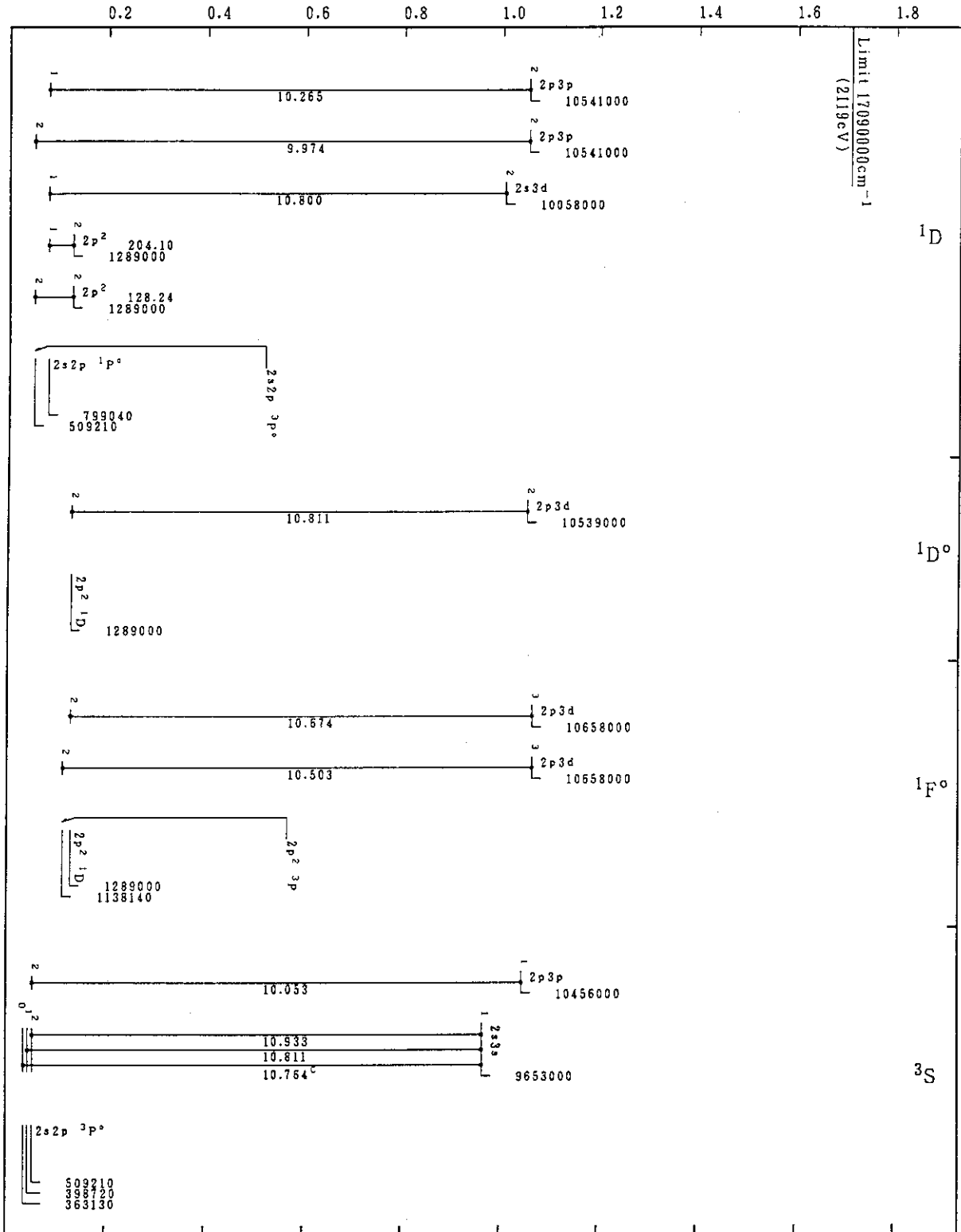

Co XXIV (Be-Sequence)

Energy (in  $10^7 \text{cm}^{-1}$ )

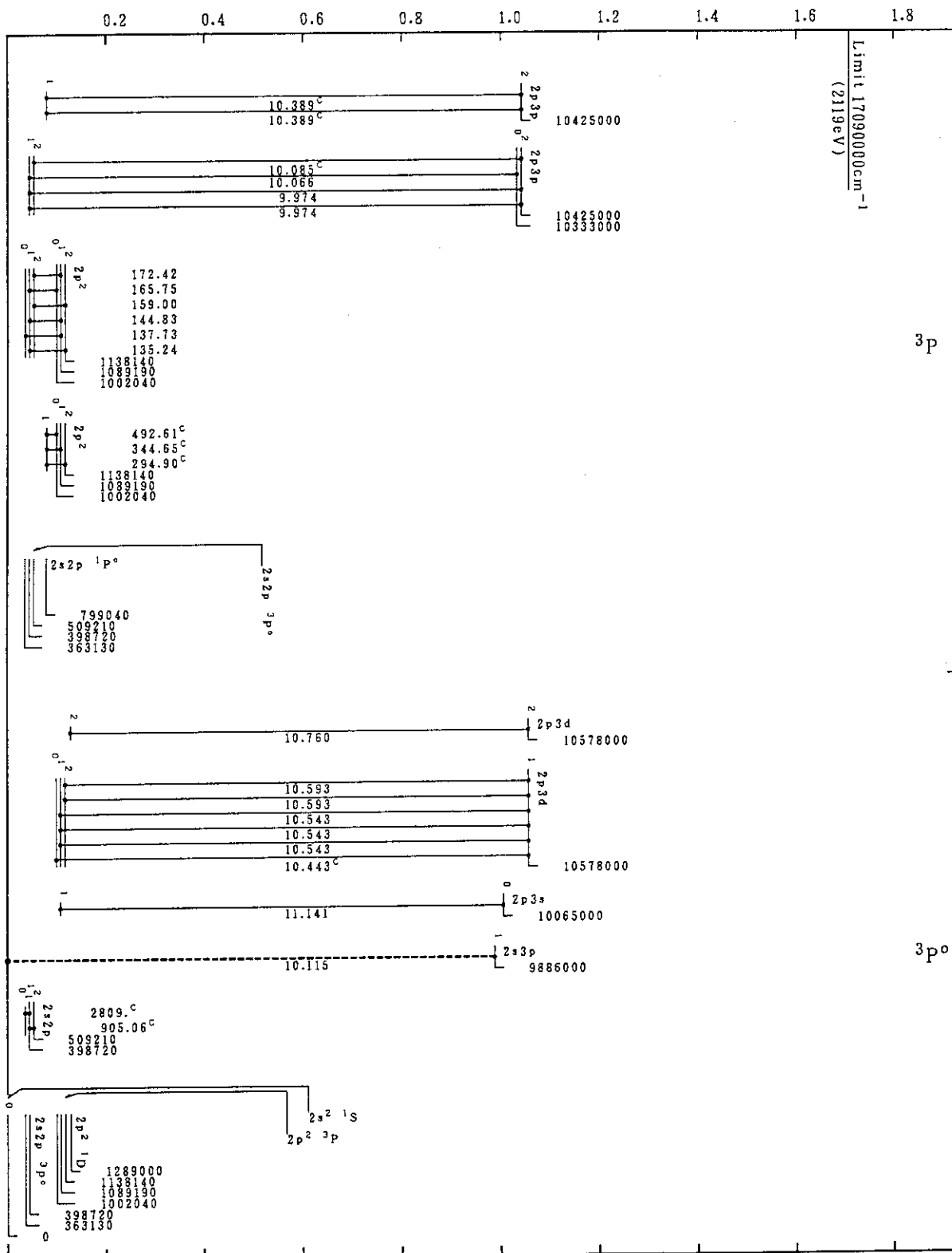

Co XXIV (Be-Sequence)

Energy (in  $10^7 \text{cm}^{-1}$ )

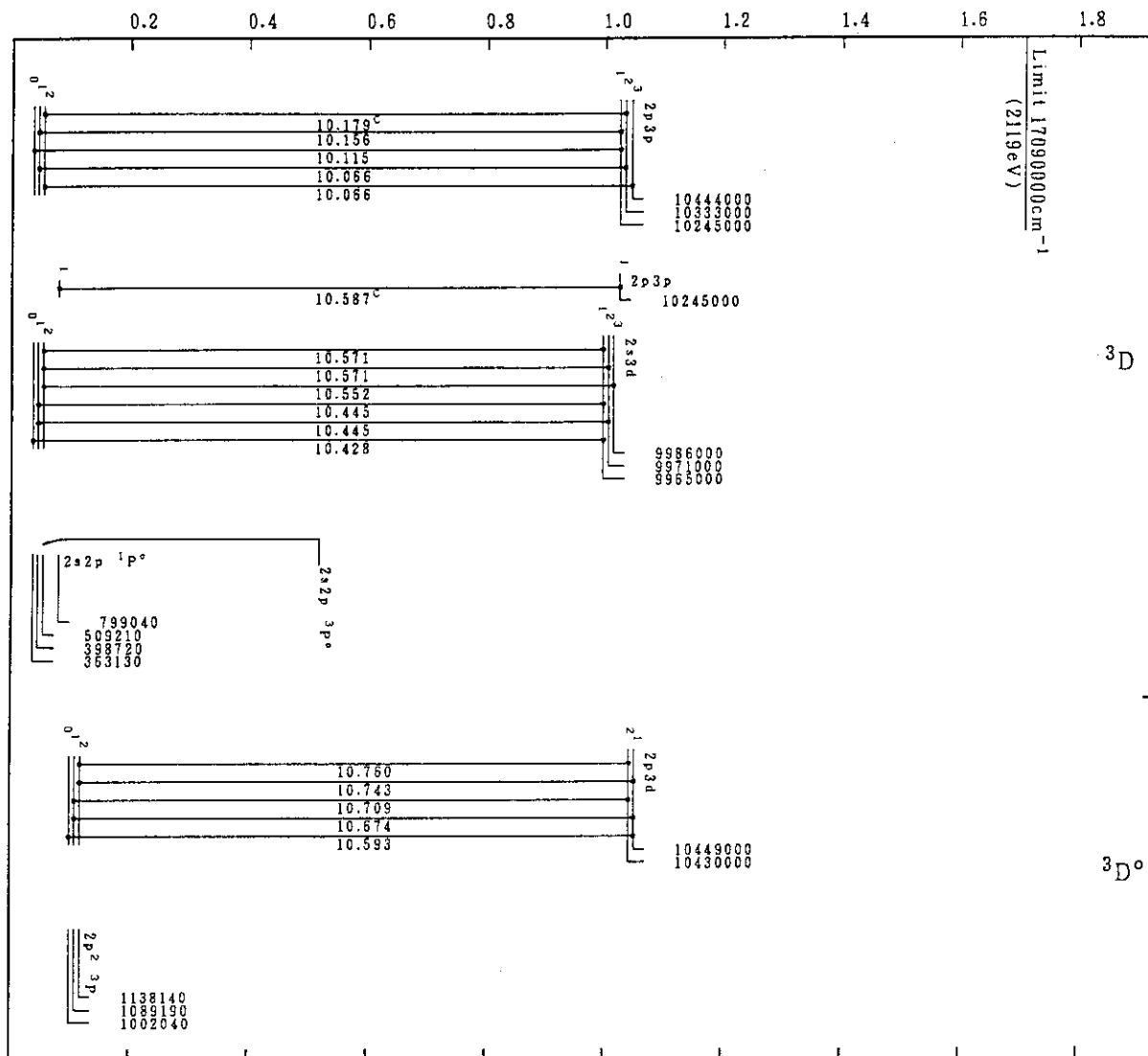

Co XXIV (Be-Sequence)

Energy (in  $10^7 \text{cm}^{-1}$ )

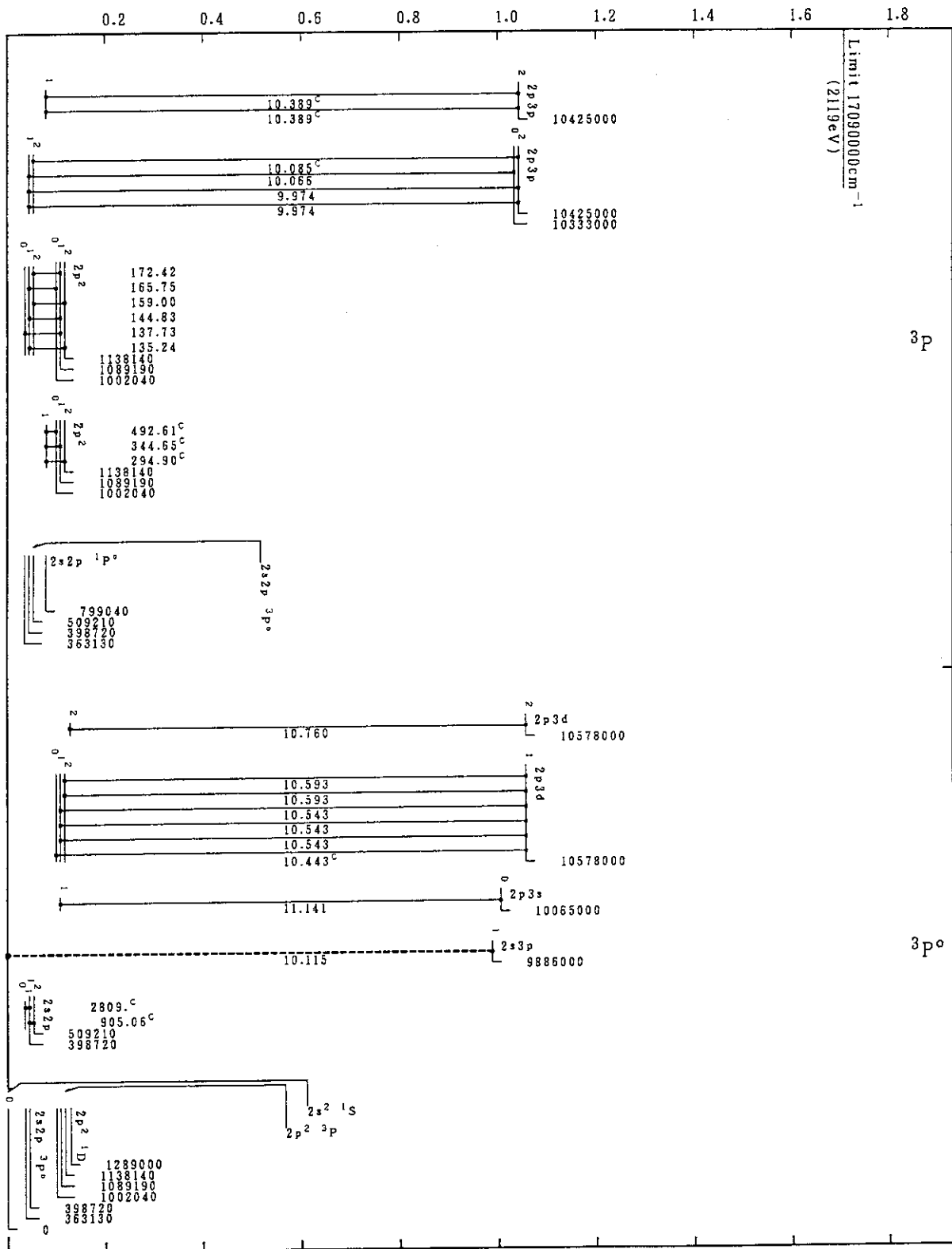

Co XXIV (Be-Sequence)

Energy (in  $10^7 \text{cm}^{-1}$ )

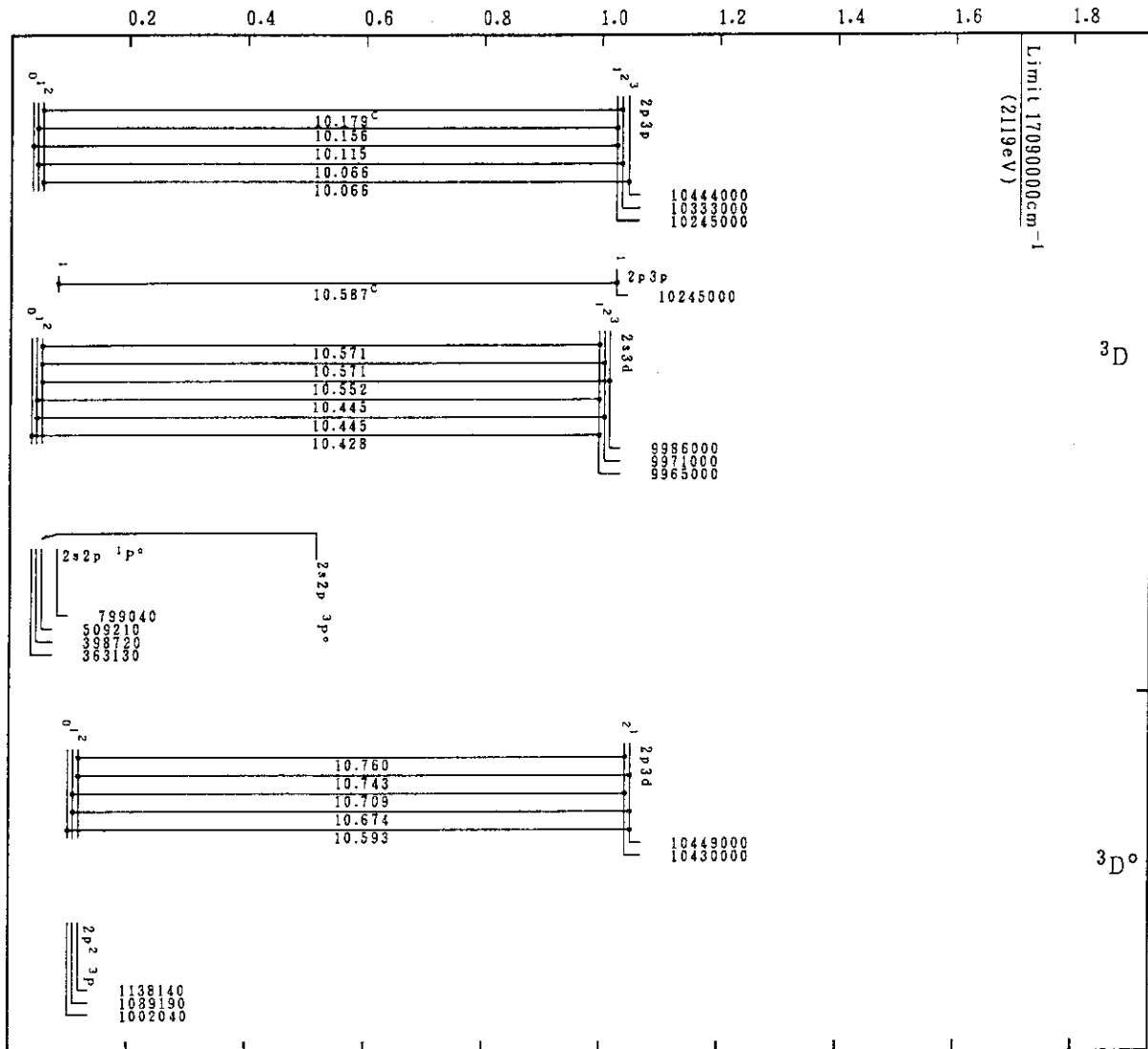

Co XXIV (Be-Sequence)

Energy (in  $10^7 \text{cm}^{-1}$ )

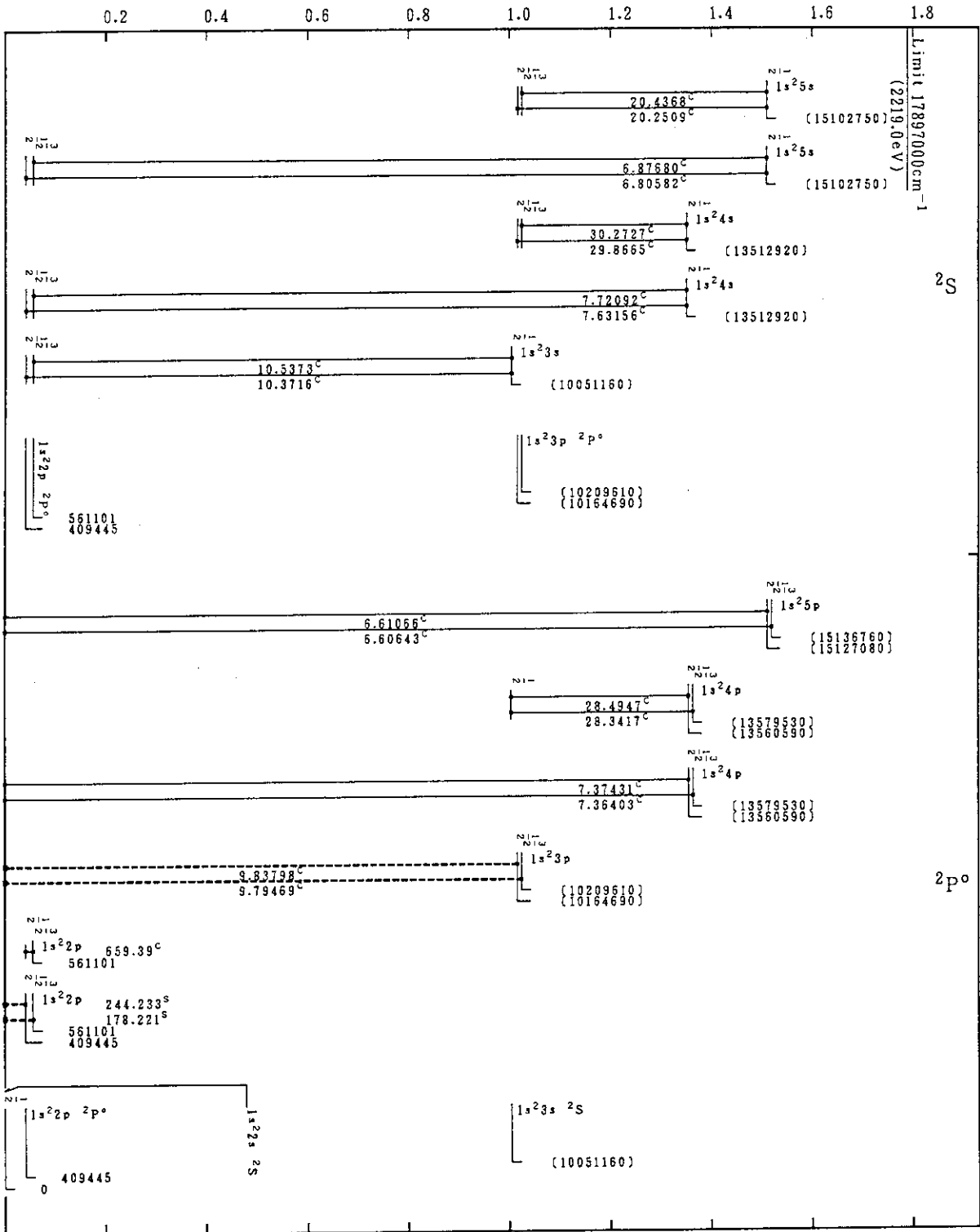

Co XXV (Li-Sequence)

Energy (in  $10^7 \text{cm}^{-1}$ )

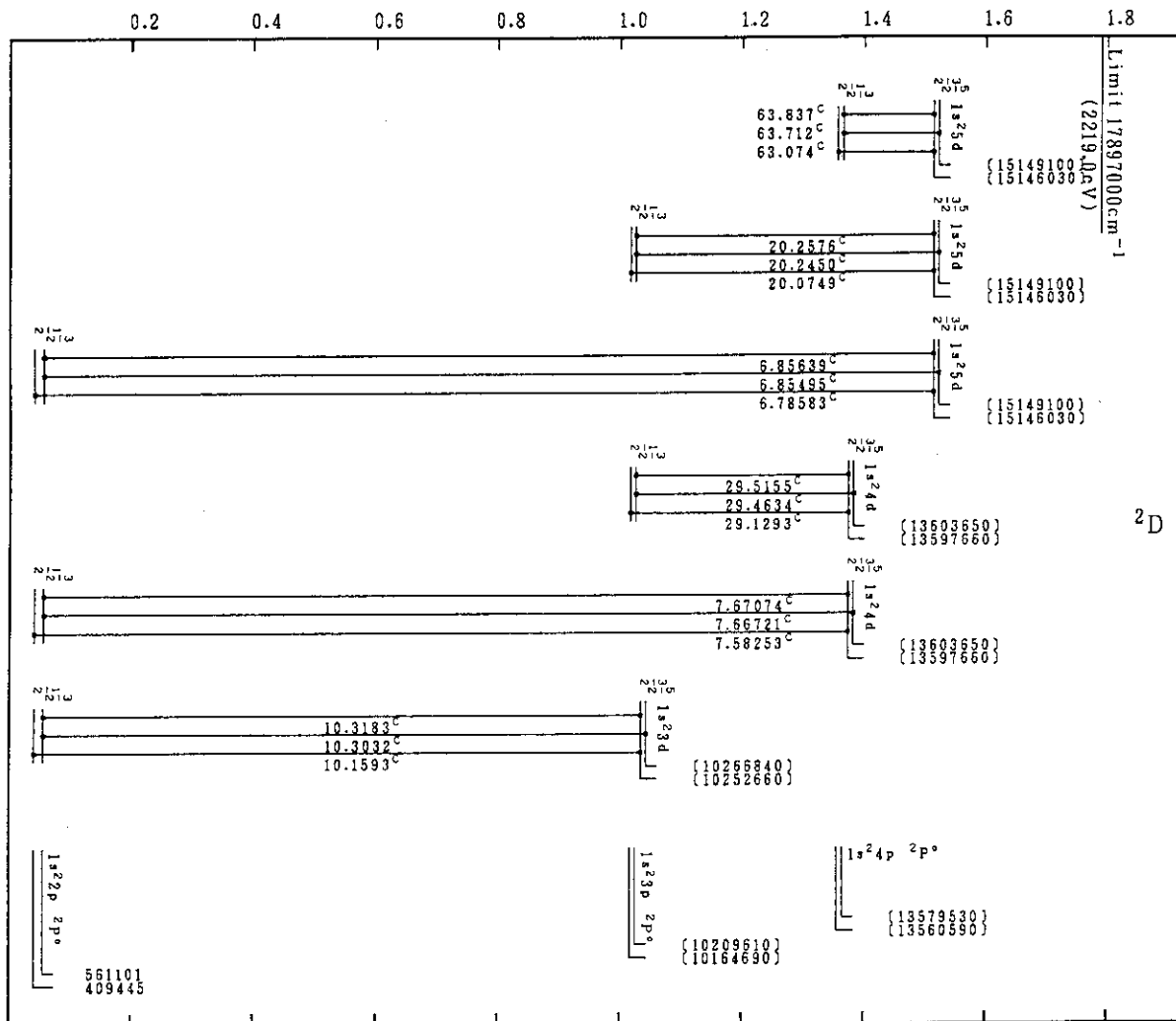

Co XXV (Li-Sequence)

Energy (in  $10^7 \text{cm}^{-1}$ )

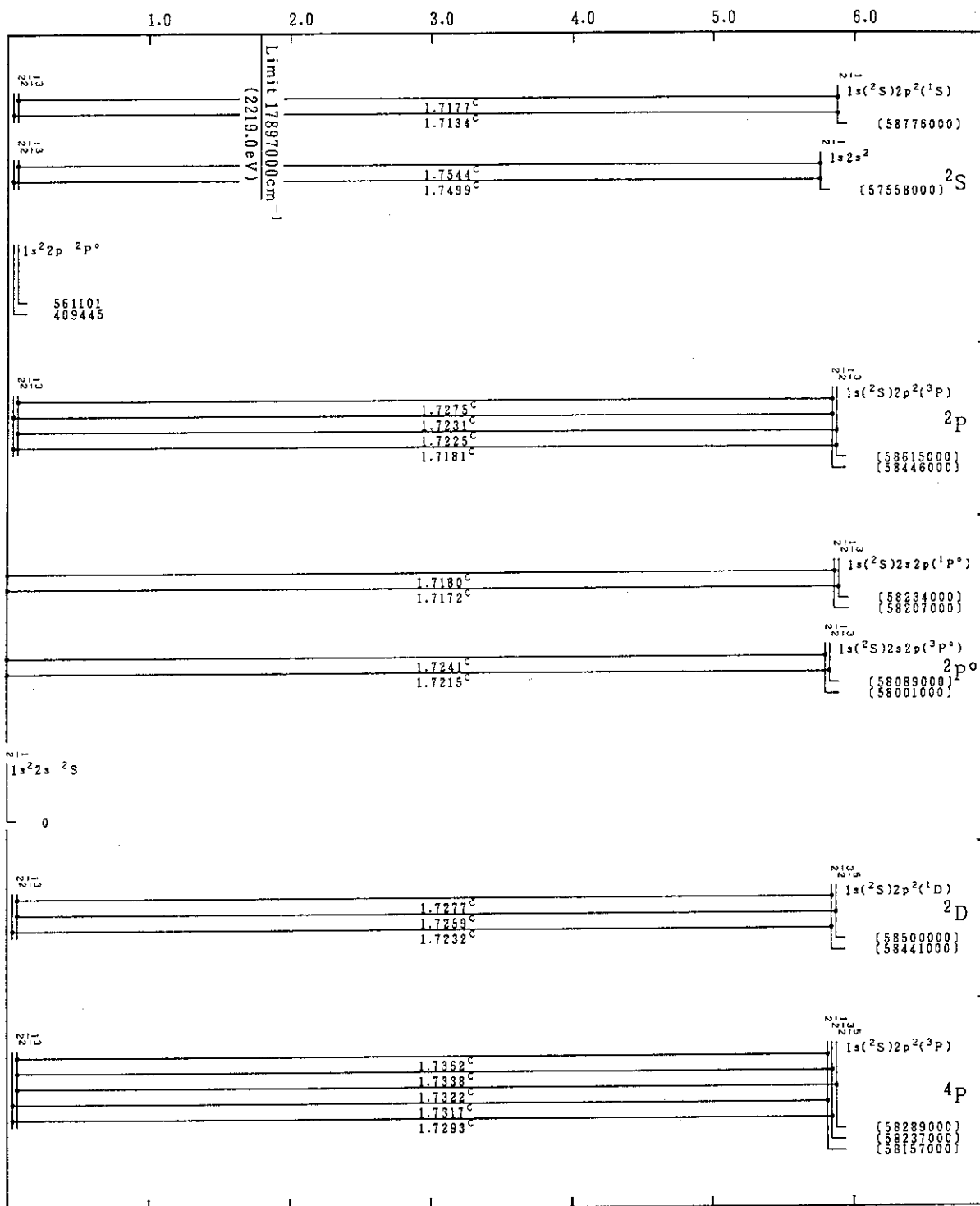

Co XXV (Li-Sequence)



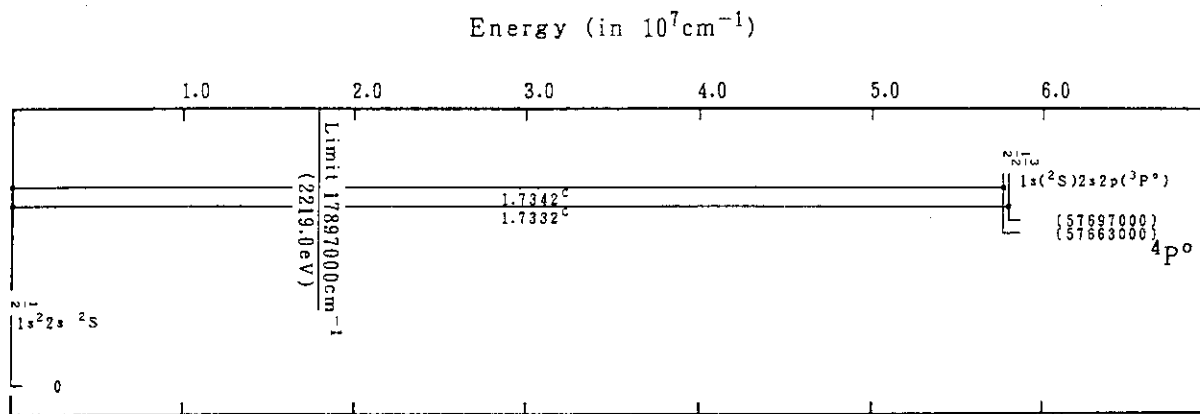



Energy (in  $10^7 \text{cm}^{-1}$ )

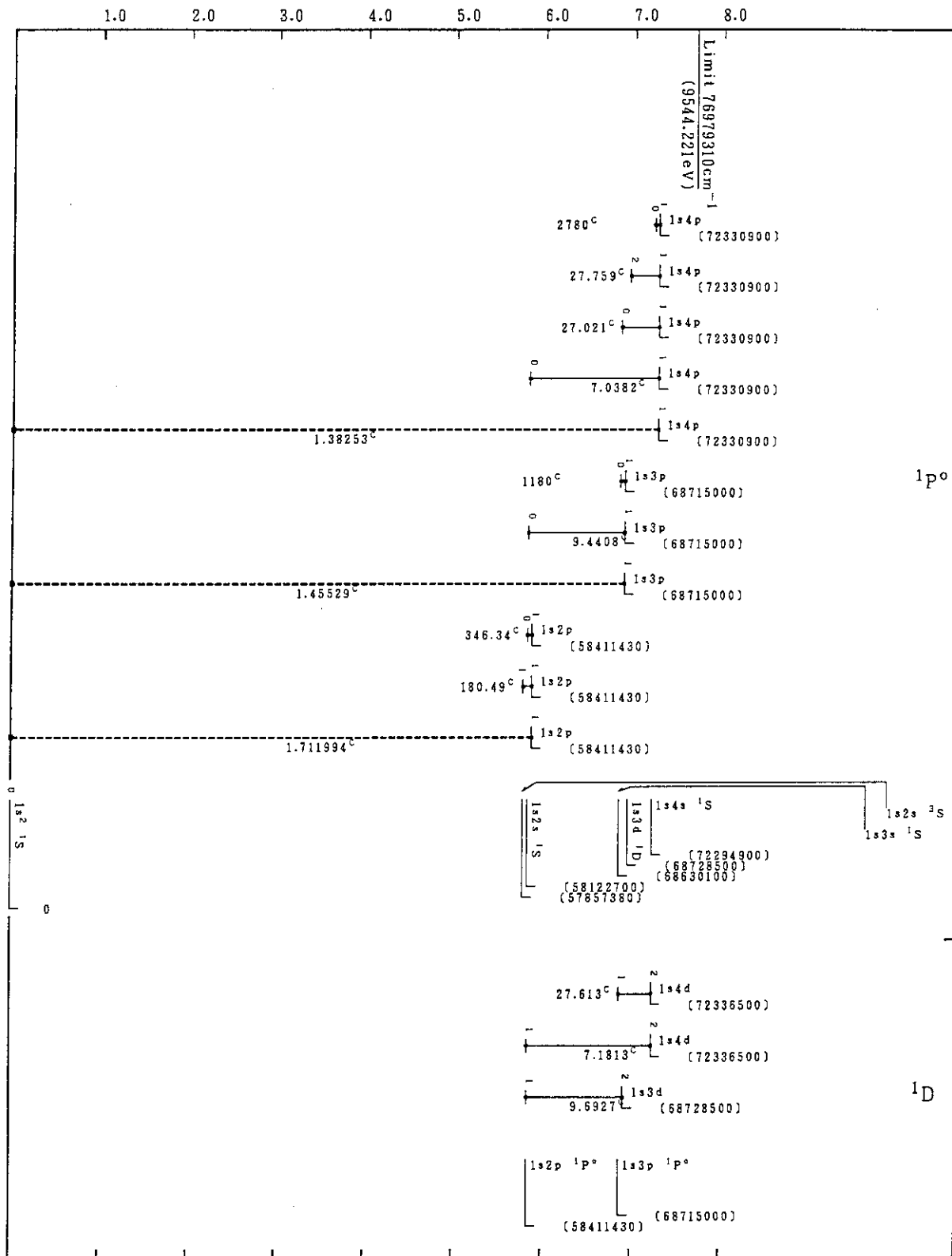

Co XXVI (He-Sequence)



Energy (in  $10^7 \text{cm}^{-1}$ )

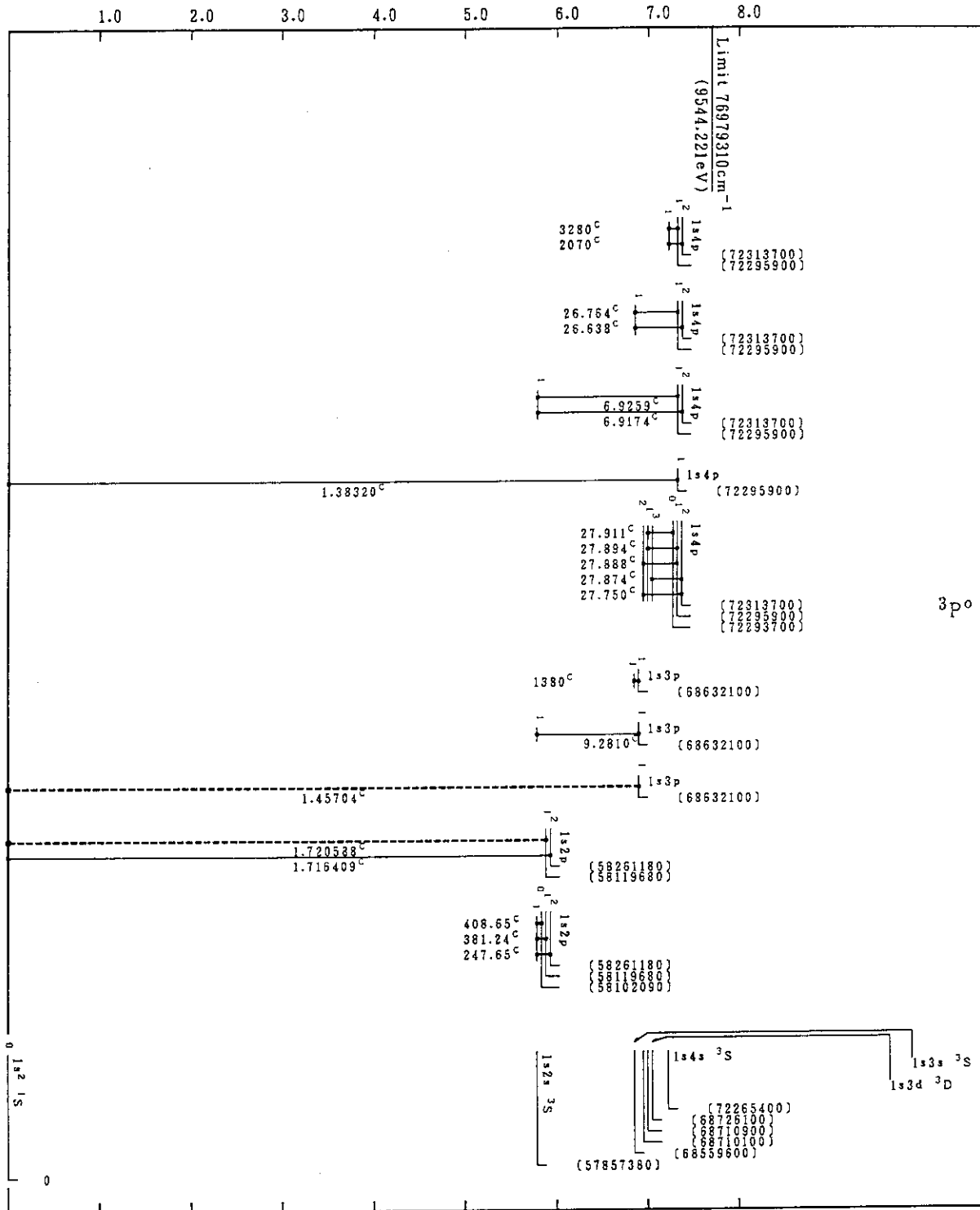

Co XXVI (He-Sequence)

Energy (in  $10^7 \text{cm}^{-1}$ )

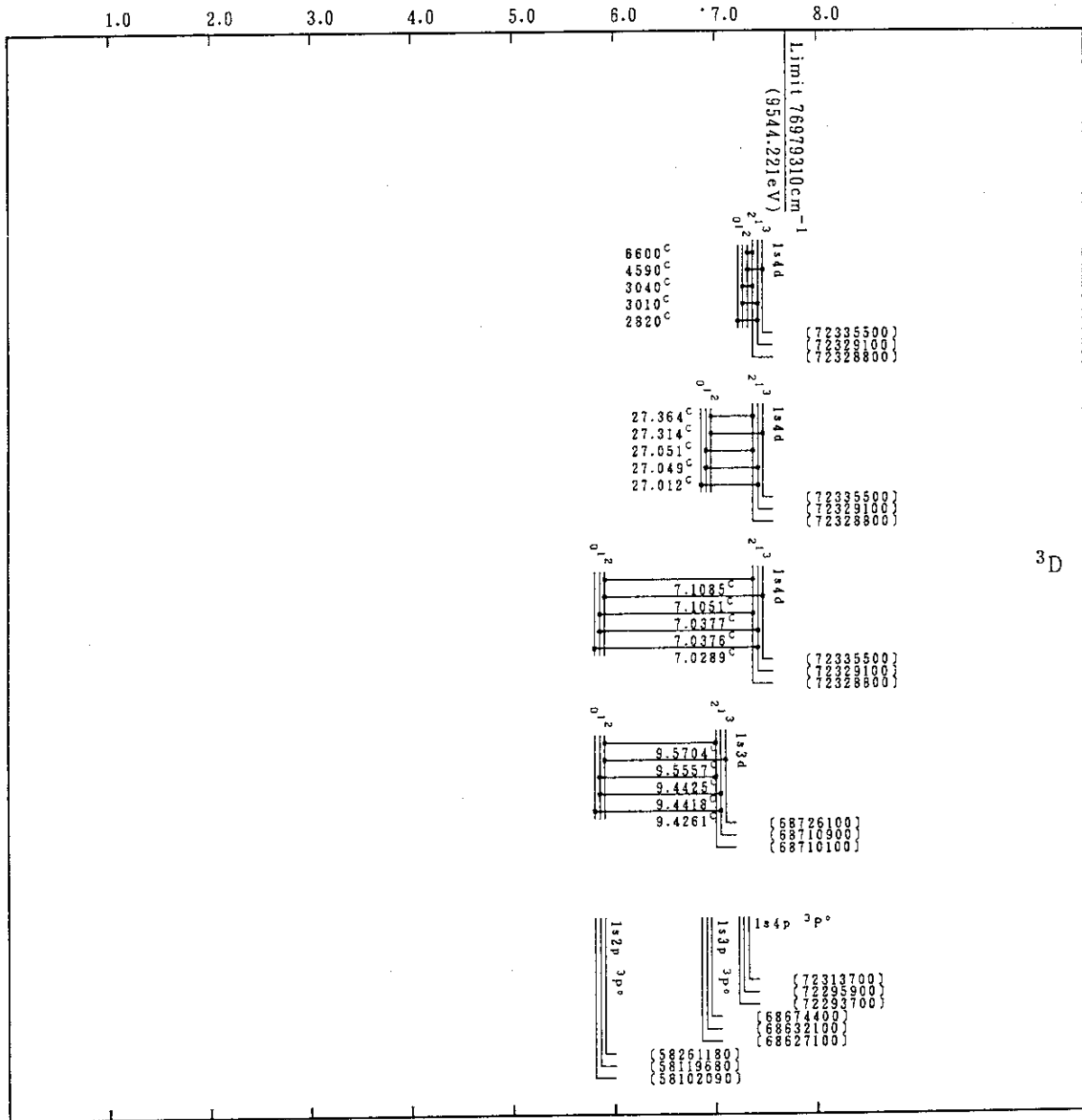

3D

Co XXVI (He-Sequence)

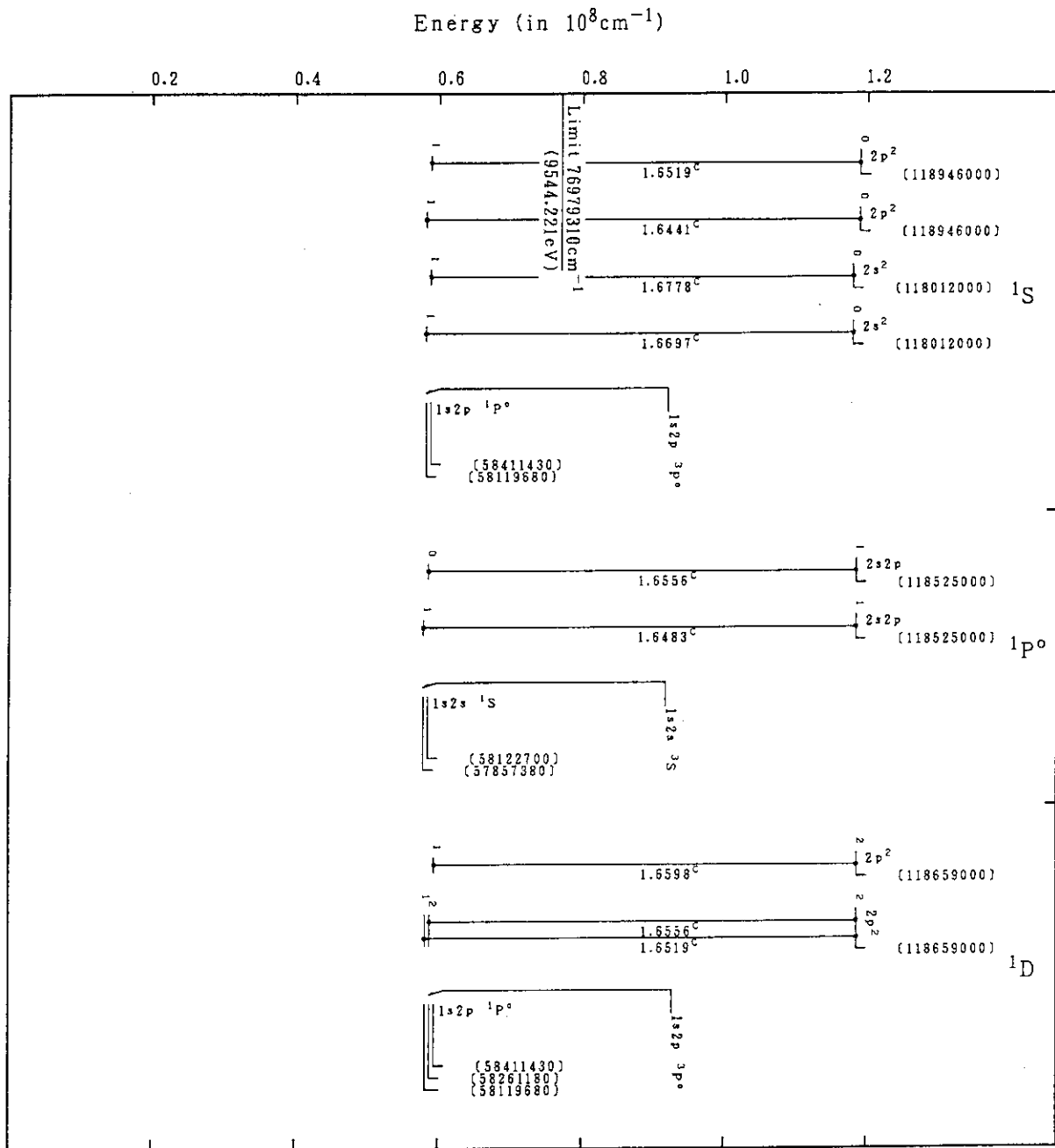

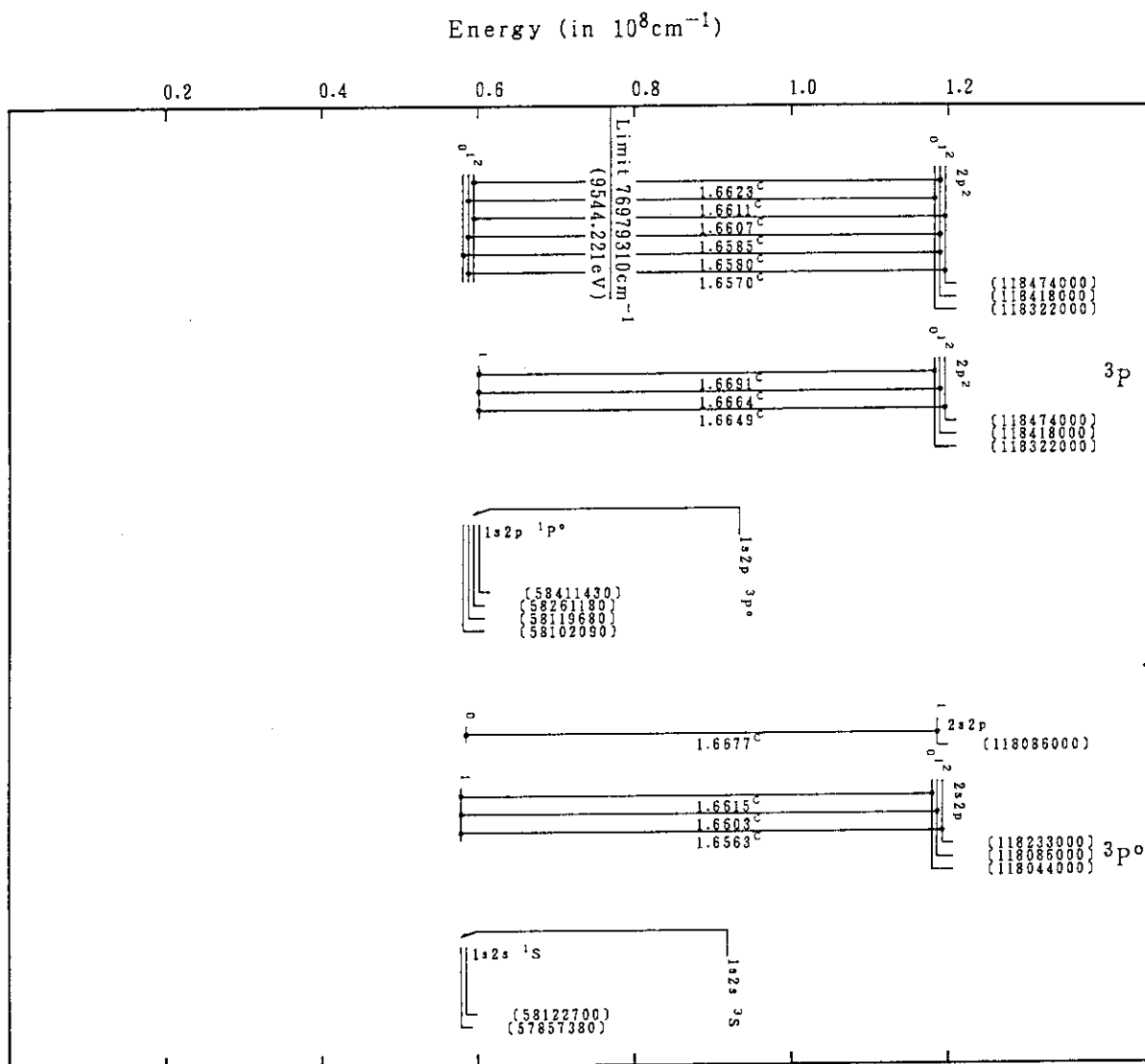

Co XXVI (He-Sequence)



Energy (in  $10^7 \text{cm}^{-1}$ )

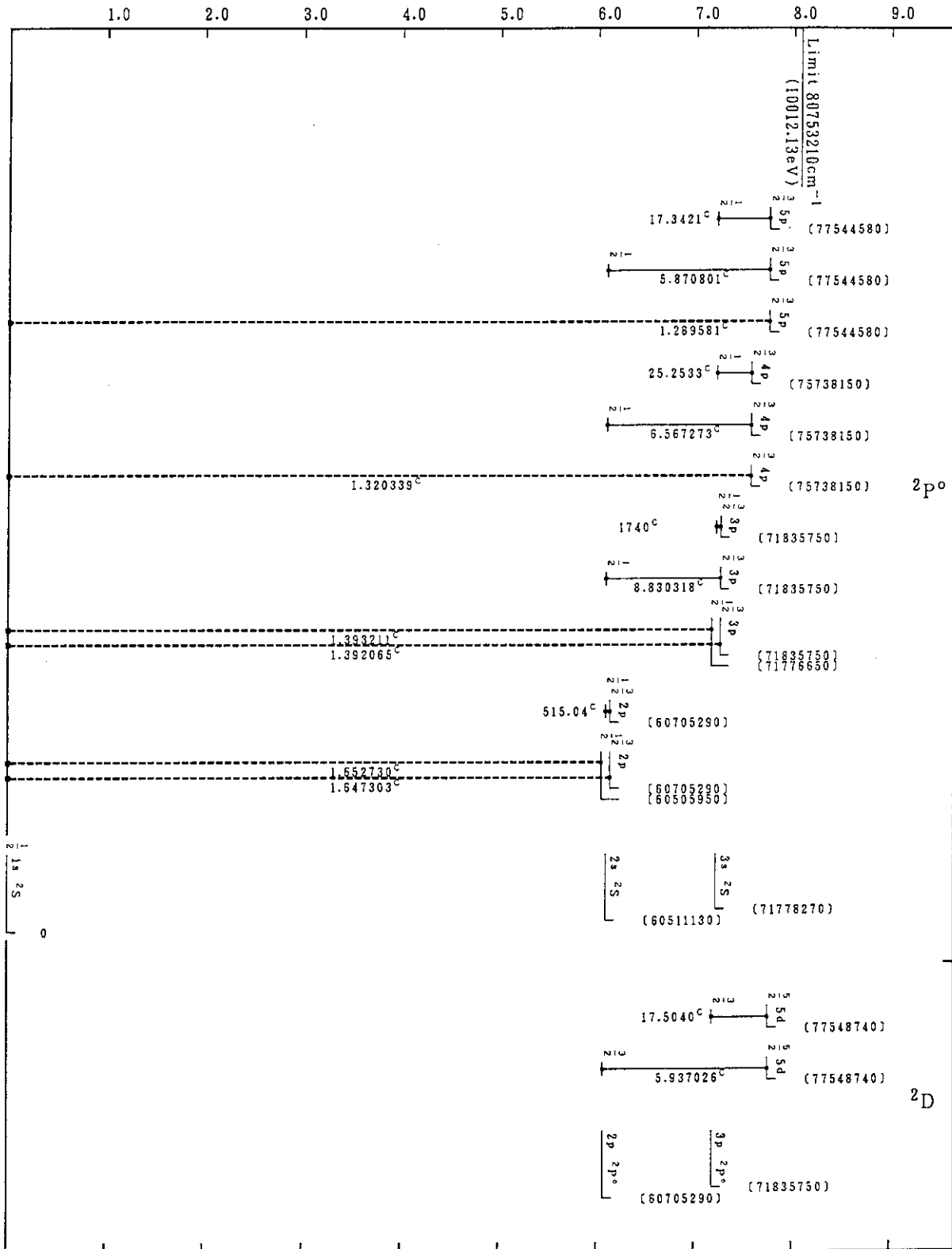

Co XXVII (H-Sequence)

