

STUDY OF THE APPLICATION OF NEAR-REAL-TIME
MATERIALS ACCOUNTANCY TO
SAFEGUARDS FOR REPROCESSING FACILITIES

September 1983

Koji IKAWA, Hitoshi IHARA, Hideo NISHIMURA,
Mitsuho HIRATA, Hirotaka SAKURAGI*, Masaru IDO**

Toshio SAWAHATA*, Masayori TSUTSUMI*, Masayuki IWANAGA*,
Naohiro SUYAMA*

James E. Lovett*

JAERI-Mレポートは、日本原子力研究所が不定期に公刊している研究報告書です。
入手の間合わせは、日本原子力研究所技術情報部情報資料課（〒319-11茨城県那珂郡東海村）あて、お申しこしてください。なお、このほかに財団法人原子力弘済会資料センター（〒319-11茨城県那珂郡東海村日本原子力研究所内）で複写による実費頒布をおこなっております。

JAERI-M reports are issued irregularly.

Inquiries about availability of the reports should be addressed to Information Section, Division of Technical Information, Japan Atomic Energy Research Institute, Tokai-mura, Naka-gun, Ibaraki-ken 319-11, Japan.

©Japan Atomic Energy Research Institute, 1983

編集兼発行 日本原子力研究所
印刷 いばらき印刷株式会社

STUDY OF THE APPLICATION OF NEAR-REAL-TIME MATERIALS ACCOUNTANCY
TO
SAFEGUARDS FOR REPROCESSING FACILITIES

Koji IKAWA, Hitoshi IHARA, Hideo NISHIMURA, Mitsuho HIRATA
Hirotaka SAKURAGI^{*}, Masaru IDO^{**}

Japan Atomic Energy Research Institute

Toshio SAWAHATA, Masayori TSUTSUMI, Masayuki IWANAGA,
Naohiro SUYAMA
Power Reactor and Nuclear Fuel Development Corporation

James E. Lovett
International Atomic Energy Agency

(Received September 5, 1983)

This report describes the results of TASTEX task F, the basic purpose of which was to investigate the feasibility of applying the basic concepts of near-real-time materials accountancy to small or medium-sized spent fuel reprocessing facilities, using the PNC-Tokai facility as a model. The background of Task-F and the proposed IAEA requirements on reprocessing plant safeguards are briefly shown. A model of near-real-time materials accountancy based on weekly material balances covering the entire process MBA is outlined, and the effectiveness of this model is evaluated based on simulation and analysis procedures developed for the study. The results show that the proposed materials accountancy model should provide sufficient information to satisfy IAEA guidelines for detection goals.

Field testing of the model began in 1980, and the preliminary evaluation of this field test data shows that weekly in-process physical inventories are possible without affecting process operations.

This report also describes studies related to IAEA verification procedures, and identifies necessary further work.

Keywords: N.R.T. Accountancy, PNC Reprocessing Plant, Advanced Safeguards,
TASTEX Project, N.R.T.A. Field Test

* Nippon Computer Bureau Ltd.

** ISL

再処理施設保障措置のための N.R.T. 核物質計量の適用研究

日本原子力研究所

猪川浩次・井原 均・西村秀夫・平田実穂・桜木広隆*・井戸 勝**

動力炉・核燃料開発事業団

沢畑稔雄・堤 正順・岩永雅之・陶山尚宏

International Atomic Energy Agency

James E. Lovett

(1983年9月5日受理)

本報告書は TASTEX プロジェクトの Task-F の成果を記述したものである。TASTEX Task-F の基本的な目的は、ニア・リアル・タイム核物質計量管理の考え方が小規模ないし中規模の再処理施設に対して適用可能かどうかを、東海再処理施設をモデル工場として作りながら検討するということであった。この Task-F の背景と再処理施設に対して提案されている IAEA の保障措置上の要請について記述する。次に、工程物質収支区域全体に対する週毎の物質収支を採ることを基本とするニア・リアル・タイム計量管理モデルの概要を記述し、その有効性をシミュレーションと統計解析により評価した結果について述べる。最後に東海再処理工場で実施したフィールド・テストの結果について述べる。本研究の結論は、ニア・リアル・タイム計量管理システムを東海再処理工場に適用することは可能であり、かつ、そうすることによって IAEA の保障措置目標を、施設への影響を最少にしなが達成できよう、というものであった。

* 日本コンピューター・ビューロー

** 情報システム研究所(株)

CONTENTS

ABSTRACT (English)	i
ABSTRACT (Japanese)	ii
TABLES	iii
FIGURES	Xiii
EXECUTIVE SUMMARY	1
1. INTRODUCTION	19
1.1 Background of the Study	19
1.2 Purpose and Scope of the Study	20
1.3 Progress of the Study	21
1.4 Goal Quantities and Timeliness Criteria	23
2. DEFINITION AND DESCRIPTION OF THE BASIC CONCEPT OF NEAR-REAL-TIME MATERIALS ACCOUNTANCY	25
2.1 General	25
2.2 Basic Requirements	26
2.3 Condition for Backfitting	28
3. THE MODEL PLANT	29
3.1 Plant Characteristics	29
3.2 Process Description	29
3.2.1 Receiving and Storage	30
3.2.2 Chop and Leach Area	30
3.2.3 Chemical Separation and Purification Process	30
3.2.4 Uranium Product Storage	31
3.2.5 Plutonium Product Storage	31
3.3 Material Flow and Holdup	31
3.4 Materials Accountancy Measurements	32
3.4.1 Material Balance Areas and Measurement Points for Materials Accountancy	32
3.4.2 Measurement Methods	33
4. N.R.T. MATERIALS ACCOUNTANCY MODEL FOR THE MODEL PLANT	47
4.1 General	47
4.2 Measurement of Input Quantities	47
4.3 Measurement of Output Quantities	48
4.3.1 Product Solution	48
4.3.2 Waste Materials	48

4.4	Measurement of Physical Inventory	48
4.4.1	General	48
4.4.2	Buffer Storage Vessels	49
4.4.3	Product Evaporator	50
4.4.4	Mixer-Settler Extraction Systems	51
4.5	Statistical Analysis Method	52
5.	EFFECTIVENESS EVALUATION BY MODELING AND SIMULATION STUDIES	57
5.1	Evaluation Method of N.R.T. Materials Accountancy Effectiveness	57
5.1.1	General	57
5.1.2	Measurement Simulation	57
5.1.3	Analysis of Accountancy Data	65
5.1.4	Expression of Decision Analysis	66
5.2	Assumptions and Conditions in Simulation Studies ..	68
5.2.1	Plant Operating Mode	69
5.2.2	Fuel Type Processed	70
5.2.3	Measurement Method and Measurement Accuracies ..	70
5.2.4	Measurement Equipment Recalibration Frequency ...	70
5.2.5	N.R.T. Accountancy Material Balance Period	71
5.2.6	Method of In-process Physical Inventory Taking ..	71
5.2.7	Diversion Mode	71
5.3	Performance of Materials Accountancy under Normal Operating Conditions	73
5.3.1	Fluctuation of the Unmeasured In-process Plutonium Holdups	73
5.3.2	Measurement Accuracies	74
5.3.3	Frequency of Calibration	76
5.3.4	Contribution of Error Components to σ_{CUMUF}	77
5.4	Diversion Sensitivity Analyses	77
5.4.1	General Consideration	78
5.4.2	Sensitivity Against each Diversion Mode	82
5.4.3	Effect of the length of a NRTMBP	83
5.4.4	Complete In-process Inventory Taking	84
5.4.5	Application of NDA Measurement to Analysis of Feeding Vessel	84
5.4.6	Clean-out PIT	85

6.	FIELD TESTING OF THE N.R.T. MATERIALS ACCOUNTANCY MODEL	217
6.1	Summary of the Field Test	217
6.2	Planning of the Field Test	218
6.2.1	Working Group	218
6.2.2	Procedure for the Field Test of In-process Inventory	218
6.3	Implementation of the Field Test	220
6.3.1	Volume Measurement	220
6.3.2	Sampling	221
6.3.3	Chemical Analysis	221
6.3.4	Collection of Data	222
6.4	Evaluation of Manpower Required for Plant Operators	222
6.4.1	Volume Measurement	223
6.4.2	Sampling	223
6.4.3	Manpower Related to Chemical Analyses	223
6.5	Future Subject with Regard to Field Testing	223
6.5.1	Estimation of Inventories in Mixer-settler System	224
6.5.2	Measurement Accuracy	224
7.	EVALUATION OF THE N.R.T. MATERIALS ACCOUNTANCY MODEL	233
7.1	Evaluation of Field Test Data	233
7.1.1	N.R.T. Accounting Data	233
7.1.2	Evaluation of Field Test Data	234
7.2	Improvement of Materials Measurement and Estimation	237
7.2.1	Bias Estimation and Correction	237
7.2.2	Estimation of Inventory Hold-up in Mixer-Settler Systems	238
7.3	Verification for International Safeguards	239
8.	RECOMMENDATIONS AND CONCLUSIONS	259
8.1	Recommendations for Future Work	259
8.1.1	General	259
8.1.2	Development of Integrated Safeguards System	259
8.1.3	Development of Improved Model for Estimation of Inventory Hold-up in Mixer-settler Systems ...	260

8.1.4 Investigation of Source of Measurement Bias	
Across the Process MBA	261
8.2 Conclusions	261
ACKNOWLEDGEMENTS	262
REFERENCES	263

目 次

要 旨 (英語)	i
要 旨 (日本語)	ii
表リスト	X
図リスト	Xiii
1. 序 論	19
1.1 研究の背景	19
1.2 研究の目的と範囲	20
1.3 研究の経過	21
1.4 検出目標量と検出のタイムリネス	23
2. Near-Real-Time核物質計量の基本概念の定義と説明	25
2.1 概 要	25
2.2 基本的要請	26
2.3 既施設への適用条件	28
3. モデル・プラント	29
3.1 プラントの特性	29
3.2 工程の説明	29
3.2.1 受入れ及び貯蔵	30
3.2.2 剪断及び溶解区域	30
3.2.3 化学的分離と精製工程	30
3.2.4 ウラン製品貯蔵	31
3.2.5 プルトニウム製品貯蔵	31
3.3 核物質の流れとホールドアップ	31
3.4 核物質計量管理のための測定	32
3.4.1 核物質計量のための物質収支区域と測定点	32
3.4.2 測定方法	33
4. モデルプラントに対する N.R.T. 核物質計量モデル	47
4.1 概 要	47
4.2 入力量の測定	47
4.3 出力量の測定	48
4.3.1 製品溶液	48
4.3.2 廃棄物	48
4.4 実在庫量の測定	48
4.4.1 概 要	48
4.4.2 中間貯蔵タンク	49

4.4.3	蒸発缶	50
4.4.4	ミキサセトラ溶媒抽出システム	51
4.5	統計分析法	52
5.	モデル化とシミュレーション研究による有効性評価	57
5.1	N.R.T.核物質計量の有効性評価法	57
5.1.1	概要	57
5.1.2	測定シミュレーション	57
5.1.3	計量データの分析	65
5.1.4	決定分析の表現法	66
5.2	シミュレーション研究の仮定と条件	68
5.2.1	プラント運転モード	69
5.2.2	処理する燃料の種類	70
5.2.3	測定方法とその精度	70
5.2.4	測定機器の較正頻度	70
5.2.5	N.R.T.計量の物質収支期間	71
5.2.6	工程内在庫量測定の方法	71
5.2.7	転用モード	71
5.3	通常運転下における核物質計量の性能	73
5.3.1	運転下における未測定のプロトニウム・ホールドアップとその変動	73
5.3.2	測定精度	74
5.3.3	較正頻度	76
5.3.4	σ_{CUMUF} への各誤差要素の寄与	77
5.4	転用に対する感度解析	77
5.4.1	一般的考察	78
5.4.2	各転用モードに対する感度	82
5.4.3	物質収支期間(NRTMBP)の違いによる効果	83
5.4.4	運転中工程内在庫の完全測定	84
5.4.5	インプット供給槽の分析に対するNDAの適用	84
5.4.6	クリーン・アウト実在庫測定	85
6.	N.R.T.核物質計量モデルのフィールド・テスト	217
6.1	フィールド・テストの概要	217
6.2	フィールド・テストの実施計画	218
6.2.1	ワーキング・グループ	218
6.2.2	工程内在庫測定のフィールド・テスト実施手順	218
6.3	フィールド・テストの実施	220
6.3.1	容積の測定	220
6.3.2	サンプリング	221
6.3.3	化学分析	221

6.3.4	データの収集	222
6.4	プラント運転者に要求されるマンパワーの評価	222
6.4.1	容積の測定	223
6.4.2	サンプリング	223
6.4.3	化学分析に影響するマンパワー	223
6.5	フィールド・テストに関する将来の検討課題	223
6.5.1	ミキサセトラ抽出システムの在庫量推定	224
6.5.2	測定精度	224
7.	N.R.T.核物質計量モデルの評価	233
7.1	フィールド・テスト・データの評価	233
7.1.1	N.R.T.計量データ	233
7.1.2	フィールド・テスト・データの評価	234
7.2	物質の測定及び推定における改良	237
7.2.1	バイアスの推定と修正	237
7.2.2	ミキサセトラ抽出システム内の在庫量の推定	238
7.3	国際保障措置のための検認	239
8.	勧告及び結論	259
8.1	将来の仕事に対する勧告	259
8.1.1	概要	259
8.1.2	総合的保障措置システムの開発	259
8.1.3	ミキサセトラ抽出システム内の在庫量推定のための改良モデルの開発	260
8.1.4	工程物質収支区域における測定バイアスの原因調査	261
8.2	結論	261
	謝辞	262
	参考文献	263

TABLES

1.1	Expected Accuracy (Standard Deviation) of a Material Balance and Verification Accuracy Goals Expressed as a Percent of Inventory or Throughput	24
3.1	Process Unit No. and Corresponding Name of Process Unit	36
3.2	Potential Variations of Pu-holdups Induced by Fluctuations in Characteristics of Input Fuel Assemblies	37
3.3	Measurement Methods for Main KMPs	38
5.1	Alarm Classification for the Alarm-sequence Chart	67
5.2	Simulated Operation Modes	86
5.3	Assumptions and Conditions for Simulation Studies	87
5.4	Measurement Methods and Relative Percentage Standard Deviation of a Single Measurement - (1)	88
5.5.	Measurement Methods and Relative Percentage Standard Deviation of a Single Measurement - (2)	89
5.6	Simulation Cases Studied	90
5.7	Exact Material Balance with and without Diversion	91
5.8	In-process Inventory Fluctuation	73
5.9(1)	Pu Concentration at the Equilibrium State (S.S.1-1)	92
5.9(2)	Pu Concentration at the Equilibrium State (S.S.1-2)	93
5.9(3)	Pu Concentration at the Equilibrium State (S.S.1-3)	94
5.9(4)	Pu Concentration at the Equilibrium State (S.S.1-4)	95
5.9(5)	Pu Concentration at the Equilibrium State (S.S.1-5)	96
5.9(6)	Pu Concentration at the Equilibrium State (S.S.1-6)	97
5.10	Simple Algebraic Mean of σ_{MUFd}	76
5.11	Comparison between MUF of S.S.1-8 and One of S.S.4	98
5.12(1)	Comparison of MUF_d and σ_{MUFd} for Four Measurement Error Types with No Diversion Case S.S.1-5-1	99
5.12(2)	Comparison of CUMUF and σ_{CUMUF} for Four Measurement Error Types with No Diversion Case S.S.1-5-1	100

5.13(1)	MUF _d and σ_{MUFd} for Different Recalibration Frequencies with No Diversion Case of S.S.1-5-1	101
5.13(2)	MUF _d and σ_{MUFd} for Different Recalibration Frequencies with No Diversion Case of S.S.1-8	102
5.13(3)	MUF _d and σ_{MUFd} for Different Recalibration Frequencies with No Diversion Case of S.S.4	103
5.14(1)	Components of Variance (and Relative Standard Deviation) of CUMUF at 10th near-real-time Material Balance Period with No Diversion Case of S.S.1-5-1	104
5.14(2)	Components of Variance (and Relative Standard Deviation) of CUMUF at 20th near-real-time Material Balance Period with No Diversion Case of S.S.1-5-1	105
5.15	True-Diversion and Estimation of Diversion for Uniform Diversion Cases	106
5.16	Material Balance for Uniform Diversion Case	107
5.17	Alarm Generation Chart for Uniform Diversion Case	108
5.18(1)	Alarm Generation Chart for Tree N.R.T. Material Periods; Diversion Amounts are $1 \sigma_{MUFd}$ per NRTMBP	109
5.18(2)	Alarm Generation Chart for Three N.R.T. Material Balance Periods; Diversion Amounts are 8 kgs per year	110
5.19	Alarm Generation Chart for Partial and Full PITs with Uniform Diversion Cases; Diversion Amounts are 8 kgs per	111
5.20	Alarm Generation Chart for each Diversion Mode; NDA of 20% Accuracy is Assumed for In-process Inventory	112
6.1	Sampling Time Schedule (Frequency) for In-process Inventory ..	225
6.2	In-process Inventory Analytical Items, Accuracy and time of Measurement	226
6.3	In-process Inventory Estimation	227
6.4	Input Accountability Tank (IAV; Q _I)	228
6.5	Pu Product Accountability Tank (PAV; Q _P)	228
6.6	Plant Operation Time Schedule During Field Test	229
6.7	In-process Inventory Takings Performed	230

7.1	Input Batch Accounting Data in C-1 and C-2 Campaigns (Plutonium)	241
7.2	Plutonium Product Accounting Data of MBA2 in C-1 and C-2 Campaigns	248
7.3	Waste Accounting Data of MBA2 in C-1 and C-2 Campaigns	250
7.4	In-process Inventory Data in C-1 Campaign	251
7.5	In-process Inventory Data in C-2 Campaign	252
7.6	In-process Material Balance Data in C-1 and C-2 Campaigns ...	253
7.7	In-process Plutonium Inventory and Its Fluctuation in MBA2 ..	235

FIGURES

3.1	General Scheme of Chemical Treatment	39
3.2	Schematic Flowsheet of the Model Reprocessing Plant	40
3.3	Flowsheet of Co-decontamination and Partition Process	41
3.4	Flowsheet of Purification Processes of Uranium and Plutonium	42
3.5	Model Reprocessing Plant Process Flow	43
3.6	Schematic Diagram of Process Accountability Including Dynamic Accounting	44
3.7	Volume Measurement System of Input Accountability Vessel	45
3.8	Sampling System of Input Accountability Vessel	45
3.9	Volume Measurement and Sampling System for Pu-product	46
3.10	Weighing and Sampling System for U-product (UO ₃ -powder)	46
4.1	Graphic representation of variations in volume of solution in the major measurement points. Three inventory cut-off points are also indicated. Each point is chosen at a particular point of time immediately after the evaporator become empty and before evaporator feed is resumed	54
4.2	Block Diagram of the Decision-analysis	55
5.1	Volume Measurements and Sample Takings Used to Determine a Batch for Transfer	64
5.2	CUMUF and Uniform Diversion Tests for S.S.1-1 and S.S.1-2; Simulation Period; 6 months	114
5.3	CUMUF and Uniform Diversion Tests for S.S.1-3 and S.S.1-4; Simulation Period; 6 months	116
5.4	CUMUF and Uniform Diversion Tests for S.S.1-5-1 and S.S.1-6; Simulation Period; 6 months	118
5.5	CUMUF and Uniform Diversion Tests for S.S.1-7 and S.S.1-8; Simulation Period; 6 months	120
5.6	CUMUF and Uniform Diversion Tests for S.S.1-9 and S.S.1-10; Simulation Period; 4 months	122
5.7	CUMUF and Uniform Diversion Tests for S.S.1-5-1 with Different Diversion Ratio; Simulation Period; 6 months	124

5.8	CUMUF and Uniform Diversion Tests for S.S.1-7 with Different Diversion Ratio; Simulation Period; 6 months 126
5.9	CUMUF and Uniform Diversion Tests for S.S.1-8 with Different Diversion Ratio; Simulation Period; 6 months 128
5.10	CUMUF and Uniform Diversion Tests for S.S.1-9 with Different Diversion Ratio; Simulation Period; 4 months 130
5.11	CUMUF and Uniform Diversion Tests for S.S.1-10 with Different Diversion Ratio; Simulation Period; 4 months 132
5.12	CUMUF and Uniform Diversion Tests for S.S.4 with Different Diversion Ratio; Simulation Period; 6 months 134
5.13	CUMUF and Uniform Diversion Tests for Different n.r.t. Material Balance Periods with S.S.1-5-1 (no diversion); Simulation Period; 6 months 136
5.14	CUMUF and Uniform Diversion Tests for Different n.r.t. Material Balance Periods with S.S.1-5-1 (uniform diversion of 4 kgs Pu per 6 months) 138
5.15	CUMUF and Uniform Diversion Tests for Different n.r.t. Material Balance Periods with S.S.1-5-1 (random diversion (+) of 4 kgs Pu per 6 months) 140
5.16	CUMUF and Uniform Diversion Tests for Different n.r.t. Material Balance Periods with S.S.1-5-1 (single diversion (+) of 4 kgs Pu per 6 months) 142
5.17	CUMUF and Uniform Diversion Tests for Different n.r.t. Material Balance Periods with S.S.1-5-1 (uniform diversion of 8.8 kgs Pu per 6 months) 144
5.18	CUMUF and Uniform Diversion Tests for Different n.r.t. Material Balance Periods with S.S.1-5-1 (random diversion (+) of 7.9 kgs Pu per 6 months) 146
5.19	CUMUF and Uniform Diversion Tests for Different n.r.t. Material Balance Periods with S.S.1-5-1 (single diversion (+) of 7.0 kgs Pu per 6 months) 148
5.20	CUMUF and Uniform Diversion Tests for Different n.r.t. Material Balance Periods with S.S.1-8 (no diversion); Simulation Period; 6 months 150
5.21	CUMUF and Uniform Diversion Tests for Different n.r.t. Material Balance Periods with S.S.1-8 (uniform diversion of 4 kgs Pu per 6 months) 152

5.22	CUMUF and Uniform Diversion Tests for Different n.r.t. Material Balance Periods with S.S.1-8 (uniform diversion (+) of 3.9 kgs Pu per 6 months)	154
5.23	CUMUF and Uniform Diversion Tests for Different n.r.t. Material Balance Periods with S.S.1-8 (single diversion (+) of 3.9 kgs Pu per 6 months)	156
5.24	CUMUF and Uniform Diversion Tests for Different n.r.t. Material Balance Periods with S.S.1-8 (uniform diversion of 7.1 kgs Pu per 6 months)	158
5.25	CUMUF and Uniform Diversion Tests for Different n.r.t. Material Balance Periods with S.S.1-8 (random diversion (+) of 7.8 kgs Pu per 6 months)	160
5.26	CUMUF and Uniform Diversion Tests for Different n.r.t. Material Balance Periods with S.S.1-8 (single diversion (+) of 8.9 kgs Pu per 6 months)	162
5.27	CUMUF and Uniform Diversion Tests for Different n.r.t. Material Balance Periods with S.S.4 (no diversion); Simulation Period; 6 months	164
5.28	CUMUF and Uniform Diversion Tests for Different n.r.t. Material Balance Periods with S.S.4 (uniform diversion of 4.1 kgs Pu per 6 months)	166
5.29	CUMUF and Uniform Diversion Tests for Different n.r.t. Material Balance Periods with S.S.4 (uniform diversion (+) of 3.8 kgs Pu per 6 months)	168
5.30	CUMUF and Uniform Diversion Tests for Different n.r.t. Material Balance Periods with S.S.4 (single diversion (+) of 4.4 kgs Pu per 6 months)	170
5.31	CUMUF and Uniform Diversion Tests for Different n.r.t. Material Balance Periods with S.S.4 (uniform diversion of 8.1 kgs Pu per 6 months)	172
5.32	CUMUF and Uniform Diversion Tests for Different n.r.t. Material Balance Periods with S.S.4 (random diversion (+) of 7.6 kgs Pu per 6 months)	174
5.33	CUMUF and Uniform Diversion Tests for Different n.r.t. Material Balance Periods with S.S.4 (single diversion (+) of 8.9 kgs Pu per 6 months)	176
5.34	CUMUF and Uniform Diversion Tests for S.S.1-5-2; Simulation Period; 10 months	178

5.35	Comparison of Detection Sensitibilities in Terms of Different In-process PIT models for S.S.1-7 (no diversion)	180
5.36	Comparison of Detection Sensitibilities in Terms of Different In-process PIT models for S.S.1-7 (uniform diversion of 4.0 kgs Pu per 6 months)	182
5.37	Comparison of Detection Sensitibilities in Terms of Different In-process PIT models for S.S.1-8 (no diversion)	184
5.38	Comparison of Detection Sensitibilities in Terms of Different In-process PIT models for S.S.1-8 (uniform diversion of 4.0 kgs Pu per 6 months)	186
5.39	Comparison of Detection Sensitibilities in Terms of Different In-process PIT models for S.S.1-10 (no diversion)	188
5.40	Comparison of Detection Sensitibilities in Terms of Different In-process PIT models for S.S.1-10 (uniform diversion of 2.7 kgs Pu per 4 months)	190
5.41	Comparison of Detection Sensitibilities in Terms of Different In-process PIT models for S.S.4 (no diversion)	192
5.42	Comparison of Detection Sensitibilities in Terms of Different In-process PIT models for S.S.4 (uniform diversion of 4.0 kgs Pu per 6 months)	194
5.43	CUMUF and Uniform Diversion Tests for S.S.1-5-1 of Different models of Diversion (+) of 4.0 kgs Pu per TMBP. NDA of 20% Accuracy is Assumed for n.r.t.a. KMP, D1	196
5.44	CUMUF and Uniform Diversion Tests for S.S.1-8 of Different models of Diversion (+) of 4.0 kgs Pu per TMBP. NDA of 20% Accuracy is Assumed for n.r.t.a. KMP, D1	198
5.45	CUMUF and Uniform Diversion Tests for S.S.1-8 of Different models of Diversion (+) of 4.0 kgs Pu per TMBP. NDA of 20% Accuracy is Assumed for n.r.t.a. KMP, D1	200
5.46	CUMUF and Uniform Diversion Tests for S.S.1-5-1 of Different models of Diversion (+) of 8.0 kgs Pu per TMBP. NDA of 20% Accuracy is Assumed for n.r.t.a. KMP, D1	202
5.47	CUMUF and Uniform Diversion Tests for S.S.1-8 of Different models of Diversion (+) of 8.0 kgs Pu per TMBP. NDA of 20% Accuracy is Assumed for n.r.t.a. KMP, D1	204
5.48	CUMUF and Uniform Diversion Tests for S.S.4 of Different models of Diversion (+) of 8.0 kgs Pu per TMBP. NDA of 20% Accuracy is Assumed for n.r.t.a. KMP, D1	206

5.49	CUMUF and Uniform Diversion Tests for Different Estimation Methods for Unmeasured Inventories with S.S.1-9-2 (no diversion); Simulation Period; 8 months	208
5.50	CUMUF and Uniform Diversion Tests for Different Estimation Methods for Unmeasured Inventories with S.S.1-9-2 (uniform diversion of 8 kgs Pu per year); Simulation Period; 8 months	210
5.51	CUMUF and Uniform Diversion Tests for Different Estimation Methods for Unmeasured Inventories with S.S.1-10-2 (no diversion); Simulation Period; 8 months	212
5.52	CUMUF and Uniform Diversion Tests for Different Estimation Methods for Unmeasured Inventories with S.S.1-10-2 (uniform diversion); Simulation Period; 8 months	214
6.1	Measurement Points for the In-process Inventory	231
6.2	A Campaign Plant Operation and 1st Part Field Test Time Schedule	232
7.1	Adjusted n.r.t. Material Balance (MUF_d) in C-1 and C-2 Campaigns	254
7.2	CUMUF Data Base on Adjusted MUF_d Data in C-1 and C-2 Campaigns	255
7.3	Average Loss (uniform diversion) Based on the Two-state Kalman Filter Estimate in C-1 and C-2 Campaigns	256
7.4	Alarm-sequence Chart Based on CUMUF Tests	257
7.5	Alarm-sequence Chart Based on Uniform Diversion Tests	257
7.6	MUF_d Corrected for Biases of Different Estimates	258
7.7	CUMUF Based on MUF_d Corrected for Biases of Different Estimates	258

EXECUTIVE SUMMARY

PURPOSE OF THE TASK

The purpose of Task F was to investigate the feasibility of applying the basic concepts of near-real-time materials accountancy to small or medium-sized spent fuel reprocessing facilities, using the facility at Tokai as a model.

The feasibility was investigated in four major areas:

- (a) development of an effective near-real-time materials accountancy system which could be implemented at an acceptable cost in existing reprocessing facilities,
- (b) evaluation of selected capabilities needed for such a system, using evaluation parameters including measurement instrument selection, and inventory estimation techniques,
- (c) evaluation of the capability and effectiveness of the proposed materials accountancy system using a computer simulation model, and
- (d) study of approaches to IAEA independent verification of near-real-time material balance data on the part of international safeguards inspectors.

This study has been carried out as a joint effort involving a number of persons from IAEA, LANL, PNC, and JAERI, although all of them have contributed to a part of all of these areas, the area(a) has been covered mainly by the people from IAEA, PNC and JAERI, the area(b) by LANL, the area(c) by JAERI and PNC, and the area(d) by IAEA and LANL.

This report covers all four areas, except that only a part of (b), taken from the LANL report for TASTEX Task F (LA-8070-MS), has been included.

DESCRIPTION OF TECHNIQUE, EQUIPMENT, AND PROCEDURESDefinition and Description of the Basic N.R.T. Accountancy Model

The concept of near-real-time materials accountancy has undergone extensive evolution during the period of this study. Early definitions spoke of an extensive use of in-line non-destructive instrumentation, and assumed that material balances would be prepared both for short time periods and for small portions of the total process area. As the study has

progressed, however, it has become apparent that weekly material balances covering the entire process MBA provide sufficient information to satisfy IAEA guidelines for small or medium-sized facilities, and that indeed even for larger facilities the potential gain from more frequent material balances needs to be examined carefully in relation to the extra effort required for their preparation.

The study of near-real-time materials accountancy for the PNC-Tokai facility is based on the following:

- (a) weekly "in-process" physical inventories would be taken of plutonium in the process MBA,
- (b) measurements of both flow and inventory quantities would be either by conventional chemical methods or by instrumental (NDA) methods, as may be convenient in specific situations,
- (c) all measurements would be completed, and the resulting MUF would be determined and evaluated, within a period of about two or three days after the in-process inventory, and,
- (d) evaluation of MUF data would be based on statistical techniques which recognize, and derive the maximum information from, sequences of short term material balances.

In-process Physical Inventories

A schematic diagram of process accountability for the PNC-Tokai facility is shown in Fig. E.1. As shown in that diagram, some 13 transfer measurement points have been identified for conventional materials accountancy purposes. For the purposes of near-real-time materials accountancy, additional six inventory measurement points were defined. (Inventory points 5 and 6 relate to uranium rather than plutonium, and in practice were not used). These inventory measurement points all relate to buffer storage tanks feeding the first, second, and third extraction cycles and the plutonium product evaporator.

No means was identified for inventorying plutonium in the product evaporator, so the specification was adopted that in-process physical inventories would always be taken when the evaporator was empty, and prior to restarting evaporation of the next batch. The model design flow sheet calls for discharging the evaporator once every 24 hours, so this specification is only a minor constraint on the timing of the in-process physical inventories.

If the plutonium product evaporator is empty, the model design flow sheet estimate of the total plutonium inventory in the process MBA is about 16.8 kgs, with 12.9 kgs of that amount being in the four identified buffer storage tanks. Essentially all of the remainder (3.8 kgs), was estimated to be in the solvent extraction system. Section 4.4 discusses the question of estimating the plutonium inventory in the solvent extraction system. Except for the work reported there, the task F study has assumed that the solvent extraction system inventory would be relatively constant, and could be so treated.

Measurement Methods

Since in-process inventories are to be taken at weekly intervals, and since the IAEA guideline for detection of possible abrupt diversions calls for detection within one to three weeks, the specifications for measurement methods neither require nor forbid the use of instrumental or NDA methods. Since each of the four buffer storage tanks normally are sampled daily for process control purposes anyway, it was convenient in this study to assume that conventional measurement methods would be used. Measurement methods used or considered for possible use are listed in Table E.1.

As a part of its contribution to Task F study, investigators at the Los Alamos National Laboratory examined possible alternative NDA measurement methods. In selecting an instrument to measure input dissolver solutions, a major consideration is the intense fission product gamma ray activity. In addition, the high U/Pu ratio rules out absorption edge densitometry. X-ray fluorescence spectroscopy, using an X-ray tube to excite the plutonium fluorescence X-rays, is the only technique that can overcome the gamma-ray background, and is recommended for further study.

At the output of the first cycle and the input to the U-Pu separation stage, the fission product gamma-ray background is low but the U/Pu ratio is still too high for absorption edge densitometry. The X-ray fluorescence spectrometer again is recommended for further study.

At the input to the third (plutonium) extraction cycle, most of the uranium and fission product gamma rays have been removed but the plutonium concentration is still quite low. An instrument is needed with good sensitivity. The X-ray fluorescence spectrometer again is recommended, but the K-edge densitometer could also be considered.

After the plutonium purification cycle, the output is considerably

more concentrated. And at the output of the evaporator, the concentration has risen to about 250 g/l. At these points, either the K-edge densitometer (developed under TASTEX T-G) or the passive gamma-ray spectrometer (developed under TASTEX T-H) should work well. Both instruments were optimized for about 250 g/l. For improved performance at lower concentrations the passive gamma-ray spectrometer could be modified easily by enlarging the sample volume.

Statistical Evaluation Procedures

Statistical evaluation procedures used in the study are essentially those developed at the Los Alamos National Laboratory. The complete computer package includes four statistical tests, a straightforward cumulative sum (CUMUF) test, a uniform diversion test based on the Kalman filter statistic, a variance test, and a two directional test based on two Kalman filter models operating in opposite directions. The purposes of these tests are as follows:

- (a) CUMUF - this statistic provides a relatively powerful test which is in general not dependent on an assumed diversion pattern,
- (b) uniform diversion - as the name implies, this test is more sensitive when the diverter follows the nominally optimum strategy of diverting a uniformly small quantity during each material balance period,
- (c) variance test - if a would be diverter attempts to defeat other statistical tests by diverting in a random manner, the observed variance of the MUF data will be significantly larger than the variance derived from the measurement uncertainty for each material balance. The variance test is designed to give an increased detection sensitivity against randomized diversions by detecting this increased variance in the data,
- (d) two-directional test - this test recognizes that a revised estimate of the inventory at any earlier point in time can be derived from a consideration of subsequent flow and inventory data. In borderline situations it is expected that a two-directional test would be more sensitive to possible abrupt diversions.

Although early feasibility studies using simulated data considered all four of these tests, most work has been with only the first two. It seems likely that in actual practice primary reliance will be on the CUMUF and uniform diversion tests, and that the other tests will be used only to

provide supplementary evidence, or to suggest the need for further investigation of possible borderline situations.

Modeling and Simulation Work

JAERI has developed and applied a basic computer simulation model for the PNC-Tokai plant. A number of simulation runs have been performed using this model, covering a wide range of fuel types (burn-up levels), operating conditions, and assumed diversion strategies. The simulations also included two levels of assumed measurement uncertainties, one based on current operating practices, and one based on assumed improvements which might be possible in the future.

Table E.2 summarizes the basic simulation runs and the results obtained. In general, when the assumed level of diversion was one standard deviation of the weekly material balance (or greater), protracted diversion was detected before the total diverted reached the 8 kgs goal. Abrupt diversion of 8 kgs Pu was detected in all cases. When the assumed level of diversion was the minimum necessary to accumulate 8 kgs Pu in one year, and the assumed mode of operation called for frequent system "rinse-outs" followed by changes in fuel types or burn-up levels, some difficulties were encountered. It is believed that these difficulties relate primarily to the unmeasured portion of the inventory, which was allowed to appear as MUF during the first material balance period after each rinse-out. Future studies should consider ways to include an estimate of this unmeasured inventory, presumably in the form of a constant, in order to improve detection sensitivity in borderline situations.

DESCRIPTION OF DEMONSTRATION AND TEST

Preliminary field test data was collected by PNC during two reprocessing campaigns in 1980. These campaigns, identified as the C-1 and C-2 campaigns, involved the recovery of 50 tons of spent fuel from a variety of both BWR and PWR reactors. A total of fifteen short term material balances were prepared, based on thirteen in-process inventories plus cleanout physical inventories at the start of the C-1 campaign, between the two campaigns and at the end of the C-2 campaign.

No unforeseen problems arose during the collection of the field test data. The time needed for an in-process inventory, exclusive of the time

required to analyze samples, is less than a half hour. A product rework tank, not included in the original feasibility study, may sometimes contain a significant quantity of plutonium, but its measurement using the same procedures as for the four buffer storage tanks creates no additional difficulty.

It was necessary to be more flexible than had been anticipated in the timing of the in-process physical inventories, because the product evaporator was not emptied on the anticipated 24 hour schedule. This led to material balance periods varying between six and nine days, or occasionally longer when the plant was in a rinse-out mode, but caused no other difficulties. As the plant moves closer to operation at its design capacity it is anticipated that this required flexibility will not affect operation of a near-real-time materials accountancy system.

During the early stage of the field test it was not always possible to complete data collection and evaluation within the specified schedule of two or three days after the in-process inventory. However, those problems have gradually been resolved, and current field test data are being made available in a timely manner.

TEST RESULTS AND EVALUATION

Evaluation of Preliminary Field Test Data

A CUMUF plot of the resulting MUF data is shown in Fig. E.2 and the associated alarm sequence chart is shown in Fig. E.3. (An estimated amount of Pu has been added to each of the in-process inventories, as an estimate of the unmeasured portion of the inventory. The accuracy of this estimate affects only the MUF during the first material balance period, and is of no consequence in the discussion that follows.)

The solid line indicates dynamic MUF data calculated under the assumption that the inventory hold-up in the mixer-settler systems had been kept constant. In the actual plant operation, it changed from time to time. In order to take these variation into consideration, inventories in all stages of the mixer-settler systems were estimated by SEPHIS code using actual operating data, and used to correct the original dynamic MUF data. These data are indicated for the C-1 campaign by the dotted line in Fig. E.2.

Fig. E.2 clearly shows that there is a measurement bias across the PNC-Tokai plant process MBA, resulting in an apparent net gain of

plutonium. The nature of this bias is not clearly shown in conventional materials accountancy data, and Fig. E.2 gives a dramatic picture of the power of the near-real-time accountancy concept.

An analysis of input minus output for the process MBA was performed for the C-1 campaign. (Such an analysis is simply a calculation of the apparent plutonium book inventory in the process MBA based on the difference between measured inputs and measured outputs.) This analysis, although it suggested qualitatively an ability to detect any diversion larger than about 1 kg Pu per week, did not reveal the measurement bias and resultant apparent gain in plutonium across the process MBA. Thus the conclusion is that, even for a relatively small facility such as PNC-Tokai, input-output analysis is not a sensitive measure for the detection of protracted diversion.

Estimation of Inventory Hold-up in Mixer-Settler Systems

The original proposal for near-real-time materials accountancy in the PNC-Tokai facility included an estimation of the plutonium inventory in the mixer-settler systems using a computer simulation model and measured aqueous feed rates and concentrations. Progress in this area has been slow. The problem is not critical to a demonstration of near-real-time materials accountancy in the PNC-Tokai facility because of the relatively small facility size. It will be a more important problem, however, in determining the ultimate detection sensitivity of the concept when applied to larger facilities.

The dynamic MUF data in Fig. E.2, for example, shows the effect of using a SEPHIS calculation to estimate the plutonium inventory in the mixer-settlers during the C-1 campaign. The apparent MUF loss during period four indicated by the solid line (uncorrected dynamic MUF data) led the sequential decision analysis to a conclusion of no apparent MUF pattern. The corrected dynamic MUF data indicated by a dotted line clearly shows that this apparent MUF loss was the result of an unusually high mixer-settler system inventory at that time.

It is now questioned by some experts working on solvent extraction system models whether SEPHIS, being an equilibrium state model, can always dependably estimate the actual inventory in a non-equilibrium system, even when that system is operating relatively smoothly at steady-state. A new code, PUBG, has been developed specifically for mixer-settler systems, and

a revised version was published in mid-1981.

The PUBG work has shown that the total Pu inventory, the only quantity of safeguards interest, is a sensitive function of the feed and waste concentrations. Since these are quantities which are already available, it is hoped that a simplified model can be developed along the lines of $H = AC_f + BC_w$, where H is the plutonium inventory, C_f and C_w are the aqueous feed and aqueous waste concentrations, respectively, and A and B are constants determined from PUBG modelling.

Verification for International Safeguards

Examination of the question of verification for international safeguards has led to several useful conclusions. First, it is concluded that the problem of rapid, timely verification against the gross falsifications necessary to conceal an assumed abrupt diversion can be separated from the problem of highly accurate verifications needed to detect possible small falsifications which might conceal an assumed protracted diversion. The former must be timely but need not be accurate, the latter must be accurate but need not be timely. There are no verifications which must be both.

Second, it is concluded that relatively little verification effort need be directed toward inventory data, first because the magnitude of the in-process physical inventory is relatively small, such that its falsification to conceal an assumed abrupt diversion would be difficult, and second because the frequent repetitions of the in-process inventory make even small falsifications unproductive.

Third, it is concluded that the assumed continuous presence of an inspector results in the availability of considerable collaborative data which can be used to provide approximate verifications.

The study of verification for IAEA safeguards has not yet progressed to the point where it is possible to specify a complete set of verification procedures. Some examples can be given, however. The input measurement, for example, can be roughly verified by two methods. One involves comparison of the total plutonium found on dissolution with the plutonium expected based on reactor calculations. Much has been written about the unreliability of the latter, and in terms of precise verifications reactor calculations probably are unreliable. From the actual data collected during the C-1/C-2 campaigns, however, the difference normally is less than

200 gms Pu, and the average difference tends reasonably well toward zero. If falsifications are limited to less than 200 gms Pu per batch, 40 batches, over a period of at least three weeks, must be falsified. Since the data should tend toward zero, any sequence of 30-40 batches in which the difference was consistently large would be cause for investigation and more careful verification. In the absence of such a consistent pattern, the inspector can assume that input measurements are not being grossly falsified, and can wait for the conventional chemical verification to confirm the absence of smaller falsifications.

A second verification of the input measurement can be obtained from a comparison of Pu/U ratios found with those expected based on reactor calculations. Again, the verification is not precise, but it is adequate to detect falsifications in the range of 150-200 gms Pu or more, thereby gaining time for the performance of more precise verifications.

The minimum falsification which extended over every flow batch during an entire year of operation at nominal capacity and would achieve a diversion of 8 kgs Pu, is about 10 grams. This is about 0.16-0.30% for a typical batch, depending on the type of batch. Since the assumption is that the falsification is repeated in every batch for an entire year, detection at this level may not be out of the question. Multiple period statistical techniques, in particular tests based on the Kalman filter statistic, should be able to contribute to an increased detection sensitivity in this range.

ASSESSMENT OF RESULTS

The feasibility study has shown that near-real-time materials accountancy for the PNC-Tokai reprocessing facility is technically feasible, and that indeed it would require no measurements not routinely performed for process control purposes. It has also shown that if the system is implemented using weekly in-process inventories of the four buffer storage tanks the detection sensitivity should meet all IAEA guidelines.

The field test data currently available, however, are not sufficient to permit any estimation of the ultimate detection sensitivity of n.r.t. accountancy for the PNC-Tokai facility, especially considering the existing measurement bias. There is a need to continue field testing.

RECOMMENDATIONS FOR FUTURE WORKDevelopment of Integrated Safeguards System

Most of the work to date has been related to the use of near-real-time materials accountancy in the process MBA. To be of maximum value for IAEA safeguards, this concept must be combined into an integrated safeguards system which considers all material balance areas, and which combines near-real-time materials accountancy with containment-surveillance measures in some optimum manner. Such a system has been prepared in conceptual outline; many details still require study and development.

In the spent fuel receiving and storage area the conceptual outline suggests that IAEA inspectors would observe and verify, on a 100% basis, all spent fuel receipts. Either photographic or video surveillance would be used to ensure that there were no undeclared receipts or shipments of spent fuel, and perhaps also to monitor the spent fuel storage area itself. Primary reliance for the latter, however, would be placed in a mini-computer X-Y crane position monitoring system. The mini-computer would store safeguards-relevant information related to stored spent fuel, and would record storage locations in terms of an X-Y grid of the entire area capable of being traversed by the spent fuel handling crane. When spent fuel was transferred to the mechanical cell for processing, the computer would note, from crane movements and from crane weight loads, the identity of the fuel transferred, thus eliminating the need for inspector observation and verification of these transfer activities. Such a computer monitor system does not now exist, and needs to be developed and studied.

In the process MBA primary reliance would be on the near-real-time materials accountancy system already developed. As a supportive system, a limited computer monitoring system would be developed. This computerized monitoring system, however, would not need to be nearly as extensive as some that have been suggested. This is because, although there are innumerable ways in which plutonium might conceivably be diverted from the process MBA, virtually all diversion paths necessarily affect either the volume in one of the four buffer storage tanks or some other critical parameter closely associated with those tanks. It is believed, subject to further development and study, that it would be extremely difficult to devise a diversion mechanism which did not directly or indirectly affect one of those tanks in some observable manner.

TASTEX task I has already developed a monitoring system for the product storage area, which system presumably would be incorporated into the proposed integrated safeguards system more or less intact. Since that system largely deals only with solution volumes, however, a system of near-real-time materials accountancy based on periodic chemical sampling and analysis of the storage tanks would also be necessary.

Development of Improved Model for Estimation of Inventory Holdup in Mixer-Settler Systems

As previously discussed, the validity of SEPHIS should be reviewed in comparison with PUBG using actual operating data, because SEPHIS assumes that contactors operate at mass transfer equilibrium. It therefore does not account for the effects of mass transfer rates, while PUBG does account for these effects. If the effects are significant, the difference in estimation of inventory may become a significant problem in determining the ultimate detection sensitivity of the proposed n.r.t. materials accountancy system.

It is expected that a simplified model to estimate the total Pu inventory in a mixer-settler system can be developed using aqueous feed and aqueous waste concentrations, and two constants which can be derived from PUBG modeling. This simplified model, if developed successfully, becomes a very useful and effective tool for the n.r.t. accountancy system.

Investigation of Source of Measurement Bias across the Process MBA

The results of analysis of field test data in the C-1 and C-2 campaigns clearly showed that there was a measurement bias across the process MBA. The source of this bias should be investigated as soon as possible in order to improve the reliability of the materials accountancy of the Tokai Plant.

CONCLUSIONS

The TASTEX task F work has shown that it might be feasible to apply near-real-time materials accountancy to the PNC-Tokai facility, that doing so could fulfill IAEA goals in terms of detection timeliness and sensitivity, and that by such a system the impact on normal facility

operations could be minimized. It has also shown that it should be possible to develop and implement inspection procedures which could verify the near-real-time accountancy data for IAEA safeguards purposes, and that it should be possible to incorporate the near-real-time accountancy system into an integrated safeguards system for the entire facility.

Continuing activities are necessary, and are planned, in a number of areas. Minor modifications still appear to be necessary in the sequential decision analysis used to evaluate near-real-time accountancy data, particularly to accommodate an inspector-supplied estimate of the unmeasured in-process inventory. Both the study of IAEA verification procedures and the definition of an integrated safeguards system are incomplete, and require further study. Field testing, needs to be continued as an aid in defining ultimate detection sensitivity.

Several problems have arisen in the course of the study which require further effort if near-real-time materials accountancy is to achieve its anticipated full potential. Specifically,

- (a) there is a need for an instrumental (NDA) measurement for input dissolver solutions,
- (b) there is a need to validate the PUBG model for solvent extraction system modeling, and to derive from it the simplified inventory estimation model needed for near-real-time accountancy and IAEA safeguards.

Table E.1 Measurement method for KMPs associated with " Ten Day Detection Time " model

KMP	Process Step	Method	No. of Analyses per Week	Time for Analysis	Estimated Accuracy*
Q-1	Input accountability tank	Isotope dilution mass spectroscopy (I.D.M.S.)	14	8 - 12 hrs	
D-1	Feed tank for 1st extraction cycle	I.D.M.S.	1	4 hrs	
D-2	Feed tank for 2nd extraction cycle	Titration	1	4 hrs	1 %
		X-ray fluorescence		1 - 2 hrs	
D-3	Feed tank for Pu-3rd extraction cycle	Titration	1	8 - 24 hrs	0.5 - 1.0 %
		X-ray fluorescence		1 - 2 hrs	
D-4	Pu evaporator feed vessel	Titration	1	8 hrs	0.5 - 1.0 %
		X-ray fluorescence or L-edge densitometry		1 - 2 hrs	
Q-9	Pu solution product	I.D.M.S.	7	8 - 12 hrs	0.5 - 1.0 %
		K-edge densitometry		1 hr	

* does not include error in volume measurement

Table E.2 Summary of basic Simulation Studies

Diversion Mode	Simulation Study	Average Diversion Rate in a DMBP (kg)	Total Diversion in a TMBP (kg)	N.R.T Material Accountancy			Traditional Material Accountancy		
				$\overline{\text{MUF}}_d$ (kg/DMBP)	$\overline{\sigma \text{MUF}}_d$ (kg/DMBP)	LEMUF = $2\overline{\sigma \text{MUF}}_d$ (kg/DMBP)	MUF (kg/TMBP)	σMUF (kg/TMBP)	LEMUF = $2\sigma \text{MUF}$ (kg/TMBP)
No Diversion	S.S.1-1	-	-	0.023	0.260	0.520	0.432	3.540	7.080
	1-2	-	-	0.064	0.340	0.680	1.154	4.539	9.078
	1-3	-	-	0.061	0.376	0.752	1.158	5.320	10.640
	1-4	-	-	0.045	0.303	0.606	0.855	4.196	8.392
	1-5	-	-	0.113	0.431	0.862	2.267	6.480	12.960
	1-6	-	-	0.108	0.517	1.034	2.167	7.617	15.234
	1-7	-	-	0.110	0.433	0.866	2.081	6.076	12.152
	1-8	-	-	0.088	0.421	0.842	1.498	5.264	10.528
	1-9	-	-	0.136	0.426	0.852	1.629	3.852	7.704
	1-10	-	-	0.097	0.404	0.808	1.164	3.445	6.890
	S.S.4	-	-	-	0.009	0.404	0.808	1.615	4.951
Uniform Diversion of 0.25 ~ 1.5 $\overline{\text{MUF}}_d$ per DMBP	S.S.1-1	0.250	4.742	0.304	0.259	0.518	5.778	3.516	7.032
	1-2	0.323	6.133	0.430	0.327	0.654	8.171	4.517	8.314
	1-3	0.360	7.205	0.468	0.368	0.736	9.358	5.299	10.598
	1-4	0.313	5.637	0.389	0.312	0.624	7.002	4.173	8.346
	1-5-1	0.462	8.780	0.537	0.451	0.902	10.197	6.452	12.904
	1-5-2	0.115	4.436	0.307	0.465	0.930	11.047	12.513	25.026
	1-6	0.517	10.332	0.598	0.515	1.030	11.963	7.599	15.198
	1-7	0.457	8.217	0.492	0.453	0.906	8.858	6.049	12.098
	1-8	0.444	7.096	0.570	0.430	0.860	9.117	5.236	10.472
	1-9	0.665	7.978	0.727	0.432	0.864	8.722	3.821	7.642
	1-10	0.661	7.274	0.733	0.421	0.842	8.068	3.422	6.844
S.S.4	0.478	8.119	0.533	0.396	0.792	9.053	4.928	9.856	
Uniform Diversion of 8 kgs per year	S.S.1-5-1	0.200	4.004	0.335	0.430	0.860	6.705	6.459	12.918
	1-7	0.211	4.012	0.304	0.431	0.862	5.779	6.064	12.128
	1-8	0.235	4.001	0.337	0.423	0.846	5.734	5.247	10.494
	1-9	0.223	2.672	0.294	0.435	0.870	3.523	3.843	7.686
	1-10	0.243	2.675	0.371	0.424	0.848	4.086	3.432	6.864
	S.S.4	0.239	4.062	0.372	0.417	0.834	5.392	4.945	9.890

DMBP : Dynamic Material Balance Period = 7 days

TMBP : Traditional Material Balance Period = 6 months for S.S.1-1 ~ S.S.1-8 and S.S.4
 4 months for S.S.1-9, S.S.1-10
 10 months for S.S.1-5-2

$\overline{\text{MUF}}_d$: Average MUF_d
 $\overline{\sigma \text{MUF}}_d$: Average σMUF_d

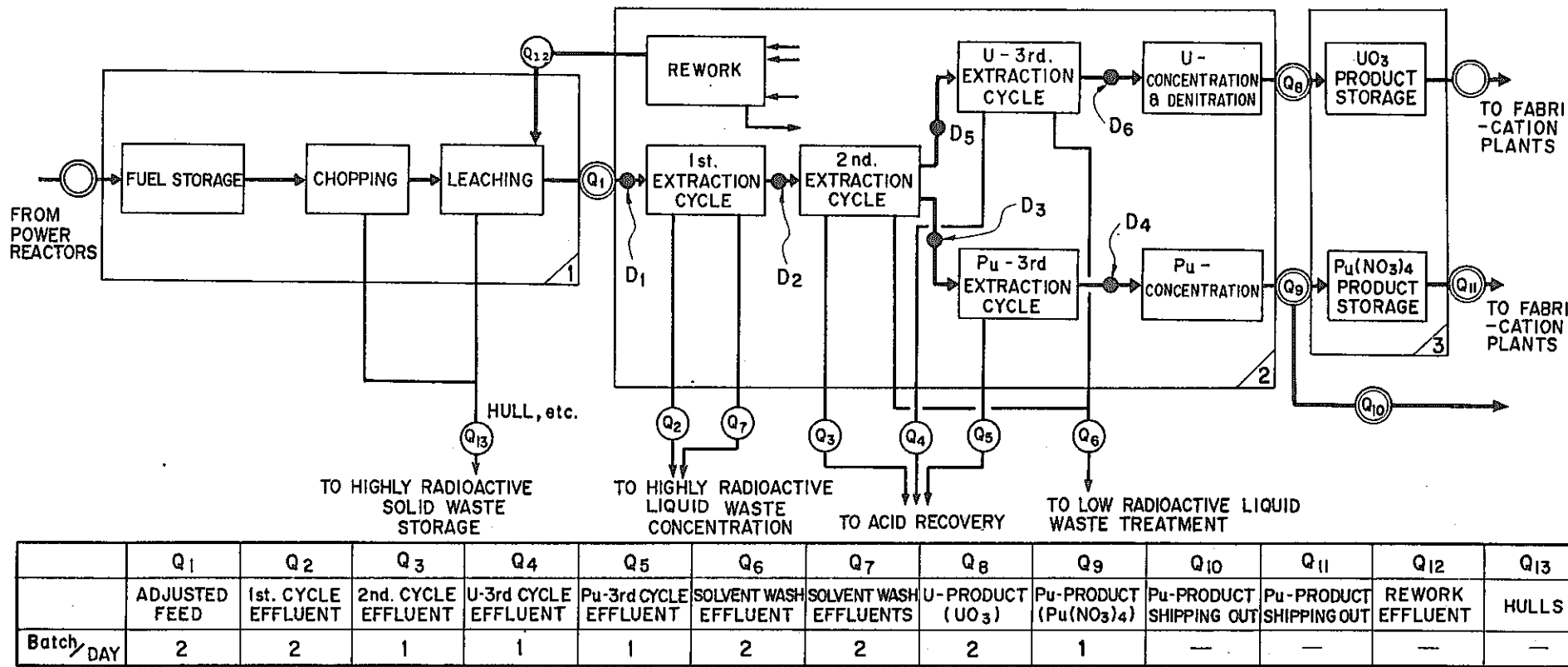

D₁ ~ D₆ = MEASUREMENT POINTS FOR IN-PROCESS INVENTORY

Material Balance Area 2 is defined as material balance area for the near-real-time material accountability.

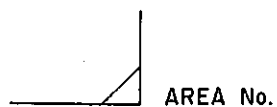

- — BUFFER VESSEL ... IN-PROCESS ACCOUNTABILITY POINTS
- — MAIN ACCOUNTABILITY POINT
- — OTHER ACCOUNTABILITY POINT

Fig. E.1 Schematic diagram of materials accounting

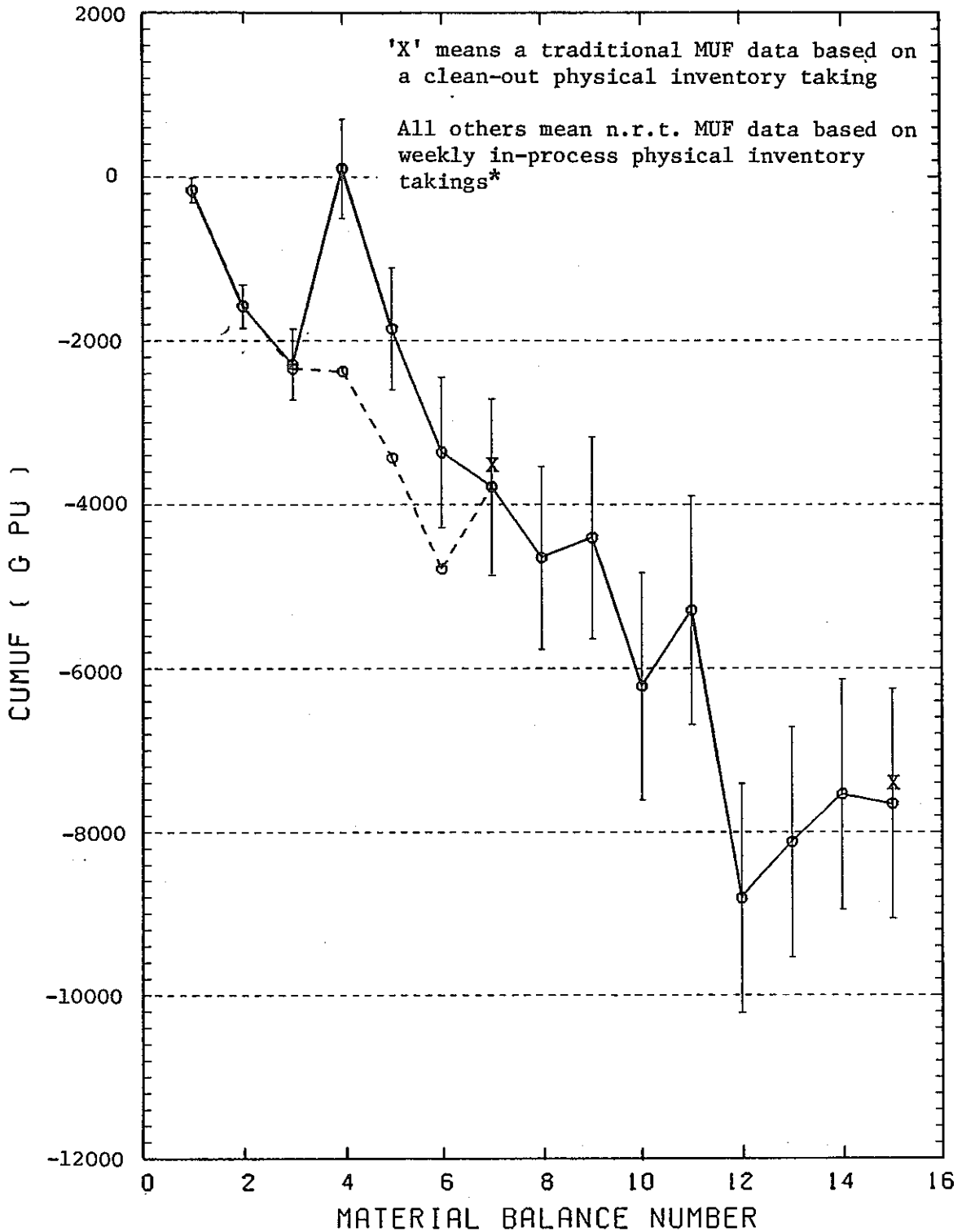
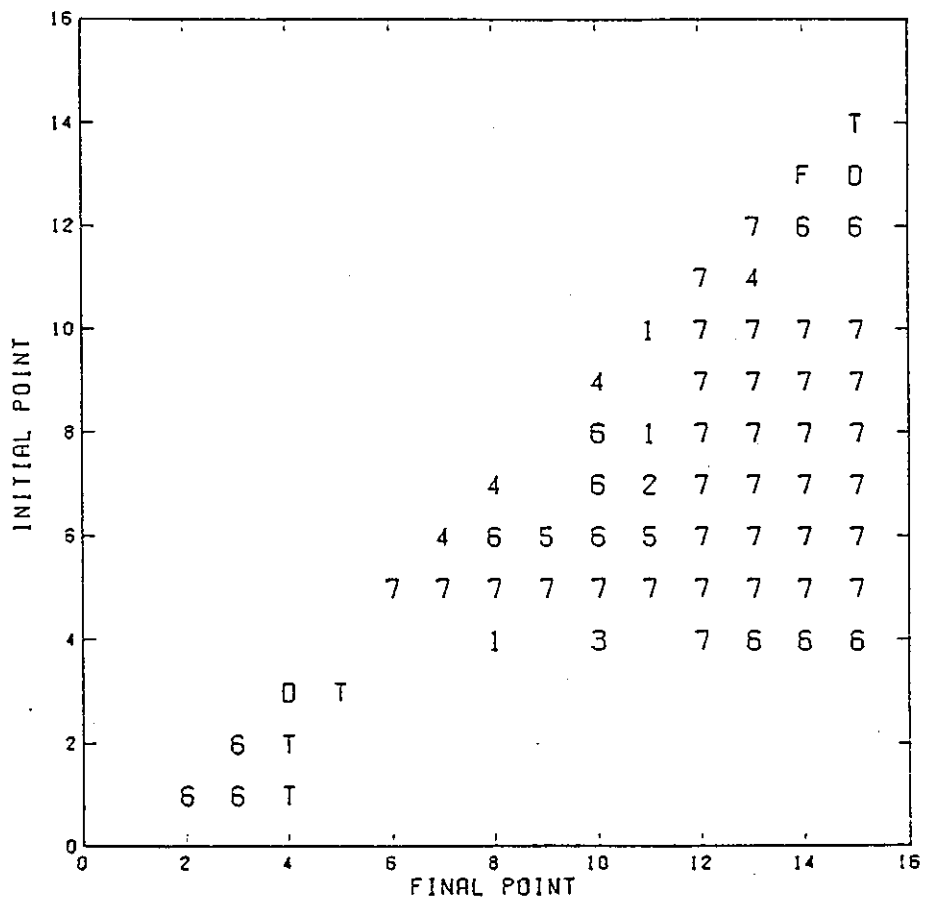

Fig. E.2 CUMUF data based on adjusted MUF_d data in C-1 and C-2 campaigns

* All MUF data on a solid line are adjusted to include an estimated unmeasured inventory. Only the first MUF is affected.

All MUF data on a dotted line are corrected for fluctuation of the inventory in the mixer-settler systems and adjusted to include an estimated unmeasured inventory other than that in the mixer-settler system.



Alarm Classification for Alarm - Sequence Chart

Classification (Plotting symbol) for gain, loss		false - alarm Probability
A	1	10^{-2} to 5×10^{-3}
B	2	5×10^{-3} to 10^{-3}
C	3	10^{-3} to 5×10^{-4}
D	4	5×10^{-4} to 10^{-4}
E	5	10^{-4} to 10^{-5}
F	6	10^{-5} to 10^{-8}
G	7	< 10^{-8}
T		~ 0.5

Fig. E.3 Alarm Sequence Chart for C-1 & C-2 Campaigns

1. INTRODUCTION

1.1 Background of the Study

In the Spring of 1978 the governments of Japan, the United States and France mutually agreed to pursue a program for the improvement of safeguards techniques as applied to spent fuel reprocessing plants, with emphasis on the applicability of these techniques to the Tokai facility. This joint program has been called by the acronym TASTEX for Tokai Advanced Safeguards Technology Exercise.

In the statement of cooperation, Japan, the United States and France pledged to keep the International Atomic Energy Agency fully informed of the progress of the research and testing performed; to solicit the advice of the Agency in insuring that the joint program was consonant with the Agency's safeguards objectives and would serve to augment the effectiveness of international safeguards; and to invite the Agency to participate in all phases of implementation of the program.

The TASTEX program included the following thirteen tasks;

- A) Evaluation of performance and application of surveillance devices in the spent fuel receiving areas,
- B) Collection and analysis of gamma spectra of irradiated fuel assemblies measured at storage pond,
- C) Demonstration of hull monitoring system,
- D) Demonstration of load cell techniques for measurement of solution weight in the accountability vessel,
- E) Demonstration of electromanometer for measurement of solution volume in the accountability vessel,
- F) Study of application of DYMAC (near-real-time materials accountancy) principles to safeguarding spent fuel reprocessing plants,
- G) K-edge densitometer for measuring plutonium product concentrations,
- H) High resolution gamma spectrometer for plutonium isotopic analysis,
- I) Monitoring the plutonium product area,
- J) Resin Bead sampling and analytical technique,
- K) Isotope safeguards techniques,
- L) Gravimetric method for input measurements,
- M) Tracer method for input measurements.

Among these thirteen tasks, Task-F, "Study of the application of DYMAC

Principles to Safeguarding Spent Fuel Reprocessing Plants," is pertinent to this report.

In the initial discussions as to how to proceed with Task F, concerns were expressed regarding the question of access, on the part of U.S. engineers, to design and flowsheet information regarding the Tokai facility. It was recognized that such a feasibility study had been part of a joint research agreement between PNC and the IAEA prior to organization of the TASTEX program, and that U.S. assistance would be of value, in particular since the original DYMAC was of U.S. origin. On the other hand French representatives emphasized that the DYMAC concept was a facility operator controlled system of value only for internal process control, and not an international safeguards system.

It was agreed that the United States would provide a one or two week briefing at the Los Alamos Scientific Laboratory for Japanese engineers, and that decisions regarding further U.S. participation in task F would be deferred until after the LASL seminar had been held. It was also agreed that the primary emphasis in the task would be on a "feasibility study" of the possible application of DYMAC (near-real-time materials accountancy) principles to safeguards for reprocessing plants of 300 t/a or smaller capacity.

As will be seen, the model actually developed and studied bears little resemblance to the DYMAC model developed at LASL. As a result, although U.S. engineers provided significant suggestions and comments throughout the study, their role was largely a consulting role, and there was little need to consider specific questions of access to unpublished design or operating data.

1.2 Purpose and Scope of the Study

As a beginning statement, it is assumed that the application of near-real-time materials accountancy to reprocessing facilities, under the assumption that the facility is still in the design stage and the material control experts are allowed to influence that design, is feasible. In that broad sense, neither Task-F of the TASTEX program nor this report are necessary. Several more limited questions, however, do require study, and it is to these limited questions that this report is directed.

First, there are at least three reprocessing facilities either currently operating under IAEA safeguards or constructed and planned for

future operation, and it is not necessarily true that an effective near-real-time materials accountancy system can be back-fitted into those facilities at an acceptable cost. Second, at the time this study was initiated, the only existing study of the effectiveness of near-real-time materials accountancy for reprocessing facilities assumed a large 1500 t/a facility and a safeguards objective measured in hours. There had been no study of effectiveness for current facilities (300 t/a or smaller), nor had there been any published study of system designs based on assumed safeguards objectives in the range of seven to ten days. Third, there has to date been little work on the important question of the verification of dynamically prepared material balances on the part of international safeguards inspectors.

Thus the purpose of this report may be stated as being a study of the feasibility of the application of the basic concepts of near-real-time materials accountancy to existing small (under 300 t/a) spent fuel reprocessing facilities, using the facility at TOKAI as a model. The basic concept roughly corresponds to a detection time of 10 days, and the model is sometimes called the "ten day detection time model". For this case the capability of the model facility as it exists is examined.

No a priori definition of a quantitative safeguards goal is made; rather, the study attempts to define the effectiveness which could be achieved. The framework for international safeguards criteria and preliminary values of external criteria as proposed by the IAEA (1) are shown in section 1.4.

Two major areas have been considered only to a very limited extent, and remain the subject of possible future work. One is the combination, or integration, of near-real-time materials accountancy with other safeguards measures, notably those developed under other TASTEX projects, into a complete advanced safeguards approach for reprocessing facilities. The other is the verification of n.r.t. accountancy data so that it can be used for IAEA safeguards. Chapter 7 discusses this subject briefly; considerable work remains to be done.

1.3 Progress of the Study

In July, 1978, four people from PNC and JAERI visited the Los Alamos Scientific Laboratory (LASL present Los Alamos National Laboratory (LANL)) for the purpose of reviewing the work being done at that facility related

dynamic material control. There was also a review and discussion of the modeling techniques being developed at LASL for evaluating the effectiveness of proposed material control systems for hypothetical model facilities.

In August, 1978, JAERI invited J. E. Lovett, System Studies Section, Department of Safeguards, IAEA, to Japan for consultations on the feasibility of applying the basic concepts of near-real-time materials accountancy to reprocessing facilities. This was followed, in October 1978 by three way discussions in Vienna during which agreement was reached as to the specific tasks to be undertaken by each of the participating groups (LASL, IAEA, PNC and JAERI).

Two reports (9,10) of this study made by JAERI in the first year were submitted to PNC on April, 1979, and the one of those (9) was distributed to the relevant parties through PNC.

A LASL Report (LA-8070-MS draft) on Task-F was received in May, 1979, and reviewed by PNC/JAERI workshops held before a LASL workshop in July 1979. The workshop was held at LASL on 23-25 July 1979, at which time all aspects of the feasibility study were discussed, with particular attention to the separate reports prepared by Ikawa (9) and Lowry and Augustson (11).

One of the major topics at the LASL workshop was the question of field testing, and this topic was further explored by Mr. Lovett who was again invited by JAERI to Japan during early August 1979 for further consultations.

Mr. Lovett outlined a possible field test during his stay in Tokai, and presented it to the workshop held at PNC to discuss the technical feasibility of such a field test. The best time for such a field test was expected to appear in the early Spring of 1980, when PNC would hope to begin an 80 ton reprocessing campaigns.

A general meeting on the Task-F was held at JAERI Headquarters in Tokyo on August 7, 1979.

Preliminary studies up to this point suggested the need for a better mathematical model for estimating the plutonium inventory in solvent extraction contactors. Since the PNC-Tokai facility uses mixer-settlers and includes sampling capabilities at critical stages, LASL experts suggested extension of the Task F effort to include a development of a better solvent extraction system model. In view of continued questions concerning access to sensitive information and compatibility of near-real-time materials

accountancy with international safeguards agreements, neither the field test nor the solvent extraction system study were adopted during the September 1979 meeting of the TASTEX Steering Committee. Implementation of the field test was later agreed during the February 1980 meeting of the TASTEX Steering Committee, and data collection began in April 1980. Data collected through the end of 1980 are discussed in this report.

In January, 1981, JAERI invited Mr. J. E. Lovett, and Mr. D. D. Cobb (LASL) to Japan to participate in a joint workshop among PNC, LASL, IAEA and JAERI. The results of implementation of the field test, U.S. work related to an improved method for mixer-settler inventory estimation, and development of an advanced safeguards approach were the major topics discussed.

1.4 Goal Quantities and Timeliness Criteria

In 1975 the IAEA proposed a series of safeguards goals based on international standards of measurement. For plutonium it was assumed that the measurement technology then available would permit closing a material balance for a reprocessing facility within a standard deviation of about 1 %. The essence of the proposal was to use these standards, coupled with physical inventories taken up to four times per year for larger facilities, as a basis for planning inspections. These goals are shown in Table 1.1.

These proposed goals received very little support from the Member States, and in 1976 and 1977 there were many discussions concerning what the Agency's safeguards goals should be. In February 1978 the Standing Advisory Group on Safeguards Implementation discussed, and the IAEA adopted, a considerably more stringent set of guidelines based generally on fast critical mass calculations and estimations of the time required to convert a given material form into a fabricated metal shape(1). A paraphrased version of the guidelines adopted for plutonium is as follows:

- (1) for spent fuel, assurance that the diversion of sufficient fuel assemblies or fuel pins to permit the recovery of 8 kgs total plutonium would have a high probability of being detected within a period of one to three months;
- (2) for separated Plutonium, assurance that the "abrupt" diversion of 8 kgs Pu at one time, or over a short period of time, would have a high probability of being detected within one to three weeks; and
- (3) also for separated plutonium, assurance that the "protracted"

diversion of separated plutonium at an assumed minimum rate of 8 kgs per year would have a high probability of being detected before the total diverted equalled or exceeded 8 kgs Pu.

Table 1.1 Expected Accuracy (Standard Deviation) of a Material Balance and Verification Accuracy Goals expressed as a Percent of Inventory or Throughput.

Reprocessing Facility	Expected Accuracy of σ_{MUF}	Facility Detection Goal $\alpha = \beta = 0.05$	Inspection Detection Goal* $\alpha = \beta = 0.05$
Uranium	0.8	2.6	4.0
Plutonium	1.0	3.3	5.0

* includes inspector measurement errors

2. DEFINITION AND DESCRIPTION OF THE BASIC CONCEPT OF
NEAR-REAL-TIME MATERIALS ACCOUNTANCY

2.1 General

The conventional material measurement and accounting system has in general three major tasks:

- (1) Data collection including measurements,
- (2) Data analysis for diversion detection, and
- (3) Data dissemination or reporting.

These tasks rely havily on material balance accounting following periodic shutdown, cleanout, and physical inventory takings. The conventional material balance associated with this system is drawn around the entire plant or a major portion of the process, and is formed by the following equation.

$$BI + R - S - MD - EI = MUF \quad (2.1)$$

where

- BI = Beginning Inventory
- R = Receipts, nuclear production, etc.
- S = Shipments, nuclear loss, etc.
- MD = Measured discards, and
- EI = Ending Inventory.

This equation is solved by measuring all receipts, shipments, and discards for some significant period of time, typically 3 to 12 months.

Although conventional material balance accounting is essential to nuclear material safeguards it has inherent limitations in sensitivity and timeliness, for which relatively strict international safeguards criteria are presented, as described in Section 1. The first limitation results from measurement uncertainties and the second limitation results from frequency of physical inventory takings for conventional material accounting. For example, in case of the model plant, σ_{MUF} for the 6-months material balance of PWR campaign is estimated as follows (Measurement accuracies shown in Table 5.4 are assumed);

when weekly recalibrations were assumed,

$$\sigma_{MUF} = 5.9 \text{ kg Pu} = 0.78 \% \text{ of feed,}$$

when monthly recalibrations were assumed,

$$\sigma_{MUF} = 6.4 \text{ kg Pu} = 0.84 \% \text{ of feed,}$$

and when no recalibrations were assumed,

$$\sigma_{MUF} = 8.7 \text{ kg Pu} = 1.1 \% \text{ of feed.}$$

These figures should be compared with the values of significant quantity (8 kg Pu) and international standard of measurement accuracy in Table 1.1. Using these quantities, facility and inspection detection goals are estimated as follows ($\alpha = \beta = 5\%$);

σ_{MUF}	Facility Goal	Inspection Goal
0.78% 5.9kg Pu	19.5kg Pu	29.5kg Pu
0.84% 6.4kg Pu	21.1kg Pu	32.0kg Pu
1.1 % 8.7kg Pu	28.7kg Pu	43.5kg Pu

These quantities are too large in comparison with the significant quantity of "direct-use" plutonium (8 kg), and also these amounts could be detected, in the worst case, only after 6 months from the occurrence of diversion. Such a detection is, in any case, not timely.

2.2 Basic Requirements

The model reprocessing plant is a small scale plant of about 210 ton/a. Based on a preliminary study relating to the applicability of sub-area accounting to the model plant, the formal process material balance area (MBA2) was not further sub-divided. The MBA thus covers the entire process containing plutonium, i.e., from the input accountability vessel to the plutonium-product reception vessel. The frequency of n.r.t. material balance closing is taken to be weekly, i.e., the n.r.t. material balance equation shown below is solved weekly using estimates of the in-process physical inventory :

$$\begin{aligned} & \text{N.R.T. Material Balance (NRTMB)} \\ & = MUF_d = BI_d + I_d - P_d - W_d - EI_d \dots \dots \dots (2.2) \end{aligned}$$

where

BI_d = measured beginning inventory, identical to the measured ending inventory from the preceding n.r.t. material balance period,

I_d = measured input dissolver batches during the n.r.t. material balance period,

P_d = measured product batches during the n.r.t. material balance period,

W_d = measured waste discard batches during the n.r.t. material balance period,

EI_d = measured ending inventory at the end of the n.r.t. material balance period, and

MUF_d = n.r.t. material unaccounted for, including variation in the unmeasured portion of the in-process inventory.

The subscript d is used to make it clear that some or all of the data used in the n.r.t. material balance was determined using procedures designed to give rapid but not necessarily highly precise results. In particular, I_d and P_d measurements would be subject to revision when more precise wet chemical analyses became available, and it is these latter data, not the rapid (e.g., NDA or process control) measurements used for n.r.t. materials accountancy, which would be entered in the formal materials accountancy record and report system.

It is also important to recognize that EI_d does not include the entire physical inventory. The success of the method requires that it include all significant inventory quantities, but several minor process holdup quantities, and very likely the more significant extraction equipment, are knowingly omitted. Thus during initial startup operations MUF_d includes this unmeasured in-process inventory. Under steady-state conditions, which are a pre-requisite to successful n.r.t. materials accountancy, only the fluctuations in this in-process inventory appear in MUF_d .

Analysis of materials accounting data for possible diversion is one of the major functions of the material measurement and accountancy system. Two basic patterns of diversion are assumed : one is short-term and the other is long-term.

Decision analysis, which combines techniques from estimation theory and system analysis is well suited for statistical treatment of the imperfect dynamic material-balance data that become available sequentially in time.

Its primary goals are:

- (1) detection of the event(s) that nuclear material has been diverted,
- (2) estimation of the amount(s) diverted, and
- (3) determination of the significance of the estimates.

In broad term, implementation of this system involves only three basic requirements. The first, and most important, is the ability to measure all inputs, all outputs, and at least the majority of the physical inventory

without significantly affecting normal plant operations. The second requirement is the ability to perform the large number of bulk and analytical measurements implied by the first requirement at a reasonable cost and with sufficient speed to satisfy the requirements of timeliness. The third requirement, almost trivial in terms of modern computer technology, is the capability to handle the volume of accountancy data generated, and to perform the statistical evaluations required, within the defined limitations of timeliness.

2.3 Condition for Backfitting

In general, the objective of dynamic materials control is to use a combination of computer data processing, in, on, or at-line non-destructive measurement equipment, improved facility design, and advanced statistical techniques to prepare and evaluate a large number of material balances or modified material balances, each covering both a small portion of a large bulk processing facility and a short period of time. In the case of existing facilities, however, adoption of some of these elements may not be possible without significant modifications of the plant itself. It is, of course, desirable to limit such a modification as small as possible. From this point of view and based upon the preliminary study on the plant characteristics of the reference model plant, the following were taken into account as elements to construct a possible dynamic materials control:

- (1) The in-process physical inventory should be taken weekly during plant operation and the analysis and evaluation should be made within three days after the inventory cutoff point.
- (2) Existing plant instrumentations should be used whenever they could satisfy the minimum requirement for timeliness and sensitivity.
- (3) Wet chemical analytical techniques being used in the model plant should be chosen so long as the laboratory is able to produce results within three days after sample taking.
- (4) The most effective statistical data analysis techniques combined with supportive computer technology should be fully utilized.

3. THE MODEL PLANT

3.1 Plant Characteristics

The model plant for this study is based on the PNC Reprocessing plant at Tokai, Japan, and information on Tokai plant described in this section is obtained from PNC (7). The plant is designed to process spent fuel of an average burnup not exceeding 28000 MWD/ton HM (HM = Heavy Metal) (Maximum : 35000 MWD/ton HM) at a processing rate up to 0.7 ton(U)/day.

The model plant uses the Purex recovery process with a mechanical chop-leach headend and mixer-settler contactors. Final products are uranium trioxide powder and concentrated plutonium nitrate solution.

3.2 Process Description

The general scheme of chemical treatment in the model plant is shown in Fig. 3.1, and a block diagram is shown in Fig. 3.2. The plant consists of the following main areas and processes:

Receiving and storage of irradiated fuels

Chop and leach

- . chopping
- . leaching and clarification

Chemical separation and purification processes

- . feed adjustment and input accounting
- . co-decontamination process (1st extraction cycle)
- . partition process (2nd extraction cycle)
- . uranium purification process (U-3rd extraction cycle)
- . uranium concentration and denitration process
- . plutonium purification process (Pu-3rd extraction cycle)
- . plutonium concentration process
- . rework process

Uranium product storage

Plutonium product storage

Liquid waste treatment and storage

- . highly radioactive liquid waste (HAW) concentration
- . concentrated HAW storage
- . acid recovery process including medium-level radioactive

liquid waste treatment

- . off-gas treatment
- . low-level radioactive liquid waste (LAW) concentration process
- . concentrated LAW storage
- . very low-level radioactive liquid waste (VLAW) chemical precipitation and separation process
- . VLAW sludge storage

Solid waste treatment process and storage

- . highly radioactive solid waste treatment
- . low radioactive solid waste treatment and storage

Analytical laboratory

3.2.1 Receiving and Storage

Spent fuel assemblies are received at the plant spent fuel receiving bay in shielded casks. The cask is transferred to the cask-unloading pond, placed on its bottom and opened for fuel removal. The fuel assemblies are transferred to a fuel-storage pond to await reprocessing. Usually an assembly remains in the fuel-storage pond for at least 180 days for additional decay and cooling.

3.2.2 Chop and Leach Area

Fuel assemblies are remotely transferred from the fuel-storage pond to the feed mechanism of a mechanical shear, and chopped into small pieces (about 1 ~ 2 inches long). The chopped pieces are fed to one of two dissolvers which contain hot HNO_3 , and leached with HNO_3 . Two BWR fuel assemblies make up one dissolver batch, while one PWR fuel assembly makes up one dissolver batch. After dissolution the solution is adjusted to some specified values in HNO_3 and uranium concentration. The adjusted solution is transferred to the accountability vessel.

Leached hulls and other solid waste are removed to the highly radioactive solid-waste storage after monitoring.

3.2.3 Chemical Separation and Purification Process

In the accountability vessel the dissolver solution is sampled and its

volume and density are measured after final acid adjustment. The measured solution is fed to the solvent extraction process, in which the recovery and purification of uranium and plutonium are carried out using conventional Purex technology with mixer-settler contactors. A standard flowsheet for co-decontamination, partition, and purification of uranium and plutonium is shown in Fig. 3.3 and Fig. 3.4, respectively.

The adjusted solution is decontaminated, i.e., uranium and plutonium are separated from the bulk of the fission products in the first extraction cycle. In the partition cycle, uranium and plutonium are extracted from HNO_3 . After partitioning, uranium and plutonium are, respectively, purified in individual purification cycles.

The purified uranyl nitrate solution is concentrated by evaporation and converted into uranium trioxide powder. The plutonium nitrate solution is concentrated up to 250 g/l by evaporation.

3.2.4 Uranium Product Storage

Uranium trioxide powder is transferred to a separate conversion/fabrication facility, or is stored in the uranium product storage area.

3.2.5 Plutonium Product Storage

The product plutonium nitrate solution, $\text{Pu}(\text{NO}_3)_4$, is sampled, analyzed, and then transferred to storage tanks, and stored until it is transferred to a separate conversion facility.

Fuel fed to the chop and leach area goes through the entire cycle within 3 - 4 days if the plant is operating normally.

3.3 Material Flow and Holdup

The primary material flow and process equipment in the model plant are shown in Figs. 3.1, and 3.2. A standard flowsheet of the model reprocessing plant is shown in Figs. 3.3 and 3.4, for co-decontamination, partition and purification processes of uranium and plutonium, respectively.

Fig. 3.5 shows a computer simulation model for the material flow, in which the Process Unit Numbers (in parentheses) defined as indexes to specific locations in the computer model plant are indicated. Names of processes, tanks and flows are indicated with their corresponding Process

Unit Numbers in Table 3.1.

Plutonium and uranium inventories in process equipment vary depending upon operating conditions, e.g., type of dissolved spent fuel assembly, burnup of the fuel assembly, mixer-settler operating parameters, etc. The holdup as a function of some of these parameters has been modeled in a flow-simulation code DYSAS-R (Dynamic Safeguards Simulation Code for Reprocessing facility) using the SEPHISJ code (JAERI version of SEPHIS(8)).

Significant holdup occurs in the fuel dissolution, feed preparation and evaporation areas. Potential variations of these holdups are estimated for normal operating conditions of five-months-continuous running operation without any flushing out. The result for plutonium is shown in Table 3.2.

3.4 Materials Accountancy Measurements

3.4.1 Material Balance Areas and Measurement Points for Materials Accountancy

A schematic diagram for materials accountancy is shown in Fig. 3.6, in which three material balance areas (MBAs) are indicated. These are formal MBAs, and are used to draw conventional material balances after clean-out physical inventory takings, in accordance with the Facility Attachment to the Agreement concluded between Japan and IAEA.

For the near-real-time materials accountancy system (proposed in section 4), no additional definition of MBAs is necessary, but MBA-2 is identified as an n.r.t. material balance area, where an additional six measurement points are assigned for in-process physical inventories. These points are indicated by D_i 's in Fig. 3.6.

In order to use near-real-time materials accountancy as supportive measures for conventional materials accountancy in this model plant, the thirteen formal accounting points and six additional n.r.t. accounting points shown below are required.

- (1) Input measurement point Q_1
- (2) Uranium product measurement point Q_8
- (3) Plutonium product measurement point Q_9
- (4) 1st cycle effluent exit point Q_2
- (5) 2nd cycle effluent exit point Q_3
- (6) U-3rd cycle effluent exit point Q_4
- (7) Pu-3rd cycle effluent exit point Q_5

- (8) 1st cycle solvent wash effluent exit point Q₇
 (9) 2nd and 3rd cycles solvent wash effluent exit point Q₆
 (10) Plutonium product shipping out point (direct) Q₁₀
 (11) Plutonium product shipping out point (after storing) Q₁₁
 (12) Rework effluent measurement point Q₁₂
 (13) Hulls monitoring point Q₁₃
 (14) In-process inventory measurement point for feeding vessel :
 (Process Unit No. 4) D₁
 (15) In-process physical inventory measurement point for buffer
 vessel for 2nd Extraction cycle :
 (Process Unit No. 8) D₂
 (16) In-process physical inventory measurement point for buffer
 vessel for Pu 3rd Extraction cycle :
 (Process Unit No. 12) D₃
 (17) In-process physical inventory measurement point for buffer
 vessel for Pu concentration :
 (Process Unit No. 16) D₄
 (D₅ and D₆ are the points in uranium purification process)

3.4.2 Measurement methods

Measurement methods for the accountability purpose, including volume measurement, weighing, analysis and sampling are shown in Table 3.3.

(1) Input measurement

A conventional volume times concentration method is used for the input measurement. The measurement system is shown in Fig. 3.7. Level and density measurements are performed using 100 inch water manometers. Before the plant start-up, frequent calibrations were carried out under carefully controlled conditions to estimate the measurement accuracies. These calibrations were carried out by observing the consistency between the amount of weighed water and the pressure indication on a precision manometer.

The sampling system of the input accountability vessel is shown in Fig. 3.8. Before the plant start-up, experiments were carried out in order to establish sampling conditions which could produce representative samples. Based on these experiments, the sampling error was also estimated.

Isotope dilution mass spectrometry is used for the determination of

uranium and plutonium concentration in the solution. During plant operation strict quality control measures are applied to maintain good analytical performance.

(2) Plutonium product measurement

Again a conventional volume times concentration method is used. The volume measurement and sampling system for plutonium product are shown in Fig. 3.9. Calibration procedures similar to those for the input accountability vessel were chosen.

Before shipment, the volume of the Pu product solution is measured again by a constant-volume measuring pot. If the product is loaded out after storing, the solution is homogenized and the concentration is redetermined.

(3) Uranium product measurement

A weight times concentration method is applied for uranium product measurement. The weighing and sampling system of the measurement point is shown in Fig. 3.10.

(4) Waste measurement

Accuracies of waste measurements can be regarded as minor contributors to the total estimation error of MUF since the plant operator generally endeavors to reduce the rate of nuclear material loss to less than one or two percent of the input.

Liquid waste measurement

For the volume measurement, a dip tube recorder system is used. In particular, a proportional flow measurement system is used to measure the volume of effluents from 2nd extraction cycle, U-3rd extraction cycle and Pu-3rd extraction cycle, since this system does not need any large accountability vessel.

Concerning the analysis of nuclear material concentration, conventional methods are used as presented in Tables 3.3. Representative samples can be obtained by thorough mixing of the waste solution in the accounta-

bility vessels or by using proportional flow measurement devices.

Solid waste measurement

Solid waste may contain fissionable materials. The hulls of leached fuel elements are considered to be the major component in the solid waste measurement, although content of fissionable materials is very low, i.e., less than 0.3 % of the input.

Several approaches to monitor the quantity of the material remaining in hulls exist. One is to take representative samples and measure the material content by using a chemical technique. A second is to measure the gross weight of hulls with remaining materials and to compare the result with a known standard value. A third is the use of some in-line technique which may be favorable for the simplification of monitoring. Provision is foreseen to install a hull monitor utilizing a neutron activation technique. Installation of such a equipment was investigated by the TASTEX Task-C.

The existing hull-monitoring system is a UK-Hull Monitor based on measurement of fission product Pr-144 gamma radiation.

(5) In-process inventory measurement

In-process inventories consist of materials contained in process vessels, such as feeding vessels and receiving vessels, and materials contained in process equipments such as mixer-settler contactors and evaporators. All these vessels are equipped with a dip tube recorder system for volume measurement, plus mixing and sampling devices, and therefore it is possible to measure the quantity of the material contained.

Quantities of plutonium contained in these vessels are estimated by computer simulation for normal operating conditions, and are shown in Table 3.2. In general, process equipment and pots have no specific measurement capabilities. The approximate quantity of material contained in this process equipment is estimated by assuming normal conditions. The results of estimate by simulation code are also shown in Table 3.2.

The accountability in rework system is not discussed here since material flow for the rework process is assumed to be normally limited within a single MBA, e.g., MBA-2.

Table 3.1 Process Unit No. and Corresponding Name of Process Unit

Process Unit No.	Name of process unit	Process Unit No.	Name of process unit
(1)	Dissolver	115	Uranyl-nitrate
(2)	Buffer vessel	116	Adjusting solution
(3)	Adjusting vessel	117	Adjusting solution
(4)	Feeding vessel	201	Adjusting feed
(5)	Extraction-I	202	Solvent D37 flow
(6)	Extraction-II	203	Scrub flow
(7)	Adjusting vessel	204	Waste
(8)	Buffer vessel	205	Loaded solvent
(9)	Extraction-III	206	Solvent flow
(10)	Extraction-IV	207	Pu-strip
(11)	Adjusting vessel	208	Loaded solvent
(12)	Buffer vessel	209	U-strip
(13)	Oxidation column	210	Degraded solvent
(14)	Extraction-VIII	211	U-nitrated feed
(15)	Extraction-Ix	301	Pu-solution
(16)	Buffer vessel	302	HNO ₃ feed
(17)	Evaporator	303	Adjusting solution
(18)	Reception vessel	304	Adjusting solution
(20)	Extraction-V	305	Solvent flow
Fuel	Fuel storage	306	Solvent flow
Hull	Hull storage	307	Scrub flow
Pu(NO ₃) ₄	Pu(NO ₃) ₄ storage	308	Waste flow
101	Chopped spent fuel	309	Loaded solvent
102	Hull flow	310	Pu-strip acid flow
103	Dissolution solution	311	Solvent D37 flow
104	Adjusting solution	312	Solvent flow
105	Dissolution solution	313	Pu-nitrate flow
106	Adjusting solution	314	Pu-nitrate flow
107	Adjusting solution	315	Pu-nitrate flow
108	Adjusted feed	316	Pu-nitrate flow
109	Scrub feed	Q1	Meas.point
110	Solvent flow	Q2	Meas.point
111	Ha waste	Q3	Meas.point
112	Loaded solvent	Q5	Meas.point
113	Strip flow	Q7	Meas.point
114	Solvent	Q9	Meas.point

Table 3.2 Potential variations of Pu-holdups induced by fluctuations in characteristics of input fuel assemblies (unit:kg)

	BWR FUEL			PWR FUEL		
	BURNUP MWD/T			BURNUP MWD/T		
Process Unit No.	10,000	15,000	20,000	10,000	20,000	27,500
1	1.652	2.146	2.507	1.971	3.049	3.613
2	1.667	2.105	0.369	1.981	3.048	3.542
3	1.651	2.153	2.130	1.917	3.035	3.598
4	1.198	1.569	2.856	1.334	2.304	2.481
5	0.328	0.423	0.500	0.389	0.608	0.720
6	0.048	0.062	0.074	0.057	0.089	0.106
7	0.019	0.024	0.029	0.022	0.035	0.042
8	0.469	0.818	0.954	0.773	1.234	1.330
9	0.241	0.313	0.368	0.285	0.445	0.528
10	0.163	0.211	0.248	0.192	0.299	0.355
11	0.058	0.075	0.089	0.069	0.108	0.128
12	0.465	0.448	0.614	0.554	0.796	0.950
13	0.071	0.093	0.108	0.085	0.132	0.158
14	0.232	0.300	0.351	0.274	0.428	0.511
15	0.135	0.175	0.203	0.158	0.248	0.298
16	0.332	0.436	0.525	0.580	0.612	1.083
17	8.184	5.470	4.102	0.606	8.226	1.416
18	0.012	0.024	0.024	0.029	0.010	0.006
19	-	-	-	-	-	-
20	0.0	0.0	0.0	0.0	0.0	0.0

Table 3.3 Measurement methods for main KMPs.

KMP	Measurement point	Chemical analysis		Sampling	Volume or weight measurement
		Uranium	Plutonium		
FKMP-3	Input accountability vessel	Isotopic dilution -Mass spectrometry	Isotopic dilution -Mass spectrometry	Circulation using air lift and vacuum line	Pneumatic bubble system using dip tube
FKMP-5	Waste solution	Solvent-extraction -DBM spectrophotometry	Solvent-extraction - α counting	Circulation using air lift and vacuum line	Pneumatic bubble system using dip tube
FKMP-8,9	UO ₃ product	K ₂ Cr ₂ O ₇ titration	-	Propositional sampler	Weighing by a large scale
	Plutonium product accountability vessel	-	Ce(SO ₄) ₂ titration	Using vacuum	Pneumatic bubble system using diptube
IKMP	In-process inventory vessels	Case by case, methods same as FKMPs	Case by case, methods same as FKMPs	Case by case, methods same as FKMPs	Case by case, methods same as FKMPs

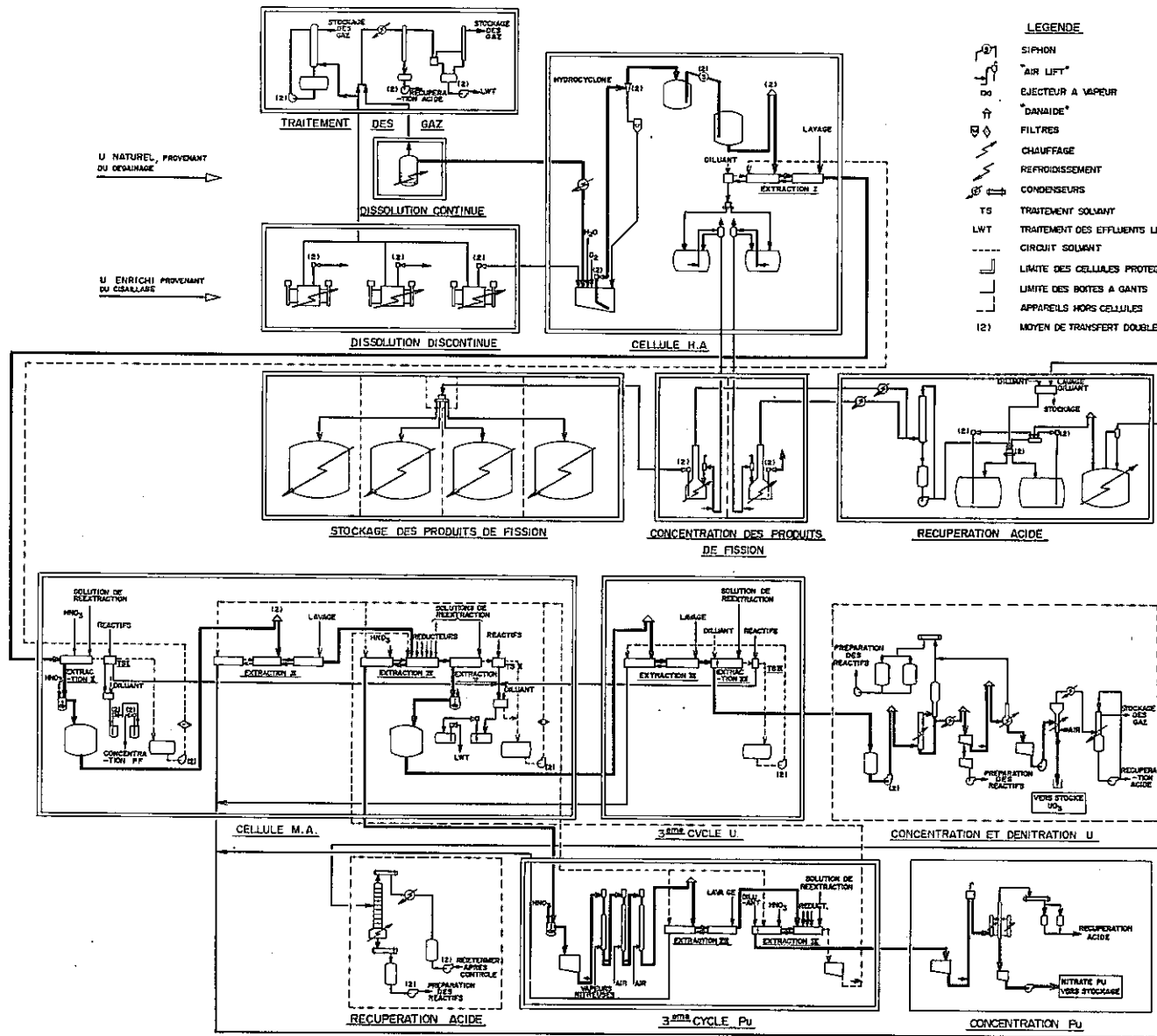

LEGENDE

- SIPHON
- "AIR LIFT"
- EJECTEUR A VAPEUR
- "DANAIDE"
- FILTRES
- CHAUFFAGE
- REFROIDISSEMENT
- CONDENSEURS
- TRAITEMENT SOLVANT
- LWT
- CIRCUIT SOLVANT
- LIMITE DES CELLULES PROTEGES
- LIMITE DES BOTES A GANTS
- APPARELS HORS CELLULES
- MOYEN DE TRANSFERT DOUBLE

This figure is quoted from the paper titled 'L'ensemble industriel de traitement des combustibles irradiés au Japon', written by Robert Curillon and Jacques Viennot (Saint-Gobain Techniques Nouvelles), published by ÉNERGIE NUCLÉAIRE, Vol. 10, No. 3 MAI 1968.

Fig. 3.1 General Scheme of Chemical Treatment

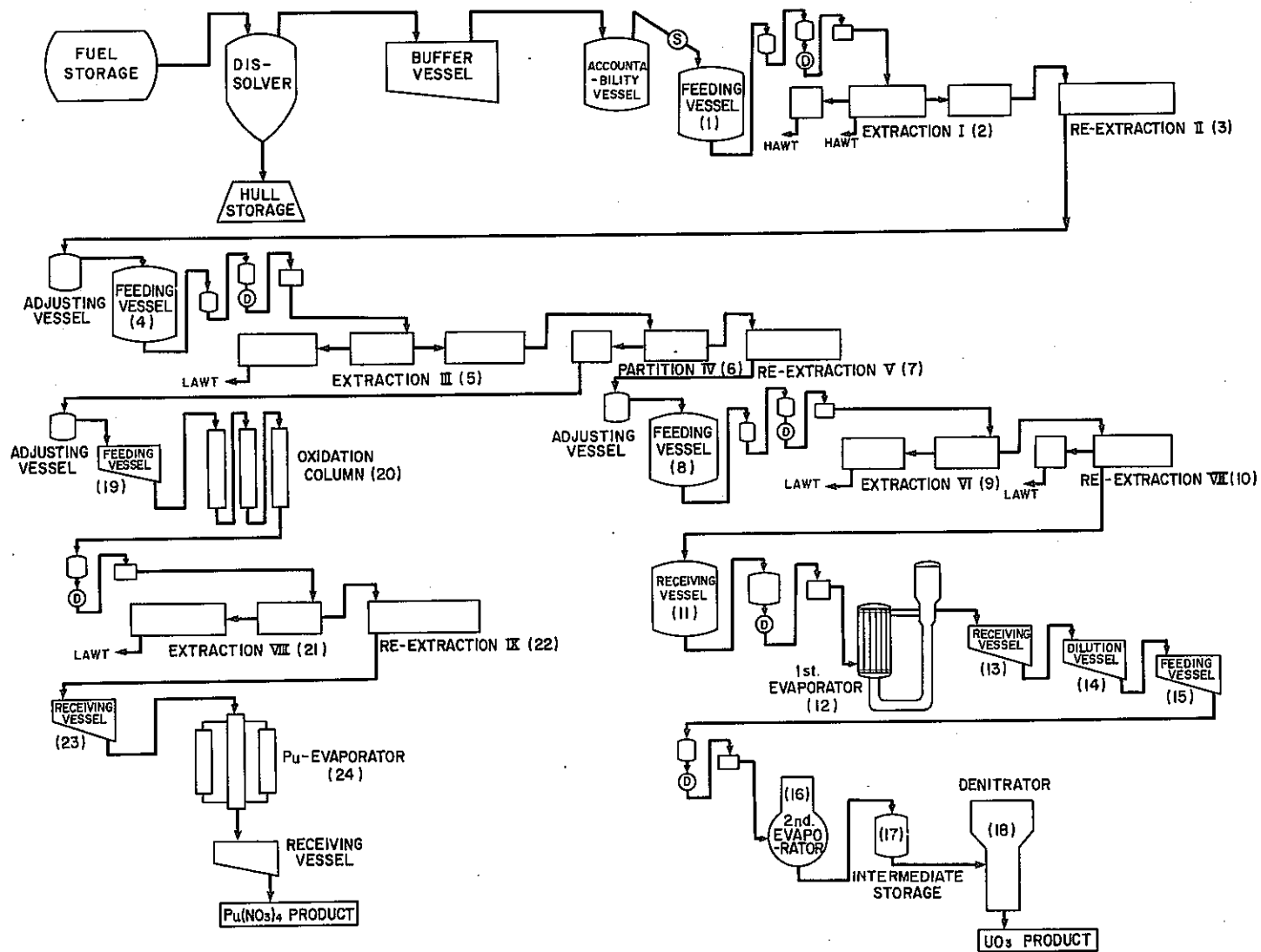
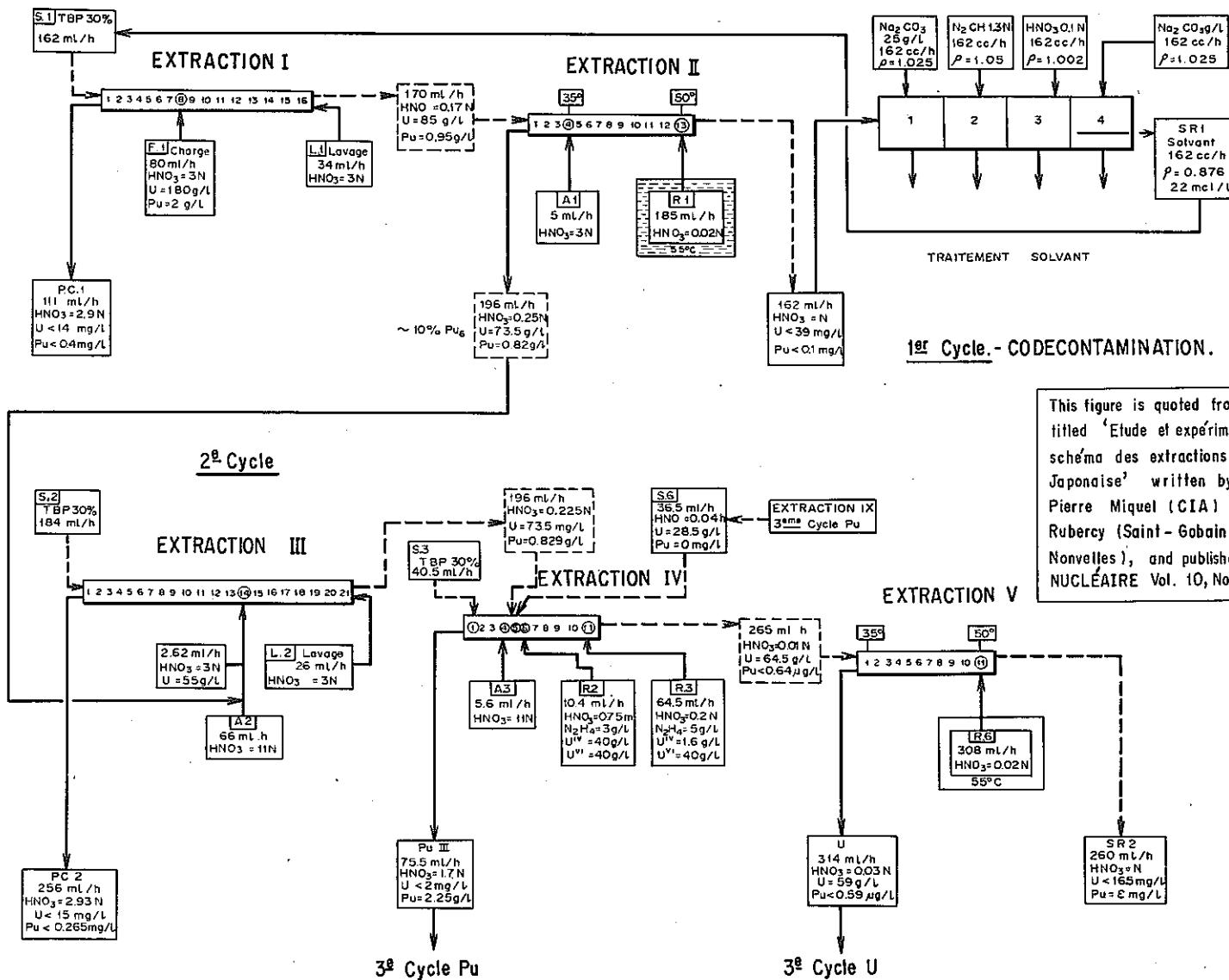
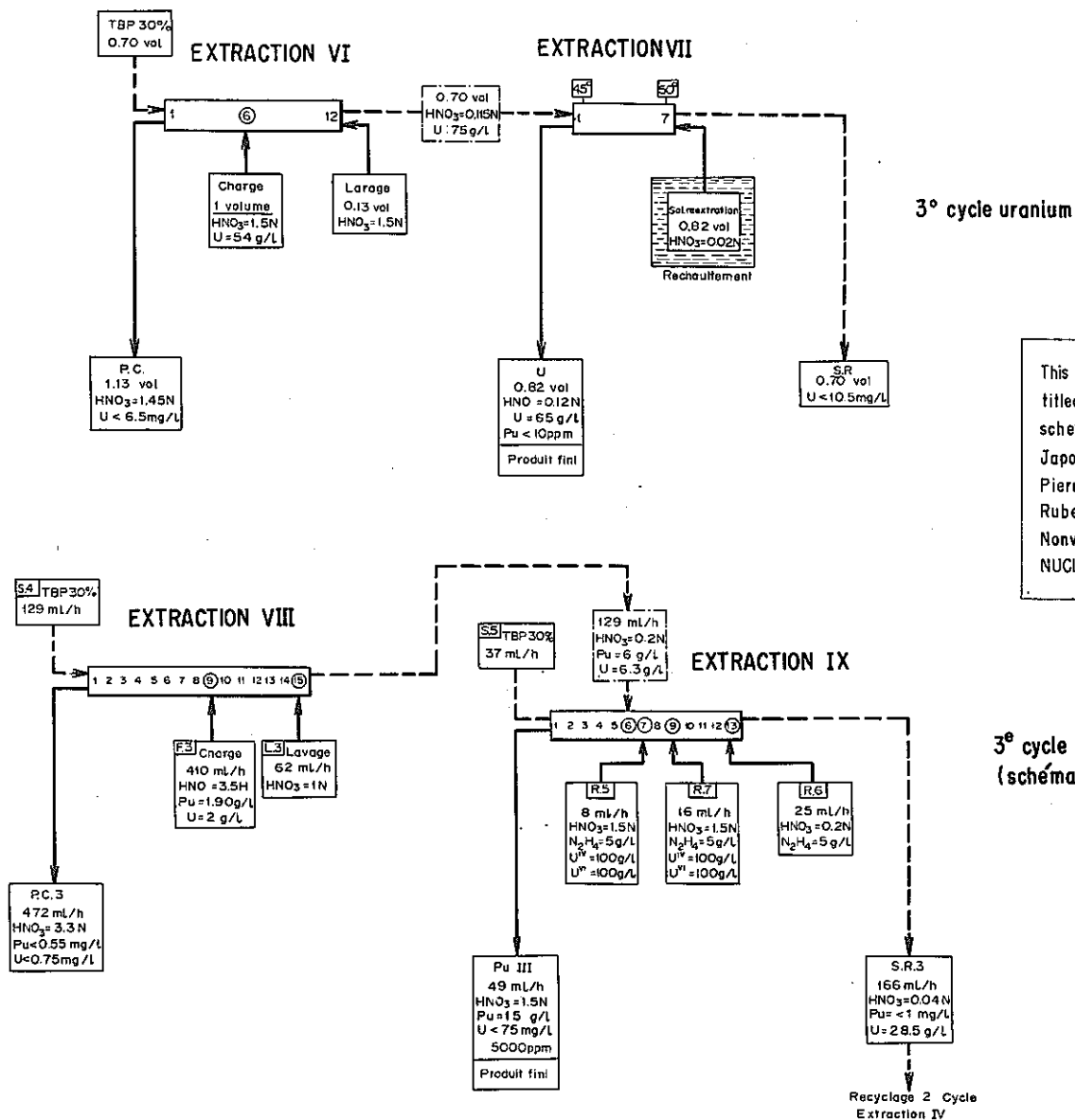

Fig. 3.2 Schematic Flowsheet of the Model Reprocessing Plant



This figure is quoted from the paper titled 'Etude et experimentation du schéma des extractions de l'usine Japonaise' written by Guy Lefort and Pierre Miquel (CIA) and Michel De Rubercy (Saint-Gobain Techniques Nonvelles), and published by ÉNERGIE NUCLÉAIRE Vol. 10, No. 3, MAI 1968

Fig. 3.3 Flowsheet of Co-decontamination and Partition Process



This figure is quoted from the paper titled 'Etude et experimentation du schéma des extractions de l'usine Japonaise' written by Guy Lefort and Pierre Miquel (CIA) and Michel De Rubercy (Saint-Gobain Techniques Nouvelles), and published by ENERGIE NUCLEAIRE Vol. 10, No. 3, MAI 1968

Fig. 3.4 Flowsheet of Purification Processes of Uranium and Plutonium

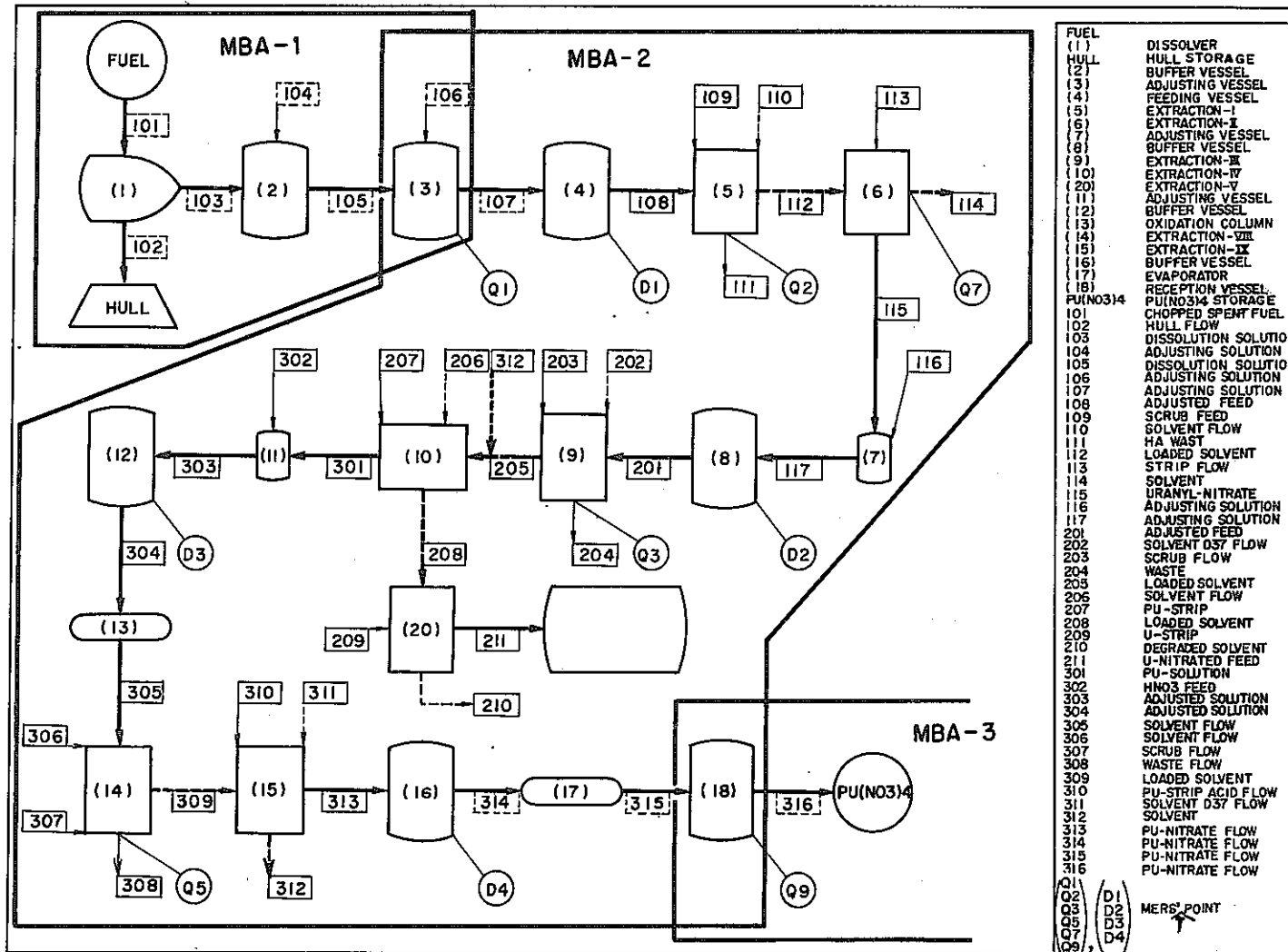
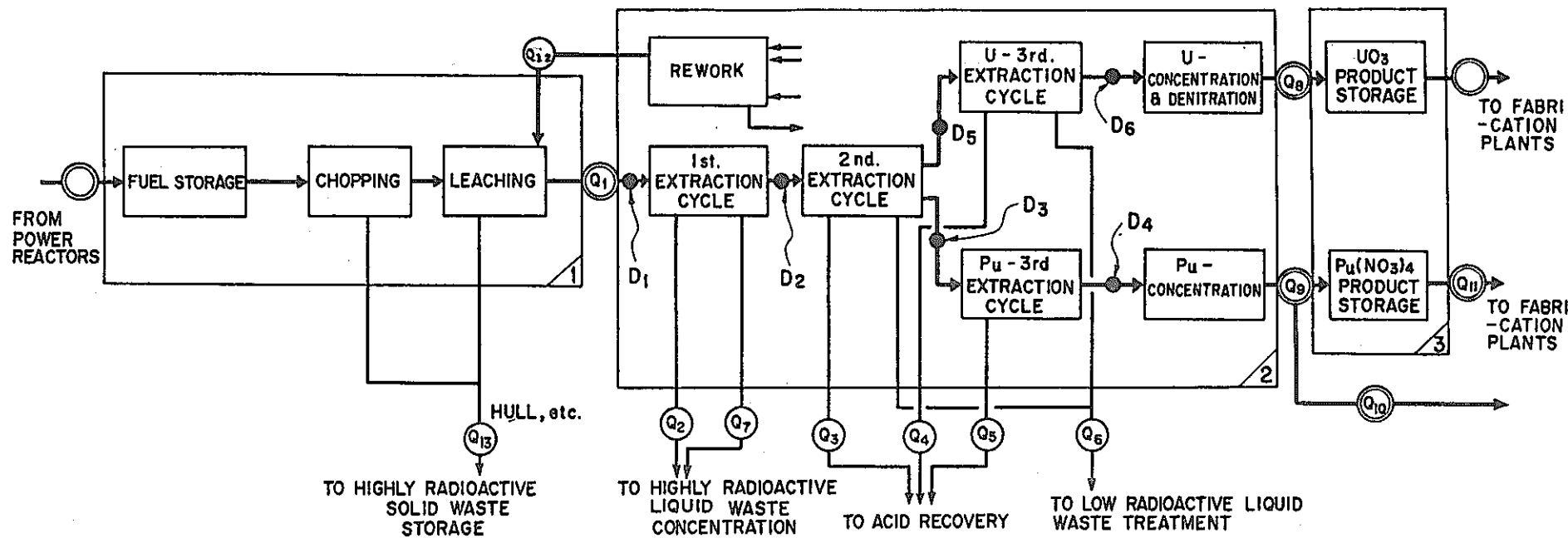

Fig. 3.5 MODEL REPROCESSING PLANT PROCESS FLOW



	Q ₁	Q ₂	Q ₃	Q ₄	Q ₅	Q ₆	Q ₇	Q ₈	Q ₉	Q ₁₀	Q ₁₁	Q ₁₂	Q ₁₃
	ADJUSTED FEED	1st. CYCLE EFFLUENT	2nd. CYCLE EFFLUENT	U-3rd CYCLE EFFLUENT	Pu-3rd CYCLE EFFLUENT	SOLVENT WASH EFFLUENT	SOLVENT WASH EFFLUENTS	U-PRODUCT (UO ₃)	Pu-PRODUCT (Pu(NO ₃) ₄)	Pu-PRODUCT SHIPPING OUT	Pu-PRODUCT SHIPPING OUT	REWORK EFFLUENT	HULLS
Batch / DAY	2	2	1	1	1	2	2	2	1	—	—	—	—

D₁ ~ D₆ = MEASUREMENT POINTS FOR IN-PROCESS INVENTORY

Material Balance Area 2 is defined as material balance area for the near-real-time material accountability.



- BUFFER VESSEL ... IN-PROCESS ACCOUNTABILITY POINTS
- MAIN ACCOUNTABILITY POINT
- OTHER ACCOUNTABILITY POINT

Fig. 3.6 Schematic diagram of materials accounting

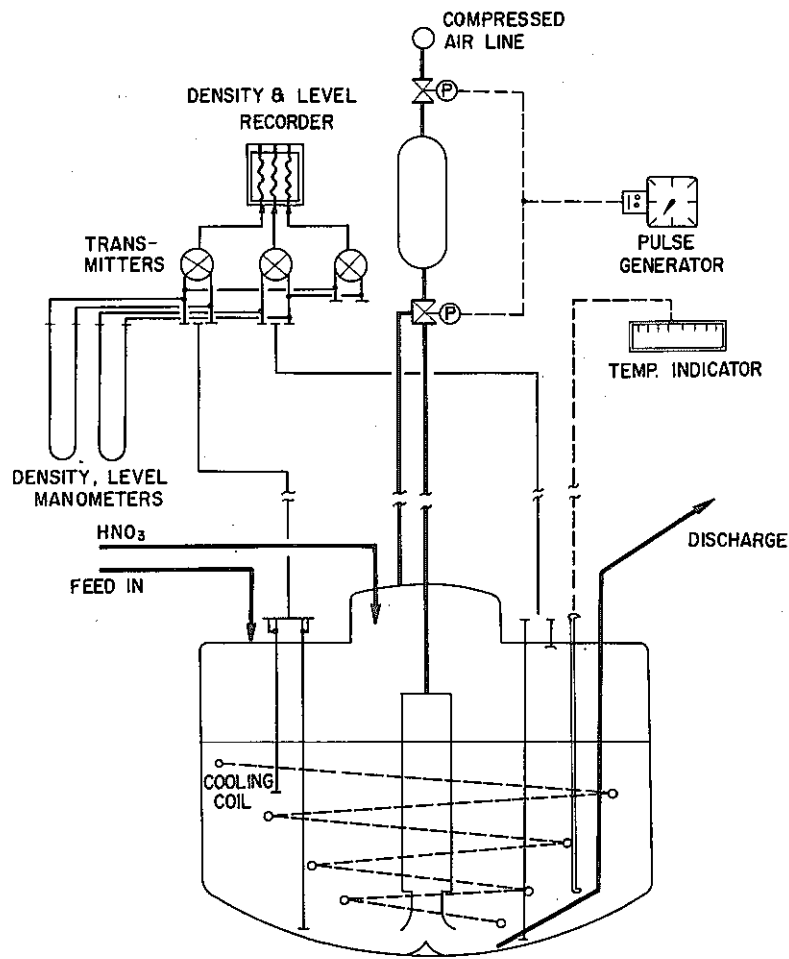

Fig. 3.7 Volume Measurement System of Input Accountability Vessel

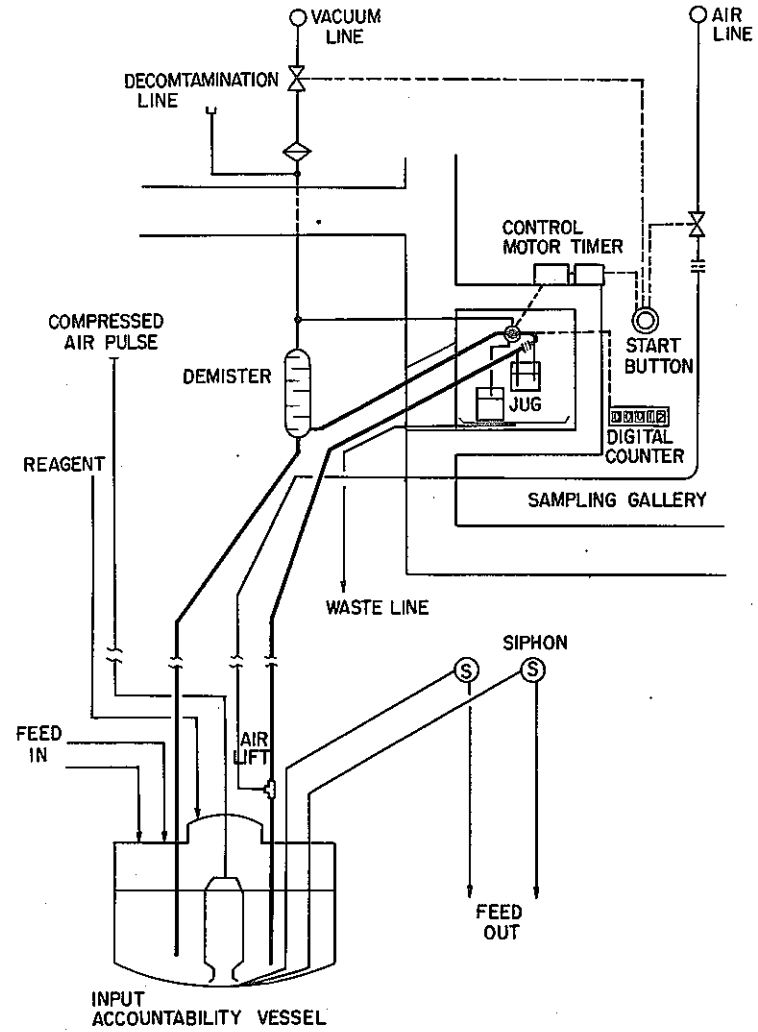

Fig. 3.8 Sampling System of Input Accountability Vessel

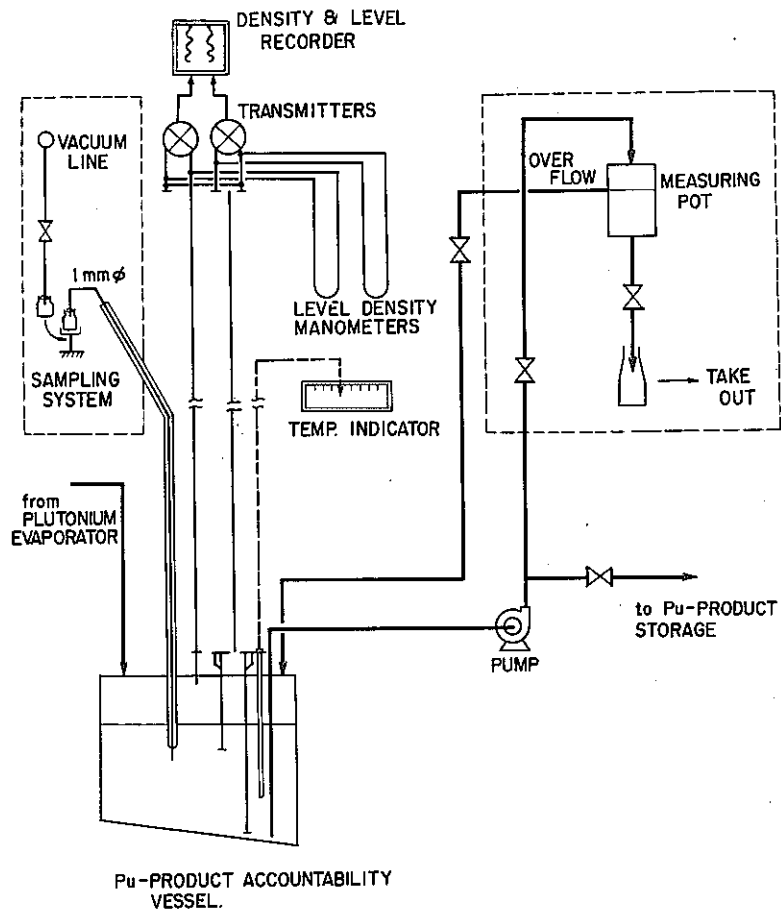

Fig. 3.9 Volume Measurement and Sampling System for Pu-product

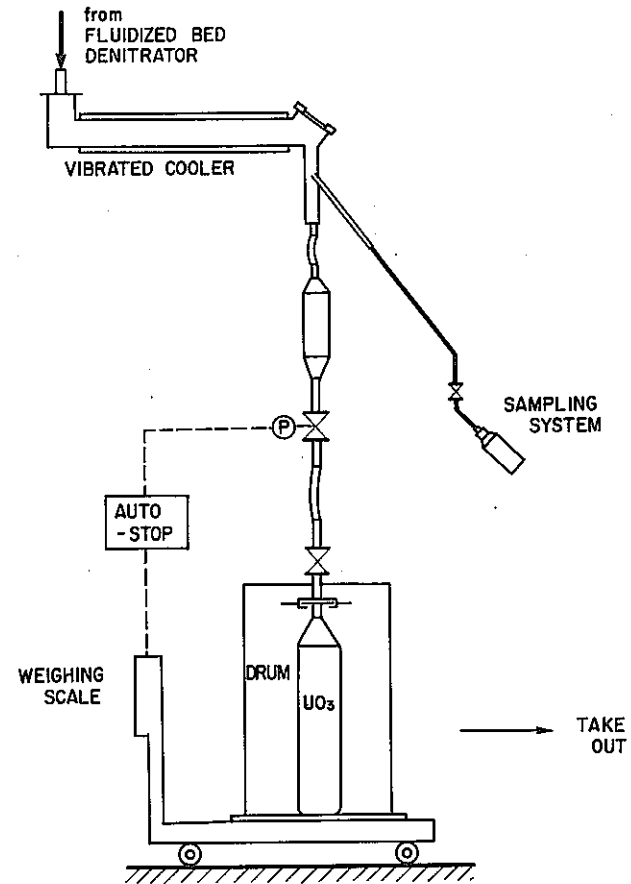

Fig. 3.10 Weighing and Sampling System for U-product (UO₃-powder)

4. N.R.T. MATERIALS ACCOUNTANCY MODEL FOR THE MODEL PLANT
-- Ten Day Detection Time Model --

4.1 General

This study examines the feasibility of preparing weekly material balances, with the results to be available for evaluation and action no later than three days after the inventory cut-off point. That is, Equation (2.2) is to be solved once per week, and three days are allowed for the collection and evaluation of the data. It is perhaps a misnomer to refer to such a system as "near-real-time", but in actual fact essentially all of the problems associated with true near-real-time materials accountancy also exist in this very simple system. If any of the problems cannot be solved at this point, then the conclusion of this study must be that near-real-time materials accountancy of spent fuel reprocessing facilities is not feasible. On the other hand, if a ten-day-detection-time system can be shown to be feasible (and ideally, can be demonstrated in actual practice), then more truly near-real-time accountancy systems are purely problems of degree. The ten-day-detection-time system will also serve as a benchmark against which the relative cost and relative effectiveness of more rapid and more timely systems can be evaluated.

4.2 Measurement of Input Quantities

The reference model facility will generate approximately thirteen input dissolver batches during the course of one week's normal operation, each containing perhaps 3 kgs plutonium. Since some of these batches will be generated 8-10 days before the analytical data is required, it can be assumed that the normal high quality input measurement data will be available for some of the batches. Whether this data can be supplied for all batches is a question which perhaps can best be answered on an individual facility basis. The assumption here is that the last two or three analyses will have to be performed by some other method, e.g., one which can give a rapid provisional value.

Since it should be possible to complete high quality measurements on all input dissolution samples within one additional week, the best procedure probably is to treat MUF_d for the latest material balance period

(the one which contains some provisional input measurements) as a provisional MUF_d , to be corrected as soon as all high quality measurements are completed. Such a procedure would provide the desired timely detection capability for an abrupt single diversion of a significant quantity of plutonium, while at the same time providing maximum sensitivity (minimum uncertainty) for the detection of long term small quantity diversion.

4.3 Measurement of Output Quantities

4.3.1 Product Solution

The reference model facility will generate approximately five batches of plutonium product solution during the course of one week's normal operation, each containing about 8 kgs Pu. It is assumed that within the three days allowed for the completion of measurements and the statistical evaluation of n.r.t. material balance data, all of these batches can be analyzed by the normal high precision methods. On occasion it may be necessary to use some provisional method for the last batch sampled, or possibly (if the situation arises only rarely) to delay the evaluation of the material balance data for the few hours required to complete the last analysis.

4.3.2 Waste Materials

Under normal operating conditions the amount of Pu contained in discarded waste materials is small, and the measurements performed normally are completed rapidly. In the ten day model it is assumed that each material balance will be credited with the Pu contained in all waste generated and measured during the material balance period.

4.4 Measurement of Physical Inventory

4.4.1 General

Fig. 4.1 shows the designated inventory cut-off point with solution volumes in the major vessels designed for in-process physical inventory for the n.r.t. materials accountancy. This inventory cut-off point is chosen at some adequate time point when the evaporator became empty. This is

because of the difficulty to measure the volume and density of solution in the evaporator.

At the designated inventory cut-off point, the model plant may be expected to have on inventory the following materials:

- a) one or two partially dissolved batches of spent fuel;
Since these have not yet reached the point of input to the process area, they are not included in the n.r.t. material balance.
- b) about 0 ~ 4 kgs Pu in the accountability vessel;
- c) about 5 ~ 10 kgs Pu in four buffer storage vessels;
- d) about 1 ~ 2.5 kgs Pu in three mixer-settler extraction systems;
- e) about 5 ~ 9 kgs Pu in the product reception vessel; and
- f) perhaps up to 500 gms Pu in a wide variety of smaller equipment items.

In the system studied here, no attempt is made to measure the relatively small quantity of material in miscellaneous equipment items. As was noted in section 2.2, at steady-state it is only the variation in this inventory which appears in MUF_d , and this variation should not exceed 100 ~ 200 grams Pu. The procedures for the determination of the in-process physical inventory in the buffer tanks, the product evaporator, and the mixer-settler extraction systems, and the potential problems foreseen in determining those inventory quantities, are discussed in the paragraphs that follow.

4.4.2 Buffer Storage Vessels

Since dissolution is a batch process and the mixer-settler extraction systems must be operated in a continuous mode, buffer storage vessels must exist to maintain a steady feed to the mixer-settler systems. A similar buffer storage vessel is required at the feed to the product evaporator, in order to allow evaporation to be stopped periodically while the evaporator is discharged. These four storage vessels are expected to contain, as noted above, about 5 ~ 10 kgs Pu (combined).

All four vessels are equipped with level recorders, density recorders, temperature indicators, and sample lines, so in principle weekly inventory measurements should present no problem. However, all four tanks are constantly receiving and discharging solution (except the feed to the first cycle extraction system, which receives dissolver solution intermittently), and it is not clear that the tanks can be isolated for the time required to perform a volume measurement and take a sample. (The field test results

showed that such isolation was not necessary, since for in-process inventory purposes the short term variations in concentration was negligible.)

Thus, the measurement procedures are as follows:

- a) prior to the designated inventory cut-off time, homogenize solution in each of the tanks preparatory to sampling,
- b) at the designated cut-off time, sample each tank, and
- c) from the level recorder, determine the tank volume at the time the sample was taken.

It is not essential that "inventory cut-off time" be interpreted rigidly, so long as a reasonable effort is made to follow consistent procedures and to achieve the same cut-off time each week. Thus for example, if only one NDA measuring instrument were available there would be no difficulty with measuring the four tanks in sequence. If possible the same sequence should be used each week, and the volume used should be the volume at the time of actual sampling, not the volume at the defined cut-off point. Variations such as these introduce some additional uncertainty into the statistical evaluations, but the magnitude of this uncertainty should be negligible.

The most convenient analytical procedure for measuring the Pu concentration in these tanks may be X-ray fluorescence as the logical analytical method for at least the first two tanks, and may be the logical choice for all four tanks.

4.4.3 Product Evaporator

Plutonium product from the third cycle extraction system is concentrated in the plutonium product evaporator according to the following sequence. Starting with an empty evaporator, solution having a concentration of less than 15g/l Pu is fed to the evaporator at a rate sufficient to maintain a constant volume in the evaporator of about 30 liters. As evaporation continues the concentration of plutonium in the evaporator gradually increases until it reaches a minimum of 250g/l. When the desired concentration is reached, feed to the evaporator is interrupted and the product solution is discharged to the product measuring tank. Evaporator feed is then resumed, and the cycle is repeated. Evaporator discharge should occur about once per day when the spent fuel being processed has had a "normal" burnup irradiation. With low burnup fuel, however, evaporator

discharge would occur less often.

The feasibility of draining the evaporator for purposes of measurement, with the partially evaporated solution being returned to the evaporator after measurement, was investigated and found not to be feasible. The only available return line would require the solution to pass through equipment which was not critically safe at high concentrations, and therefore would mean dilution, thus undoing the evaporative work which had already been done.

The evaporator itself has the necessary level recorder, sample line, etc., for direct inventory measurement, but the fact that the solution is boiling makes any precise determination of volume difficult. There will also be concentration gradients which may make use of the sample for materials accountancy purposes difficult. Nevertheless, it is suggested that the feasibility of direct measurement of the Pu content of the evaporator deserves further study.

The other alternative, and the one recommended here at least for interim use, is to schedule the seven day material balance period such that the ending physical inventory is always taken immediately after the evaporator has been discharged, and before evaporator feed is resumed. The sequence of events would be as follows:

- a) as close as possible to the scheduled inventory cut-off point, discharge the evaporator. If evaporator discharge normally occurs once every 24 hours it should always be possible to choose a discharge which is within 12 hours of the desired time. With a bit of effort on the part of production planning personnel, it should be possible to come considerably closer at least most of the time.
- b) measure the volume of solution in the evaporator feed tank, and sample the tanks, using the procedures discussed in paragraph 4.4.2 above.
- c) measure the volume, sample, etc., the remaining buffer storage tanks, meanwhile resuming feed to the evaporator from the measured evaporator feed tank.
- d) the quantity of plutonium discharged from the evaporator, since it was discharged prior to the inventory cut-off point, would be considered as a product flow batch, not as an inventory batch.

4.4.4 Mixer-Settler Extraction Systems

The reference model facility uses mixer-settler extraction systems for

decontamination, partition, and final purification of plutonium and uranium. Whether a given actual facility uses mixer-settler, pulse columns, or even centrifugal contactors, however, is unimportant. So long as the facility follows the Purex flowsheet, it contains organic-aqueous extraction equipment, and these extraction units contain a significant quantity of plutonium (2500 g Pu in the reference facility). The inability to perform meaningful physical inventory measurements (other than by cleanout, which is assumed to be forbidden) imposes a basic limitation on the effectiveness of any n.r.t. materials accountancy system. For the relatively small facilities considered here this limitation is not serious, as shown later, but for future large scale facilities the Pu inventory in the extraction equipment, and the normal variations in that inventory, may prove to be the limiting factor in n.r.t. materials accountancy effectiveness.

The alternative usually considered is statistical control of the apparent book inventory, using CUSUM and Kalman filter techniques which are extremely sensitive to bias. Simulated examples are shown later.

There may be one other alternative, however, in the form of an adaptation of the computer simulation technique using codes, SEPHISJ or PUBG. SEPHISJ is a JAERI version of SEPHIS, originally developed by Savannah River and adapted for a 30 % TBP flowsheet by ORNL. SEPHISJ has been used in this study and presented satisfactory results. This experience shows that SEPHISJ can be used to estimate holdups in the mixer-settler system, when it is incorporated into the n.r.t. materials accountancy computer system.

PUBG has been developed specifically for mixer-settler systems, at Clemson University under the LANL safeguards study, as a new code which can dependably estimate the actual inventory in a non-equilibrium system, while SEPHIS is an equilibrium state model. It is hoped that a simplified model to estimate the total Pu inventory can be developed by using PUBG.

4.5 Statistical Analysis Method

Statistical evaluation procedures used in the study are essentially those developed at the Los Alamos National Laboratory. The complete computer package includes four statistical tests, a straightforward cumulative sum (CUMUF) test, a uniform diversion test based on the Kalman filter statistic, a variance test, and a two directional test based on two

Kalman filter models operating in opposite directions. The purposes of these tests are as follows:

- (a) CUMUF - this statistic provides a relatively powerful test which is in general not dependent on an assumed diversion pattern,
- (b) uniform diversion - as the name implies, this test is more sensitive when the divertor follows the nominally optimum strategy of diverting a uniformly small quantity during each material balance period,
- (c) variance test - if a would-be divertor attempts to defeat the statistical tests by diverting in a random manner, the observed variance of the MUF data will be significantly larger than the variance derived from the component measurement uncertainties. The variance test is designed to give increased detection sensitivity against randomized diversions by detecting this increased variance in the data,
- (d) two-directional test - this test recognizes that a revised estimate of the inventory at any earlier point in time can be derived from a consideration of subsequent flow and inventory data. In borderline situations it is expected that a two-directional test would be more sensitive to possible abrupt diversions.

Although early feasibility studies using simulated data considered all four of these tests, most work has been with only the first two. It seems likely that in actual practice primary reliance will be on the CUMUF and uniform diversion tests, and that the other tests will be used only to provide supplementary evidence, or to suggest the need for further investigation of possible borderline situations.

Fig. 4.2 is the block diagram of the decision analysis procedure which is adopted in the present computer system for safeguards data analysis.

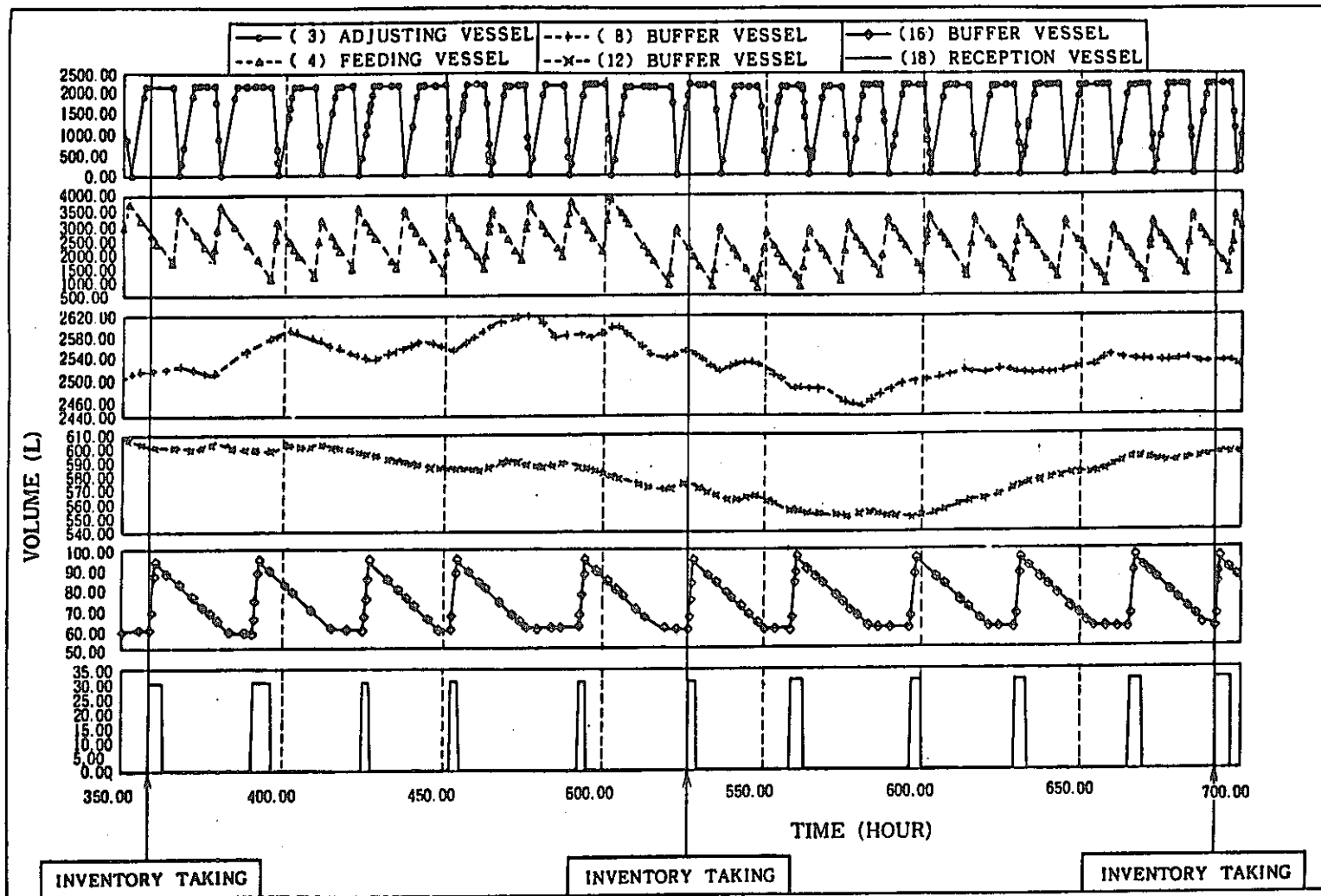

Fig. 4.1 Graphic representation of variations in volume of solution in the major measurement points. Three inventory cut-off points are also indicated. Each point is chosen at a particular point of time immediately after the evaporator become empty and before evaporator feed is resumed

DECISION ANALYSIS

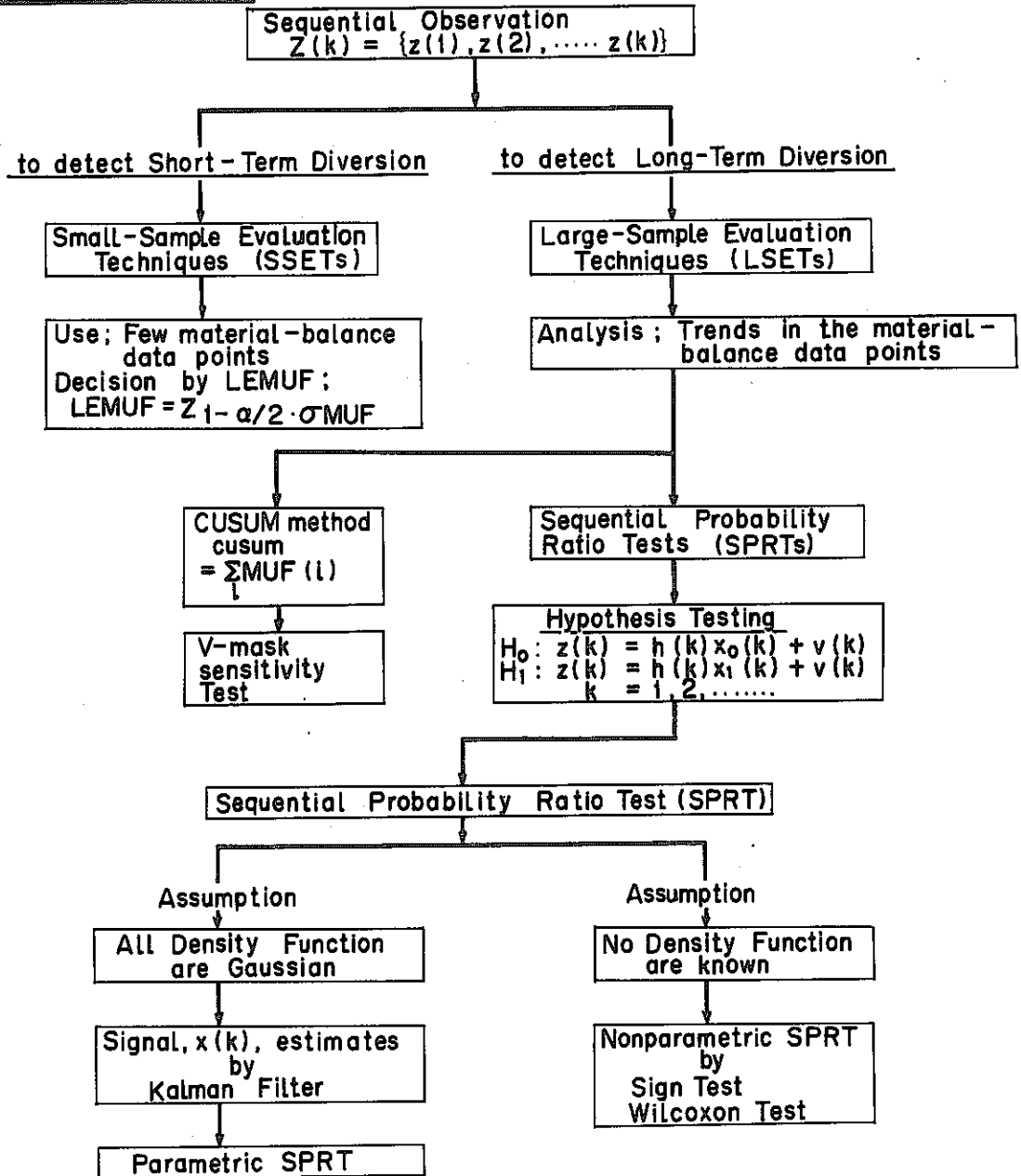

Fig. 4.2 Block diagram of the decision-analysis

5. EFFECTIVENESS EVALUATION BY MODELING AND SIMULATION STUDIES

5.1 Evaluation Method of N.R.T. Materials Accountancy Effectiveness

5.1.1 General

Since operating histories from reprocessing facilities are not always available, simulated data are required for evaluation of proposed materials accountancy systems. For this purpose, a dynamic mathematical model of a reprocessing plant has been developed. The model includes almost all major processes in a reprocessing plant, but some parts, e.g., uranium purification process, waste disposal processes, solvent recovery processes, were not used in this simulation study.

Based on this model a flow simulation code "DYSAS-R" (Dynamic Safeguards Simulation code for Reprocessing facility) has been developed. In-process material flows and inventories under ideal operating conditions, including approximated special operations, such as plant-start-up, flush-out, clean-out operations, were simulated by the code DYSAS-R. The simulated process flow data were treated as "true values" for measurement procedures having specified measurement uncertainties.

Models of accountability measurements and associated measurement error propagations were simulated by a code "SIMAC" (Simulation of Measurements and Accountancy) and are described later.

The simulated material balance data were analyzed by powerful data-analysis and sequential-decision techniques. The general framework of these techniques developed by LANL(3), was used here with some modification. The procedure of sequential-decision analysis is shown by the block diagram in Fig. 4.2, and a computer code, "SADAC" (Safeguards Data Analysis Code) has been developed, while a part of it is still under improvement.

5.1.2 Measurement Simulation

In order to simulate measurements and accounting procedures, a Monte Carlo computer code SIMAC has been developed. In this chapter the measurement error propagation model incorporated into SIMAC is described.

The model was described by J.L. Jaech (4) with regard to the measurement of nuclear materials. Some of the description in this chapter refers to that report.

This code, SIMAC, simulates measurements and analyses of materials using flow-simulation data generated in advance by DYSAS-R. The simulated 'measurement data' are analyzed by SADAC, in which the current statistical analysis methods and the sequential decision analysis techniques are used. In the code, SIMAC, a multiplicative measurement-error propagation model (relative error) is assumed.

(1) Measurement-error model

It is generally assumed that measurement errors consist of three components, which can be defined as follows:

- a) Random error:
an error that affects only a single member of a given data set.
- b) Short-term systematic error:
the error that affects a sequence of members of the data set, but not the entire data set.
- c) Long-term systematic error (or bias):
an error that affects all members of the data set.

For error components, further assumptions are made:

- a) All error-component random variables are unbiased; i.e., they are distributed with zero means. This means that all known measurement biases have been appropriately corrected.
- b) All error components are uncorrelated, i.e., all covariances between the error-component random variables are zero. Error components and associated standard deviations are designated for individual components in the next page.

Using these definitions observations on the weight, element factor and isotope factor of an item of nuclear material can be written by following expressions.

$$w = W(1 + \delta + \phi + \epsilon),$$

$$\bar{p} = P(1 + \Delta + \bar{\psi}(S) + \bar{\eta}(m) + \theta + \bar{\beta}(A) + \bar{\omega}(d)),$$

$$\bar{t} = T(1 + \lambda + \bar{\pi}(R) + \bar{\mu}(q) + \gamma + \bar{\alpha}(B) + \bar{v}(k)),$$

Definition of Standard Deviations

Operation	Type of error component		
	Long-term systematic	Short-term systematic	Random
Bulk measurement	σ_{δ}	σ_{ϕ}	σ_{ϵ}
Sampling, element	σ_{Δ}	σ_{ψ}	σ_{η}
Analytical, element	σ_{θ}	σ_{β}	σ_{ω}
Sampling, isotope	σ_{λ}	σ_{π}	σ_{μ}
Analytical, isotope	σ_{γ}	σ_{α}	σ_{ν}

where

w = observed net weight (or volume) or the contents,

p = element factor applied to the contents,

t = isotope factor applied to the contents,

m = number of samples on which p is based,

d = number of analytical determinations on which p is based,

s_i = number of samples drawn under condition i for element analyses,

$$\text{with } \sum_{i=1}^S s_i = m,$$

a_i = number of element analyses made under condition i, with $\sum_{i=1}^A a_i = m$,

q = number of samples on which t is based,

k = number of analytical determinations on which t is based,

r_i = number of samples drawn under condition i for isotope

$$\text{analyses, with } \sum_{i=1}^R r_i = q,$$

b_i = number of isotope analyses made under condition i, with $\sum_{i=1}^B b_i = k$,

W, P, T = true values of the weight, element factor and isotope factor of the item, respectively. (In our simulation system, these values are generated by the flow-simulation code; DYSAS-R).

Then, the amount of isotope determined for the item in question, M, is given by

$$\begin{aligned}
 M = \overline{wpt} &= (WPT)(1 + \delta + \phi + \epsilon) \\
 &\cdot (1 + \Delta + \overline{\psi}(S) + \overline{\eta}(m) + \theta + \overline{\beta}(A) + \overline{\omega}(d)) \\
 &\cdot (1 + \lambda + \overline{\pi}(R) + \overline{\mu}(q) + \gamma + \overline{\alpha}(B) + \overline{\nu}(k)). \quad (5.1)
 \end{aligned}$$

And its variance is

$$\begin{aligned}
 \sigma_M^2 &= (WPT)^2 (\sigma_\delta^2 + \sigma_\phi^2 + \sigma_\epsilon^2 + \sigma_\Delta^2 + \sigma_\psi^2 + \sigma_\eta^2 + \sigma_\theta^2 + \sigma_\beta^2 + \sigma_\omega^2 + \sigma_\lambda^2 \\
 &\quad + \sigma_\pi^2 + \sigma_\mu^2 + \sigma_\gamma^2 + \sigma_\alpha^2 + \sigma_\nu^2) \quad (5.2)
 \end{aligned}$$

where

$$\begin{aligned}
 \sigma_\psi^2 &= c_0 \sigma_\psi^2, \quad \sigma_\eta^2 = \frac{\sigma_\eta^2}{m}, \quad \sigma_\beta^2 = c_1 \sigma_\beta^2, \quad \sigma_\omega^2 = \frac{\sigma_\omega^2}{d}, \\
 \sigma_\pi^2 &= g_0 \sigma_\lambda^2, \quad \sigma_\mu^2 = \frac{\sigma_\mu^2}{p}, \quad \sigma_\alpha^2 = g_1 \sigma_\alpha^2, \quad \sigma_\nu^2 = \frac{\sigma_\nu^2}{k},
 \end{aligned}$$

with

$$c_0 = \frac{S}{i=1} \frac{s_i^2}{m^2}, \quad c_1 = \frac{A}{i=1} \frac{a_i^2}{d^2}, \quad g_0 = \frac{R}{i=1} \frac{r_i^2}{p^2}, \quad g_1 = \frac{B}{i=1} \frac{b_i^2}{k^2}.$$

In a simulation procedure, a value of error component, for example, ϵ , is a random variable which is generated as a deviate from a normal distribution of the mean value, zero, and the variance σ_ϵ^2 . In case of a random error component, an individual random variable is generated for a single measurement. In case of a short-term systematic error, a new random variable is generated only when a set of conditions is different from previous one (A "set of conditions" may refer to a given calibration period). On the contrary, a random variable is generated at the initiation of the simulation, and it is used throughout the simulation of interest without any change, in case of long-term systematic error.

(2) Material balance

In terms of the net transfer T , beginning inventory I_b , and ending inventory I_e , the material-balance is defined by

$$(MB) = I_b + T - I_e \quad (5.3)$$

On the other hand, a material balance is a linear combination of quantities $(M)_i$ measured in a specified period of time:

$$(MB) = \sum_{i=1}^n a_i (M)_i \tag{5.4}$$

where $a_i = +1$, if $(M)_i$ is an input quantity to the accounting area and $a_i = -1$, if $(M)_i$ is an output from the area. $(M)_i$ is calculated by Eq.(5.1) for the i -th material. Accordingly we consider the variance of an algebraic sum of the amount of items of nuclear material. As indicated, there are five basic types of measurement operations: bulk determination, sampling for element, analysis for element, sampling for isotope, and analysis for isotope. With each type of measurement, a number of specific operations are identified as set forth below.

Specific Measurement Operations

Type of operation	Specific operation
Bulk determination (weighing or volume)	Weighing performed in scale i , or volume of of vessel i ; $i = 1, 2, \dots, n_i$
Sampling for element	Sampling from material type j or by method j $j = 1, 2, \dots, n_j$
Analyses for element	Analytical method k ; $k = 1, 2, \dots, n_k$
Sampling for isotopic factor	Sampling for material type ℓ or by method ℓ $\ell = 1, 2, \dots, n_\ell$
Analysis for isotopic factor	Analytical method m ; $m = 1, 2, \dots, n_m$

In this model each specific operation has associated with it a long-term systematic, a short-term systematic, and a random error.

Each combination of a specific operation and a type of error contributes a term to the overall variance of the nuclear material in the algebraic sum. This term consists of a coefficient times an appropriate variance. From the notation previously made, the terms are of the following form:

$$C_{\delta i} \sigma_{\delta i}^2 ; C_{\phi i} \sigma_{\phi i}^2 ; \dots ; C_{\nu m} \sigma_{\nu m}^2$$

with the ranges for $i, j, k, l,$ and m given previously. The variance of material balance is calculated by

$$\begin{aligned} \sigma_{MB}^2 = & \sum_{i=1}^{n_i} (C_{\delta_i} \sigma_{\delta_i}^2 + C_{\phi_i} \sigma_{\phi_i}^2 + C_{\epsilon_i} \sigma_{\epsilon_i}^2) \\ & + \sum_{j=1}^{n_j} (C_{\Delta_j} \sigma_{\Delta_j}^2 + C_{\psi_j} \sigma_{\psi_j}^2 + C_{\eta_j} \sigma_{\eta_j}^2) \\ & + \sum_{k=1}^{n_k} (C_{\theta_k} \sigma_{\theta_k}^2 + C_{\beta_k} \sigma_{\beta_k}^2 + C_{\omega_k} \sigma_{\omega_k}^2) \\ & + \sum_{l=1}^{n_l} (C_{\lambda_l} \sigma_{\lambda_l}^2 + C_{\pi_l} \sigma_{\pi_l}^2 + C_{\mu_l} \sigma_{\mu_l}^2) \\ & + \sum_{m=1}^{n_m} (C_{\gamma_m} \sigma_{\gamma_m}^2 + C_{\alpha_m} \sigma_{\alpha_m}^2 + C_{\nu_m} \sigma_{\nu_m}^2) \end{aligned} \quad (5.5)$$

where

$$\begin{aligned} C_{\delta_i} &= \left(\sum_{n \in N_i} S_n \right)^2, & C_{\phi_i} &= \frac{I_i}{\sum_{i'=1}^{I_i} \left(\sum_{n \in N_{ii'}} S_n \right)^2}, & C_{\epsilon_i} &= \sum_{n \in N_i} \frac{(S_n)^2}{l_i}, \\ C_{\Delta_j} &= \left(\sum_{n \in N_j} S_n \right)^2, & C_{\psi_j} &= \frac{J_j}{\sum_{j'=1}^{J_j} \left(\sum_{n \in N_{jj'}} S_n \right)^2}, & C_{\eta_j} &= \sum_{n \in N_j} \frac{(S_n)^2}{l_j}, \\ C_{\theta_k} &= \left(\sum_{n \in N_k} S_n \right)^2, & C_{\beta_k} &= \frac{K_k}{\sum_{k'=1}^{K_k} \left(\sum_{n \in N_{kk'}} S_n \right)^2}, & C_{\omega_k} &= \sum_{n \in N_k} \frac{(S_n)^2}{l_k}, \\ C_{\lambda_l} &= \left(\sum_{n \in N_l} S_n \right)^2, & C_{\pi_l} &= \frac{L_l}{\sum_{l'=1}^{L_l} \left(\sum_{n \in N_{ll'}} S_n \right)^2}, & C_{\mu_l} &= \sum_{n \in N_l} \frac{(S_n)^2}{l_l}, \\ C_{\gamma_m} &= \left(\sum_{n \in N_m} S_n \right)^2, & C_{\alpha_m} &= \frac{M_m}{\sum_{m'=1}^{M_m} \left(\sum_{n \in N_{mm'}} S_n \right)^2}, & C_{\nu_m} &= \sum_{n \in N_m} \frac{(S_n)^2}{l_m}, \end{aligned}$$

with

N_i, N_j, N_k, N_l, N_m : the data set which satisfies condition of specific operation n_i, n_j, n_k, n_l, n_m ,

I_i, I_j, I_k, I_l, I_m : number of "set of condition" for short-term systematic error,

$N_{ii}, N_{jj}, N_{kk}, N_{ll}, N_{mm}$: sub-set of N_i, \dots, N_m
 $(N_{i1} + N_{i2} + \dots + N_{iI_i} = N_i, \text{ etc.}),$

$l_i = 1,$

$l_j =$ number of samples on which element factor is based,

$l_k =$ number of analytical determinations on which element factor is

- based,
- l_{ℓ} = number of samples on which isotope factor is based,
- l_m = number of analytical determination on which isotope factor is based,
- S_n = \pm w p t ; + : input stream or initial inventory,
- : output stream or final inventory.

In this calculation, the variance is derived from the elements ($C_{\delta i}$, ..., C_{vm}) associated with specific operation for bulk measurement, sampling for element, analysis for element, sampling for isotope, and analysis for isotope.

(3) CUMUF

A 'CUMUF' is an abbreviation of 'Cumulative MUF'. In the field of nuclear material management and control, it is the sum of successive material balances or MUFs, computed after each material balance is closed. In general, the summation can be initiated from an arbitrary starting point, e.g., j, and continued to some succeeding arbitrary ending point, e.g., k:

$$(\text{CUMUF})_j^k = \sum_{i=1}^k (\text{MB})_i \quad (5.6)$$

The variance of CUMUF is a complex combination of the variances of individual material balances, as these balances usually are not independent. Therefore the CUMUF variance also is similarly derived from the elements ($C_{\delta i}$, ..., C_{vm}) associated with specific operation for bulk measurement, sampling for element, and analysis for element through n material balances since the beginning of the accounting period.

(4) Specific treatments for DYSAS-R

The flow simulation code DYSAS-R simulates both discrete events and continuous conditions. Accounting information on receipts at the accountability vessel and shipments at the reception vessel are obtained from the flow simulation data generated by DYSAS-R.

Two types of transfer measurements are considered in this code. These are followings:

a) Measurement of Input or Output Batch

In an accountability vessel, volume measurements and sample takings are made at time points, t_1 and t_2 (Fig. 5.1), and the quantity of an input to or output from the process MBA in the measurement simulation is calculated by

$$\text{Input (or Output)} = V(t_1) \times C(t_1) - V(t_2) \times C(t_2),$$

Where V and C are volume and concentration, respectively. In the actual measurement procedure, however, the quantity input or output is calculated by

$$\text{Input (or Output)} = (V(t_1) - V(t_2)) \times C(t_1)$$

and used as formal accountancy data.

The measured values of $C(t_1)$ and $C(t_2)$ may be different, but $C(t_2)$ is used only for monitoring purpose.

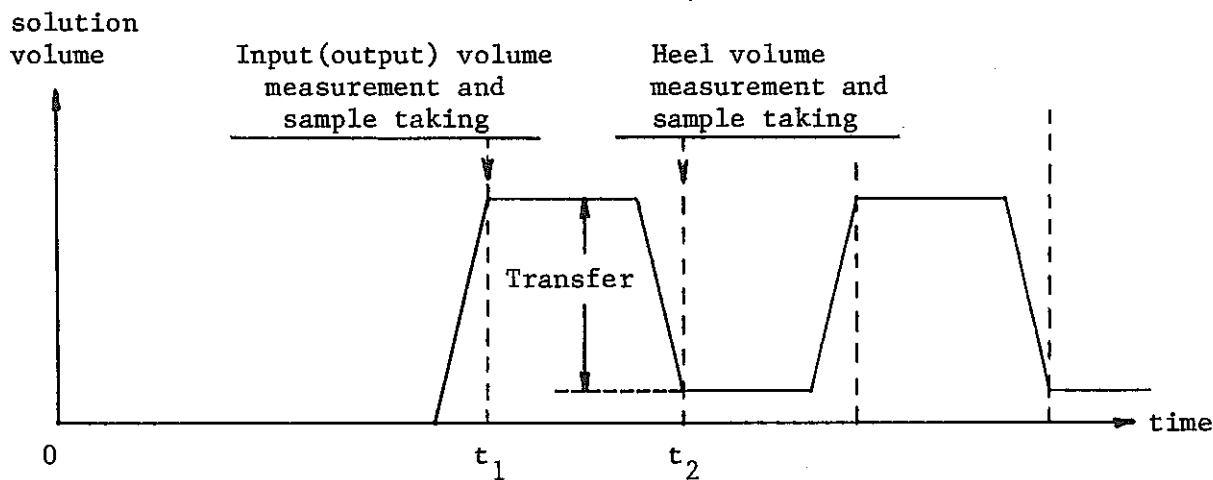

Fig. 5.1 Volume measurements and sample takings used to determine a batch for transfer

b) Measurement of Continuous Transfer

In a continuous process, a quantity of transfer from t_1 to t_2 is calculated approximately by Eq.(5.7).

$$(\text{Transfer from } t_1 \text{ to } t_2) = \int_{t_1}^{t_2} F \cdot C \, dt = \frac{\sum_{i=1}^{n-1} (F_i C_i + F_{i+1} C_{i+1})}{2} \Delta t \quad \dots (5.7)$$

where

- F_i = volumetric flow rate at time t_i ,
 C_i = concentration at the time t_i , and
 i = time point ($i=1 \sim n$)

5.1.3 Analysis of Accountancy data

Analysis of accountancy data for the purpose of timely detection of possible nuclear material loss or diversion is one of the major functions of the materials accountancy system. Decision analysis techniques have been developed in order to detect both short-term loss or abrupt diversion and long-term loss or protracted diversion.

The main goals of decision analysis are

- (a) detection of the event(s) that nuclear material has been lost or diverted,
- (b) estimation of the amount lost or diverted, and
- (c) determination of the significance of the estimates.

The statistical evaluation methodology (decision analysis) for accountancy data is essentially that developed at Los Alamos National Laboratory. JAERI has developed a computer code "SADAC" (Safeguards Data Analysis Code) using this methodology and adding some modifications.

The decision analysis algorithms are applied for the accounting data generated by SIMAC, and the result, i.e., sequential decisions, are graphically expressed in a form of alarm sequence chart.

The present version of SADAC includes CUMUF test based on the cumulative sum of MUF (CUMUF), uniform diversion test based on estimated average loss by Kalman filter and Wilcoxon rank sum test as a non-parametric test. Results of these tests are always expressed in the form of alarm sequence charts.

a) CUMUF

The CUMUF test is a sequentially applied single period test using CUMUF and its variance. The variance is calculated in accordance with the

model described in previous section.

b) Uniform diversion test

This test is a sensitive test when a would-be diverter follows the nominally optimum strategy of diverting a uniformly small amount during each material balance period. In the uniform diversion test there are two different types depending on the difference in the loss estimation method. The test is carried out using an average loss of each material balance period and its variance, estimated by one-state Kalman filter or two-state Kalman filter.

One-state Kalman filter estimate can be shown to be optimal, if the inventory measurement errors are small compared to those of the transfer. If this assumption is not valid, the two-state Kalman filter which estimates both the average loss and the inventory is valid. The two-state Kalman filter is more sensitive than the one-state Kalman filter because the former yields an average loss estimate having smaller variance than the latter.

c) Wilcoxon Rank sum test

Wilcoxon Rank sum test is one of the nonparametric tests, and it is used when the measurement error statistics are unknown or non-Gaussian, and carried out using Rank sum that is a sum of ranks of material balances.

5.1.4 Expression of Decision Analysis

— False Alarm Chart —

As described in the report(3), the decision tests examine all possible, contiguous sub-sequences of the available material balance data and are performed at several levels of significance. The alarm-sequence chart is a graphical display indicating those sequences that cause alarms, specifying each by its length, time of occurrence, and significance. This is a type of pattern recognition device for summarizing the results of the various tests and for identifying trends.

The alarm sequence chart is a point plot of r_1 vs r_2 for each sequence that caused an alarm, with the significance range of each point indicated

by the plotting symbol. A pair of integers (r_1, r_2) are, respectively, the indexes of the initial and final material balances in the sequence. The correspondence of plotting symbol to significance is given in Table 5.1.

Table 5.1 Alarm Classification for the Alarm-Sequence Chart

Classification (Plotting Symbol)		False-Alarm Probability	
A	1	10^{-2}	to 5×10^{-3}
B	2	5×10^{-3}	to 10^{-3}
C	3	10^{-3}	to 5×10^{-4}
if D	if 4	5×10^{-4}	to 10^{-4}
MUF ≥ 0 E	MUF ≤ 0 5	10^{-4}	to 10^{-5}
F	6	10^{-5}	to 5×10^{-8}
G	7	<	10^{-8}
T	T	\sim	0.5

The symbol T denotes sequences of such low significance that it would be fruitless to examine extensions of those sequences: the letter T indicates their termination points.

To explain these procedures using Fig. 5.3.3, consider a sequence of material balance data beginning at balance number 3. The CUMUF test gives an alarm with a false-alarm probability between 10^{-2} and 5×10^{-3} at balance number 8, and the letter A appears at the point (3, 8). This procedure continues for all possible sub-sequences of the available material balances.

In these charts, the alarm-sequence chart for a sequence beginning at balance number 1 is less meaningful because this chart is constructed including the first value of MUF which includes the unmeasured inprocess inventory as a missing amount.

Fig. 5.3.4 shows Kalman filter estimates of average missing material for the case S.S.1-1 with no diversion and with diversion of the amount of 4.742 kgs Pu.

The Kalman filter estimates the average amount of the material missing from each material balance, and the standard deviation of the Kalman filter estimates is taken as $1 \cdot \sigma$ error in the estimate of the average.

Thus the Kalman filter estimates should be the estimate for the actual diversion rate if diversion was occurring. In the case S.S.1-1, the diversion rate assumed is 4.742 kgs Pu per 19 material balances, and therefore the diversion rate is $4.742/19 = 0.250$ kg Pu per n.r.t. material balance period. These figures are listed in Table 5.13. In this case, the Kalman filter estimate is 0.236 kg Pu. This is a fairly good estimate.

Fig. 5.2.5 shows that the alarm-sequence chart for the Kalman filter estimates of the case S.S.1-1. The lower half of Fig. 5.2.5 (case of uniform diversion) clearly shows occurrences of diversion, while the upper half of the same figure (case of no diversion) shows no occurrence of diversion, but the last two material-balance-data points, i.e., 18th and 19th data show an apparent gain of nuclear material. These two points result from the appearance of the unmeasured in-process inventory, as a result of a clean-out physical inventory taking. The quantity of this unmeasured inventory must correspond with what had appeared as a positive MUF value(s) in the early or probably initial n.r.t. material balance(s).

The sequential decision procedure adopted in SADAC includes some addition to the original one described above. These additions are as follows;

- (1) SADAC tests against both gain and loss, and it indicates an alphabetical symbol if the material unbalance is positive, while indicates a numerical symbol if the unbalance is negative.
- (2) When a decision test obtains a result with a false alarm probability greater than 0.5 at the first point of a sub-sequence, i.e., at the point of $\{(r_1, r_2) \mid r_1 = r_2\}$, the decision test indicates the symbol 'T' at this point on the alarm-sequence chart and is terminated immediately in the original decision test procedure. On the contrary, in SADAC, the decision test continues examination of the subsequent material balance data so long as the false-alarm probabilities of succeeding tests continues to decrease.

5.2 Assumptions and Conditions in Simulation Studies

A wide variety of simulated cases have been studied in order to obtain quantitative information with regard to the detection sensitivity of the proposed near-real-time materials accountancy system. Each of these cases is characterized by a combination of the followings:

- (a) plant operating mode (schedule)

- (b) fuel type processed
- (c) measurement methods and measurement accuracies
- (d) measurement equipment recalibration frequency
- (e) n.r.t. accountancy material balance period
- (f) method of in-process inventory taking, and
- (g) diversion mode.

The combination of plant operating mode and fuel type processed is called 'Simulation Study case', and abbreviated by 'S.S.'.

5.2.1 Plant operating mode

Plant operating modes which were selected for this study are summarized in Table 5.2 and described in the following.

- mode 1 : 250 fuel batches are processed during 5 months, then a clean-out is performed and a static physical inventory is taken. The conventional material balance period (from one clean-out PIT to the next one) is six months.
- mode 2 : The conventional material balance period is six months but only 234 spent fuel batches are processed. First 120 batches (in 70 days) are processed and then a flush-out operation is carried out for 10 days. After that, the plant is operated an additional 70 days and then a clean-out physical inventory is taken.
- mode 3 : The conventional material balance period is six months as in modes 1 and 2, but it includes three ten-day-flush-outs in a 5 month processing run. There are 202 batches. This operation mode is the most complicated one studied.
- mode 4 : A total of 146 batches of fuel are processed in 90 days. After clean-out a static PIT is carried out. The conventional material balance period is four months.
- mode 5 : The conventional material balance period is four months as in operation mode 4. A total of 130 fuel batches are processed in 90 days, interrupted by a 10-day-flush-out after 45 days.
- mode 6 : This case is a special one in which a continuous processing run of ten months or more occurs. Fuel processed in this 10 months totals 500 batches.

mode 7 : This operating mode is an 8 months simulation case which consists of operation mode 4 repeated twice. An operating period of this mode includes two PIT's, and 292 batches are processed.

mode 8 : This operating mode is an 8 months simulation case as in operation mode 7, and consists of two periods of operating mode 5. There are two PIT's, and 260 batches of fuel are processed in this period.

5.2.2 Fuel type processed

As shown in Table 5.3, types of spent fuel processed are those from BWR and PWR reactors, and three levels of burn-up, i.e., minimum, average, and maximum, are assumed to be 10,000, 15,000, and 20,000 MWD/MT for BWR fuels, and 10,000, 20,000, and 27,500 MWD/MT for PWR fuels, respectively. Since dissolution rate is determined primarily by achievable uranium concentrations, these differences relate to variations in plutonium feed rate.

5.2.3 Measurement methods and measurement accuracies

The measurement methods and measurement accuracies are assumed to be as shown in Tables 5.4 and 5.5. These tables are quoted from the document presented to the Advisory Group Meeting on Safeguarding Reprocessing Plants, held on June, 1978 at Vienna. The major difference between the two tables is in the short-term systematic errors. In Table 5.4, figures nearly equal to long-term-systematic errors are listed as short-term systematic errors. Table 5.5 in general assigns smaller figures than those in Table 5.4.

In addition, the use of NDA technology for analysis at the in-process inventory, D_1 (feeding vessel) is also investigated. In this case, measurement accuracies are assumed to be 20 percent for random component, and 10 percent, 0.5 percent for short-term and long-term systematic error components, respectively.

5.2.4 Measurement equipment recalibration frequency

As shown in Table 5.3, three types of recalibration frequency are

considered. These are weekly, tri-weekly and monthly recalibration. Recalibrations with these frequencies are applied only for the analytical procedures. For volume measurement and sampling for analysis, recalibration will be carried out once or twice per year. It is assumed that volume recalibrations are not done during the simulated period (4 months ~ 10 months).

5.2.5 N.R.T. accountancy material balance period

Simulations of different n.r.t. accountancy material balance periods, that is the interval between successive in-process physical inventories, were carried out. These simulated periods are 7 days, which is a principal assumption in the "ten-day-detection-time model", 14 days and 3 days.

The timing of the n.r.t. accountancy physical inventory is set as a time point when the Pu evaporator is discharged. Therefore an interval between in-process PIT's is not always 7, 14 or 3 days exactly. In the simulation for the case of 7 days, for example, the in-process PIT is carried out on a time point later but nearest to 7 days after the preceding in-process PIT. Therefore the simulated time intervals for an in-process PIT may fluctuate around the settled time interval.

5.2.6 Method of in-process physical inventory taking

In-process physical inventories in the "ten-day-detection-time model" are applied for the input accountability vessel and the product accountability vessel as formal key measurement points, plus four major vessels (named as Partial PIT in this report). Another in-process physical inventory method in which the estimated or calculated inventories in mixer-settlers and other small vessels are added to the actual measured inventories is considered (named as full PIT in this report). In this case, three types of random error associated with estimation of each inventory are assumed. These values are 5, 10, and 20 percent for vessels, mexer-settlers, and other small vessels, respectively.

5.2.7 Diversion mode

Three patterns of diversion mode, i.e. "single diversion" (the single removal of a relatively large quantity of plutonium), "uniform diversion"

(the continuous and constant removal of a small amount of plutonium over a long period), and "random diversion" (intermediate of the other two modes, involving random removals equivalent in total amount to patterns) are considered.

Assumed amounts of diversion are nearly equal to $\sigma_{\text{MUFd}}/\text{DMBP}$, $1.5\sigma_{\text{MUFd}}/\text{DMBP}$, $0.25\sigma_{\text{MUFd}}/\text{DMBP}$ (corresponding to 4.4 kg \sim 10.3 kg Pu per conventional material balance period) and 8 kg Pu per year, where σ_{MUFd} is the standard deviation of an in-process MUF, and DMBP is an n.r.t. material balance period. The simulated cases studied are shown in Table 5.6. Details for each of the simulations are described below.

- a) In cases S.S.1-1 through S.S.1-6, the influences of different types of processed fuel on near-real-time materials accountancy are investigated. In all cases a single operation mode of mode 1 is assumed, but the type of fuel changes from type 1 to type 6 for each simulation study.
- b) In cases S.S.1-7 through S.S.1-10, the effectiveness of near-real-time materials accountancy under different operating modes is investigated. In all cases a single fuel type, i.e., PWR type fuel with 20,000 MWD/T burn-up, is assumed, but the operating mode changes from type 2 to type 5 for each simulation study.
- c) S.S.1-5-2 is performed to study the sensitivity against a small continuous diversion. In this case, PWR type fuels are assumed to be processed continuously during 10 months.
- d) S.S.4 is the most complicated case in this simulation study. Four 30-day processing runs followed by a 10-day-flush-out are repeated three times in 4 months, and then a 30-day processing run followed by a 30-day PIT is carried out within a 6 months-conventional material balance period. Three types of PWR fuels of different burn-up are exchanged for each 10 days. Processed fuel types are sequentially exchanged as follows.

Fuel type 4 \rightarrow 5 \rightarrow 6 \rightarrow 5 \rightarrow 6 \rightarrow 4 \rightarrow 6 \rightarrow 4 \rightarrow 5 \rightarrow 4 \rightarrow 5 \rightarrow 6

- e) S.S.1-9-2 and S.S.1-10-2 are carried out in order to study and evaluate the influence of interrupting a continuous operation with two or more conventional PIT's. An operation of 4 months-material balance period is repeated twice. This simulation thus covers 8 months.

True material balances for each case, obtained from flow simulations, are shown in Table 5.7. The figures in this table include no measurement

error.

5.3 Performance of Materials Accountancy under Normal Operating Conditions

5.3.1 Fluctuation of the unmeasured in-process plutonium holdups

As previously described, the success of the near-real-time materials accountancy based on 'ten-day-detection-time model' will depend upon whether or not fluctuations in the unmeasured in-process inventory can be limited within an acceptable level in comparison with a magnitude of MUF_d in a specified period of time. Table 5.9(1 ~ 6) shows simulated data for plutonium concentration and holdup in each unit process for cases S.S.1-1 through S.S.1-6. These values do not represent average values during the equilibrium state but represent individual values at some particular point of time in the equilibrium state. From these tables mean values of Pu-holdups and fluctuations among cases can be calculated for each process unit.

On the other hand, fluctuations with time in the in-process Pu-holdup can also be examined by comparing S.S.1-8 and S.S.4. The only difference between these cases is the input fuel type; that is, in the former case, input fuel is only one fuel type (No.5), while three types of fuels are sequentially chosen as input fuel in the latter case. The operating mode of these cases are the No.3 operating mode, which corresponds to the most frequent flush-out operations conceivable in an actual situation. The values of the fluctuations of these two kinds are shown in Table 5.8.

Table 5.8 In-process Inventory Fluctuation

Process Unit		Average holdup	Fluctuation among cases	Fluctuation with time	
No.	Name			Case S.S.1-8	Case S.S.4
5	Extraction-I	495 g Pu	392 g Pu	10 g Pu	350 g Pu
6	Extraction-II	73	58	2	53
7	Adjusting vessel	29	23	1	21
9	Extraction-III	363	287	8	260
10	Extraction-IV	245	192	7	180
11	Adjusting vessel	88	70	3	60
13	Oxidation column	108	87	3	75
14	Extraction-VIII	349	279	8	250
15	Extraction-IX	203	163	8	140

These fluctuations in each unit process, however, cannot be used to estimate the total fluctuation of the unmeasured in-process Pu-holdup in the whole material balance area. From the results of flow-simulations for cases S.S.1-8 and S.S.4, the total fluctuation of unmeasured in-process holdups are estimated as follows;

<u>Case</u>		
S.S.1-8	maximum Pu-holdup	2.423 kgs
	minimum Pu-holdup	2.395 kgs
	<hr/>	
	maximum fluctuation	0.028 kg
S.S.4	maximum Pu-holdup	2.872 kgs
	minimum Pu-holdup	1.530 kgs
	<hr/>	
	maximum fluctuation	1.342 kgs

As described in Section 4.4, our preliminary study suggested that it would be desirable to restrain the fluctuation below about 200 grams Pu. This figure had been derived from the expected value of σ_{MUF_d} . From this point of view, special operating modes such as S.S.4 should be avoided in case of near-real-time materials accountancy based upon 'ten-day-detection-time model'. Otherwise, a more precise n.r.t. accounting procedure must be considered. An alternative is adoption of a dynamic simulation of mixer-settler inventories, and inclusion of the estimate in the dynamic material balance equation.

As shown later, σ_{MUF_d} is in the range 260 grams to 517 grams depending upon characteristics of campaigns. Normal fluctuations of the unmeasured in-process holdup might be neglected in comparison with the values of MUF_d .

It can be concluded, therefore, that the magnitude of fluctuation of the unmeasured in-process Pu-holdup is not so significant as to affect the effectiveness of the proposed near-real-time materials accountancy, so long as normal operations are assured by some other methods, for example, by input batch preparation control using calculated burnup data.

5.3.2 Measurement accuracies

Table 5.11 shows simulated values of MUF_d and σ_{MUF_d} for S.S.1-8 and

S.S.4. These cases were selected because they showed the greatest difference among the simulated cases. Table 5.12 (1 ~ 2) gives MUF_d , σ_{MUFd} , CUMUF and σ_{CUMUF} for the case of no diversion of S.S.1-5-1. This table indicates the influence of different measurement accuracies on the total uncertainty of the material balance, i.e., σ_{MUFd} or σ_{CUMUF} . From these tables the following conclusions are obtained.

- (a) If the measurements are performed with the accuracies listed in Table 5.5, the standard deviation of MUF_d (σ_{MUFd}) becomes about one third of that which could be obtained when the measurements are combined with the errors in Table 5.4. The major reason of this is the differences in systematic errors.
- (b) In the actual designing of the near-real-time materials accountancy, it will be expected that load cell equipment will be utilized for weighing purposes. In such a case, accuracies to be assigned to a load cell are expected to be those in Table 5.5. These values may be occasionally quite similar to those in Table 5.4, which are used as standard values in our simulation studies.
- (c) The measurement accuracies on the in-process physical inventory takings have little effect in the standard deviation of MUF_d , because total throughput is much greater than the inventory in case of a weekly material balance period.
- (d) It must be noted that the value of MUF_d of the first material balance includes unmeasured in-process inventory. This is in the range of 1.349 kg Pu (S.S.1-1) to 3.263 kg Pu (S.S.1-6). In Table 5.11, this is 2.704 kg for S.S.1-8 and 1.726 kg for S.S.4.
- (e) It is better to select an instrument with small systematic error in the measurements for the near-real-time materials accountancy. An application of an instrument with high accuracy to the in-process inventory taking is not expected to reduce the σ_{MUFd} in such a plant as the inventory is much smaller than the throughput.

Values of σ_{MUFd} vary from period to period of near-real-time material balances, depending upon characteristics of campaigns. For the purpose to comparing material accountancy in each case, it is convenient to use approximate averaged values of σ_{MUFd} . Table 5.10 shows a simple algebraic mean of σ_{MUFd} 's in the formal material balance for each simulation cases.

Table 5.10 Simple algebraic mean of σ_{MUF_d}

<u>Case</u>	<u>σ_{MUF_d}</u>
S.S.1-1	224 g Pu
S.S.1-2	294
S.S.1-3	354
S.S.1-4	267
S.S.1-5	417
S.S.1-6	506
S.S.1-7	399*
S.S.1-8	433*
S.S.1-9	383
S.S.1-10	361
<hr/>	
S.S.2-1	417
S.S.2-2	401
S.S.2-3	133
S.S.2-4	126
<hr/>	
S.S.3-1	406
S.S.3-2	417
S.S.3-3	421
S.S.3-4	420
<hr/>	
S.S.4	404*

The values with asterisk in the table should be directly compared with the values of fluctuations of unmeasured in-process Pu holdup in the whole area in MBA 2.

Influence of the variation of input spent fuel upon the accountability, i.e., σ_{MUF_d} , are summarized in Table 5.11. As previously noted, S.S.1-8 and S.S.4 are the cases which most amplify such influences. The Table shows, however, the influence on σ_{MUF_d} is quite small or rather negligible. Small differences can be seen in σ_{CUMUF} , but this difference seems to result from the difference in throughputs, i.e., 614 kg Pu for S.S.1-8 and 577 kg Pu for S.S.4.

5.3.3 Frequency of Calibration

Table 5.13(1 ~ 3) gives the MUF_d , σ_{MUF_d} , CUMUF and σ_{CUMUF} for the once per week, once per three weeks and once per month of the frequency of calibration in the cases of no diversion for S.S.1-5-1, S.S.1-8 and S.S.4. The average MUF_d , $\overline{\text{MUF}_d}$ and CUMUF have a maximum value with a frequency of calibration of once per three weeks and a minimum value for that of once a month for each of three cases. This happened by chance because a series of

random numbers were used for the simulation.

The σ_{MUFd} is not sensitive to frequency of calibration. This is due to the short, just one week, near-real-time material balance period. For a longer material balance period, the longer the calibration interval, the greater the σ_{MUFd} will be. As for σ_{CUMUF} , the longer the interval, the greater the value is. Since the test of detection of diversion is carried out based on CUMUF, it is desirable to calibrate the instruments as frequently as possible if the cost and manpower for the calibration is available.

5.3.4 Contribution of Error Components to σ_{CUMUF}

In order to look into the contribution of error components to the σ_{CUMUF} , a component of σ_{CUMUF} and its ratio to the total σ_{CUMUF} were calculated for each error component in the case of no diversion for S.S.1-5-1. Tables 5.14(1 ~ 2) give the variances of CUMUF's for ten consecutive material balance periods from the beginning of the campaign and a σ_{CUMUF} for the 20th material balance period, which overlaps the clean-out operation, under the normal operating condition. The following points are obvious from this table:

- (1) A great portion of σ_{CUMUF} comes from the errors of input and product measurements. It amounts to 99.6 % for the periods under a continuous operating condition and reaches to 99.9 % for the period which ends at the clean-out. This occurs due to the much larger amounts of throughput than inventory.
- (2) The contribution of error of input measurement is 70 % to the total. As for the type of measurement, the biggest contributor is the long term systematic error of chemical analysis occupying a quarter of the total. The systematic error component is similarly big for the bulk measurement, i.e. volume and concentration measurements, and for the sampling. In order to reduce the magnitude of σ_{CUMUF} , it is necessary to reduce the long term systematic error. If the long term systematic error of bulk measurement, for example, can be reduced to a third of the given value, i.e. from 0.3 % to 0.1 %, its variance is decreased from a significant value of 5.1846 kg² to one ninth of that, 0.5761 kg², a value that is no longer of great importance.

5.4 Diversion Sensitivity Analyses

For diversion sensitivity analyses a material balance chart, a CUMUF and its alarm sequence chart, and an average loss of nuclear material estimated by the two state Kalman filter and its alarm sequence chart were produced under each of the following conditions, as shown in Figs. 5.2 to 5.52.

- (1) A uniform diversion of about $1\sigma_{\text{MUFd}}$ per DMBP, in the cases of S.S.1-1 to S.S.1-10, shown in Figs. 5.2 to 5.6.
- (2) A uniform diversion, of about $1\sigma_{\text{MUFd}}$, around 8 kg Pu, per TMBP or 8 kg Pu per year in the cases of S.S.1-5, S.S.1-7 to S.S.1-10 and S.S.4, shown in Figs. 5.7 to 5.12.
- (3) No diversion or a uniform, random or single diversion, of 8 kg Pu per year or 8 kg Pu per TMBP in the cases of S.S.1-5-1, S.S.1-8 and S.S.4 with a near-real-time material balance period (NRTMBP) of the model-used seven days or special fourteen or three days, shown in Figs. 5.13 to 5.33.
- (4) An NRTMBP of seven, fourteen or three days, or use of a nondestructive analysis for measurement of the feeding vessel, both in the case of S.S.1-5-2, shown in Fig. 5.34.
- (5) A uniform diversion of 8 kg Pu per year in the cases of S.S.1-7, S.S.1-8, S.S.1-10 and S.S.4 where a more complete physical inventory is taken by measuring the inventory of mixer settler systems and other normally unmeasured vessels with an accuracy of 20 %, 10 % or 5 %, shown in Figs. 5.35 to 5.42.
- (6) A uniform, random or single diversion of 8 kg Pu per year in the cases of S.S.1-5-1, S.S.1-8 and S.S.4 with NDA measurements being used for the analysis of the feeding vessel, shown in Figs. 5.43 to 5.48.
- (7) No diversion or a uniform diversion of 8 kg Pu per year in the cases of S.S.1-9-2 and S.S.1-10-2 where the NRTMBP is seven days and the unmeasured inventory is estimated by two different methods, shown in Figs. 5.49 to 5.52.

5.4.1 General Consideration

a) Material Balance (Shewhart) Chart

The Material Balance (Shewhart) Chart is a figure in which the MUFd is plotted with an error bar of its standard deviation, σ_{MUFd} , for all the material balance periods concerned.

In the present model of ten days detection time, some in-process inventory is not measured, affecting the magnitudes of MUFd. As a matter of fact the changes of this unmeasured inventory from NRTMBP to NRTMBP are a component of MUFd. As mentioned before and as shown in the material balance chart of Fig. 5.2 or in other cases except for a complete IPIT, a MUFd of the NRTMBP just after the startup of a campaign, before or after a flush-out, or at a clean-out is relatively large in absolute value due to the changes of unmeasured inventory.

In the case of a uniform diversion, an MUF with a positive value appears more often than in the case of no diversion. This means that a positive bias exists. It is not possible, however, to detect the uniform diversion if the LEMUF is used with the MUF for testing.

In the case of an abrupt diversion, the amount of MUF clearly increases in the NRTMBP during which an abrupt diversion has been attempted. If a large amount is diverted, it is possible to detect such a diversion using the LEMUF. Otherwise, however, the MUF is regarded as not being significant from the view point of statistics.

The material balance chart is useful to verify a diversion which has been detected using other techniques and, especially in the case of abrupt or random diversion, to investigate the period during which the diversion has occurred, because the chart gives an overview of the dynamic material balances over the campaign.

b) CUMUF Chart and Corresponding Alarm Chart

The CUMUF Chart is a figure in which a cumulative MUF (CUMUF) is plotted with an error bar of its standard deviation, σ_{CUMUF} , and the corresponding Alarm Chart is one to show a conclusion of the decision test.

Although the CUMUF is affected by the unmeasured inventory, it approaches to zero in the case of no diversion of a clean-out PIT is carried out because the initially built-up unmeasured inventory is recovered and measured. Since the CUMUF uses an accumulated MUF, it becomes easier to detect diversions that the material balance chart cannot recognize, especially a protracted diversion. The case of S.S.1-1 in Fig. 5.2, for example, shows that the CUMUF is constantly increasing its value, but this is not obvious if only the material balance chart is used for the diversion analyses. Other cases, too, give the same conclusion as this example.

c) Estimation of Average Loss by Kalman Filter and Corresponding Alarm Chart

The Average Loss Chart is a figure in which an average loss of nuclear material estimated by Kalman filter is plotted with an error bar of its estimated standard deviation, σ_{AL} , and the corresponding Alarm Chart is one to show a conclusion of the decision test using the average loss chart.

Table 5.16 gives in the case of uniform diversion an amount of diversion over a static, or traditional, material balance period, a static MUF, i.e. CUMUF, a NRTMBP-averaged amount of diversion which is calculated by dividing the total amount of diversion into the number of NRTMBPs during the TMBP, and an average loss estimated by both one state and two state Kalman filters over all the NRTMBPs except for the first NRTMBP and the last NRTMBP.

Consulting this table, all CUMUF's are greater than the amounts diverted, showing a bias with a positive value. This has been caused by a long term systematic error which was generated by a random number generator for the measurement simulation. This tendency of the CUMUF is not changed in the case of no diversion.

The predicted average loss is a good estimate for both Kalman filters compared with the average amount of diversion per DMBP if the cases of S.S.8 and S.S.4 are excluded. These two cases, however, have a flush-out operation in the period concerned and, in S.S.4, the type of fuel to be processed is changed twice, resulting in a large amount of variation of the inventory and throughput. This seems to be the reason for the predicted average loss not being a good estimate of the actual loss.

In comparing both Kalman filters, the two state Kalman filter has a smaller estimated standard deviation than the other. Since it has been cleared by the feasibility study carried out until now that the two state Kalman filter has a better sensitivity of detection against a diversion than the one state Kalman filter, then only the former's results are shown in the figures for this section.

d) False Alarm against no Diversion : Noise in Decision Analysis

As mentioned before, a false alarm sometimes appears due to variations of the unmeasured inventory in the case of no diversion. Since all the unmeasured inventory is accounted as an MUF with a positive value during

the first NRTMBP just after the clean-out operation, a false alarm can be seen at the first row of the initial point in the case of S.S.1-1 as shown in Fig. 5.3. On the other hand, the unmeasured inventory is accounted as an MUF with a negative value at the clean-out because it is not contained in the beginning inventory but is measured as an output at the final stage of the NRTMBP. Therefore a false alarm that shows a negative bias can be seen at the 18th column of the ending point in the same figure. If an in-process inventory is carried out at the clean-out, a false alarm sometimes can be seen over two columns as shown at the alarm chart of S.S.1-4 in Fig. 5.3.

As for the flush-out, a false alarm can be seen in S.S.1-7 of Fig. 5.5. Comparing the alarm charts between the CUMUF and the Kalman filter in this Figure, an alarm "A" is found at the point (10,11) in the CUMUF but the alarms can be seen in the Kalman filter on a squared region bounded by the first and tenth rows to the initial point and by tenth and eighteenth columns to the ending point. This is caused by the MUF of about 1 kg which accompanied the flush-out. In the case of the Kalman filter, a variation of unmeasured inventory that occurs only in one DMBP is propagating over a longer periods with generating alarms because the average loss is estimated nearly over the TMBP. This situation will be the same in the cases of S.S.1-8, S.S.1-10 and S.S.4 which contain a flush-out. No alarms, however, can be seen in the case of no diversion. This difference arises because, in S.S.1-7, an in-process inventory was by chance carried out during the flush-out. In the other cases this did not occur, resulting in reducing the impact of the flush-out on the statistics.

S.S.1-7		1648h	1838h	3393h	4320h		
		Flush-out			Clean-out		
		Δ	Δ	Δ	Δ	Δ	
in-process		#9	#10	#11	#19	#20	
PIT		1512h	1686h	1881h	3368h	4222h	

S.S.1-8		735h	908h	1619h	1784h	2491h	2660h	3382h	4320h
		Flush-out		Flush-out		Flush-out		Clean-out	
		Δ	Δ	Δ	Δ	Δ	Δ	Δ	Δ
in-process		#5	#6	#9	#10	#13	#14	#17	#18
PIT		728h	956h	1477h	1840h	2387h	2721h	3386h	4221h

If a three day NRTMBP period is used, a false alarm occurs more often because in-process inventories are more frequently carried out during the

flush-out.

It happens sometimes that a false alarm is recognized in the case of the type of fuel being changed during a campaign as in S.S.4.

5.4.2 Sensitivity against each Diversion Mode

a) Uniform Diversion

As shown in Table 5.16, it is not possible to detect the uniformly diverted amount of nuclear material that has been assumed in this study if the LEMUF method, in which an MUF is compared with $2\sigma_{\text{MUF}}$, is used in the same manner as the traditional materials accountancy. However, a small amount of uniform diversion, e.g. 115 g to 665 g per NRTMBP, can be detected if n.r.t. materials accountancy is applied to the plant.

Table 5.17 shows the first alarm or false alarm point with regard to the uniform diversion. This table also gives the operation mode so as to be able to investigate a cause of the false alarm. Consulting this table, diversion detection is not successful against a diversion of 8 kg Pu per year in the cases of S.S.1-9, S.S.1-10 and S.S.1-10-2 where a TMBP is four months. The simulation conditions of S.S.1-9-2 are the same as those of S.S.1-9 except for the period covered by the simulation, which is twice longer, and for the diversion ratio of 227 g per NRTMBP instead of 223 g per NRTMBP in S.S.1-9. This slight difference makes it possible for the diversion in S.S.1-9-2 to be detected by a NRTMBP during the first TMBP.

Since these undetected cases have only a shorter TMBP with a slightly different diversion ratio, it is expected that the diversion should be detectable if the simulation period is extended. As shown in S.S.1-10-2, however, this is not true unless the unmeasured inventory is taken into consideration because the unmeasured inventory during the NRTMBP which overlaps the clean-out gives an enormous noise effect to the detection sensitivity. This topic is discussed later. In general, the greater the diversion ratio, the shorter is the interval from the starting point of diversion until the time of detection.

b) Random Diversion

All cases of the random diversion assumed in this study are detectable. In the case of an amount of $1\sigma_{\text{MUFd}}$ being diverted, an alarm

sign is produced at the point of diversion almost all the times. The MUFd is also bigger at the NRTMBP during which the diversion has been attempted and, in some cases, it is bigger than the limit of error, $2\sigma_{\text{MUFd}}$, used in the LEMUF method. In the case of a diversion of 8 kg per year, the detection points are not many as a matter of course and the MUFd's are less than $2\sigma_{\text{MUFd}}$ in almost all the cases.

c) Single Diversion

In the case of single diversion, the MUF is greater than $2\sigma_{\text{MUFd}}$ at the diversion point for both cases of a diversion of $1\sigma_{\text{MUFd}}$ per NRTMBP and 8 kg per year. The CUMUF chart also shows a sharp increase of the CUMUF at the diversion point. All cases assumed in the study are detectable.

5.4.3 Effect of the Length of a NRTMBP

Table 5.18(1 ~ 2) shows an alarm point for a different length of NRTMBP. It also gives the operating mode and the diversion point in the case of a random or single diversion.

Comparing the case of the NRTMBP of 14 days with that of 7 days, a diversion of $1\sigma_{\text{MUFd}}$ is also detectable in all cases but, as to the uniform diversion, detection is delayed and, as for the random diversion, the number of detection points is smaller. On the other hand, the length of NRTMBP does not drastically affect the detection of diversion with regard to the single diversion although the time of detection is shifted a little because the interval between in-process inventories becomes longer. For a diversion of 8 kg per year, it becomes harder to detect the uniform or random diversion. The only detectable uniform diversion case is S.S.4 where an alarm occurs at the period that contains the flush-out. Since no alarm occurs in the case of no diversion, it is considered that the alarm is produced as the results of interaction between the flush-out and the diversion. Since it is, however, an alarm at the time of flush-out, there is a possibility for the alarm to be overlooked. The single diversion is also detectable as well as the diversion of $1\sigma_{\text{MUFd}}$ and the noise level is decreased if the NRTMBP becomes 14 days.

In the case of three days of NRTMBP, a false alarm is more frequently signaled due to the variation of the unmeasured inventory but the detection sensitivity against a diversion becomes good. In this case a variation of

unmeasured inventory due to the change of fuel to be processed, as in S.S.4, is a cause of the false alarm.

As the conclusion, it seems that 14 days period is too long as a NRTMBP and 7 days is the best choice to this model plant if the diversion strategy is assumed as in the study.

5.4.4 Complete In-process Inventory Taking

If it is possible to estimate the inventory in mixer-settler systems and other vessels and pots which have not been included into the dynamic inventory measurement points at the present model, a complete in-process inventory and its corresponding diversion sensitivity analysis could be carried out by adding this inventory to the near-real-time material balance equation. A simulation study has been carried out for the complete in-process inventory and as the results Table 5.19 shows the alarm point or false alarm point. The simulated cases are those of no diversion and a uniform diversion of 8 kg per year in S.S.1-7, S.S.1-8, S.S.1-10, as well as S.S.4 where the variation of unmeasured inventory is large due to the flush-out being contained in the period concerned. In order to make a comparison easy, the long term systematic error has been set to zero.

By doing a complete in-process inventory, a false alarm against no diversion almost disappears and only one or two alarms of level A or level B can be seen in the CUMUF alarm chart. The case of S.S.1-10 is an exception, where noise is found at the NRTMBP of the clean-out in the alarm chart of Kalman filter with -24 g to MUFd and 4.6 g to σ_{MUFd} . This seems to occur because the flow measurement of waste is handled as continuous transfer measurement where the concentration and flow rate are measured for each 8 hours and they are assumed to change linearly between two measuring points.

All diversions except for the case of S.S.1-10 are detected. Since the alarm which has occurred due to the variation of unmeasured inventory now disappears, it is not necessary to determine whether the alarm is signaled due to the diversion or due to the operation. Unless the complete in-process inventory is applied, it is difficult to detect the protracted diversion under an operating mode in which the variation of unmeasured inventory is large.

5.4.5 Application of NDA Measurement to Analysis of Feeding Vessel

Table 5.20 shows the detection point against a uniform, random or single diversion and the false alarm point against no diversion in the cases of S.S.1-5-1, S.S.1-8 and S.S.4 where NDA is used for the measurement of Pu concentration in the feeding vessel. The table shows that all diversion modes are detectable as the results of the simulation. This is due to the small contribution of inventory measurement to the σ_{MUFd} as mentioned before.

5.4.6 Clean-out PIT

The unmeasured inventory gives a big positive MUF to the MUFd at the first NRTMBP after the clean-out. This MUF is detected as an alarm in the alarm sequence chart of the CUMUF and/or the Kalman filter. Especially in the Kalman filter, an alarm is displayed for all points that start just after a clean-out as shown in Figs. 5.49 and 5.51. This means that it is not possible to use the Sequential Probability Ratio Test for the Kalman filter over several TMBPs.

In order to remove the effect of this unmeasured inventory, each n.r.t. inventory except for the clean-out PIT has been increased by the first MUFd after the clean-out, which is an estimate of unmeasured inventory. The results of the simulation on this case show that the noise completely disappears for the CUMUF but it still occurs for the Kalman filter. In the case of S.S.1-9-2, such a procedure cannot delete the MUF with 2 kg of MUF remaining at the tenth NRTMBP because the clean-out PIT has been carried out by chance in the measurement simulation before the clean-out is completely finished. In S.S.1-10, however, no MUF remains because the PIT is done after the clean-out has been finished. This means that the inventory measurement should not be done during the period from the beginning of cleanout until the completion of the clean-out if this procedure has to be applied to remove the effect of unmeasured inventory, and that the first inventory taking after the clean-out should not be done until an equilibrium state being attained. As for the CUMUF, it is found that estimating the unmeasured inventory using this procedure gives a satisfactory result if the time-dependent variation of unmeasured inventory is not large.

If a complete PIT is carried out, it is possible to almost completely delete the noise accompanying the clean-out and to improve the detection sensitivity against a diversion.

Table 5.2 Simulated Operation Modes

Operation Mode No.	Pattern (unit : day)	Number of Dissolver Batches
1		250+ 6+50 Fu C P
2		120+16+114+ 6+50 Fu F Fu C P
3		52+16+52+16+52+16+46+ 6+50 Fu F Fu F Fu F Fu C P
4		146+ 6+50 Fu C P
5		68+16+62+ 6+50 Fu F Fu C P
6		500 Fu
7		146+ 6+50+146+ 6+50 Fu C P Fu C P
8		68+16+62+ 6+50+68+16+62+ 6+50 Fu F Fu C P Fu F Fu C P

Fu : Fuel
 F : Flush-out
 C : Clean-out
 P : PIT (Physical Inventory Taking after Clean-out)

Table 5.3 Assumptions and conditions for Simulation Studies

Fuel Type

Fuel Type	Reactor Type	Burn-up (MWD/MT)	Total Assembly Weight (kg)	Uranium of Fresh Fuel (kg)	Uranium (kg)	Plutonium (kg)
1	BWR	10,000	550.	400.	394.	1.656
2	BWR	15,000	550.	400.	391.2	2.128
3	BWR	20,000	550.	400.	389.2	2.496
4	PWR	10,000	550.	400.	394.	1.968
5	PWR	20,000	550.	400.	388.	3.040
6	PWR	27,500	550.	400.	384.8	3.576

Type of Measurement Error

- 1 Table 5.4 , Case of standard measurement accuracy for in-process inventory taking.
- 2 Table 5.4 , Case of optimistic measurement accuracy for in-process inventory taking.
- 3 Table 5.5 , Case of standard measurement accuracy for in-process inventory taking.
- 4 Table 5.5 , Case of optimistic measurement accuracy for in-process inventory taking.

Type of Recalibration Frequency

- 1 Weekly recalibration
- 2 Tri-Weekly recalibration
- 3 Monthly recalibration

Type of Near-Real-Time Balance Period

- 1 1 week
- 2 2 weeks
- 3 3 days

Type of In-Process Inventory Taking

- 1 Partial PIT
- 2 Full PIT (Estimated Inventory Accuracies are 5,10,20 %)

Table 5.4 Measurement methods and relative percentage standard deviation of a single measurement - (1)

Location	Volume & weight measurement				Analysis for plutonium				Sampling			
	Methods & techniques	Random error	S-S error	L-S error	Methods & techniques	Random error	S-S error	L-S error	Methods & techniques	Random error	S-S error	L-S error
Input accountability vessel	Dip tube	0.4	0.3	0.3	Mass spec.	0.9	0.4	0.4	Vaccum sampling tube	0.4	0.3	-
Waste	Dip tube	3.0	3.0	3.0	Spectro-photometry & α-counting	20.0	5.0	10.0	Vaccum sampling tube	6.0	6.0	-
Product accountability vessel	Dip tube	0.3	0.2	0.2	Titration	0.7	0.7	0.3	Vaccum sampling tube	0.5	0.3	-
Other vessels (feeding, buffer, etc.)		(1.2 2.0)	0.9 1.5	0.9)* 1.5)**		0.9	0.4	0.4		(1.5 2.5)	0.9 1.5	-)* -)**

S-S : Short-term systematic error

L-S : Long-term systematic error

* : Case of optimistic measurement accuracy for in-process inventory taking

** : Case of standard measurement accuracy for in-process inventory taking

Table 5.5 Measurement methods and relative percentage standard deviation of a single measurement - (2)

Location	Volume & weight measurement				Analysis for plutonium				Sampling			
	Methods & techniques	Random error	S-S error	L-S error	Methods & techniques	Random error	S-S error	L-S error	Methods & techniques	Random error	S-S error	L-S error
Input accountability vessel	Electro-manometer	0.2	-	0.01 ⁺	Isotope dilution	0.43	-	0.3	Recirculating sampler	0.15	-	-
	Load cell	0.5	0.3	0.1								
Waste	Electro-manometer	0.3	-	0.2 ⁺	Isotope dilution TTA extraction & N-counting	0.43	-	0.2 ⁺	Recirculating sampler	0.3	-	-
	Load cell	0.5	0.3	0.1								
Product accountability vessel	Electro-manometer	0.1	-	0.05	Amperometric titra. Pu-coulometric Isotope dilution	0.5	0.3	0.2	Recirculating sampler	0.15	-	-
	Weigh scale	0.1	-	0.03 ⁺								
		0.43	-	0.2								
Other vessels (feeding, buffer, etc.)		(0.6	-	0.03) [*]		0.43	-	0.3		(0.45	-	-) [*]
		(1.0	-	0.05) ^{**}						(0.75	-	-) ^{**}

S-S : Short-term systematic error
L-S : Long-term systematic error

* : Case of optimistic measurement accuracy for in-process inventory taking
** : Case of standard measurement accuracy for in-process inventory taking
+ : Used for the simulation study calculation

Table 5.6 Simulation Cases Studied

Simulation Study Case	Operation Mode	Fuel Type	Type of Measurement Error	Type of Recalibration Frequency
S.S.1-1	1	1	1	1
-2		2		
-3		3		
-4		4		
-5-1		5	1/2/3/4	1/2/3
-6		6	1	1
-7	2	5		
-8	3			1/2/3
-9	4			1
-10	5			
-5-2	6			
-9-2	7			
-10-2	8			
S.S.4	3	4/5/6		1/2/3

Table 5.7 Exact Material Balance with and without Diversion

Simulation study	No diversion or Diversion type	Total feed (kgs Pu)	Hull (kgs Pu)	Waste (kgs Pu)	Total product (kgs Pu)	Total diversion (kgs Pu)	Diversion rate (Diversion / Feed)
S.S.1-1	No diversion	414.00	0.637	1.801	411.562	4.742	0.0115
	Uniform div.				406.820		
S.S.1-2	No diversion	532.00	0.818	1.981	529.201	6.133	0.0115
	Uniform div.				523.068		
S.S.1-3	No diversion	624.00	0.960	2.121	620.919	7.205	0.0115
	Uniform div.				613.714		
S.S.1-4	No diversion	492.00	0.757	1.919	489.324	5.637	0.0115
	Uniform div.				483.687		
S.S.1-5	No diversion	760.00	1.169	2.331	756.50	8.780	0.0116
	Uniform div.				747.720		
	Random div.				748.575		
	Single div.				748.605		
	Uniform div.				752.496		
	Random div.				752.540		
	Single div.				752.550		
Uniform div.	1520.00	2.337	4.663	1508.564	4.436	0.0029	
S.S.1-6	No diversion	894.00	1.375	2.536	890.089	10.332	0.0116
	Uniform div.				879.757		
S.S.1-7	No diversion	711.36	1.094	2.181	708.085	8.217	0.0116
	Uniform div.				699.868		
	Uniform div.	614.08	0.944	1.882	704.073	4.012	0.0056
S.S.1-8	No diversion	614.08	0.944	1.882	611.254	7.096	0.0116
	Uniform div.				604.158		
	Random div.				603.432		
	Single div.				602.368		
	Uniform div.				607.253		
	Random div.				607.348		
	Single div.				607.306		
S.S.1-9	No diversion	443.84	0.683	1.361	441.796	7.978	0.0180
	Uniform div.				433.818		
	Uniform div.	887.68	1.365	2.923	439.124	2.672	0.0060
S.S.1-9-2	No diversion	887.68	1.365	2.923	883.610	5.448	0.0061
	Uniform div.				878.150		
S.S.1-10	No diversion	395.20	0.608	1.212	393.380	7.274	0.0184
	Uniform div.				386.106		
	Uniform div.	790.40	1.216	2.603	390.705	2.675	0.0068
S.S.1-10-2	No diversion	790.40	1.216	2.603	786.760	4.930	0.0062
	Uniform div.				781.860		
S.S.4	No diversion	577.10	0.887	1.827	574.386	8.119	0.0141
	Uniform div.				566.267		
	Random div.				566.836		
	Single div.				565.532		
	Uniform div.				570.324		
	Random div.				570.615		
	Single div.				569.966		

Table 5.9(1) Pu concentration at the equilibrium state (S.S.1-1)

Process unit No.	Pu concentration of feed (g/L)	Pu concentration of product (g/L)	Pu concentration of waste (mg/L)	Pu holdup (Kg)	Process unit volume (L)	U holdup (Kg)
1	0.0	2.045	0.0	1.652	807.6	392.63
2	0.0	0.841	0.0	1.667	1982.6	396.22
3	0.0	0.757	0.0	1.651	2181.0	392.51
4	0.0	0.757	0.0	1.198	1582.7	284.88
5	0.757	0.376	0.152	0.328	1621.3	59.27
6	0.376	0.320	0.439	0.048	1334.4	15.77
7	0.320	0.237	0.0	0.019	80.0	4.52
8	0.237	0.236	0.0	0.469	1988.1	111.67
9	0.236	0.322	0.220	0.241	3246.4	47.00
10	0.273	0.867	0.076	0.163	1289.7	87.58
11	0.867	0.731	0.0	0.058	80.0	0.07
12	0.731	0.729	0.0	0.465	638.1	0.54
13	0.729	0.728	0.0	0.071	98.1	0.08
14	0.728	2.304	0.170	0.232	418.5	0.21
15	2.304	5.512	0.382	0.135	156.4	2.40
16	5.512	5.531	0.0	0.332	60.1	0.0
17	5.531	272.57	0.0	8.184	30.0	0.11
18	0.0	219.17	0.0	0.012	0.1	0.0
19	-	-	-	-	-	-
20	0.0	0.0	0.003	0.0	1612.8	13.83

Table 5.9(2) Pu concentration at the equilibrium state (S.S.1-2)

Process unit No.	Pu concentration of feed (g/L)	Pu concentration of product (g/L)	Pu concentration of waste (mg/l)	Pu holdup (Kg)	Process unit volume (L)	U holdup (Kg)
1	0.0	2.630	0.0	2.146	816.2	394.01
2	0.0	1.089	0.0	2.105	1932.9	386.49
3	0.0	0.980	0.0	2.153	2195.6	395.19
4	0.0	0.980	0.0	1.569	1599.8	287.95
5	0.980	0.482	0.196	0.423	1621.3	58.95
6	0.482	0.413	0.564	0.062	1334.4	15.66
7	0.413	0.305	0.0	0.024	80.0	4.49
8	0.305	0.307	0.0	0.818	2666.0	150.37
9	0.307	0.421	0.286	0.313	3246.6	47.24
10	0.356	1.118	0.099	0.211	1289.7	87.84
11	1.118	0.943	0.0	0.075	80.0	0.07
12	0.943	0.943	0.0	0.448	475.2	0.40
13	0.943	0.943	0.0	0.093	98.1	0.08
14	0.943	2.969	0.221	0.300	418.5	0.21
15	2.969	7.214	0.493	0.175	156.4	2.40
16	7.214	7.180	0.0	0.436	60.7	0.0
17	7.180	181.96	0.0	5.470	30.1	0.06
18	0.0	260.46	0.0	0.024	0.1	0.0
19	-	-	-	-	-	-
20	0.0	0.0	0.004	0.0	1612.8	13.70

Table 5.9(3) Pu concentration at the equilibrium state (S.S.1-3)

Process unit No.	Pu concentration of feed (g/L)	Pu concentration of product (g/L)	Pu concentration of waste (mg/L)	Pu holdup (Kg)	Process unit volume (L)	U holdup (Kg)
1	0.0	3.085	0.0	2.507	812.6	390.24
2	0.0	1.284	0.0	0.369	287.6	57.48
3	1.284	1.284	0.0	2.130	1658.7	331.48
4	0.0	1.156	0.0	2.856	2469.9	444.56
5	1.156	0.571	0.232	0.500	1621.3	59.08
6	0.571	0.490	0.667	0.074	1334.4	15.75
7	0.490	0.362	0.0	0.029	80.0	4.52
8	0.362	0.360	0.0	0.954	2647.7	148.66
9	0.360	0.492	0.336	0.368	3246.6	46.99
10	0.417	1.321	0.116	0.248	1289.7	87.49
11	1.321	1.113	0.0	0.089	80.0	0.07
12	1.113	1.107	0.0	0.614	554.5	0.47
13	1.107	1.106	0.0	0.108	98.1	0.08
14	1.106	3.443	0.258	0.351	418.5	0.21
15	3.443	8.357	0.571	0.203	156.4	2.39
16	8.357	8.349	0.0	0.525	62.9	0.0
17	8.349	136.40	0.0	4.102	30.1	0.04
18	0.0	280.77	0.0	0.024	0.1	0.0
19	-	-	-	-	-	-
20	0.0	0.0	0.005	0.0	1612.8	13.84

Table 5.9 (4) Pu concentration at the equilibrium state (S.S.1-4)

Process unit No.	Pu concentration of feed (g/L)	Pu concentration of product (g/L)	Pu concentration of waste (mg/L)	Pu holdup (Kg)	Process unit volume (L)	U holdup (Kg)
1	0.0	2.431	0.0	1.971	810.8	394.20
2	0.0	1.000	0.0	1.981	1980.6	396.08
3	0.0	0.900	0.0	1.917	2129.9	383.31
4	0.900	0.900	0.0	1.334	1481.6	266.65
5	0.900	0.445	0.181	0.389	1621.3	59.14
6	0.445	0.377	0.520	0.057	1334.4	15.66
7	0.377	0.279	0.0	0.022	80.0	4.47
8	0.279	0.279	0.0	0.773	2767.3	154.83
9	0.279	0.380	0.260	0.285	3246.6	46.81
10	0.322	1.026	0.090	0.192	1289.7	87.14
11	1.026	0.862	0.0	0.069	80.0	0.07
12	0.862	0.863	0.0	0.554	642.3	0.54
13	0.863	0.863	0.0	0.085	98.1	0.08
14	0.863	2.684	0.201	0.274	418.5	0.21
15	2.684	6.507	0.445	0.158	156.4	2.39
16	6.507	6.558	0.0	0.580	88.4	0.01
17	6.558	20.183	0.0	0.606	30.0	0.01
18	0.0	307.95	0.0	0.029	0.1	0.0
19	-	-	-	-	-	-
20	0.0	0.0	0.004	0.0	1612.8	13.71

Table 5.9(5) Pu concentration at the equilibrium state (S.S.1-5)

Process unit No.	Pu concentration of feed (g/L)	Pu concentration of product (g/L)	Pu concentration of waste (mg/L)	Pu holdup (Kg)	Process unit volume (L)	U holdup (Kg)
1	0.0	3.759	0.0	3.049	811.0	388.28
2	0.0	1.570	0.0	3.048	1941.4	388.18
3	0.0	1.413	0.0	3.035	2147.7	386.53
4	0.0	1.413	0.0	2.304	1630.3	293.40
5	1.413	0.694	0.283	0.608	1621.3	58.86
6	0.694	0.587	0.811	0.089	1334.4	15.54
7	0.587	0.435	0.0	0.035	80.0	4.44
8	0.435	0.438	0.0	1.234	2819.7	157.37
9	0.438	0.594	0.408	0.445	3246.6	46.54
10	0.502	1.590	0.140	0.299	1289.7	86.37
11	1.590	1.345	0.0	0.108	80.0	0.07
12	1.345	1.350	0.0	0.796	590.0	0.49
13	1.350	1.350	0.0	0.132	98.1	0.08
14	1.350	4.209	0.315	0.428	418.5	0.21
15	4.209	10.214	0.698	0.248	156.4	2.39
16	10.214	10.242	0.0	0.612	59.7	0.0
17	10.242	273.68	0.0	8.226	30.1	0.06
18	0.0	293.13	0.0	0.010	0.0	0.0
19	-	-	-	-	-	-
20	0.0	0.0	0.007	0.0	1612.8	13.56

Table 5.9 (6) Pu concentration at the equilibrium state (S.S.1-6)

Process unit No.	Pu concentration of feed (g/L)	Pu concentration of product (g/L)	Pu concentration of waste (mg/L)	Pu holdup (Kg)	Process unit volume (L)	U holdup (Kg)
1	0.0	4.423	0.0	3.613	816.9	387.86
2	0.0	1.862	0.0	3.542	1902.2	380.25
3	0.0	1.677	0.0	3.598	2145.8	386.21
4	0.0	1.676	0.0	2.481	1480.2	266.38
5	1.676	0.820	0.335	0.720	1621.3	58.72
6	0.820	0.705	0.959	0.106	1334.4	15.61
7	0.705	0.521	0.0	0.042	80.0	4.48
8	0.521	0.520	0.0	1.330	2556.2	142.90
9	0.520	0.700	0.485	0.528	3246.6	46.52
10	0.594	1.898	0.166	0.355	1289.7	86.29
11	1.898	1.604	0.0	0.128	80.0	0.07
12	1.604	1.606	0.0	0.950	591.4	0.50
13	1.606	1.606	0.0	0.158	98.1	0.08
14	1.606	5.061	0.375	0.511	418.5	0.21
15	5.061	12.229	0.839	0.298	156.4	2.41
16	12.229	12.286	0.0	1.083	88.1	0.01
17	12.286	47.066	0.0	1.416	30.1	0.01
18	0.0	214.37	0.0	0.006	0.0	0.0
19	-	-	-	-	-	-
20	0.0	0.0	0.007	0.0	1612.8	13.68

Table 5.11 Comparison between MUF of S.S.1-8 and One of S.S.4

[unit : kg.Pu]

Material Balance No.	MUFd		σ MUFd		CUMUF		σ CUMUF	
	S.S.1-8	S.S.4	S.S.1-8	S.S.4	S.S.1-8	S.S.4	S.S.1-8	S.S.4
1	2.704	1.726	0.443	0.244	2.704	1.726	0.443	0.244
2	0.089	1.090	0.483	0.339	2.793	2.816	0.929	0.543
3	0.415	0.648	0.388	0.462	3.207	3.464	1.287	0.925
4	0.527	-0.698	0.447	0.488	3.734	2.765	1.604	1.332
5	0.277	-0.363	0.198	0.188	4.012	2.403	1.721	1.439
6	0.317	0.306	0.470	0.425	4.328	2.708	2.056	1.760
7	0.198	0.557	0.428	0.493	4.527	3.265	2.372	2.134
8	0.264	-1.362	0.461	0.504	4.790	1.904	2.738	2.498
9	0.389	1.442	0.491	0.289	5.179	3.346	3.068	2.688
10	-0.737	0.097	0.512	0.554	4.441	3.443	3.468	3.077
11	-0.815	-1.462	0.462	0.387	3.626	1.982	3.783	3.353
12	-0.465	1.416	0.457	0.382	3.161	3.397	4.105	3.636
13	-0.127	-1.289	0.394	0.372	3.034	2.108	4.420	3.900
14	0.141	1.193	0.445	0.333	3.175	3.301	4.736	4.161
15	0.148	-0.184	0.480	0.516	3.323	3.117	5.108	4.574
16	0.369	-0.490	0.477	0.449	3.692	2.627	5.442	4.923
17	-2.036	-2.466	0.097	0.175	1.656	0.161	5.462	4.951
Average	0.097	0.009	0.433	0.404				

Table 5.12(1) Comparison of MUF_d and σ_{MUF_d} for Four Measurement Error Types with No Diversion Case S.S.1-5-1

[unit : kg.Pu]

Error Type DMBP	1		2		3		4	
	MUF_d	σ_{MUF_d}	MUF_d	σ_{MUF_d}	MUF_d	σ_{MUF_d}	MUF_d	σ_{MUF_d}
1	2.726	0.414	2.745	0.406	2.476	0.148	2.478	0.146
2	0.326	0.444	0.347	0.435	0.068	0.163	-0.053	0.159
3	0.260	0.388	0.241	0.380	0.100	0.143	0.088	0.139
4	-0.505	0.414	-0.451	0.399	0.017	0.153	0.030	0.148
5	0.049	0.483	-0.078	0.470	0.098	0.178	0.054	0.172
6	-0.031	0.463	0.100	0.450	-0.140	0.167	-0.089	0.161
7	0.243	0.458	0.168	0.445	0.031	0.159	-0.001	0.152
8	0.432	0.512	0.432	0.501	0.113	0.174	0.112	0.168
9	0.353	0.434	0.378	0.417	0.026	0.156	0.043	0.147
10	0.036	0.443	0.036	0.423	0.049	0.161	0.032	0.152
11	0.069	0.466	0.030	0.451	-0.023	0.168	-0.021	0.162
12	0.231	0.434	0.298	0.424	0.380	0.161	0.067	0.157
13	0.335	0.421	0.306	0.408	0.113	0.157	0.098	0.150
14	0.195	0.428	0.135	0.407	0.070	0.160	0.046	0.150
15	-0.030	0.475	-0.050	0.451	0.067	0.177	0.049	0.165
16	-0.238	0.467	-0.096	0.443	-0.142	0.165	-0.084	0.153
17	0.149	0.427	0.110	0.408	0.172	0.151	0.158	0.142
18	-0.320	0.428	-0.306	0.414	-0.111	0.149	-0.102	0.142
19	-1.644	0.382	-1.710	0.369	-1.979	0.123	-2.001	0.119
20	-0.370	0.079	-3.669	0.078	-0.379	0.020	-0.377	0.020
Average	0.113	0.431	0.113	0.417	0.026	0.155	0.026	0.149

Table 5.12(2) Comparison of CUMUF and σ_{CUMUF} for Four Measurement Error Types with No Diversion Case S.S.1-5-1

[unit : kg.Pu]

Error Type DMBP	1		2		3		4	
	CUMUF	σ_{CUMUF}	CUMUF	σ_{CUMUF}	CUMUF	σ_{CUMUF}	CUMUF	σ_{CUMUF}
1	2.726	0.414	2.745	0.406	2.476	0.148	2.478	0.146
2	3.052	0.796	3.092	0.789	2.408	0.301	2.426	0.299
3	3.312	1.113	3.333	1.108	2.508	0.433	2.513	0.431
4	2.807	1.448	2.883	1.439	2.524	0.574	2.543	0.572
5	2.856	1.831	2.804	1.824	2.622	0.740	2.597	0.737
6	2.826	2.192	2.904	2.184	2.482	0.895	2.509	0.893
7	3.069	2.526	3.072	2.519	2.513	1.040	2.508	1.037
8	3.051	2.899	3.504	2.891	2.626	1.202	2.620	1.199
9	3.854	3.221	3.882	3.213	2.652	1.342	2.662	1.338
10	3.890	3.549	3.918	3.540	2.701	1.484	2.695	1.481
11	3.959	3.907	3.948	3.899	2.678	1.640	2.674	1.637
12	4.190	4.257	4.246	4.249	2.716	1.792	2.741	1.789
13	4.525	4.587	4.552	4.579	2.829	1.934	2.839	1.931
14	4.721	4.910	4.687	4.901	2.900	2.075	2.884	2.071
15	4.691	5.265	4.637	5.256	2.967	2.228	2.933	2.225
16	4.453	5.596	4.541	5.586	2.825	2.372	2.849	2.368
17	4.601	5.901	4.650	5.891	2.997	2.505	3.008	2.501
18	4.282	3.858	4.344	6.201	2.886	2.639	2.906	2.635
19	2.638	6.477	2.634	6.468	9.071	2.753	0.905	2.750
20	2.267	6.480	2.267	6.471	0.528	2.754	0.528	2.751

Table 5.13(1) MUF_d and σ_{MUFd} for Different Recalibration Frequencies with
No Diversion Case of S.S.1-5-1

[unit: kg Pu]

Material Balance No.	MUF _d and σ_{MUFd}						CUMUF and σ_{CUMUFd}					
	Weekly Recalibration		Tri-weekly Recalibration		Monthly Recalibration		Weekly Recalibration		Tri-weekly Recalibration		Monthly Recalibration	
	MUFd	σ_{MUFd}	MUFd	σ_{MUFd}	MUFd	σ_{MUFd}	CUMUF	σ_{CUMUF}	CUMUF	σ_{CUMUF}	CUMUF	σ_{CUMUF}
1	2.726	0.414	2.704	0.443	2.704	0.443	2.726	0.414	2.704	0.443	2.704	0.443
2	0.326	0.444	0.089	0.483	0.089	0.483	3.052	0.796	2.793	0.929	2.793	0.929
3	0.260	0.388	0.415	0.388	0.393	0.424	3.312	1.113	3.207	1.287	3.186	1.351
4	-0.505	0.414	0.427	0.450	0.256	0.429	2.807	1.448	3.634	1.604	3.441	1.765
5	0.049	0.483	0.628	0.533	0.628	0.533	2.856	1.831	4.262	2.041	4.069	2.106
6	-0.031	0.463	0.133	0.462	0.047	0.486	2.826	2.192	4.394	2.398	4.116	2.488
7	0.243	0.458	0.512	0.467	0.411	0.471	3.069	2.526	4.906	2.733	4.527	2.877
8	0.432	0.512	0.560	0.492	0.769	0.467	3.501	2.899	5.467	3.133	5.296	3.270
9	0.353	0.434	-0.439	0.455	0.465	0.449	3.854	3.221	5.028	3.440	5.761	3.571
10	0.036	0.443	-0.484	0.471	0.457	0.465	3.890	3.549	4.544	3.782	6.218	3.905
11	0.069	0.466	-0.593	0.469	0.568	0.502	3.959	3.907	3.951	4.160	6.787	4.297
12	0.231	0.434	-0.639	0.475	-0.073	0.443	4.190	4.257	3.313	4.500	6.714	4.644
13	0.335	0.421	-0.408	0.461	-0.182	0.462	4.625	4.587	2.905	4.841	6.532	4.960
14	0.195	0.428	0.136	0.427	-0.280	0.461	4.721	4.910	3.041	5.163	6.251	5.293
15	-0.030	0.475	0.489	0.511	-0.433	0.516	4.691	5.265	3.530	5.511	5.819	5.676
16	-0.238	0.467	0.703	0.472	-0.963	0.447	4.453	5.596	3.600	5.854	4.855	6.009
17	0.149	0.427	0.657	0.426	-0.288	0.442	4.601	5.901	4.257	6.153	4.568	6.303
18	-0.320	0.428	0.127	0.435	-0.823	0.438	4.282	6.211	4.384	6.459	3.745	6.616
19	-1.644	0.382	-1.574	0.386	-2.447	0.389	2.638	6.477	2.811	6.735	1.299	6.899
20	-0.370	0.079	-0.370	0.079	-0.388	0.081	2.267	6.480	2.441	6.739	0.911	6.903
Average	0.113	0.431	0.122	0.448	0.046	0.450						

Table 5.13(2) MUF_d and σ_{MUFd} for Different Recalibration Frequencies with No Diversion Case of S.S.1-8

[unit: kg Pu]

Material Balance No.	MUF_d and σ_{MUFd}						CUMUF and σ_{CUMUFd}					
	Weekly Recalibration		Tri-weekly Recalibration		Monthly Recalibration		Weekly Recalibration		Tri-weekly Recalibration		Monthly Recalibration	
	MUF_d	σ_{MUFd}	MUF_d	σ_{MUFd}	MUF_d	σ_{MUFd}	CUMUF	σ_{CUMUF}	CUMUF	σ_{CUMUF}	CUMUF	σ_{CUMUF}
1	2.726	0.414	2.704	0.443	2.704	0.443	2.726	0.414	2.704	0.443	2.704	0.443
2	0.326	0.444	0.089	0.484	0.089	0.483	3.052	0.796	2.793	0.929	2.793	0.929
3	0.260	0.388	0.415	0.388	0.393	0.424	3.312	1.113	3.207	1.287	3.186	1.351
4	-0.404	0.411	0.527	0.447	0.356	0.425	2.908	1.447	3.734	1.604	3.542	1.764
5	0.139	0.199	0.277	0.198	0.277	0.198	3.047	1.550	4.012	1.721	3.819	1.850
6	0.116	0.471	0.317	0.470	0.222	0.490	3.163	1.899	4.328	2.056	4.041	2.182
7	-0.059	0.454	0.198	0.428	0.095	0.431	3.104	2.205	4.527	2.372	4.136	2.513
8	-0.099	0.481	0.264	0.461	0.236	0.429	3.005	2.534	4.790	2.738	4.372	2.854
9	1.021	0.455	0.389	0.491	1.259	0.490	4.027	2.868	5.179	3.068	5.631	3.168
10	-0.063	0.530	-0.737	0.512	0.407	0.536	3.964	3.263	4.441	3.468	6.038	3.578
11	0.100	0.438	-0.815	0.462	-0.062	0.426	4.064	3.592	3.626	3.783	5.976	3.909
12	0.242	0.425	-0.465	0.457	-0.271	0.458	4.306	3.900	3.161	4.105	5.705	4.204
13	0.051	0.385	-0.127	0.394	-0.373	0.437	4.358	4.206	3.033	4.420	5.331	4.521
14	-0.210	0.422	0.141	0.445	-0.715	0.431	4.147	4.532	3.175	4.736	4.617	4.862
15	-0.357	0.481	0.148	0.480	-1.027	0.529	3.791	4.907	3.323	5.108	3.590	5.221
16	-0.178	0.450	0.369	0.477	-0.687	0.480	3.613	5.244	3.692	5.442	2.902	5.566
17	-2.115	0.098	-2.036	0.097	-2.143	0.098	1.498	5.264	1.656	5.462	0.760	5.588
Average	0.088	0.421	0.097	0.433	0.045	0.438						

Table 5.13(3) MUF_d and σ_{MUFd} for Different Recalibration Frequencies with No Diversion Case of S.S.4

[unit: kg Pu]

Material Balance No.	MUF_d and σ_{MUFd}						CUMUF and σ_{CUMUFd}					
	Weekly Recalibration		Tri-weekly Recalibration		Monthly Recalibration		Weekly Recalibration		Tri-weekly Recalibration		Monthly Recalibration	
	MUF_d	σ_{MUFd}	MUF_d	σ_{MUFd}	MUF_d	σ_{MUFd}	CUMUF	σ_{CUMUF}	CUMUF	σ_{CUMUF}	CUMUF	σ_{CUMUF}
1	1.726	0.244	1.757	0.253	1.757	0.253	1.726	0.244	1.757	0.253	1.757	0.253
2	1.090	0.339	0.945	0.355	0.945	0.355	2.816	0.543	2.702	0.605	2.702	0.605
3	0.648	0.462	0.741	0.463	0.727	0.502	3.464	0.925	3.444	1.049	3.429	1.104
4	-0.698	0.488	0.395	0.531	0.206	0.506	2.765	1.332	3.838	1.446	3.635	1.604
5	-0.363	0.188	-0.217	0.187	-0.217	0.187	2.403	1.439	3.621	1.576	3.418	1.694
6	0.306	0.425	0.435	0.425	0.390	0.456	2.708	1.760	4.055	1.904	3.807	2.006
7	0.557	0.493	0.840	0.517	0.748	0.521	3.625	2.134	4.895	2.284	4.555	2.414
8	-1.362	0.504	-0.919	0.507	-1.012	0.466	1.904	2.498	3.976	2.696	3.543	2.803
9	1.442	0.289	1.029	0.317	1.546	0.288	3.346	2.688	5.005	2.877	5.088	2.982
10	0.097	0.554	-0.497	0.530	0.623	0.522	3.443	3.077	4.507	3.269	5.711	3.369
11	-1.462	0.387	-2.136	0.417	-1.325	0.356	1.982	3.353	2.371	3.535	4.386	3.659
12	1.416	0.382	0.750	0.398	0.965	0.399	3.397	3.636	3.121	3.820	5.351	3.922
13	-1.289	0.372	-1.577	0.373	-1.650	0.399	2.108	3.900	1.544	4.096	3.702	4.190
14	1.193	0.333	1.474	0.355	0.794	0.339	3.301	4.161	3.018	4.347	4.496	4.458
15	-0.184	0.516	0.351	0.515	-0.943	0.573	3.117	4.574	3.369	4.754	3.554	4.857
16	-0.490	0.449	0.049	0.484	-1.006	0.488	2.627	4.923	3.419	5.100	2.548	5.217
17	-2.466	0.175	-2.362	0.175	-2.518	0.176	0.161	4.951	1.056	5.129	0.030	5.249
Average	0.009	0.404	0.062	0.416	0.002	0.416						

Table 5.14(1) Components of Variance (and Relative Standard Deviation) of CUMUF at 10th near-real-time Material Balance Period with no Diversion Case of S.S.1-5-1

[Unit : kg²]

Operation	Type of Error Components	Material Balance Components (CUMUF = 3.890 kg)					
		Input	Product	Waste	Beginning Inventory	Ending Inventory	Total
Bulk Measurement	Random	0.0200	0.0221	0.0	0.0	0.0083	0.0504
	(%)	0.18	0.20			0.08	0.46
	Short	1.5098	0.4040	0.0005	0.0	0.0046	1.9189
	(%)	13.92	3.72	0.00		0.04	17.69
	Long	1.5098	0.4256	0.0005	0.0	0.0046	1.9405
(%)	13.92	3.92	0.00		0.04	17.89	
Total	3.0396	0.8517	0.0010	0.0	0.0175	3.9098	
(%)	28.02	7.85	0.01		0.16	36.04	
Sampling	Random	0.0100	0.0307	0.0	0.0	0.0067	0.0474
	(%)	0.09	0.28			0.06	0.44
	Short	1.5098	0.9090	0.0019	0.0	0.0050	2.4257
	(%)	13.92	8.38	0.02		0.05	22.36
Total	1.5198	0.9397	0.0019	0.0	0.0117	2.4731	
(%)	14.01	8.66	0.02		0.11	22.80	
Analysis	Random	0.0506	0.0602	0.0	0.0	0.0026	0.1134
	(%)	0.47	0.55			0.02	1.05
	Short	0.2409	0.4571	0.0001	0.0	0.0038	0.7019
	(%)	2.22	4.21	0.00		0.04	6.47
	Long	2.6841	0.9584	0.0053	0.0	0.0010	3.6488
(%)	24.75	8.84	0.05		0.01	33.64	
Total	2.9756	1.4757	0.0054	0.0	0.0074	4.4641	
(%)	27.43	13.60	0.05		0.07	41.16	
Total	7.5350	3.2671	0.0083	0.0	0.0366	10.8470	
(%)	69.47	30.12	0.08		0.34	100.00	
Measurement Value (kg)		409.584	389.138	1.335	0.0	15.221	

Table 5.14(2)

Components of Variance (and Relative Standard Deviation) of CUMUF at 20th near-real-time Material Balance Period with no Diversion Case of S.S.1-5-1

[Unit : kg²]

Operation	Type of Error Components	Material Balance Components (CUMUF = 2.267 kg)					
		Input	Product	Waste	Beginning Inventory	Ending Inventory	Total
Bulk Measurement	Random	0.0370	0.0417	0.0	0.0	0.0	0.0787
	(%)	0.10	0.12				0.22
	Short	5.1846	1.4560	0.0016	0.0	0.0	6.6422
	(%)	14.43	4.05	0.00			18.48
	Long	5.1846	1.4560	0.0016	0.0	0.0	6.6422
	(%)	14.43	4.05	0.00			18.48
	Total	10.4062	2.9537	0.0032	0.0	0.0	13.3631
	(%)	28.96	8.22	0.01			37.19
Sampling	Random	0.0185	0.0579	0.0	0.0	0.0	0.0764
	(%)	0.05	0.16				0.21
	Short	5.1846	3.2758	0.0065	0.0	0.0	8.4669
	(%)	14.43	9.12	0.02			23.56
	Total	5.2031	3.3337	0.0065	0.0	0.0	8.5433
	(%)	14.48	9.28	0.02			23.78
Analysis	Random	0.0937	0.1135	0.0001	0.0	0.0	0.2073
	(%)	0.26	0.32	0.00			0.58
	Short	0.4456	0.8629	0.0002	0.0	0.0	1.3087
	(%)	1.24	2.40	0.00			3.64
	Long	9.2171	3.2760	0.0182	0.0	0.0	12.5113
(%)	25.65	9.12	0.05			34.82	
	Total	9.7564	4.2524	0.0185	0.0	0.0	14.0273
	(%)	27.15	11.83	0.05			39.04
Total		25.3657	10.5398	0.0282	0.0	0.0	35.9337
(%)		70.59	29.33	0.08			100.00
Measurement Value (kg)		758.992	754.228	2.486	0.0	0.020	

Table 5.15 True-Diversion and Estimation of Diversion for Uniform Diversion Cases

[Unit : kg.pu]

Simulation Study	In a Static Material Balance Period			In a N.R.T. Material Balance Period				
	Actual Diverted Amounts	Estimates of CUMUF		Actual Diverted Amounts	Estimates of Kalman filter			
		CUMUF	σ_{MUF}		One-State Kalman F.		Two-State Kalman F.	
					MUFd	σ_{MUFd}	MUFd	σ_{MUFd}
S.S.1-1	4.742	5.778	3.517	0.250	0.236	0.064	0.238	0.056
1-2	6.133	8.171	4.517	0.323	0.212	0.082	0.287	0.074
1-3	7.205	9.358	5.299	0.360	0.288	0.088	0.270	0.080
1-4	5.637	7.002	4.173	0.313	0.421	0.078	0.420	0.071
1-5-1	8.780	10.197	6.452	0.462	0.546	0.110	0.538	0.102
1-5-1	4.004	6.705	6.459	0.200	0.255	0.104	0.257	0.097
1-5-2	4.436	11.047	12.513	0.115	0.239	0.078	0.238	0.071
1-6	10.332	11.963	7.599	0.517	0.570	0.123	0.570	0.115
1-7	8.217	8.858	6.049	0.457	0.504	0.114	0.489	0.106
1-7	4.012	5.779	6.064	0.211	0.280	0.106	0.293	0.098
1-8	7.096	9.117	5.236	0.444	0.592	0.117	0.592	0.112
1-8	4.001	5.734	5.247	0.235	0.761	0.096	0.638	0.092
1-9	7.978	8.722	3.821	0.665	0.796	0.143	0.786	0.133
1-9	2.672	3.523	3.843	0.223	0.252	0.141	0.250	0.129
1-10	7.274	8.068	3.422	0.661	0.356	0.101	0.428	0.105
1-10	2.675	4.086	3.432	0.243	0.287	0.119	0.298	0.116
4	8.119	9.053	4.928	0.478	0.426	0.088	0.459	0.086
4	4.062	5.392	4.945	0.239	0.494	0.094	0.425	0.091

Table 5.16 Material Balance for Uniform Diversion Case

Diversion Mode	Simulation Study	Total Feed (kg)	Average Diversion Rate in NRTMBP (kg)	Total Diversion in a TMBP (kg)	N.R.T. Material Accounting			Traditional Material Accounting			
					\overline{MUF}_d (kg/NRTMBP)	$\overline{\sigma MUF}_d$ (kg/NRTMBP)	LEMUF = $2\overline{\sigma MUF}_d$ (kg/NRTMBP)	MUF (kg/TMBP)	σMUF (kg/TMBP)	LEMUF = $2\sigma MUF$ (kg/TMBP)	
No Diversion	S.S.1-1	414	-	-	0.023	0.260	0.520	0.432	3.540	7.080	
	1-2	532	-	-	0.064	0.340	0.680	1.154	4.539	9.078	
	1-3	624	-	-	0.061	0.376	0.752	1.158	5.320	10.640	
	1-4	492	-	-	0.045	0.303	0.606	0.855	4.196	8.392	
	1-5	760	-	-	0.113	0.431	0.862	2.267	6.480	12.960	
	1-6	894	-	-	0.108	0.517	1.034	2.167	7.617	15.234	
	1-7	711	-	-	0.110	0.433	0.866	2.081	6.076	12.152	
	1-8	614	-	-	0.088	0.421	0.842	1.498	5.264	10.528	
	1-9	444	-	-	0.136	0.426	0.852	1.629	3.852	7.704	
	1-10	395	-	-	0.097	0.404	0.808	1.164	3.445	6.890	
	S.S.4	577	-	-	0.009	0.404	0.808	1.615	4.951	9.902	
	1-9-2	888	-	-	0.110	0.430	0.860	1.629	3.852	7.704	PIT-1
	1-10-2	790	-	-	0.074	0.420	0.840	1.006	3.866	7.732	PIT-2
							1.164	3.445	6.890	PIT-1	
							0.532	3.460	6.920	PIT-2	
Uniform Diversion of 0.25 ~ 1.5 \overline{MUF}_d per NRTMBP	S.S.1-1	414	0.250	4.742	0.304	0.259	0.518	5.778	3.516	7.032	
	1-2	532	0.323	6.133	0.430	0.327	0.654	8.171	4.517	8.314	
	1-3	624	0.360	7.205	0.468	0.368	0.736	9.358	5.299	10.598	
	1-4	492	0.313	5.637	0.389	0.312	0.624	7.002	4.173	8.346	
	1-5-1	760	0.462	8.780	0.537	0.451	0.902	10.197	6.452	12.904	
	1-5-2	1520	0.115	4.436	0.307	0.465	0.930	11.047	12.513	25.026	
	1-6	894	0.517	10.332	0.598	0.515	1.030	11.963	7.599	15.198	
	1-7	711	0.457	8.217	0.492	0.453	0.906	8.858	6.049	12.098	
	1-8	614	0.444	7.096	0.570	0.430	0.860	9.117	5.236	10.472	
	1-9	444	0.665	7.978	0.727	0.432	0.864	8.722	3.821	7.642	
	1-10	395	0.661	7.274	0.733	0.421	0.842	8.068	3.422	6.844	
	S.S.4	577	0.478	8.119	0.533	0.396	0.792	9.053	4.928	9.856	
	Uniform Diversion of 8 kgs per year	S.S.1-5-1	760	0.200	4.004	0.335	0.430	0.860	6.705	6.459	12.918
1-7		711	0.211	4.012	0.304	0.431	0.862	5.779	6.064	12.128	
1-8		614	0.235	4.001	0.337	0.423	0.846	5.734	5.247	10.494	
1-9		444	0.223	2.672	0.294	0.435	0.870	3.523	3.843	7.686	
1-10		395	0.243	2.675	0.371	0.424	0.848	4.086	3.432	6.864	
S.S.4		577	0.239	4.062	0.372	0.417	0.834	5.392	4.945	9.890	
1-9-2		888	0.227	5.448	0.417	0.435	0.870	5.805	3.841	7.682	PIT-1
								4.202	3.856	7.712	PIT-2
1-10-2		790	0.205	4.930	0.265	0.405	0.810	4.048	3.437	6.874	PIT-1
							2.305	3.450	6.900	PIT-2	

NRTMBP : N.R.T. Material Balance Period = 7 days

TMBP : Traditional Material Balance Period = $\begin{cases} 6 \text{ months for S.S.1-1} \sim \text{S.S.1-8 and S.S.4} \\ 4 \text{ months for S.S.1-9, S.S.1-10} \\ 10 \text{ months for S.S.1-5-2} \\ 4 \text{ months} \times 2 \text{ for S.S.1-9-2 and S.S.1-10-2} \end{cases}$

\overline{MUF}_d : Average \overline{MUF}_d
 $\overline{\sigma MUF}_d$: Average $\overline{\sigma MUF}_d$

Table 5.17 Alarm Generation Chart for Uniform Diversion Case

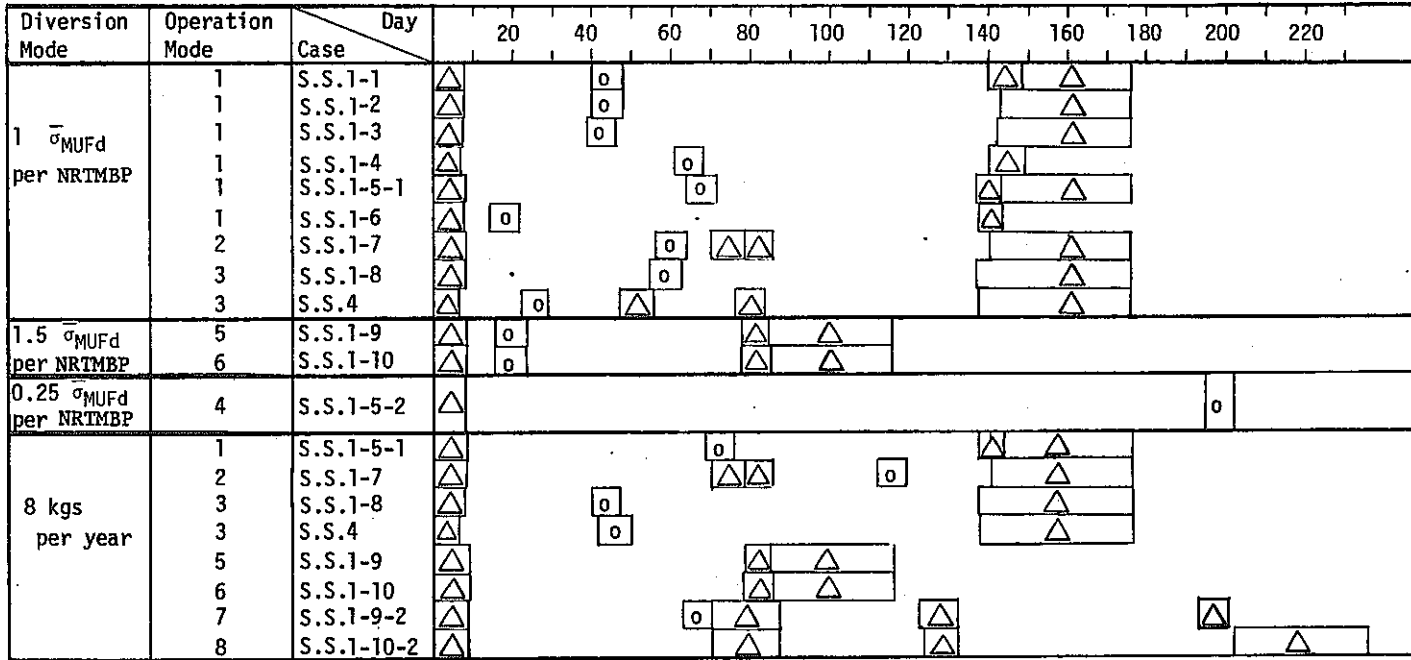

Operation Mode	Case	Day																							
		20	40	60	80	100	120	140	160	180	200	220	240												
1	S.S.1-1-6	Processing Run												Clean-out											
2	S.S.1-7	Processing Run						F	Processing Run						Clean-out										
3	S.S.1-8,4	P	F	P	F	P	F	P	F	P	F	P	F	P	F	P	F	P	F	P	F	P	F		
4	S.S.1-5-2	Processing Run																							
5	S.S.1-9	Processing Run												Clean-out											
6	S.S.1-10	P	F	P	F	P	F	P	F	P	F	P	F	P	F	P	F	P	F	P	F	P	F		
7	S.S.1-9-2	Processing Run												Clean-out											
8	S.S.1-10-2	P	F	P	F	P	F	P	F	P	F	P	F	P	F	P	F	P	F	P	F	P	F		

F : Flush-out

A symbol "o" shows an initial alarm, and
 A symbol "△" shows a false alarm generated in the simulation run
 of no diversion.

Table 5.18(1) Alarm Generation Chart for Three N.R.T. Material Balance Periods; Diversion amounts are $1 \sigma_{MUFd}$ per NRTMBP

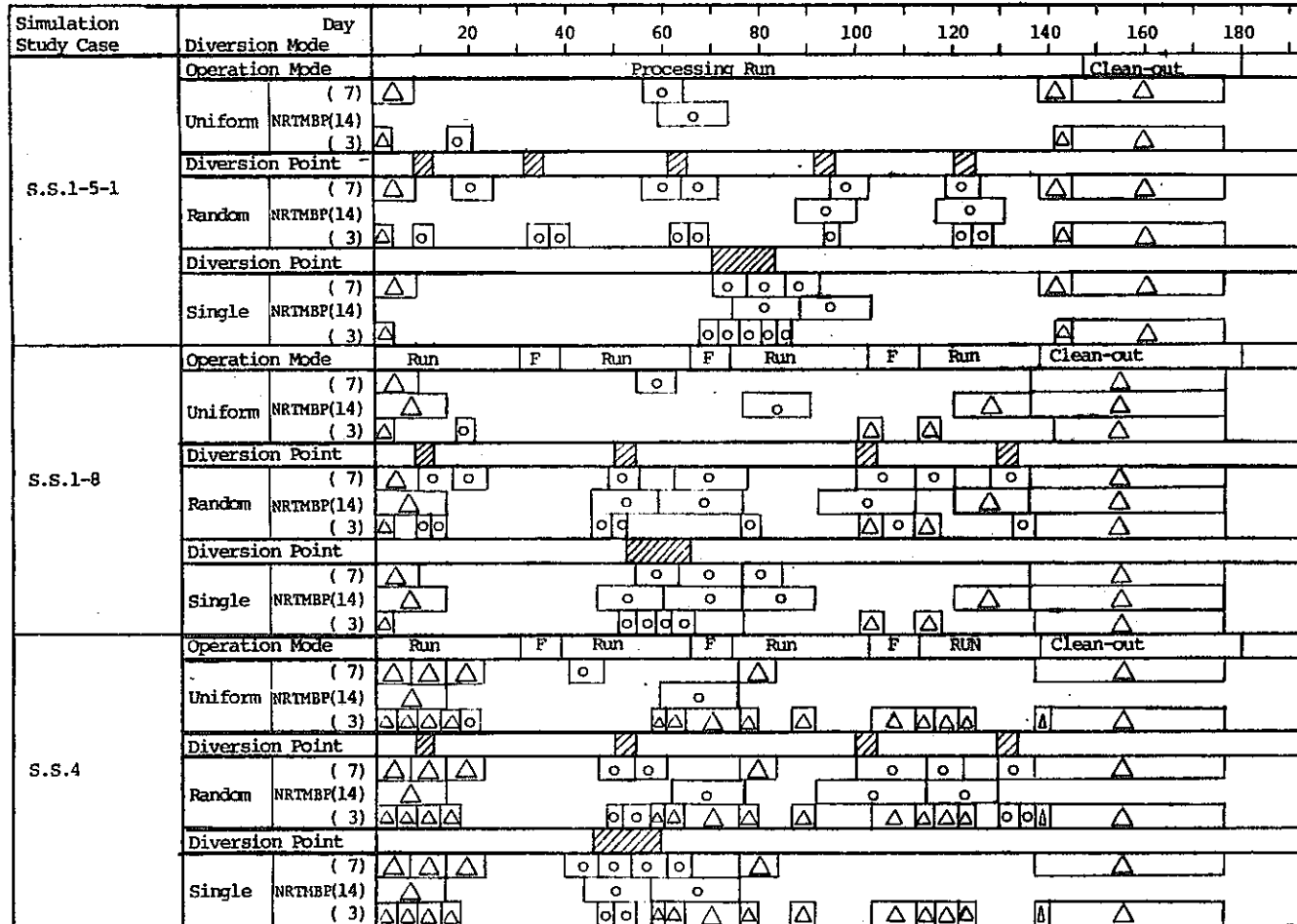

F : Flush-out

A symbol "O" shows an alarm for Random and Single diversion, and for Uniform diversion shows initial alarm, and A symbol "△" shows a false alarm generated in the simulation run of no diversion.

Table 5.18(2) Alarm Generation Chart for Three N.R.T. Material Balance Periods;
 Diversion amounts are 8 kgs per year

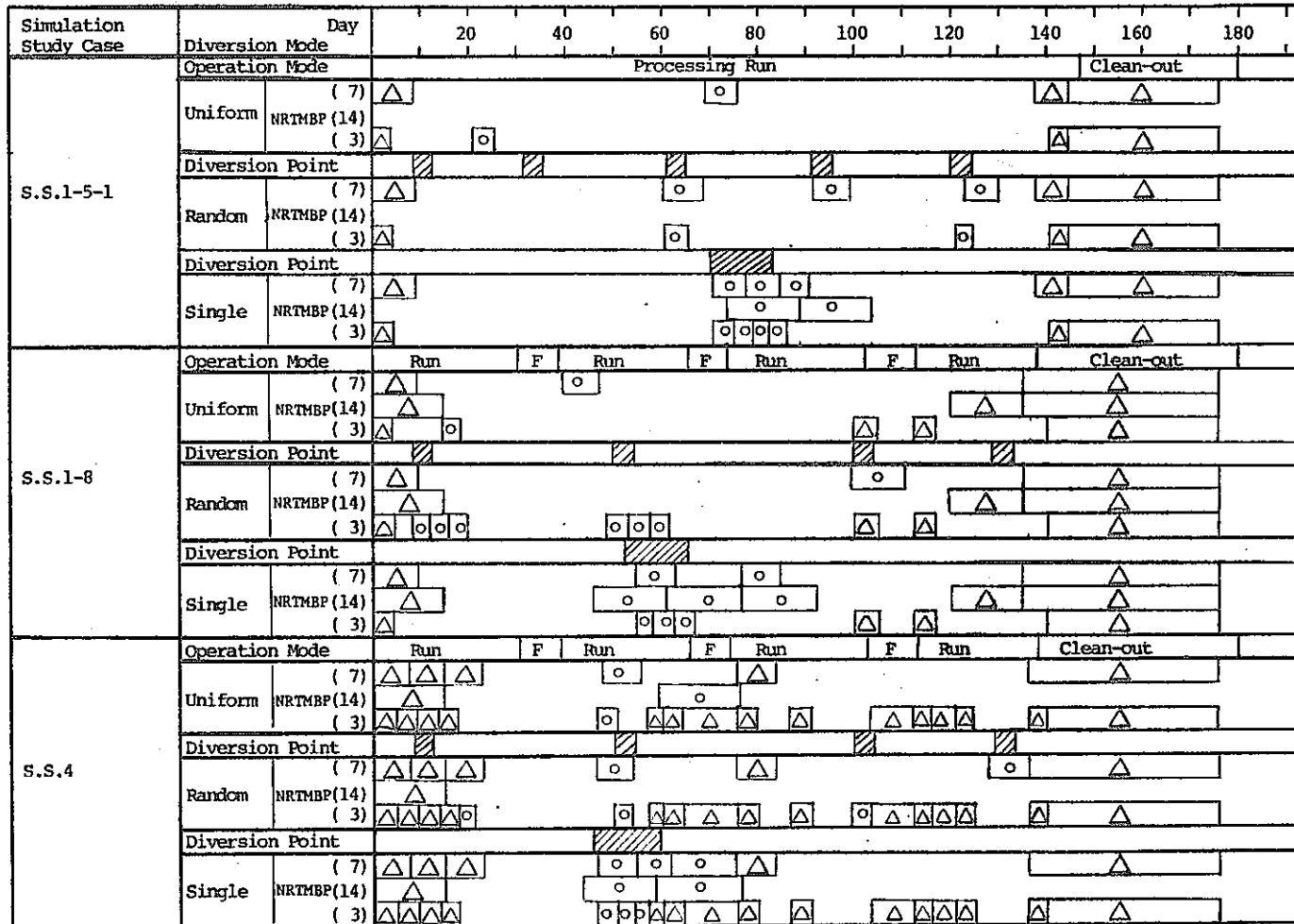

F : Flush-out

A symbol "o" shows an alarm for Random and Single diversion, and for Uniform diversion shows an initial alarm, and A symbol "△" shows a false alarm generated in the simulation run of no diversion

Table 5.19 Alarm Generation Chart for Partial and Full PITs with Uniform Diversion Cases; Diversion amounts are 8 kgs per year

Simulation Study Case	operation mode / PIT Models	20	40	60	80	100	120	140	160	180	200	220	240
S.S.1-7	Operation mode	Run			F	Run		Clean-out					
	Patial PIT	△			△△		○		△				
	Full PIT (E1)					○							
	Full PIT (E2)					○							
	Full PIT (E3)						○	△					
S.S.1-8	Operation mode	Run	F	Run	F	Run	F	Run	Clean-out				
	Partial PIT	△		○					△				
	Full PIT (E1)					○		△					
	Full PIT (E2)					○							
	Full PIT (E3)					○							
S.S.1-10	Operation mode	Run		F	Run	Clean-out							
	Partial PIT	△			△	△							
	Full PIT (E1)					△							
	Full PIT (E2)					△							
	Full PIT (E3)					△							
S.S.4	Operation mode	Run		F	Run	F	Run	F	Run	Clean-out			
	Partial PIT	△	○		△		△			△			
	Full PIT (E1)		○										
	Full PIT (E2)		○										
	Full PIT (E3)		○										
S.S.1-9-2	Operation mode	Run			Clean-out			Run			Clean-out		
	Partial PIT	△			○	△		△			△		
	Full PIT (E1)		○										
	Full PIT (E2)		○										
	Full PIT (E3)		○										
S.S.1-10-2	Operation mode	Run		F	Run	Clean-out			Run	F	Run	Clean-out	
	Partial PIT	△			△		△					△	
	Full PIT (E1)		○										
	Full PIT (E2)		○										
	Full PIT (E3)		○										

F : Flush-out

E1 : Accuracy of unmeasured inventories is assumed 20 %

E2 : Accuracy of unmeasured inventories is assumed 10 %

E3 : Accuracy of unmeasured inventories is assumed 5 %

A symbol "○" shows an initial alarm, and

A symbol "△" shows a false alarm generated in the simulation run of no diversion.

Table 5.20 Alarm Generation Chart for each Diversion Mode; NDA of 20% accuracy is assumed for in-process inventory KMP, D₁

Diversion Rate	Simulation Study Case	Day Diversion mode	Day												
			20	40	60	80	100	120	140	160	180	200	220		
8 kgs per year	S.S.1-5-1	Operation mode	Processing Run												Clean-out
		Uniform Div.	△		o							△	△		
		Random Div.	△			o o		o		o o		△	△		
	Single Div.	△			o				o		△	△			
	S.S.1-8	Operation mode	Run	F	Run	F	Run	F	Run	F	Run	Clean-out			
		Uniform Div.	△		o							△			
		Random Div.	△						o			△			
	Single Div.	△			o o o						△				
	S.S.4	Operation mode	Run	F	Run	F	Run	F	Run	F	Run	Clean-out			
Uniform Div.		△		o							△				
Random Div.		△	o		o o				o		△				
Single Div.	△			o						△					
1 $\bar{\sigma}$ MUFd per NRTMBP	S.S.1-5-1	Operation mode	Processing Run												Clean-out
		Uniform Div.	△		o							△	△		
		Random Div.	△		o	o o			o			△	△		
	Single Div.	△				o o o o					△	△			
	S.S.1-8	Operation mode	Run	F	Run	F	Run	F	Run	F	Run	Clean-out			
		Uniform Div.	△			o						△			
		Random Div.	△	o		o o o				o		△			
	Single Div.	△				o o					△				
	S.S.4	Operation mode	Run	F	Run	F	Run	F	Run	F	Run	Clean-out			
Uniform Div.		△		o							△				
Random Div.		△	o			o			o o o		△				
Single Div.	△			o o o						△					

F : Flush-out

A symbol "o" shows an alarm for Random and Single diversion, and for Uniform diversion shows an initial alarm, and A symbol "△" shows a false alarm generated in the simulation run of no diversion.

S.S.1-1

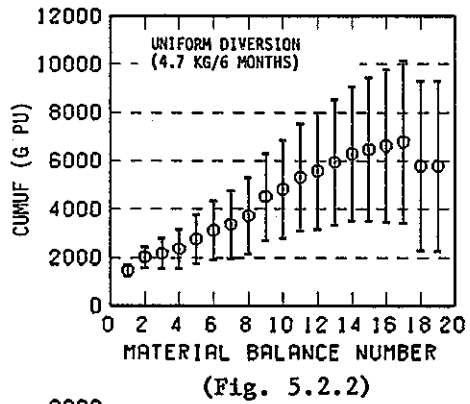
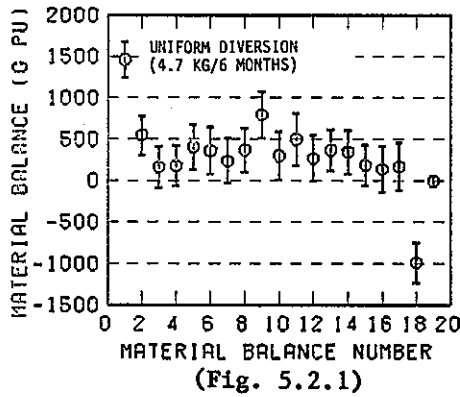
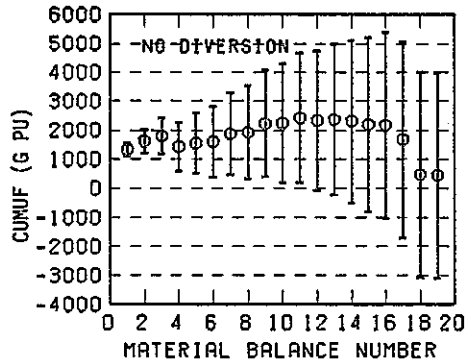
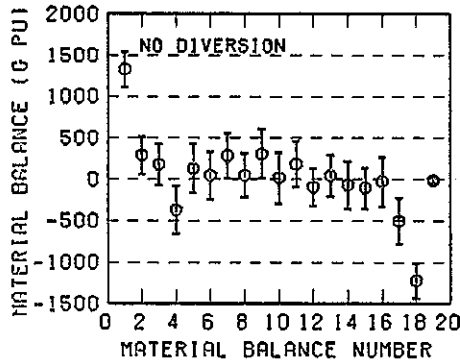

S.S.1-2

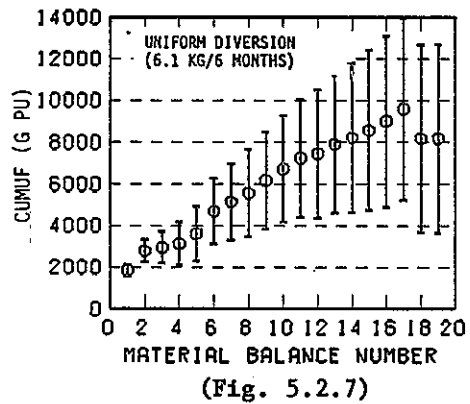
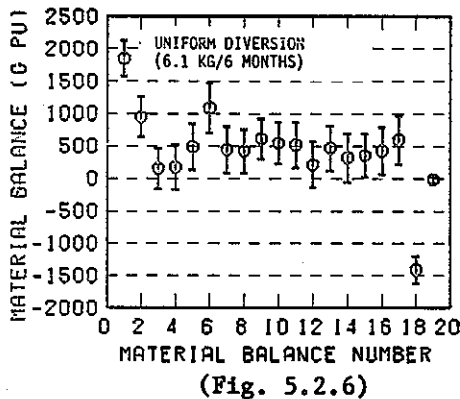
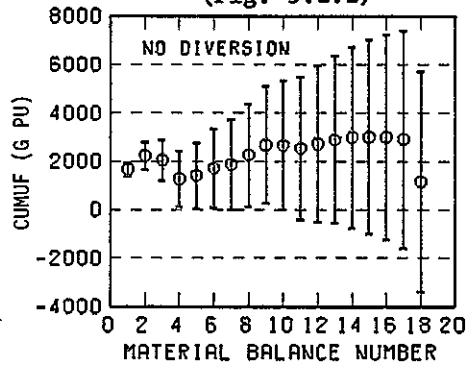
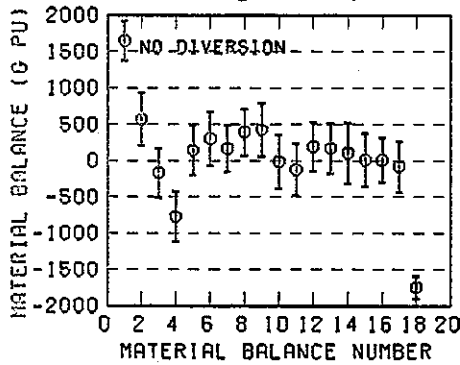
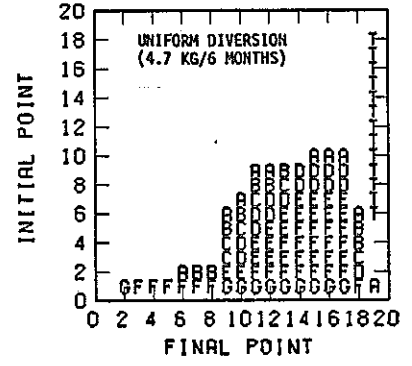
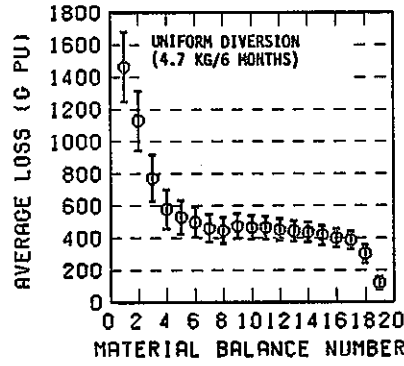
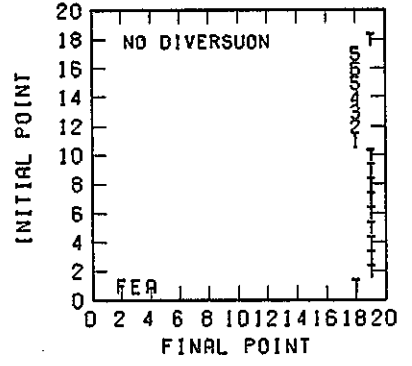
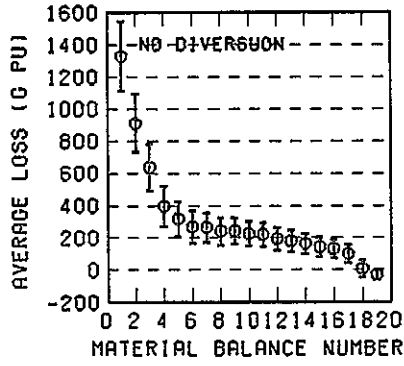
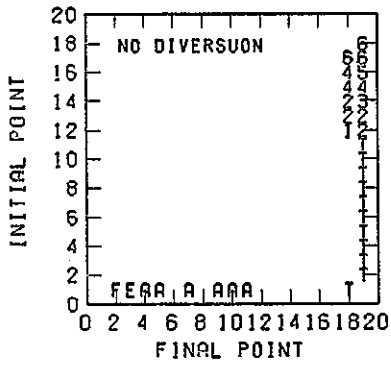

Fig. 5.2 CUMUF and uniform diversion tests for S.S.1-1 and S.S.1-2; Simulation period; 6 months.



(Fig. 5.2.3)

(Fig. 5.2.4)

(Fig. 5.2.5)

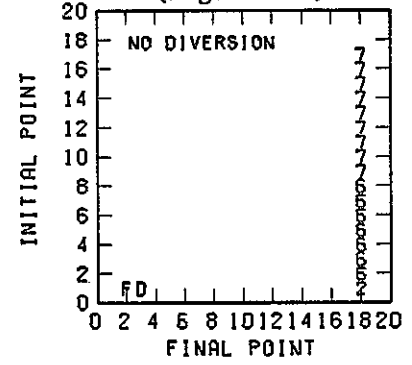
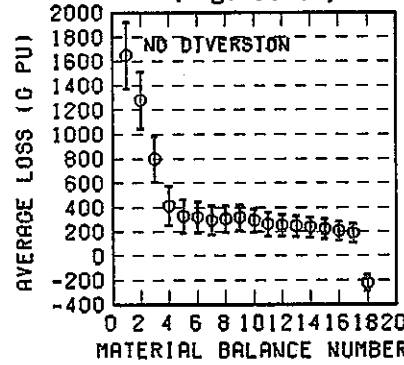
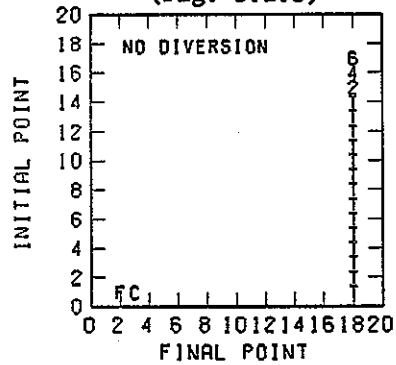

(Fig. 5.2.8)

(Fig. 5.2.9)

(Fig. 5.2.10)

S.S.1-3

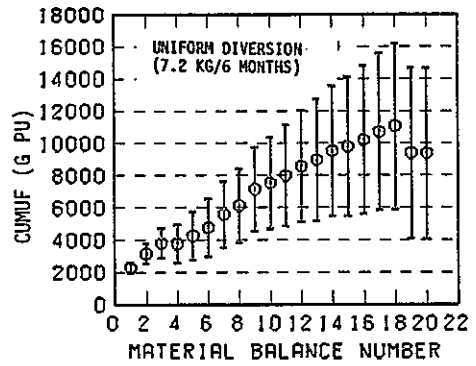
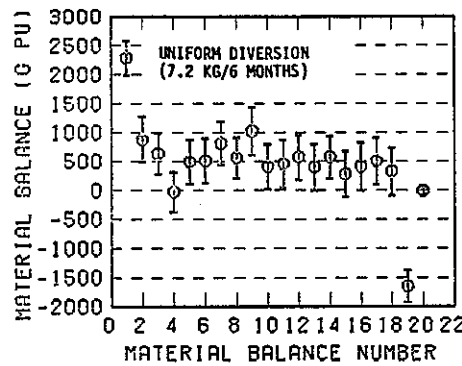
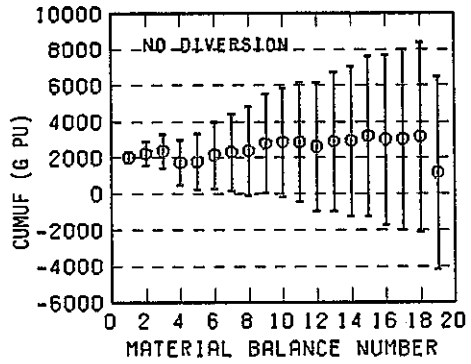
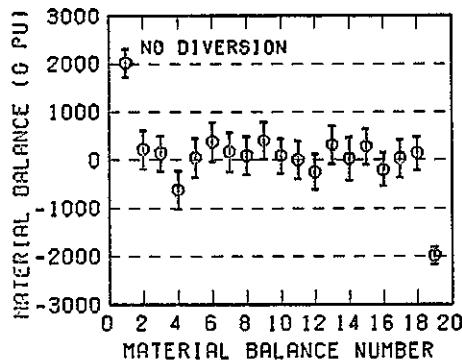

S.S.1-4

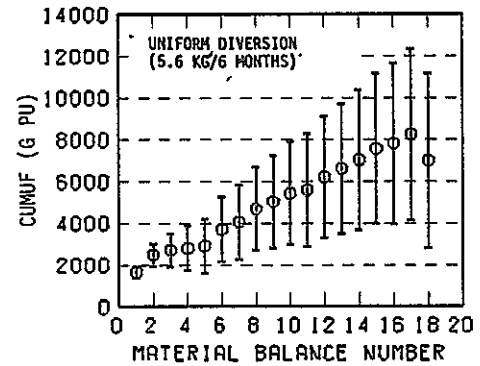
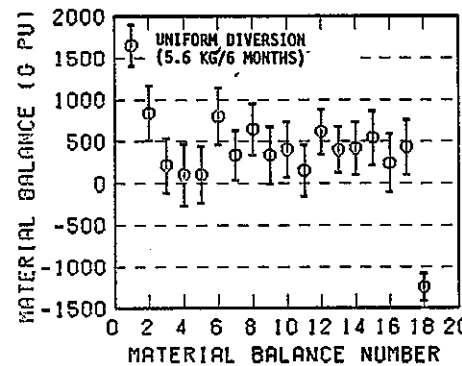
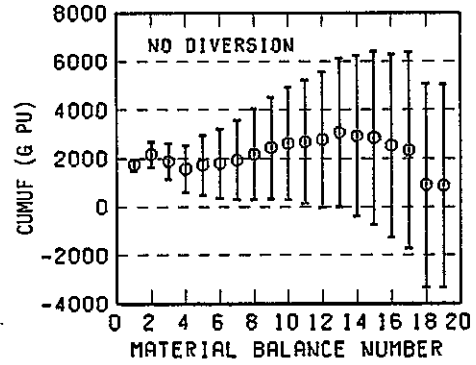
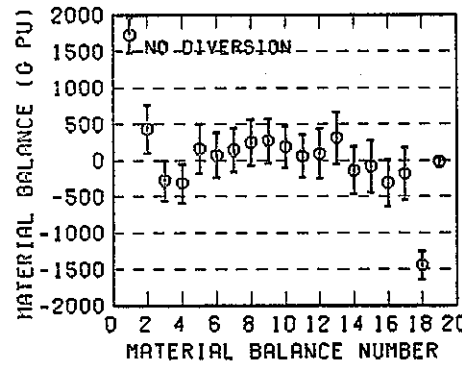
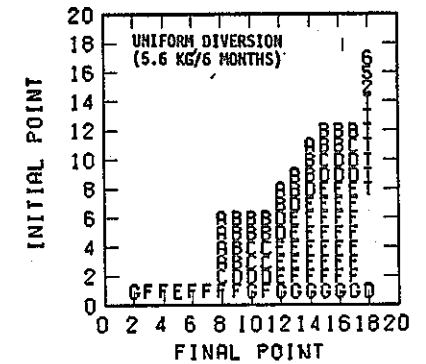
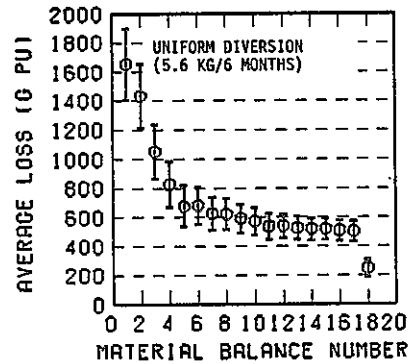
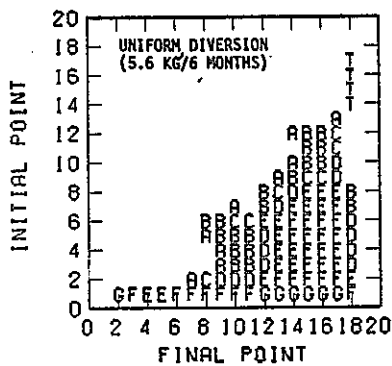
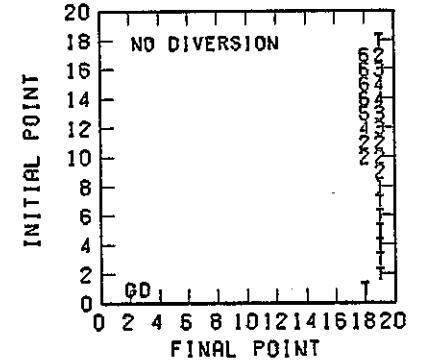
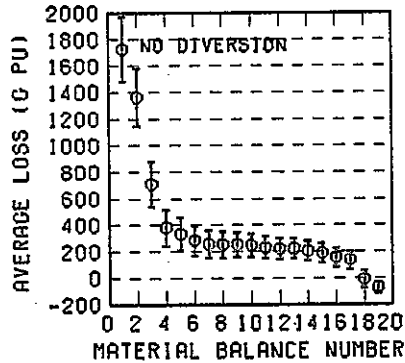
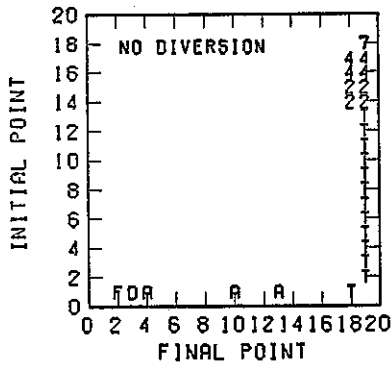
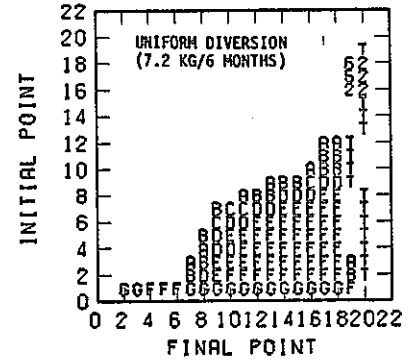
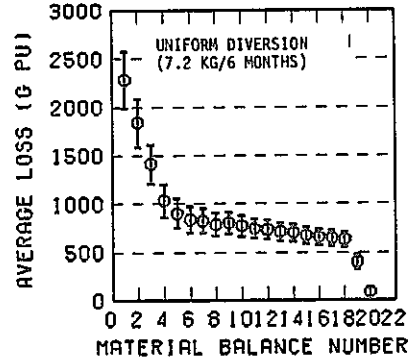
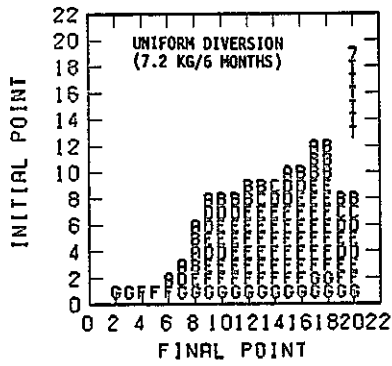
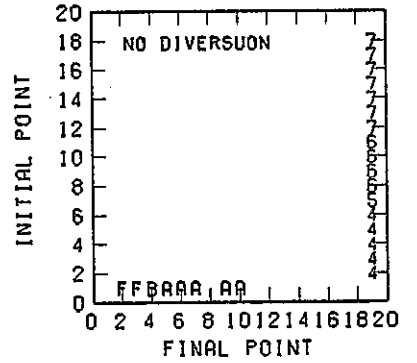
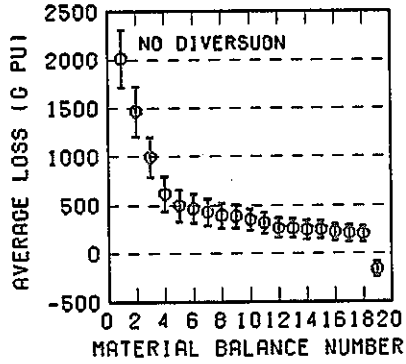
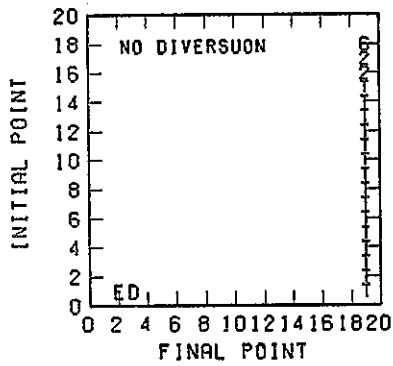
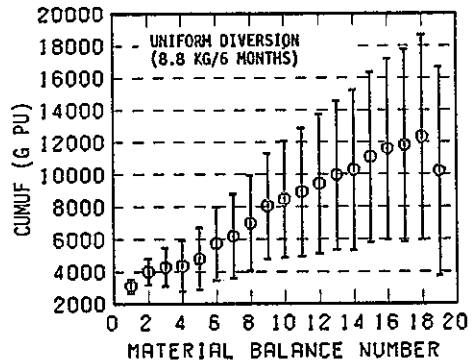
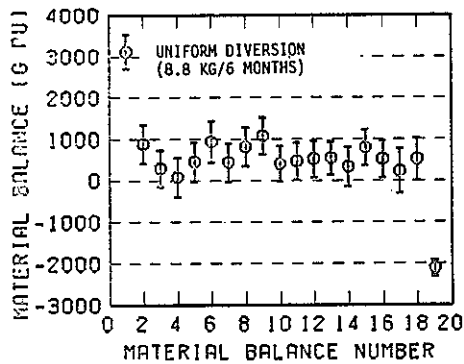
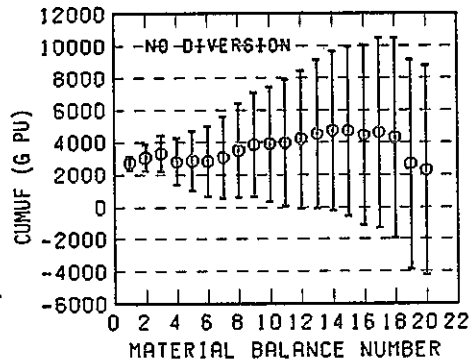
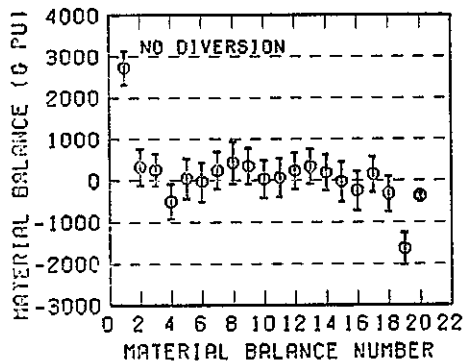

Fig. 5.3 CUMUF and uniform diversion tests for S.S.1-3 and S.S.1-4; Simulation period; 6 months.



S.S.1-5-1



S.S.1-6

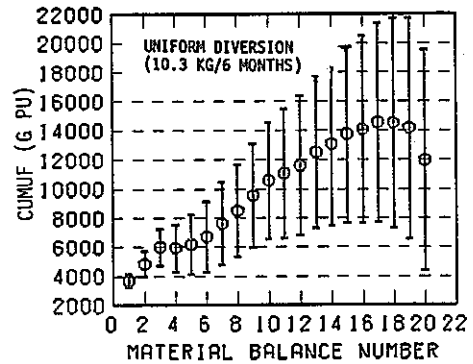
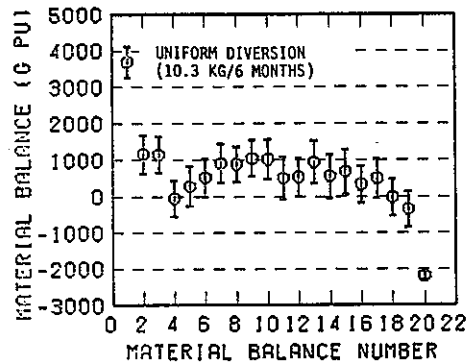
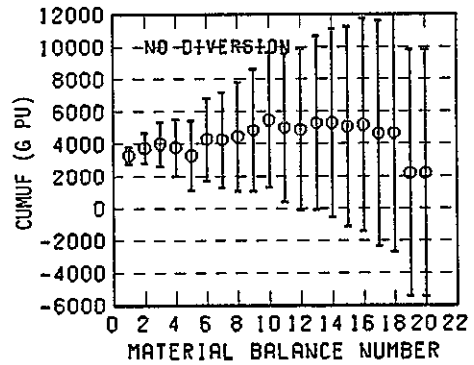
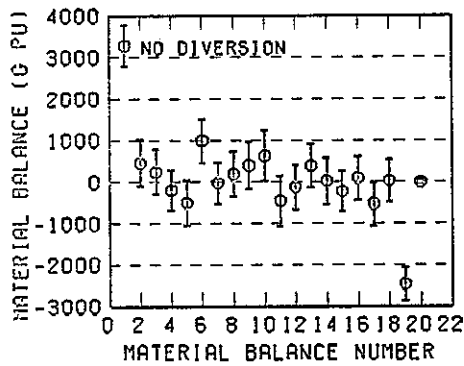
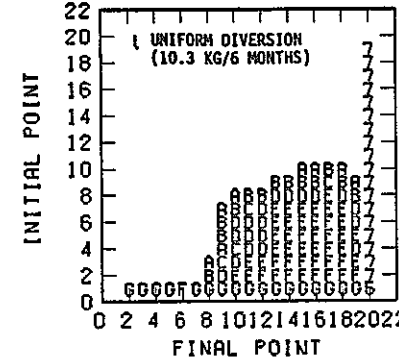
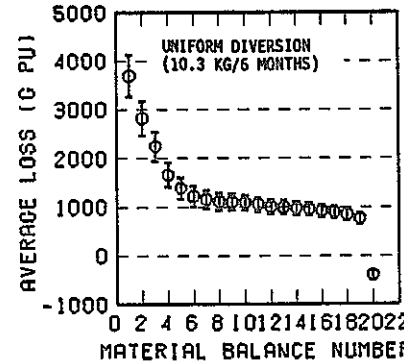
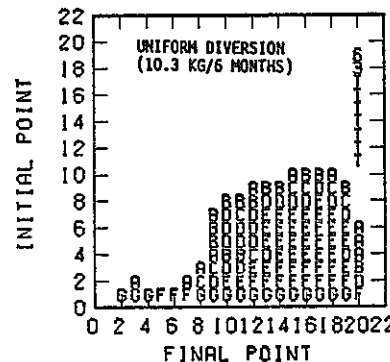
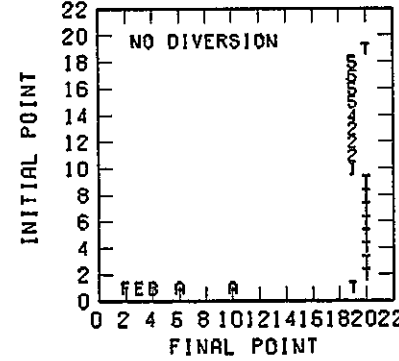
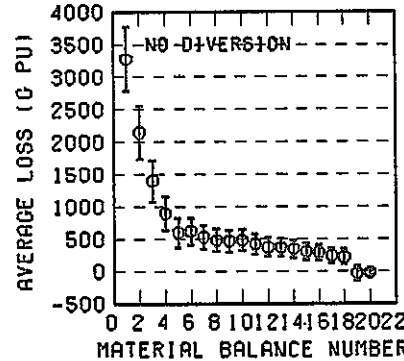
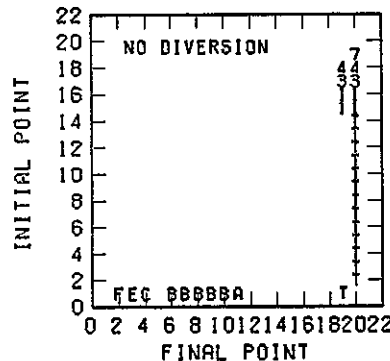
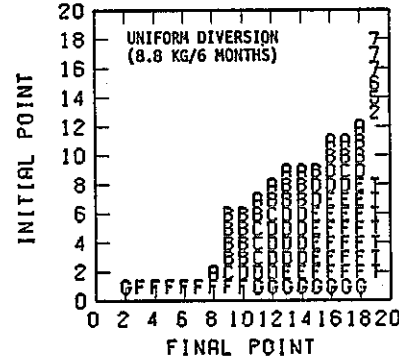
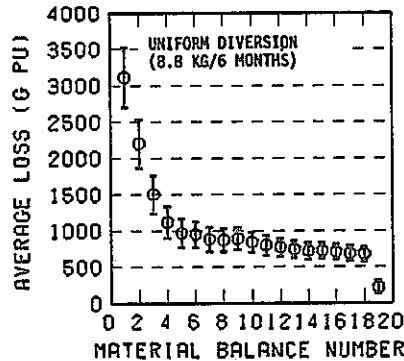
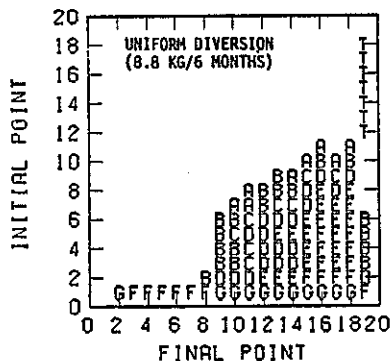
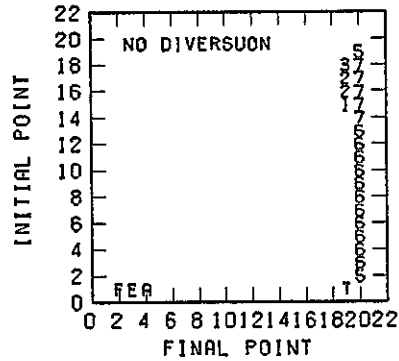
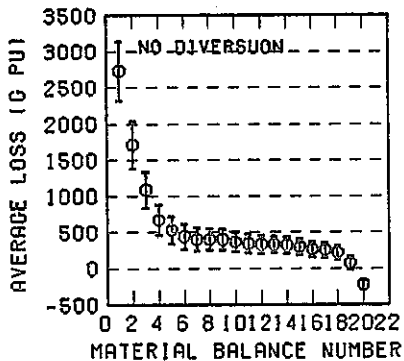
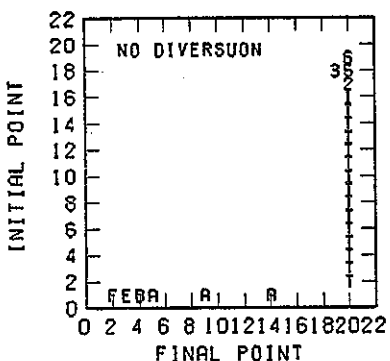
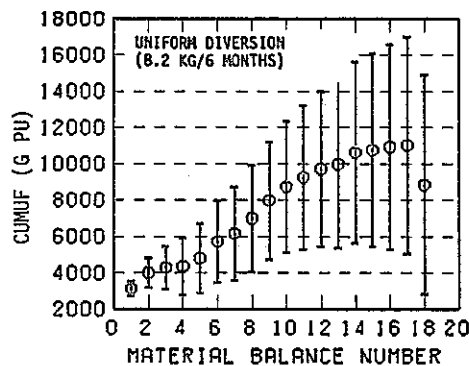
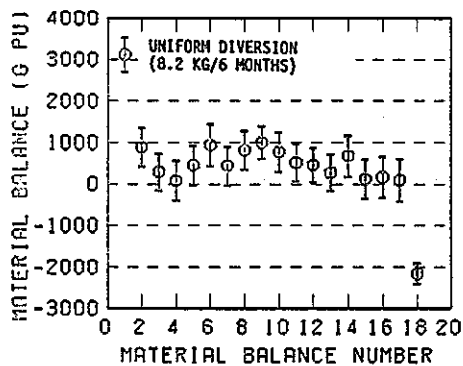
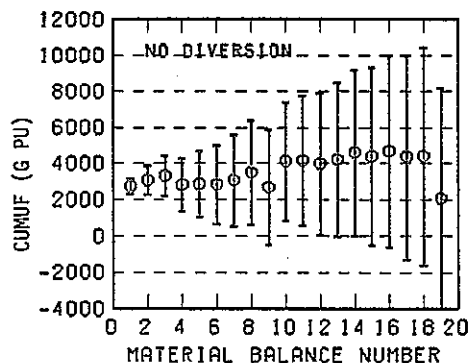
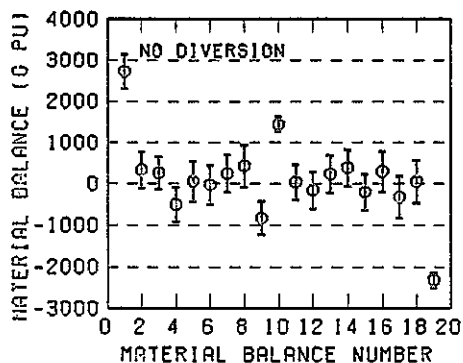

Fig. 5.4 CUMUF and uniform diversion tests for S.S.1-5-1 and S.S.1-6; Simulation period; 6 months.



S.S.1-7



S.S.1-8

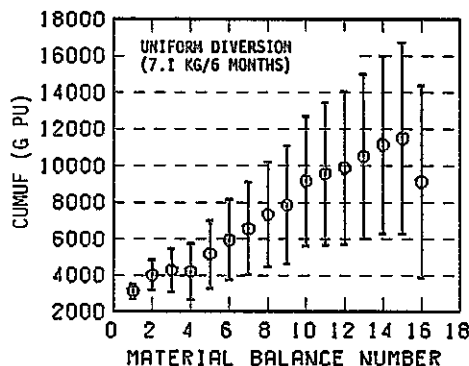
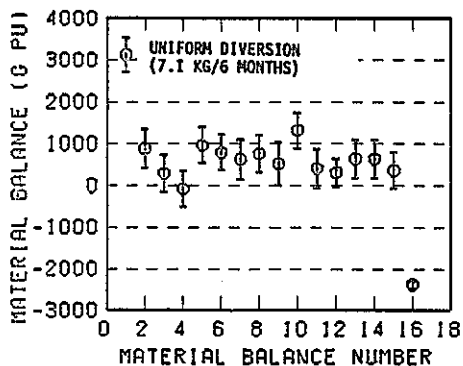
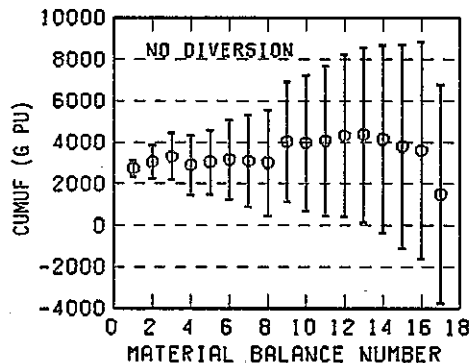
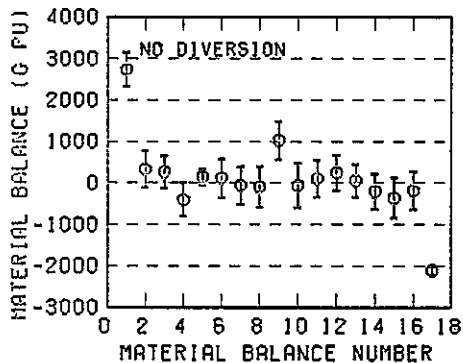
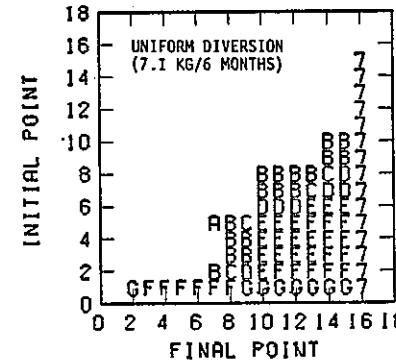
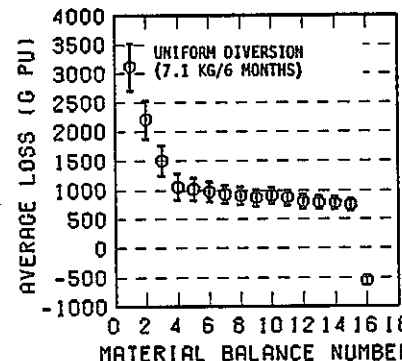
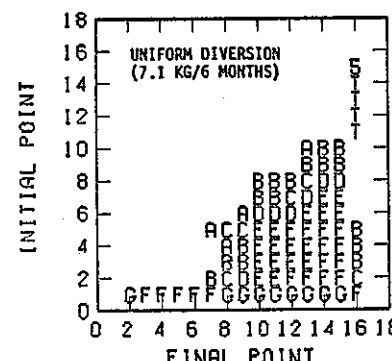
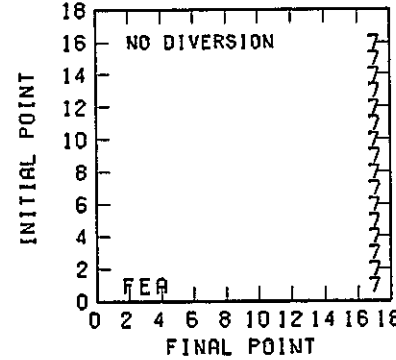
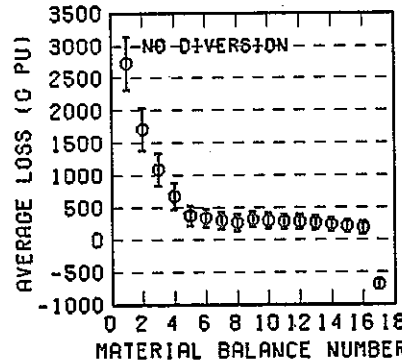
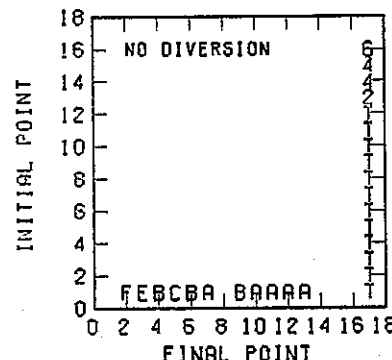
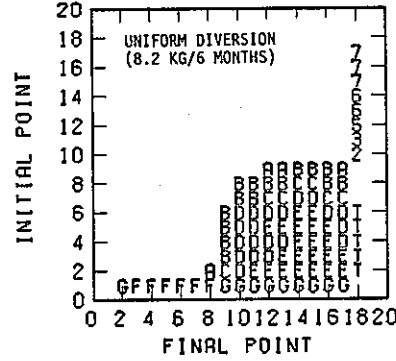
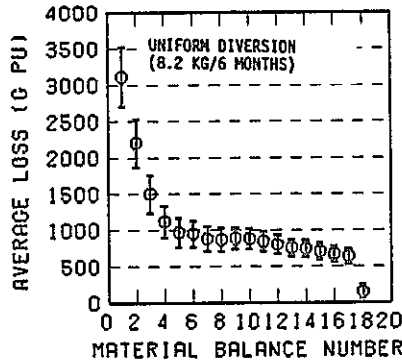
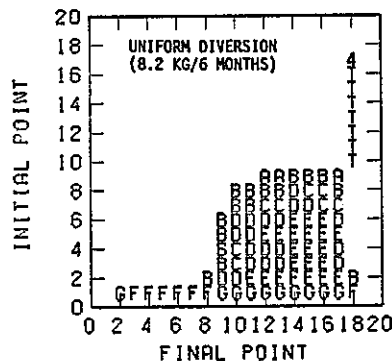
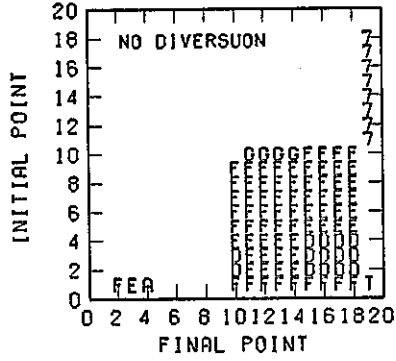
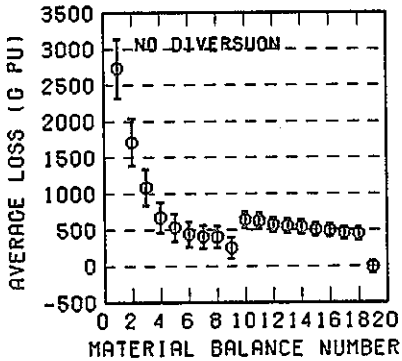
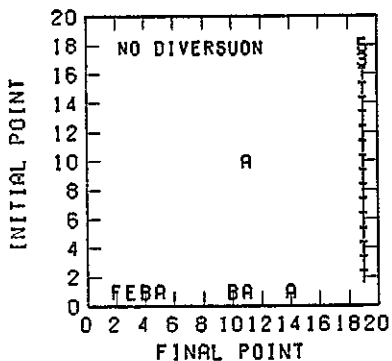
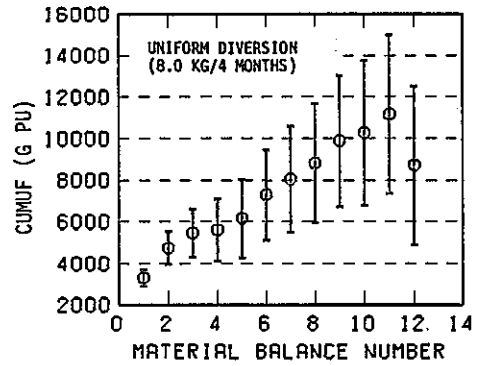
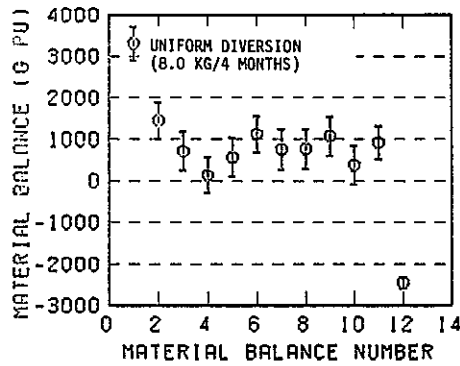
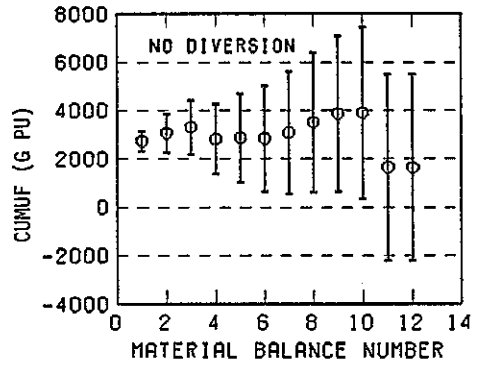
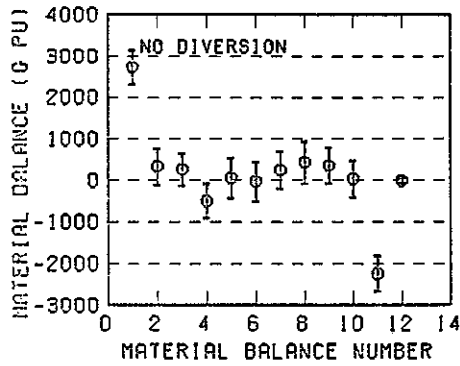

Fig. 5.5 CUMUF and uniform diversion tests for S.S.1-7 and S.S.1-8; Simulation period; 6 months.



S.S.1-9



S.S.1-10

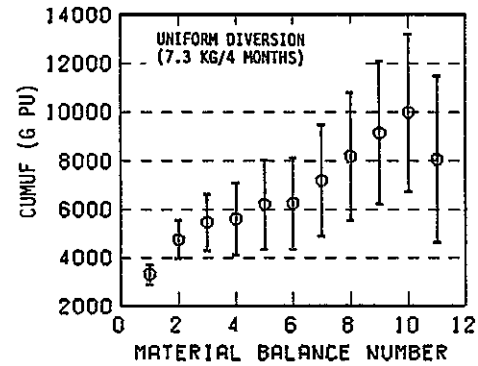
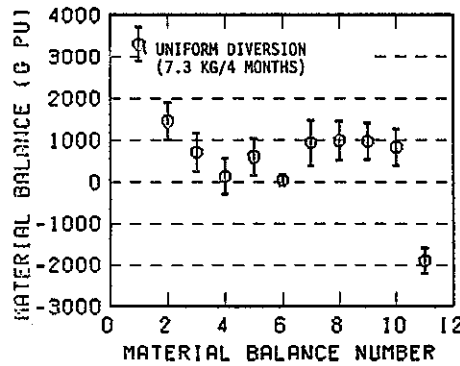
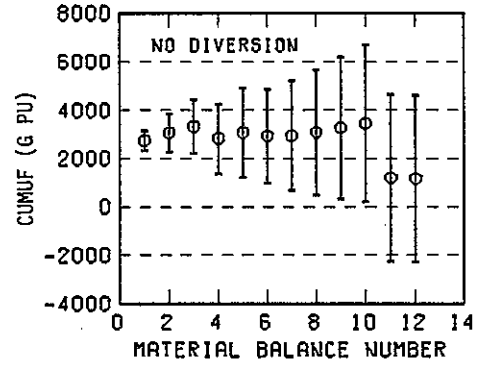
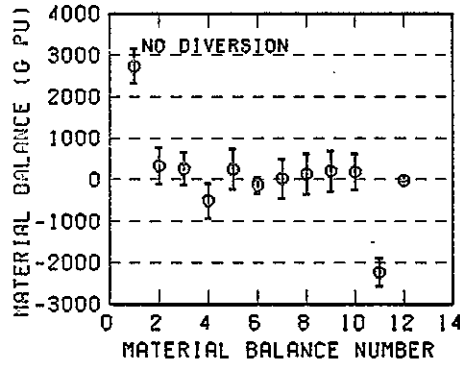
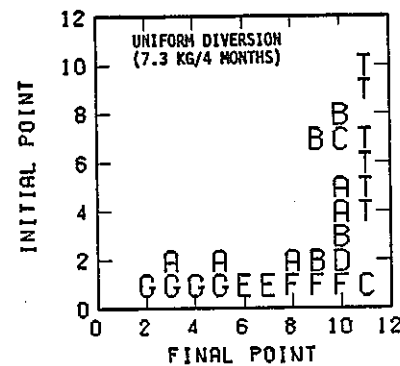
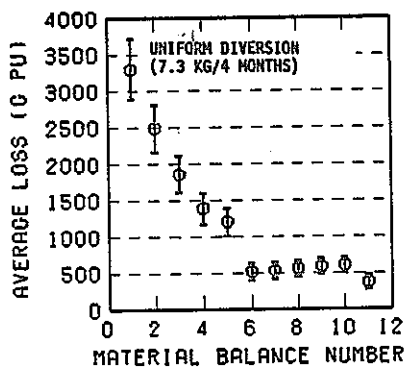
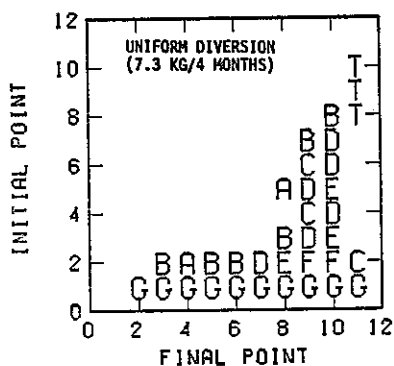
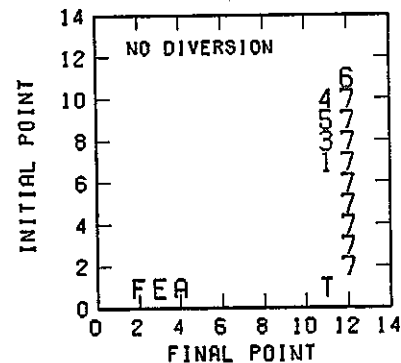
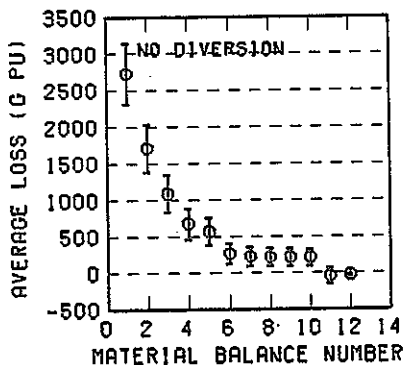
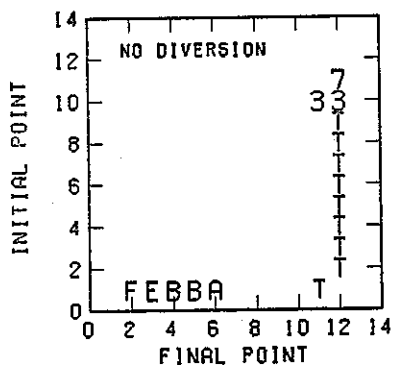
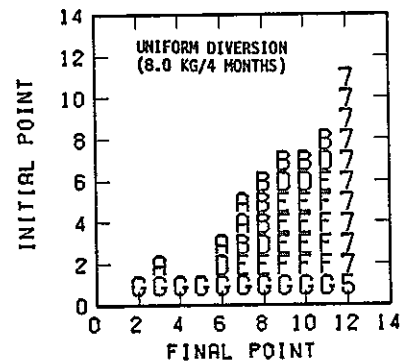
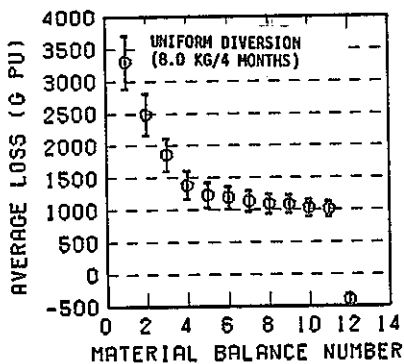
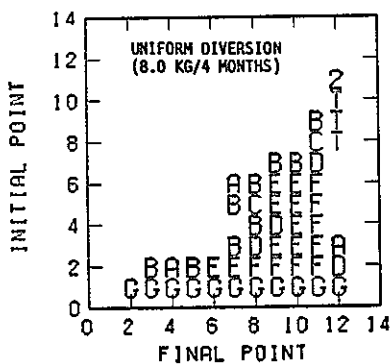
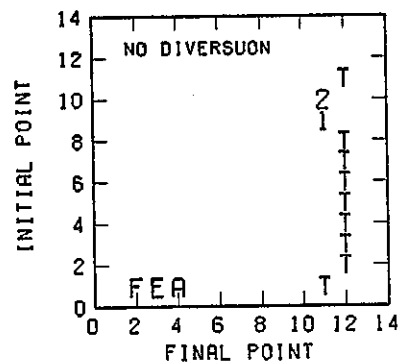
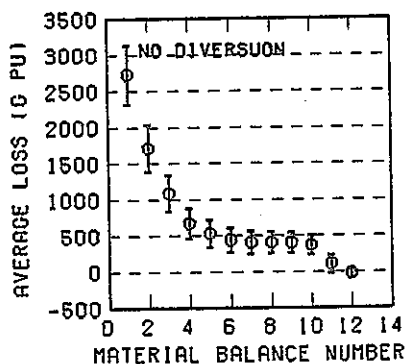
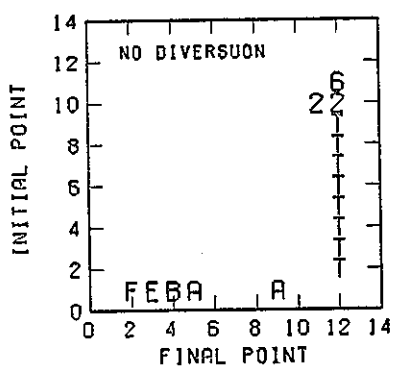

Fig. 5.6 CUMUF and uniform diversion tests for S.S.1-9 and S.S.1-10; Simulation period; 4 months.



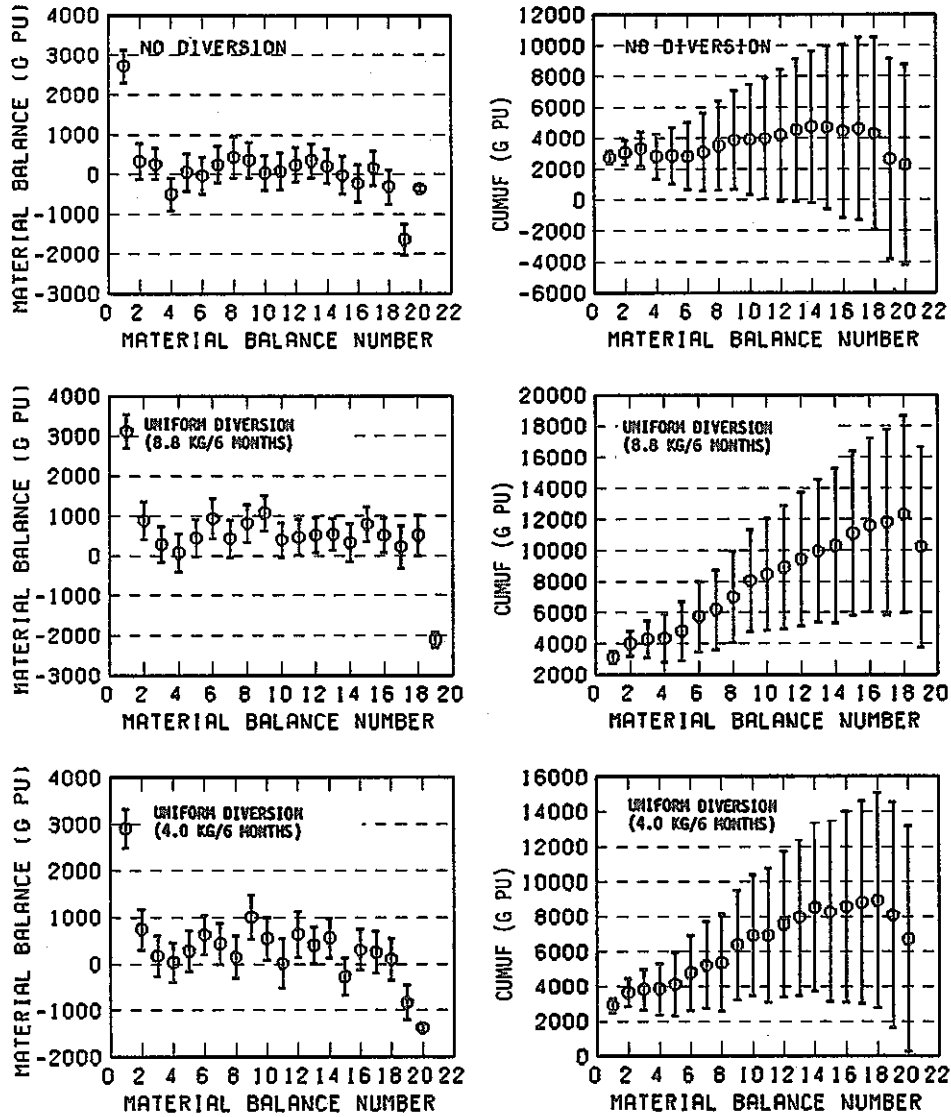
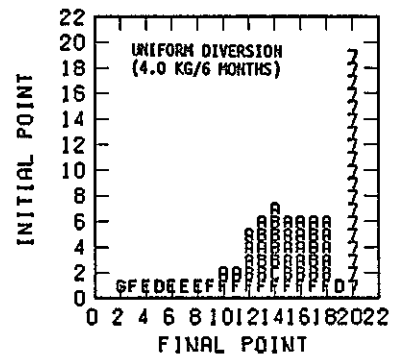
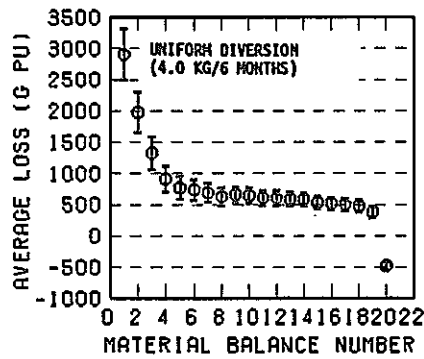
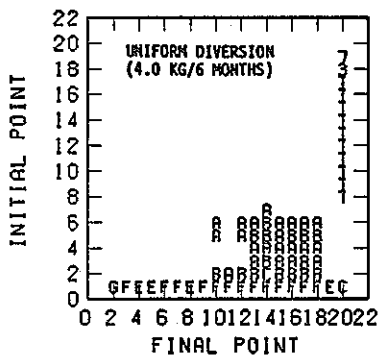
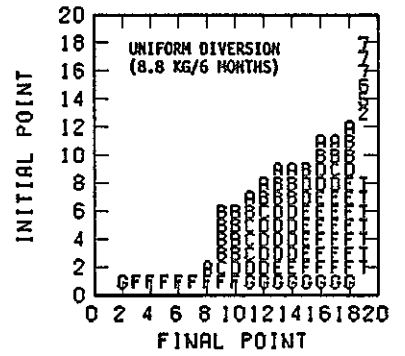
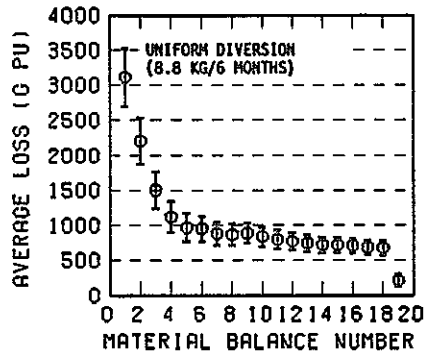
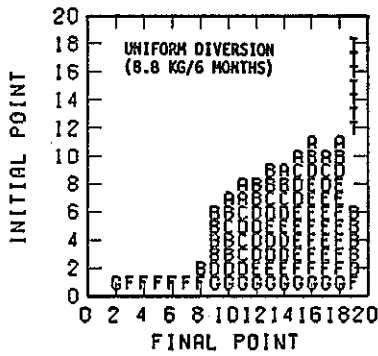
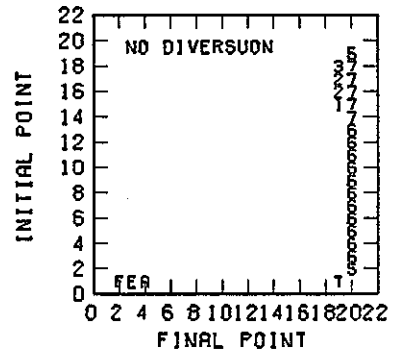
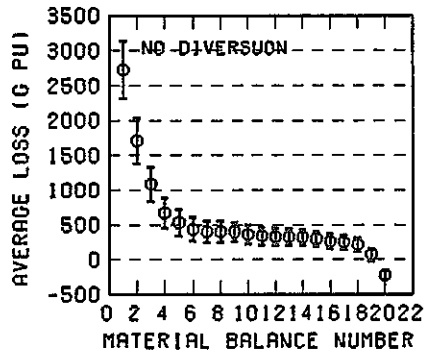
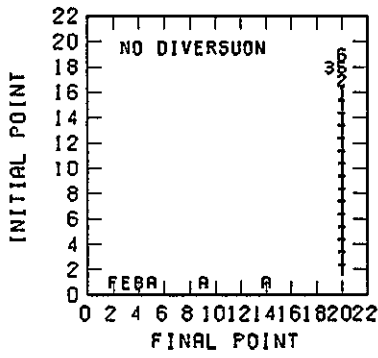

Fig. 5.7 CUMUF and uniform diversion tests for S.S.1-5-1 with different diversion ratio; Simulation period; 6 months.



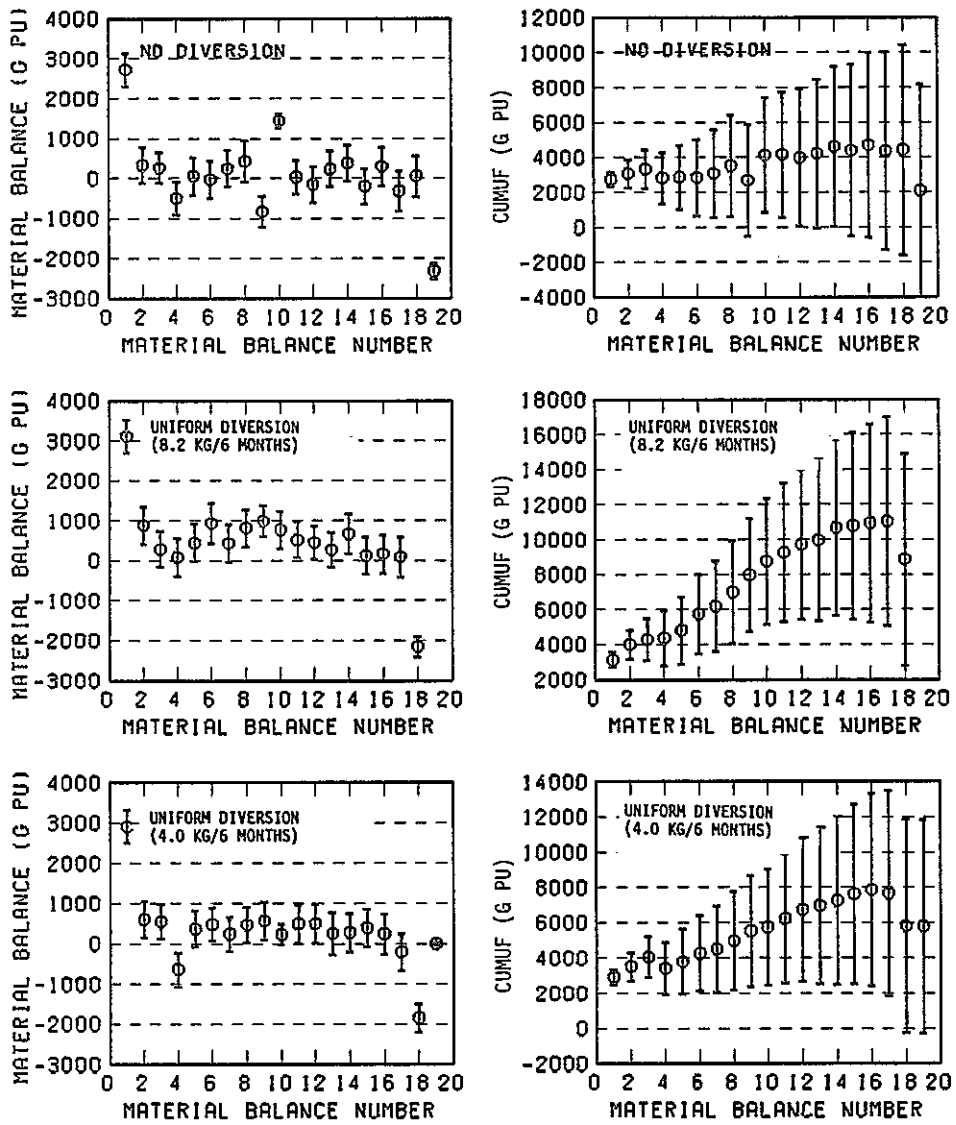
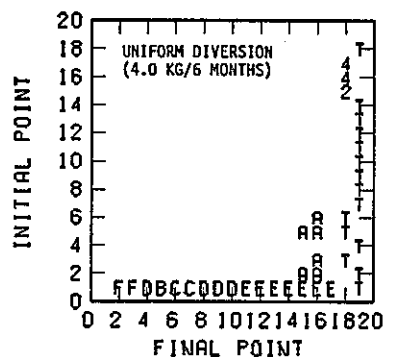
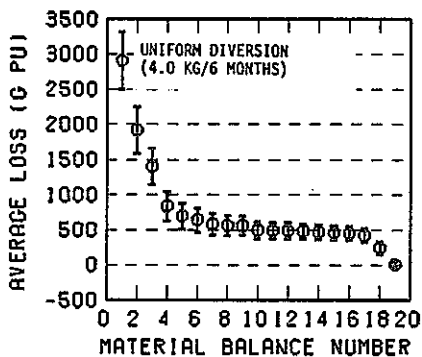
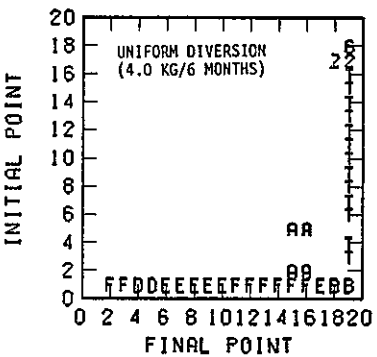
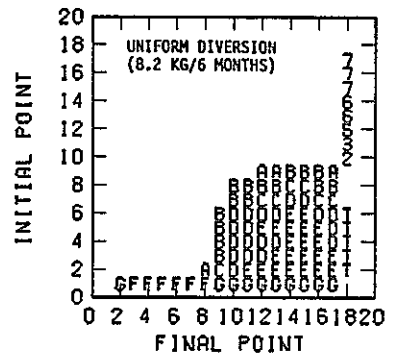
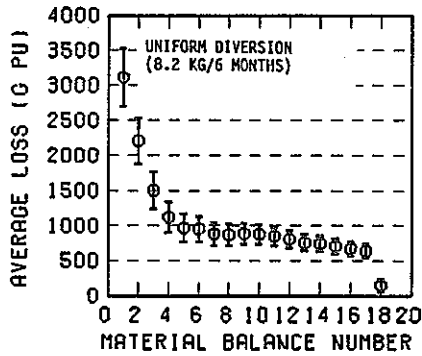
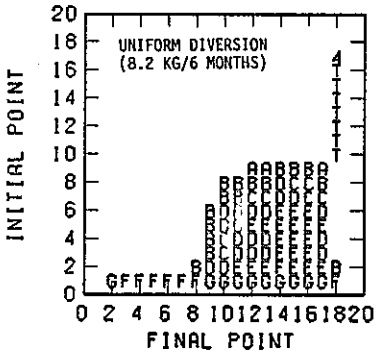
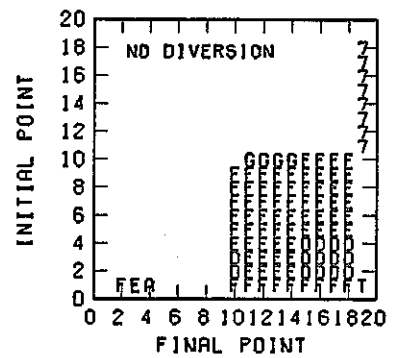
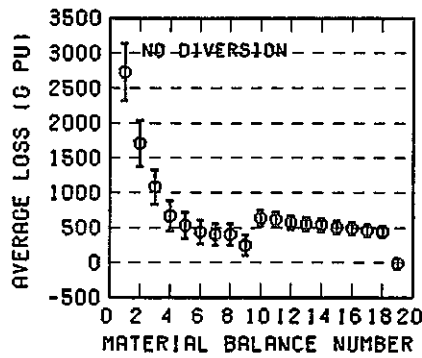
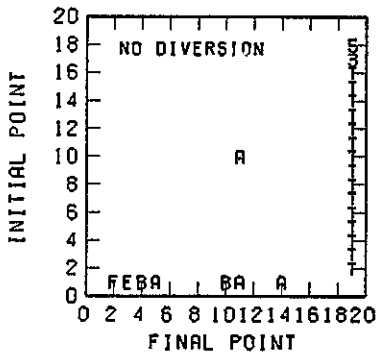

Fig. 5.8 CUMUF and uniform diversion tests for S.S.1-7 with different diversion ratio; Simulation period; 6 months.



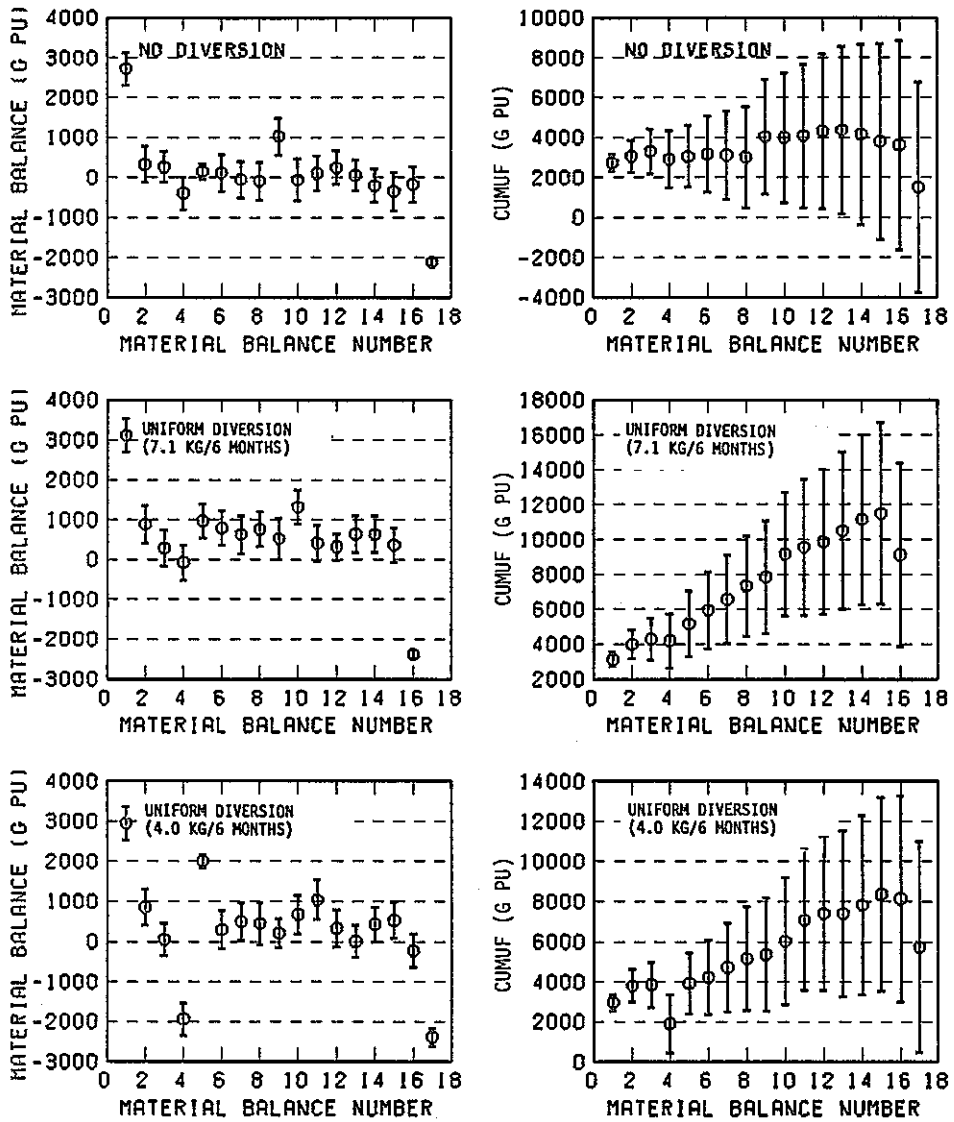
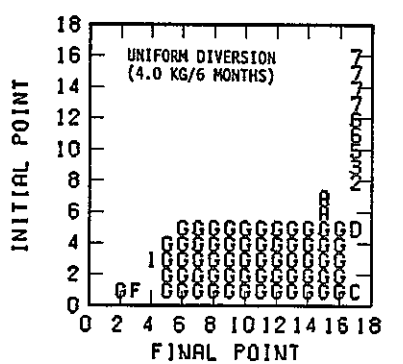
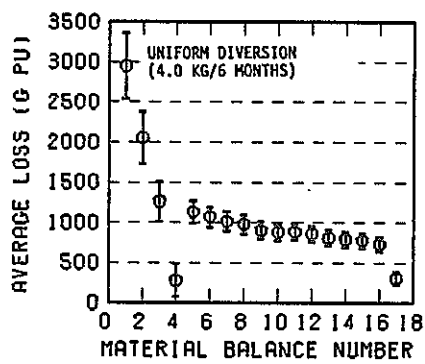
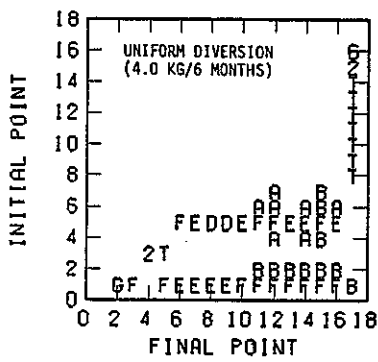
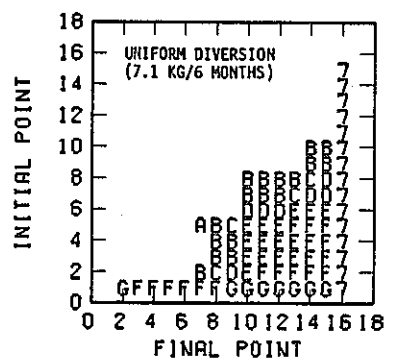
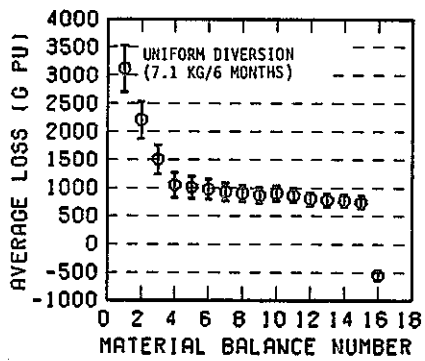
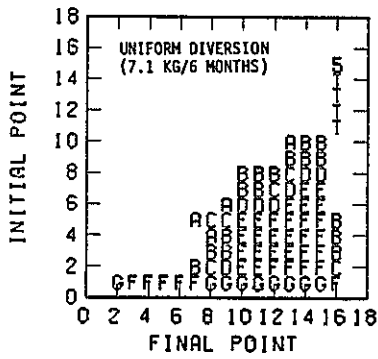
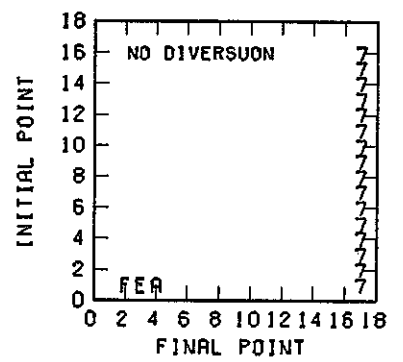
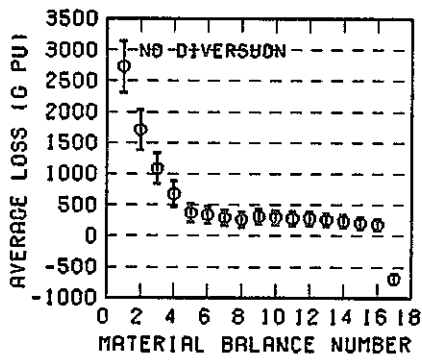
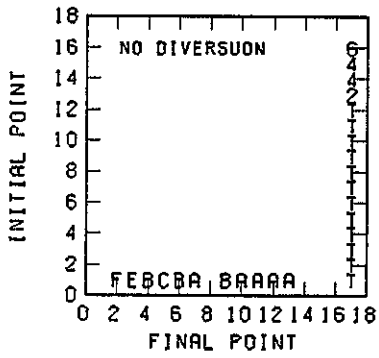

Fig. 5.9 CUMUF and uniform diversion tests for S.S.1-8 with different diversion ratio; Simulation period; 6 months.



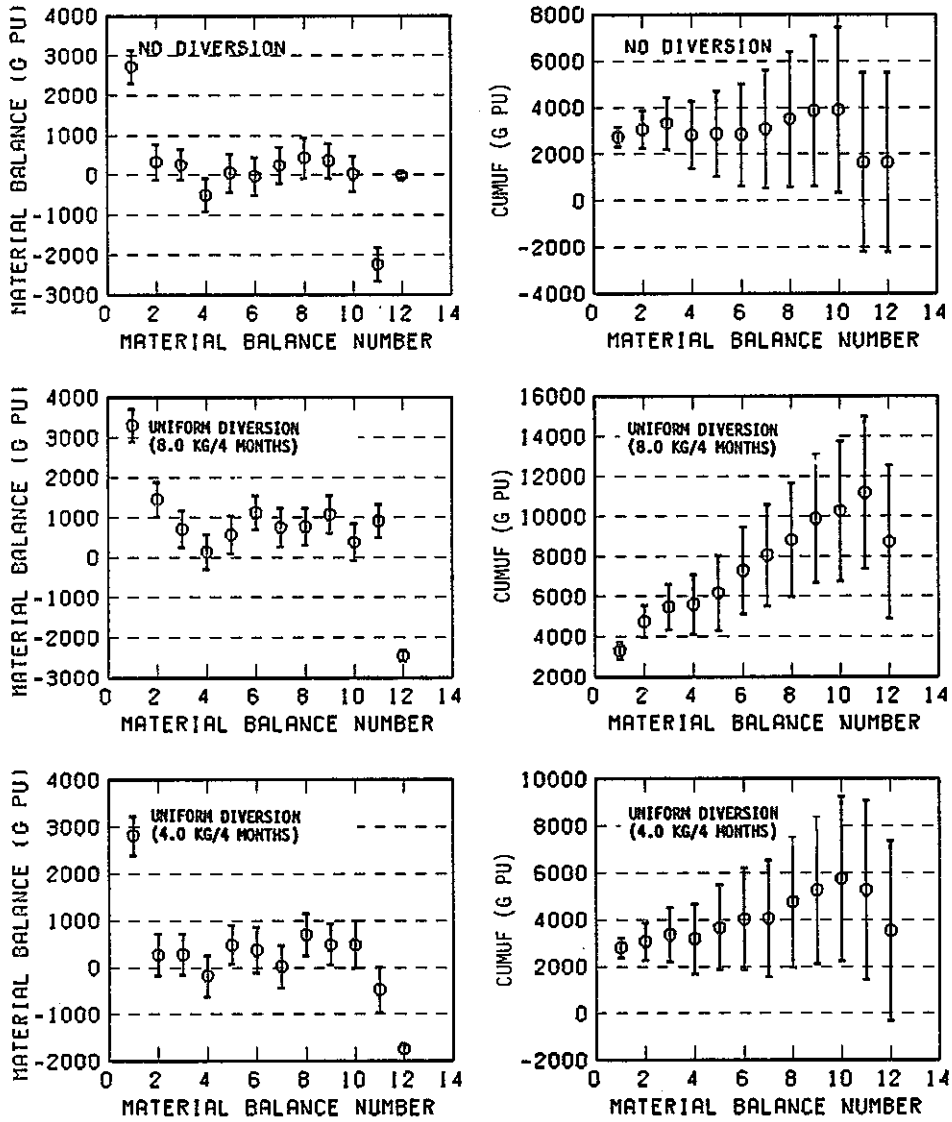
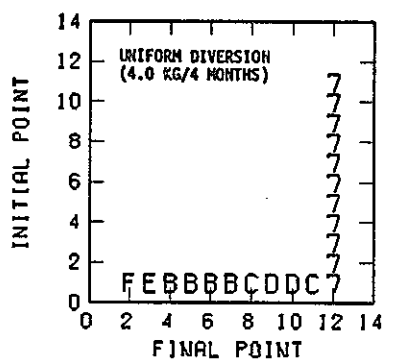
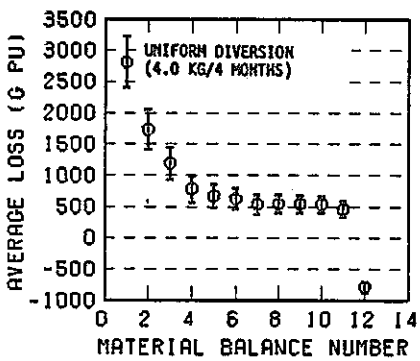
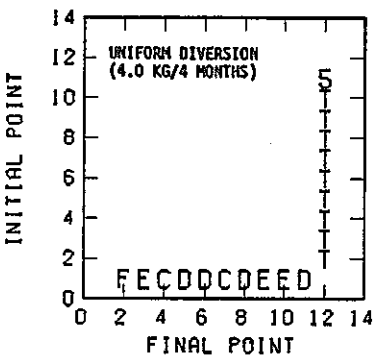
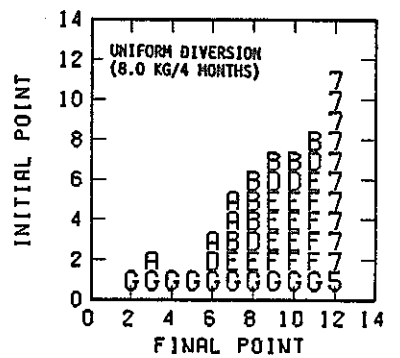
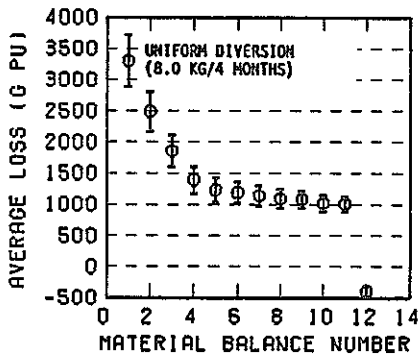
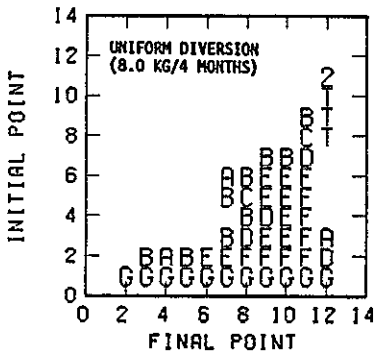
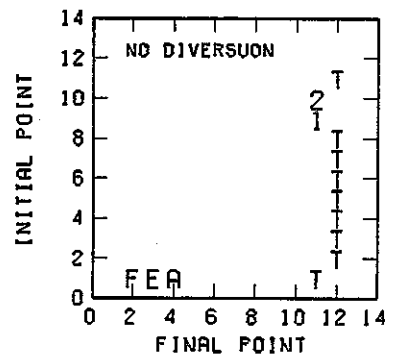
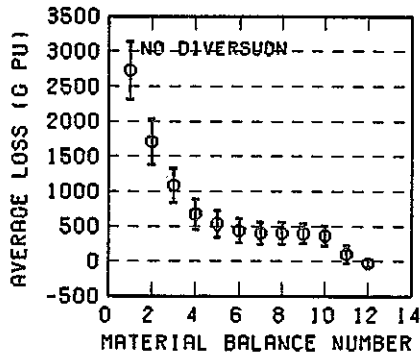
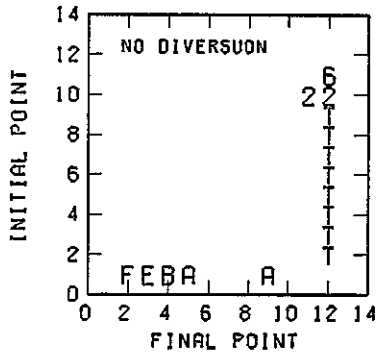

Fig. 5.10 CUMUF and uniform diversion tests for S.S.1-9 with different diversion ratio; Simulation period; 4 months.



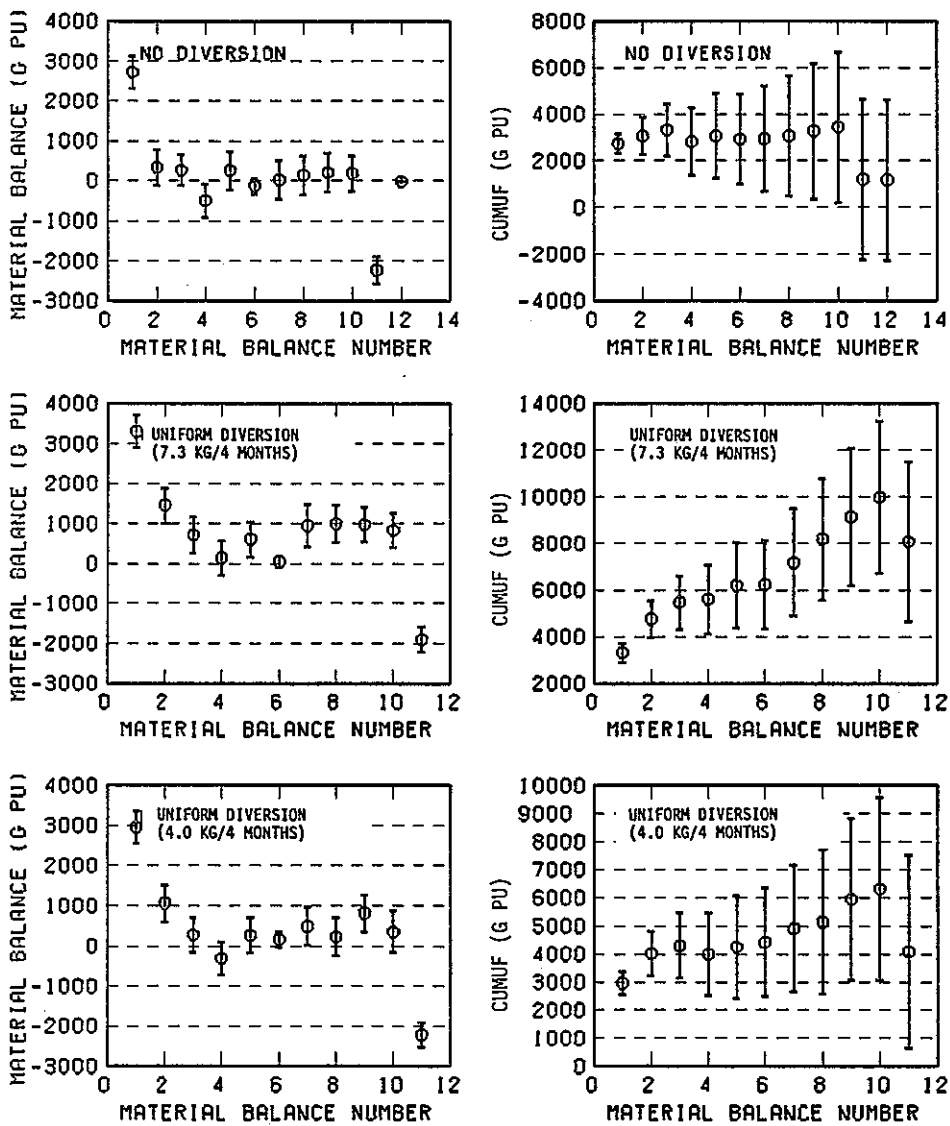
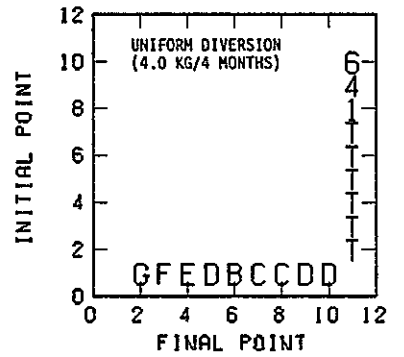
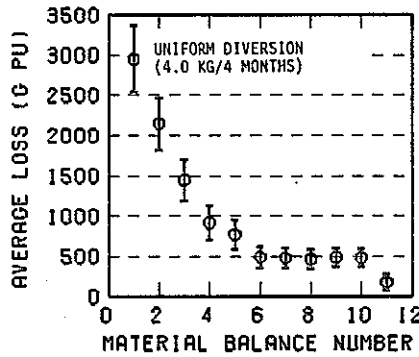
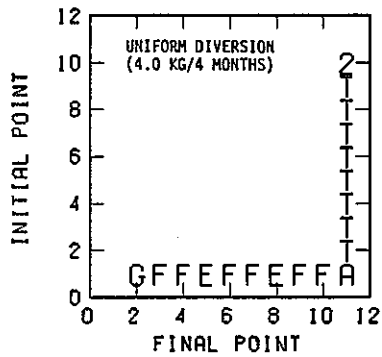
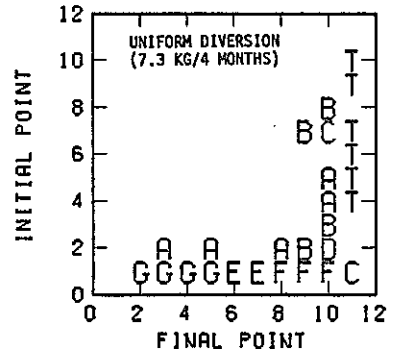
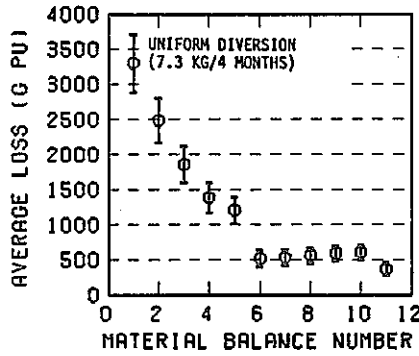
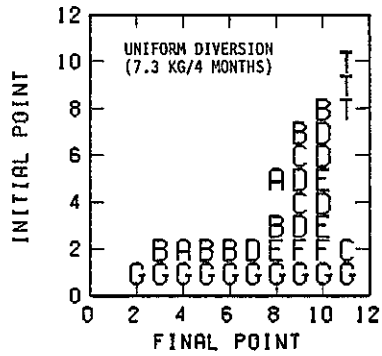
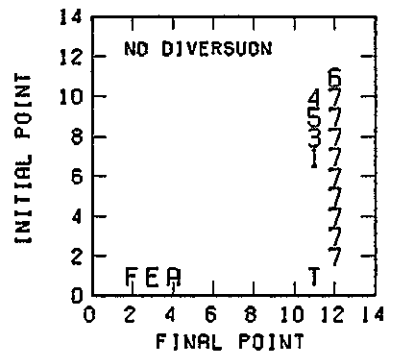
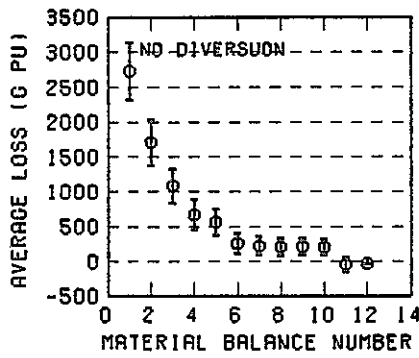
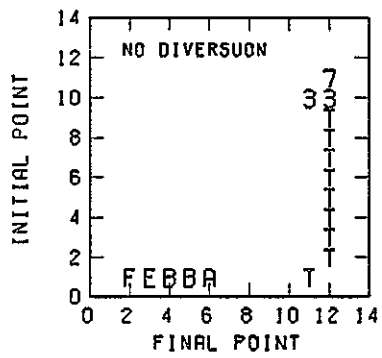

Fig. 5.11 CUMUF and uniform diversion tests for S.S.1-10 with different diversion ratio; Simulation period; 4 months.



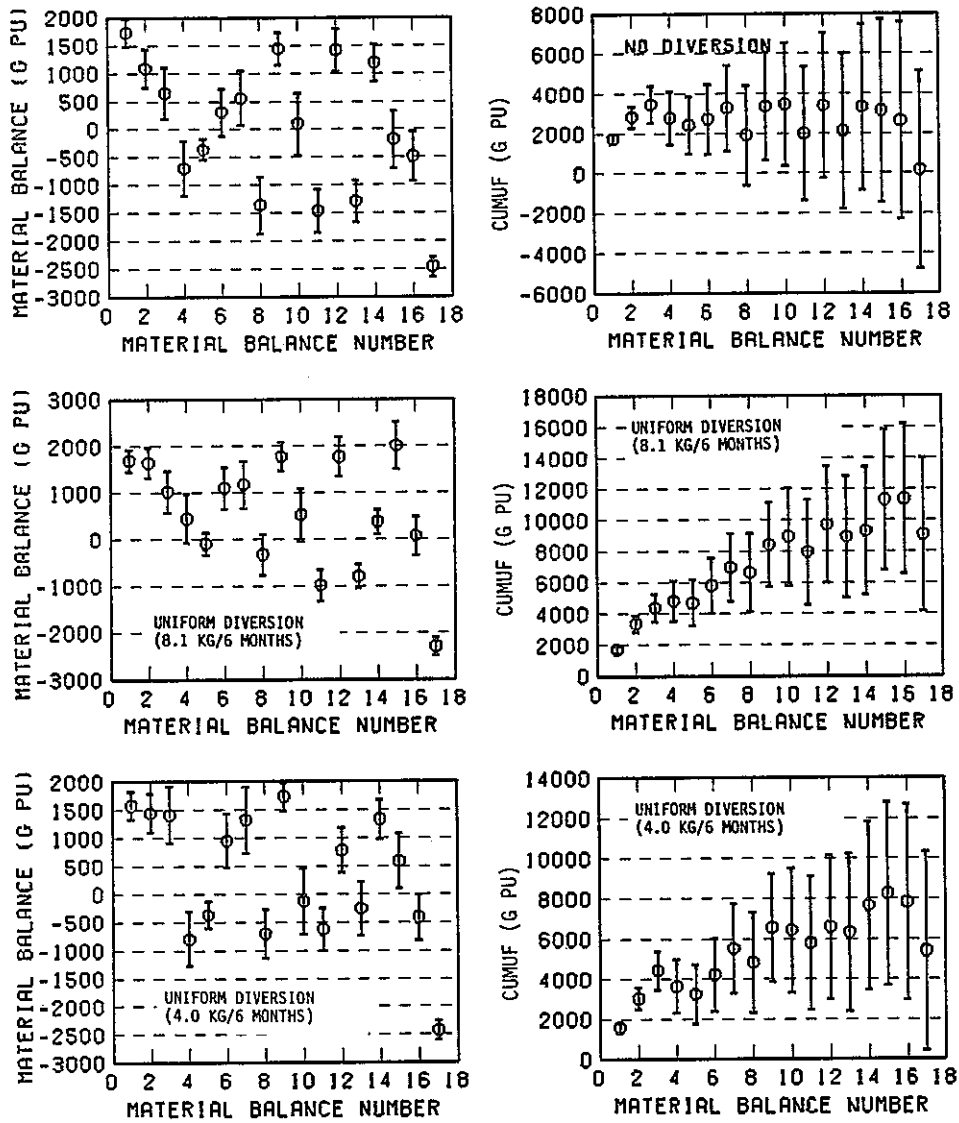
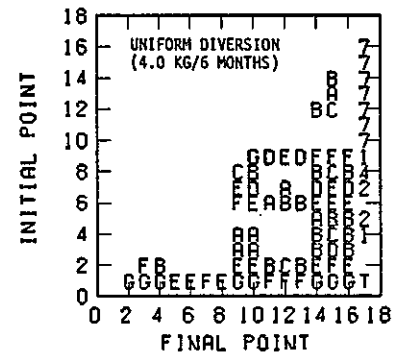
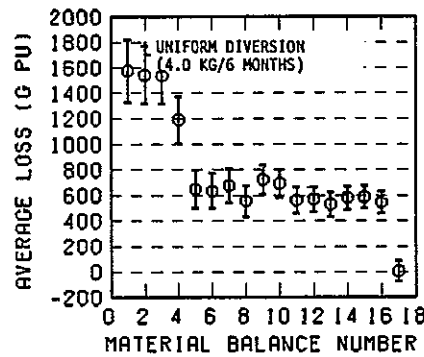
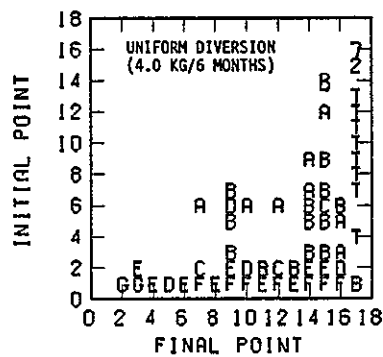
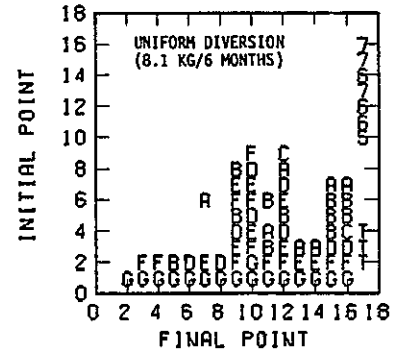
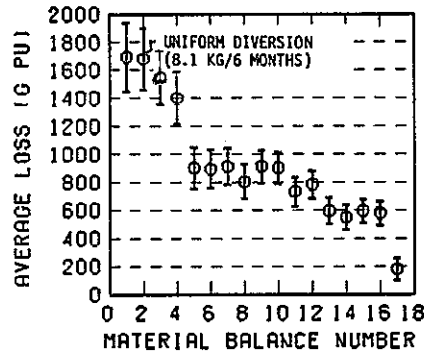
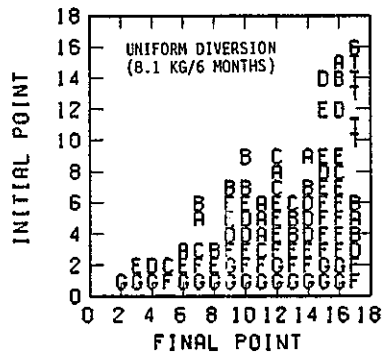
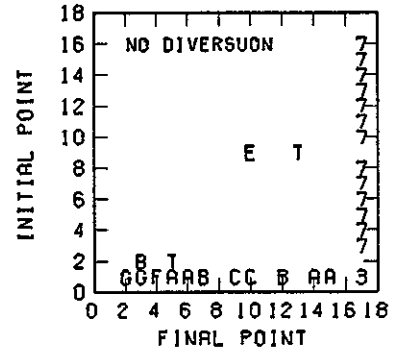
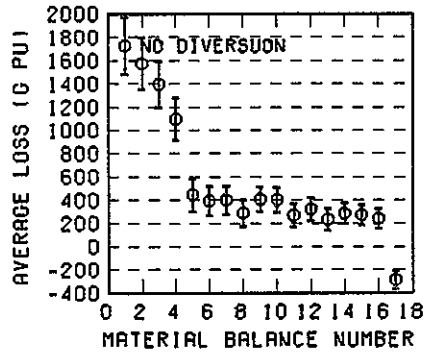
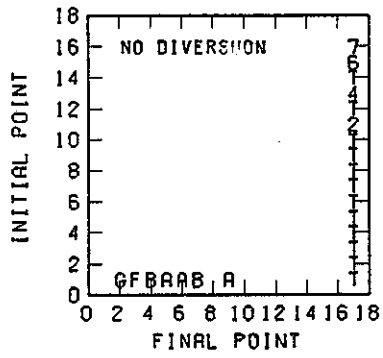
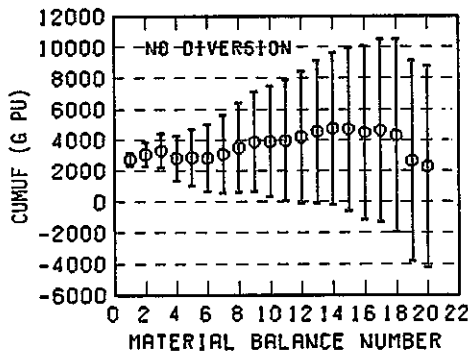
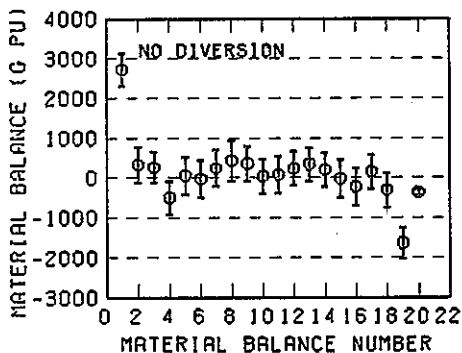

Fig. 5.12 CUMUF and uniform diversion tests for S.S.4 with different diversion ratio; Simulation periods; 6 months.



7 Day-N.R.T.
Material Balance
Period



14 Day-N.R.T.
Material Balance
Period

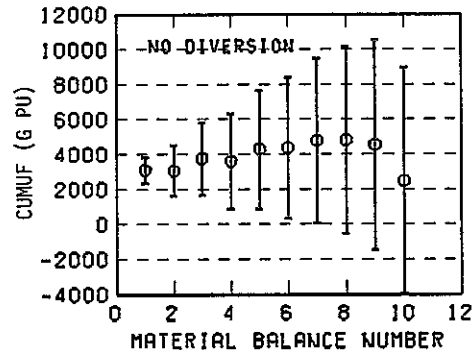
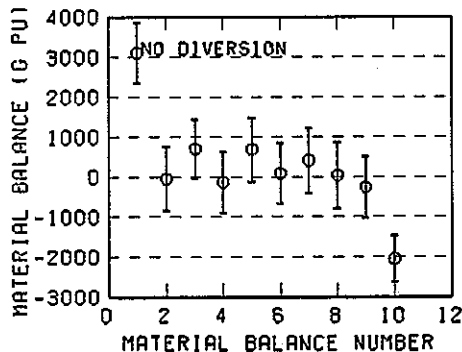

3 Day-N.R.T.
Material Balance
Period

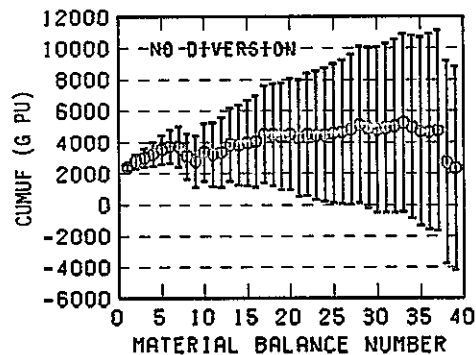
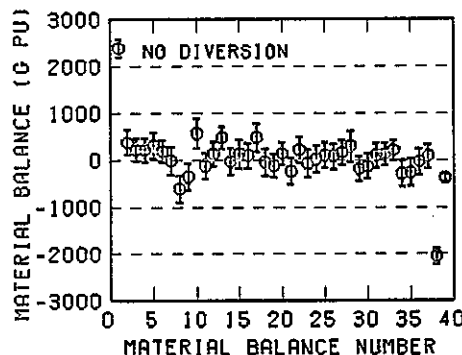
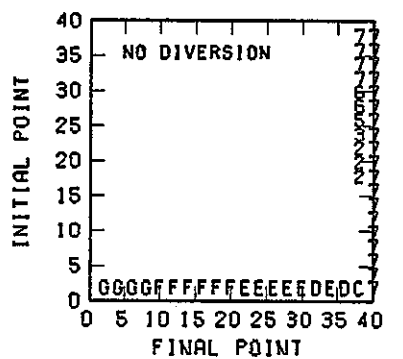
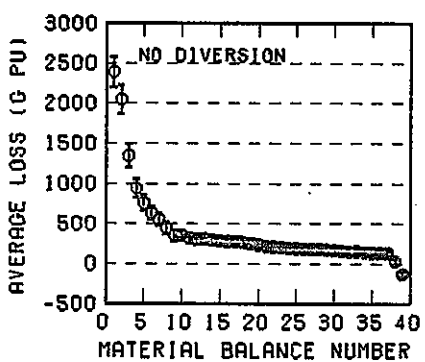
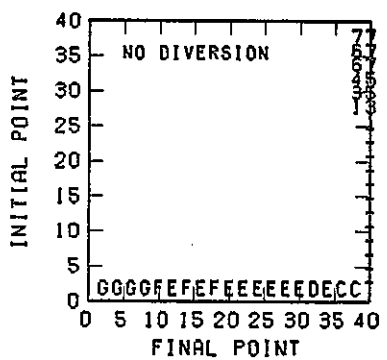
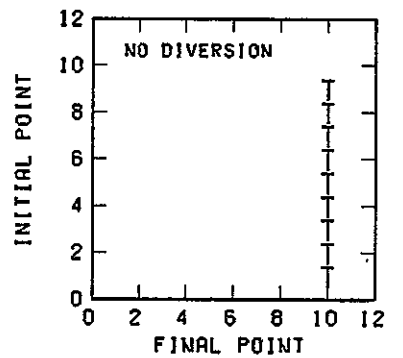
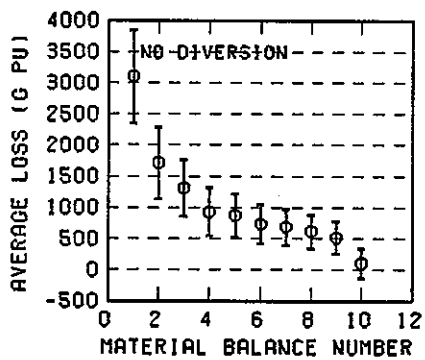
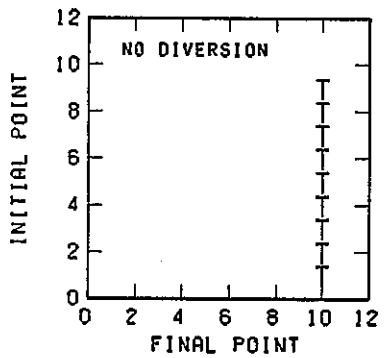
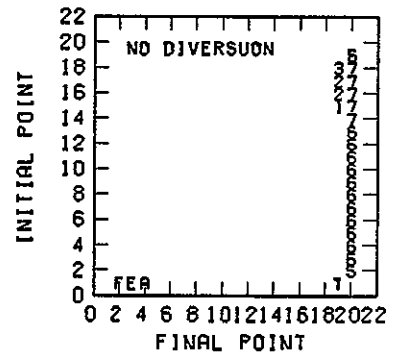
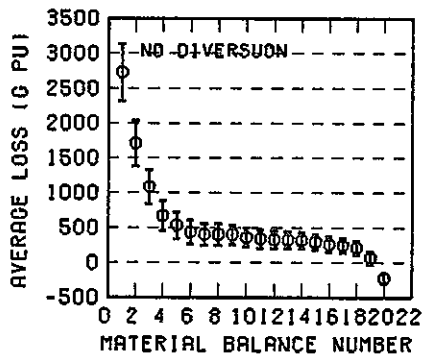
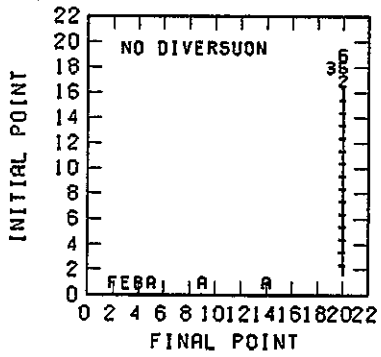
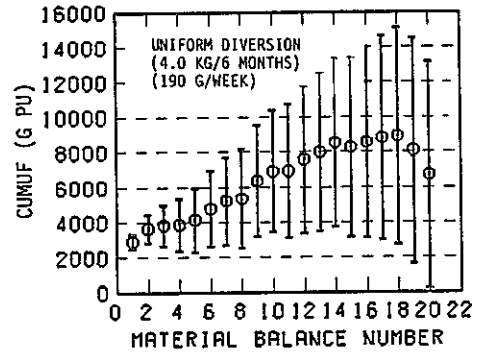
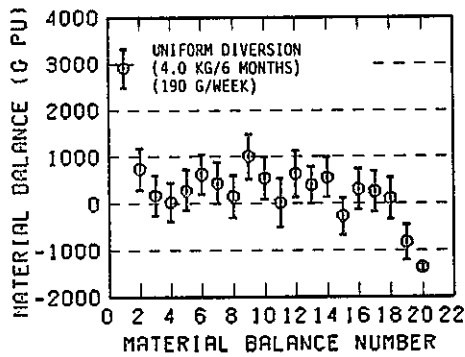

Fig. 5.13 CUMUF and uniform diversion tests for different n.r.t. material balance periods with S.S.1-5-1 (no diversion); Simulation period; 6 months.



7 Day-N.R.T.
Material Balance
Period



14 Day-N.R.T.
Material Balance
Period

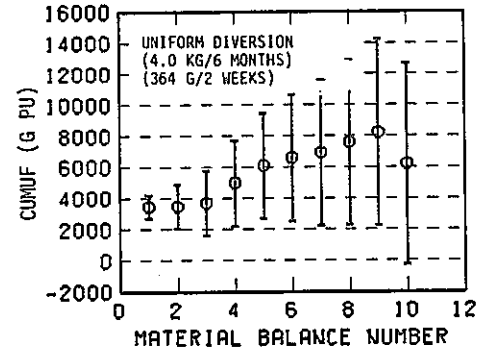
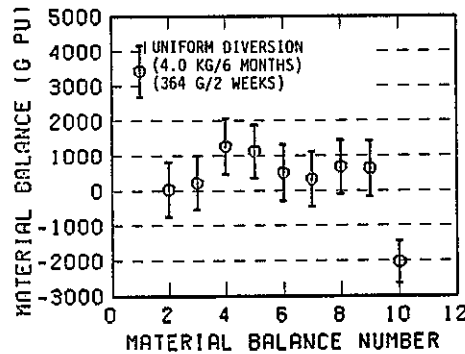

3 Day-N.R.T.
Material Balance
Period

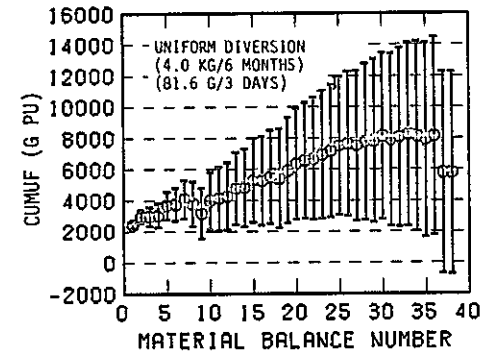
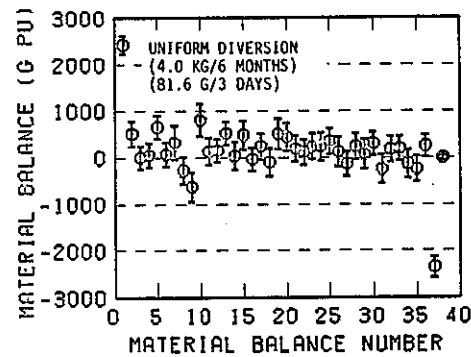
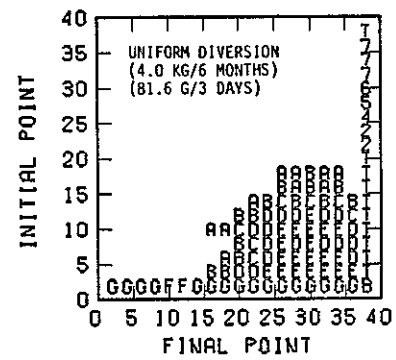
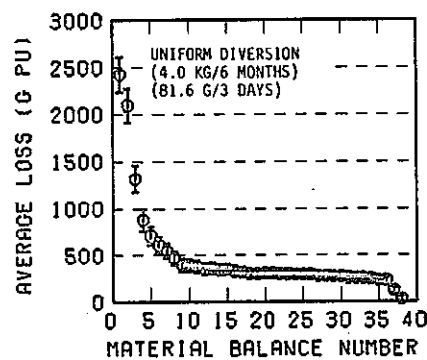
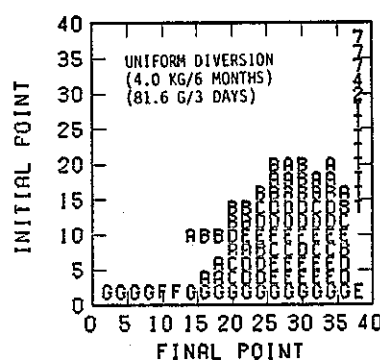
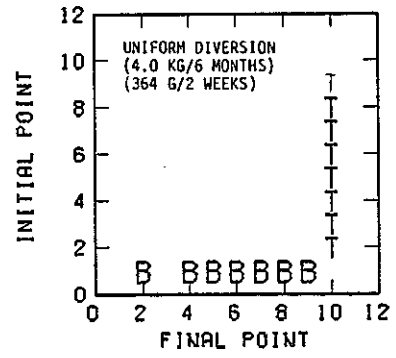
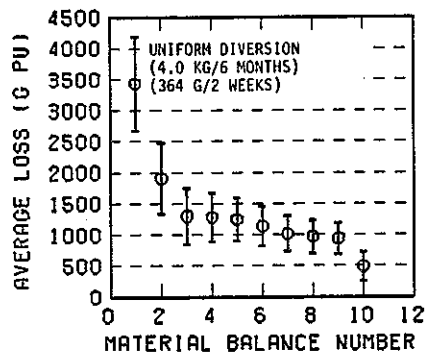
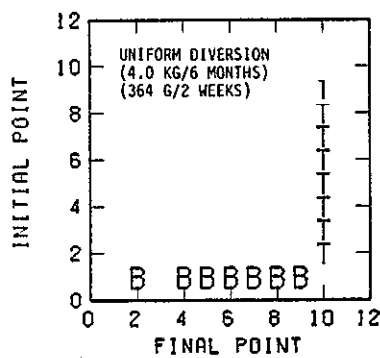
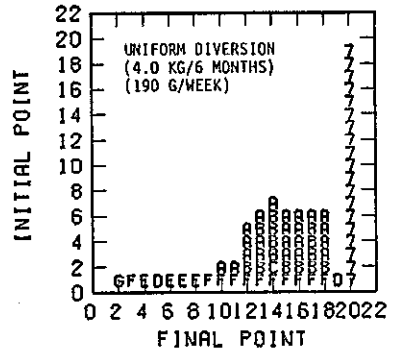
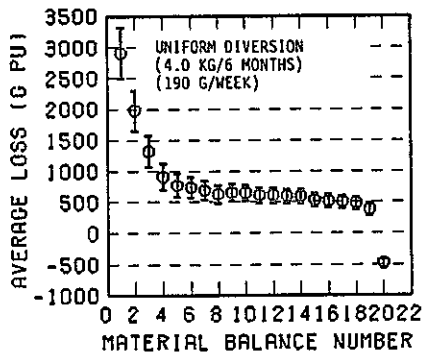
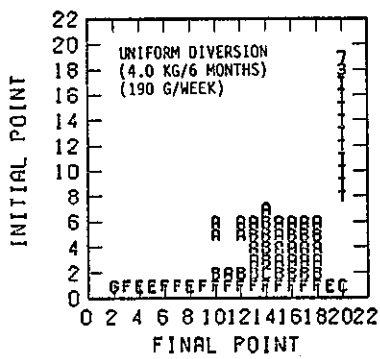
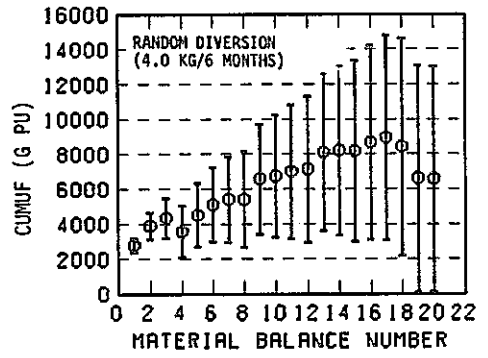
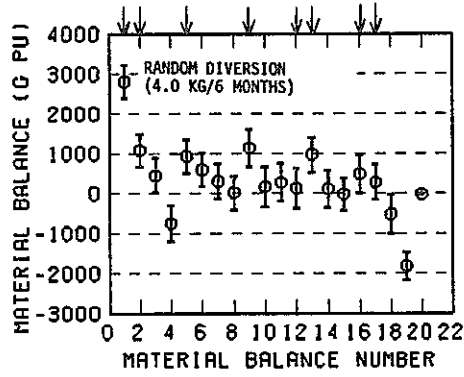

Fig. 5.14 CUMUF and uniform diversion tests for different n.r.t. material balance periods with S.S.1-5-1 (uniform diversion of 4 kgs Pu per 6 months).



7 Day-N.R.T.
Material Balance
Period



14 Day-N.R.T.
Material Balance
Period

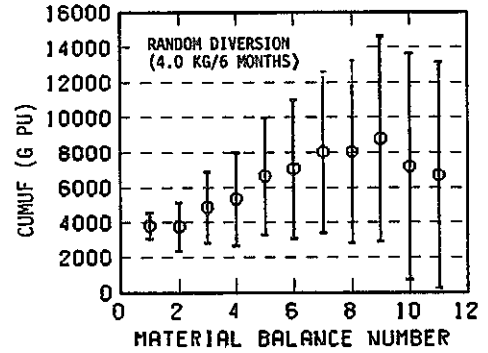
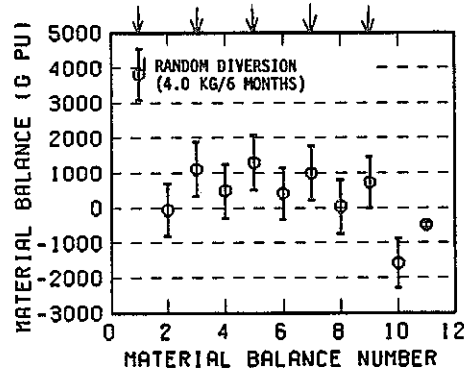

3 Day-N.R.T.
Material Balance
Period

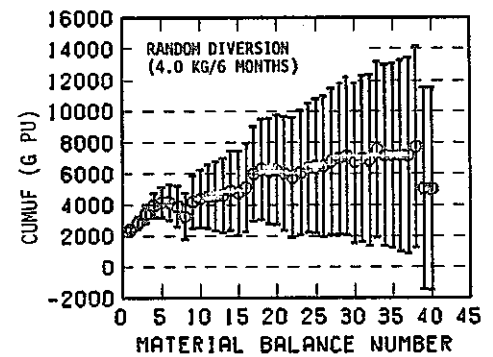
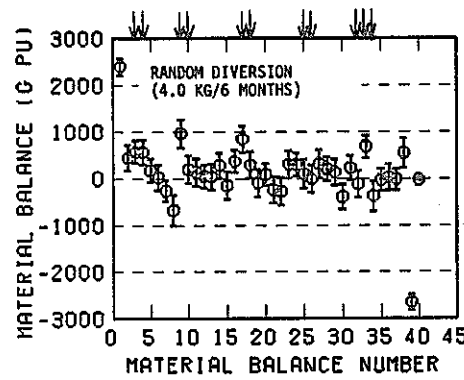
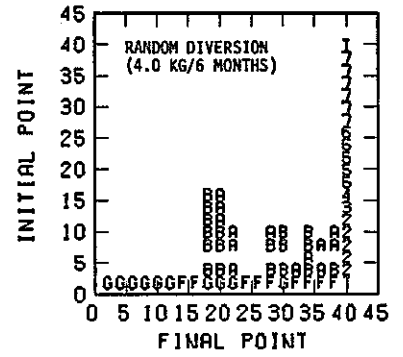
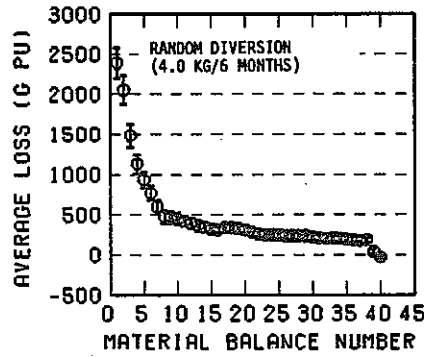
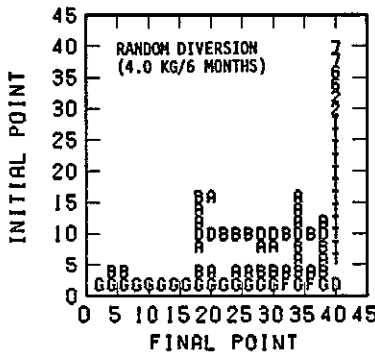
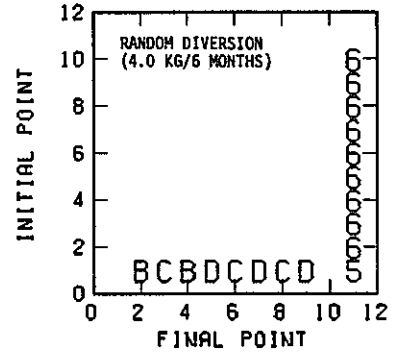
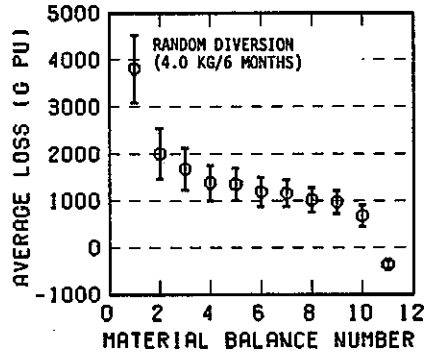
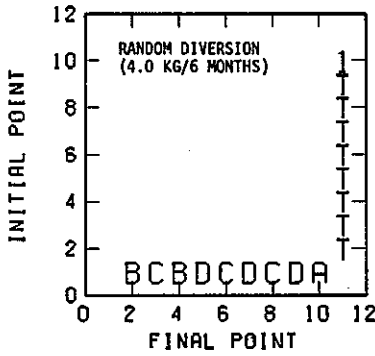
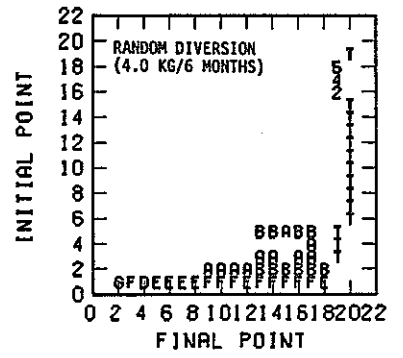
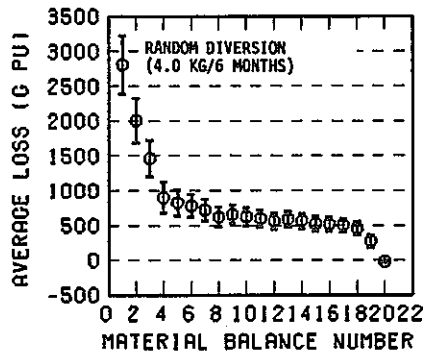
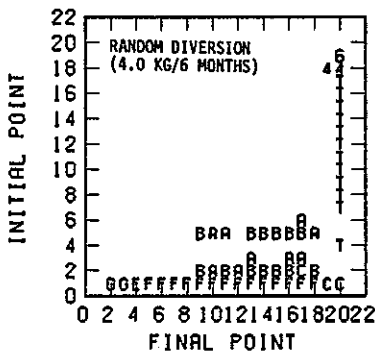
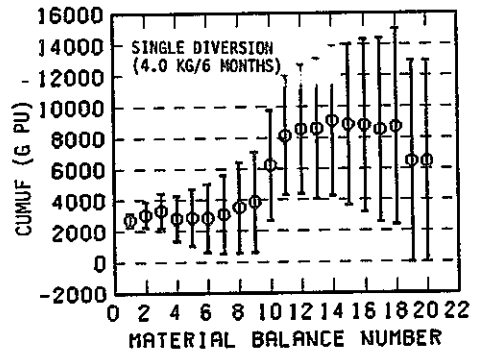
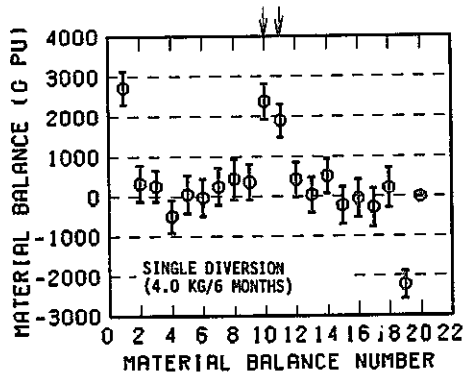

Fig. 5.15 CUMUF and uniform diversion tests for different n.r.t. material balance periods with S.S.1-5-1 (random diversion (ψ) of 4 kgs Pu per 6 months).



7 Day-N.R.T.
Material Balance
Period



14 Day-N.R.T.
Material Balance
Period

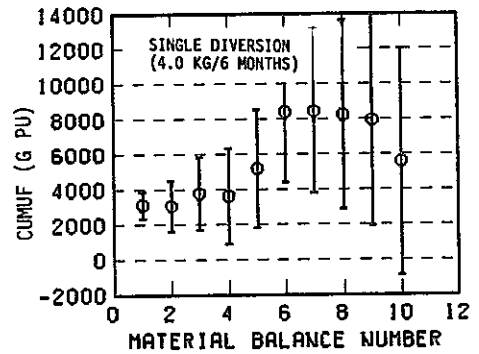
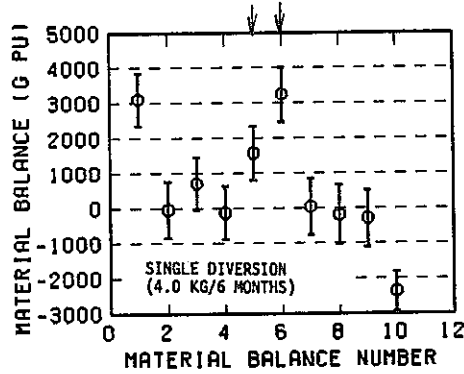

3 Day-N.R.T.
Material Balance
Period

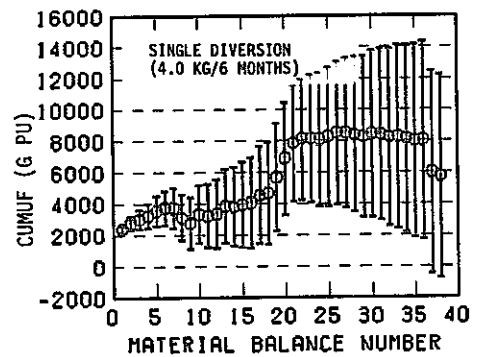
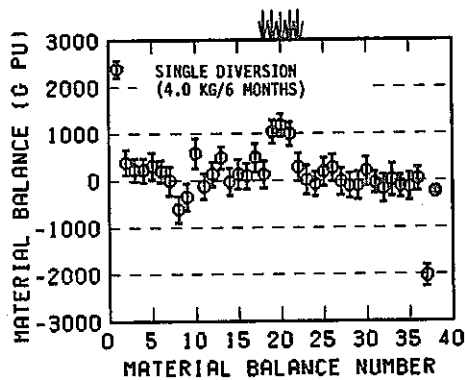
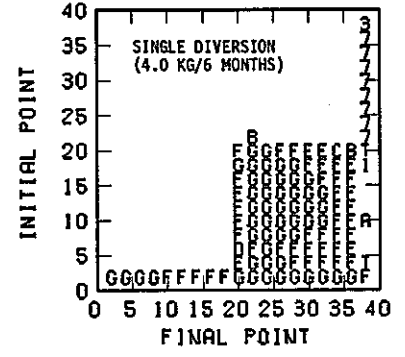
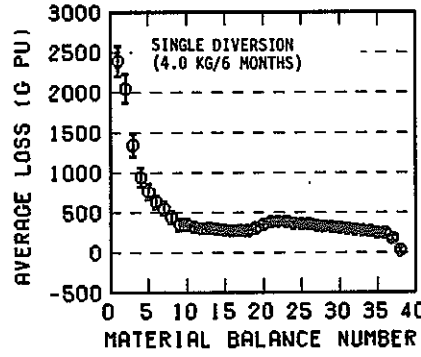
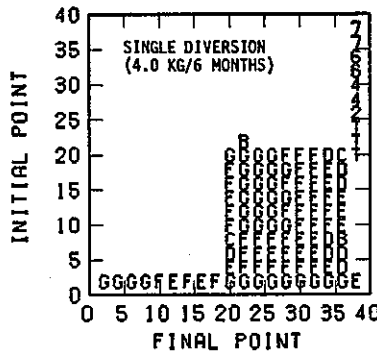
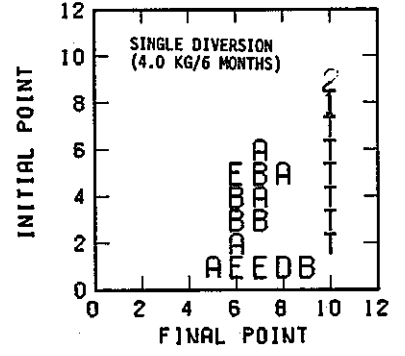
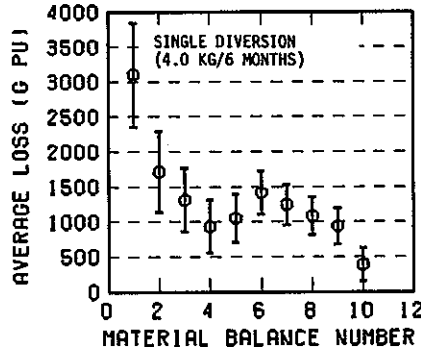
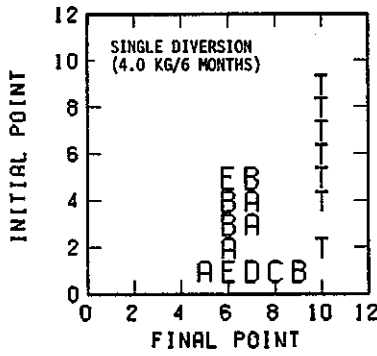
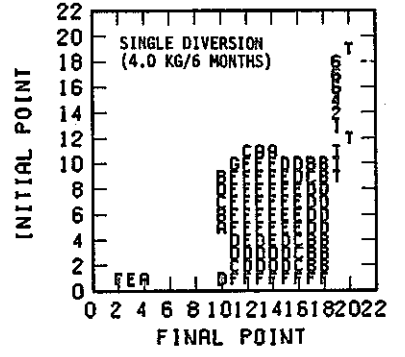
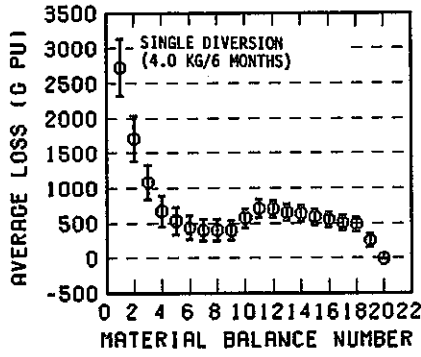
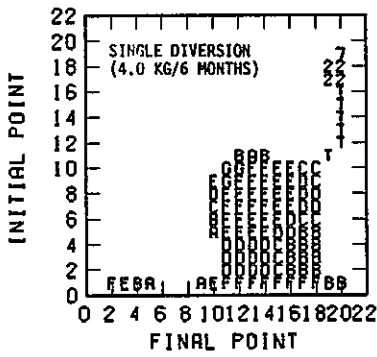
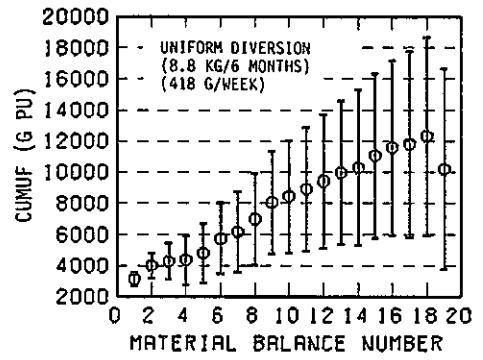
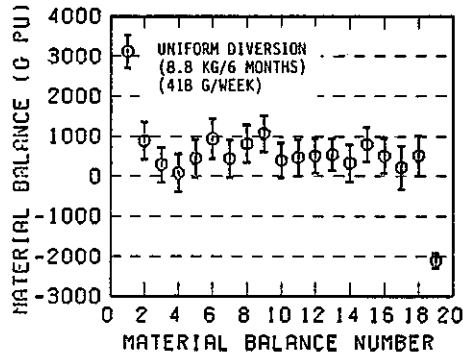

Fig. 5.16 CUMUF and uniform diversion tests for different n.r.t. material balance periods with S.S.1-5-1 (single diversion (↓) of 4.0 kgs Pu per 6 months).



7 Day-N.R.T.
Material Balance
Period



14 Day-N.R.T.
Material Balance
Period

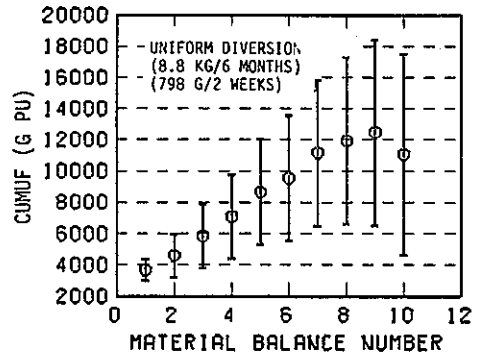
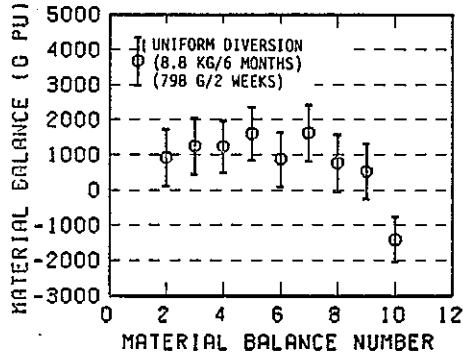

3 Day-N.R.T.
Material Balance
Period

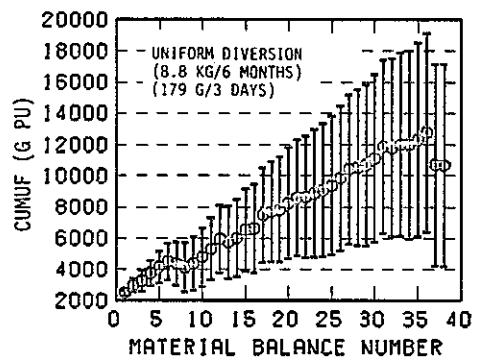
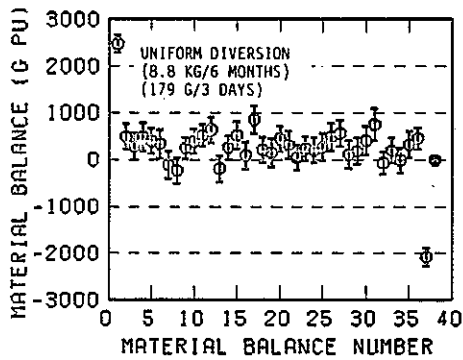
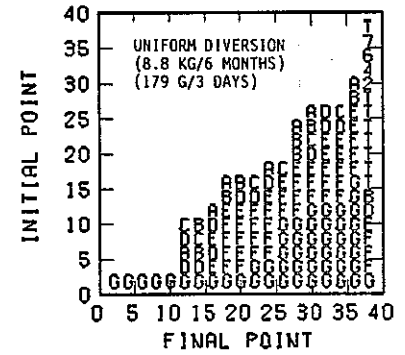
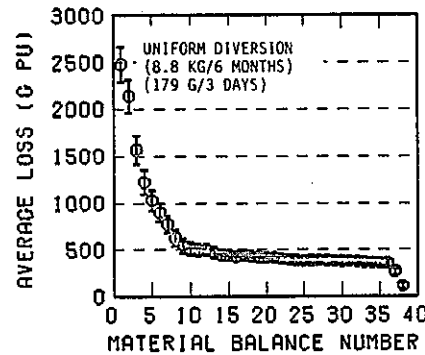
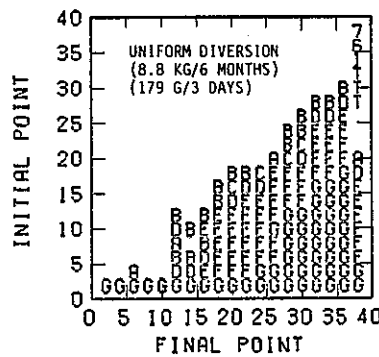
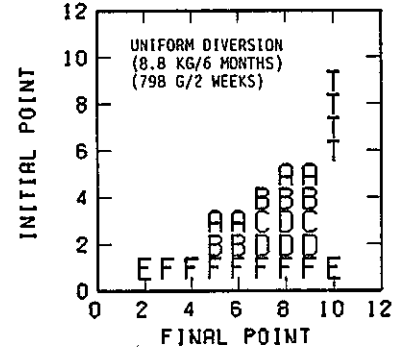
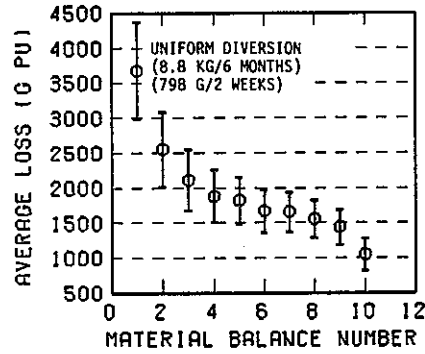
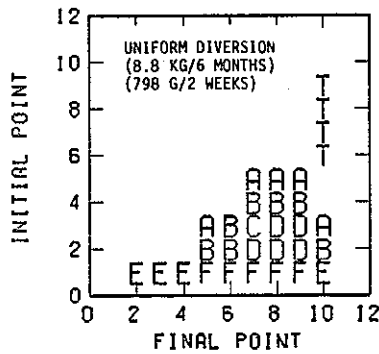
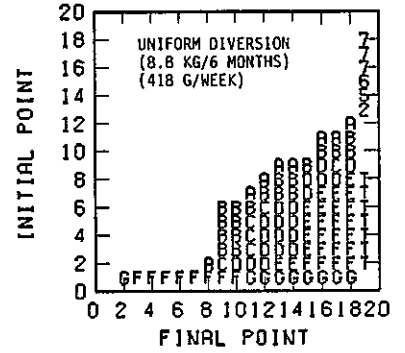
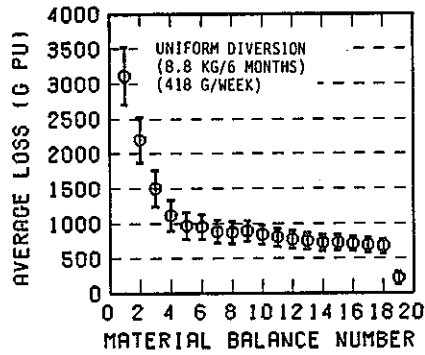
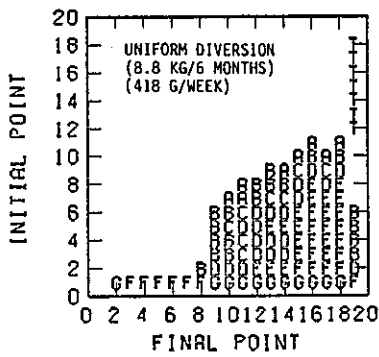
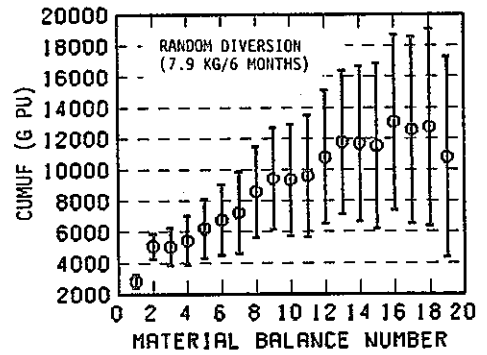
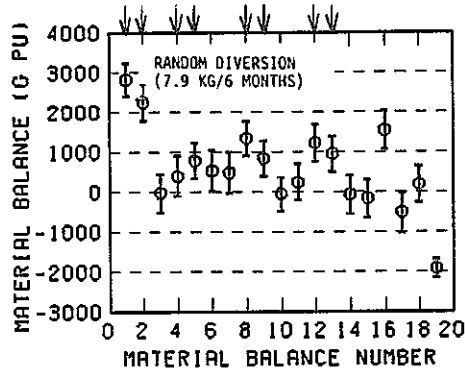

Fig. 5.17 CUMUF and uniform diversion tests for different n.r.t. material balance periods with S.S.1-5-1 (uniform diversion of 8.8 kgs Pu per 6 months).



7 Day-N.R.T.
Material Balance
Period



14 Day-N.R.T.
Material Balance
Period

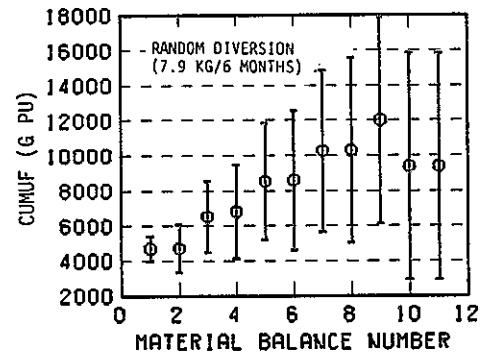
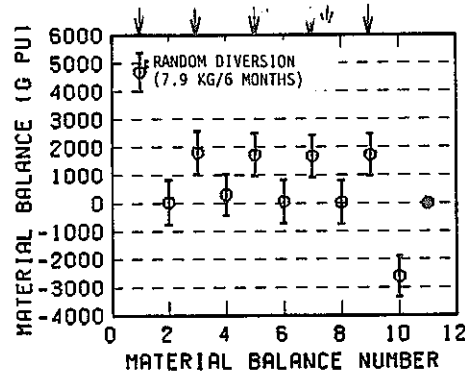

3 Day-N.R.T.
Material Balance
Period

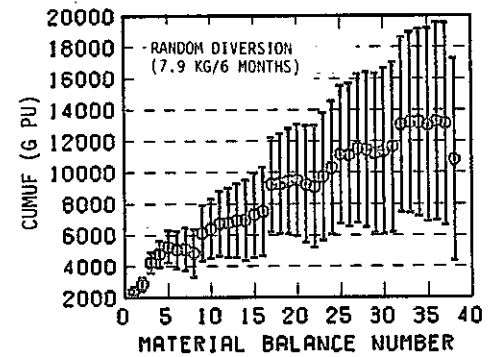
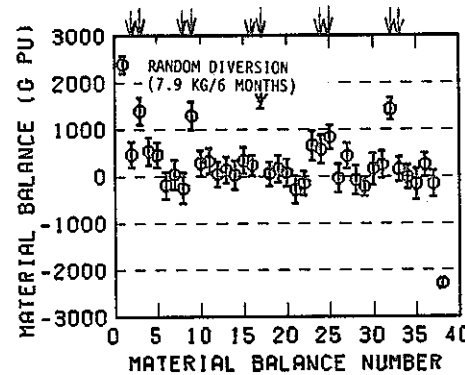
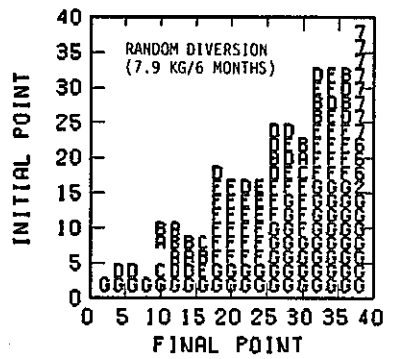
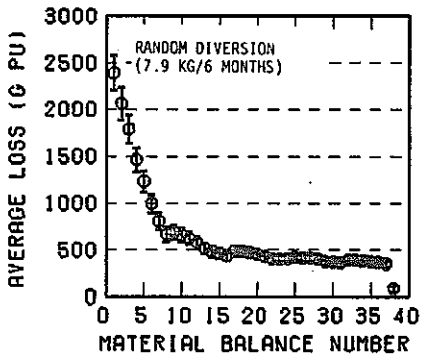
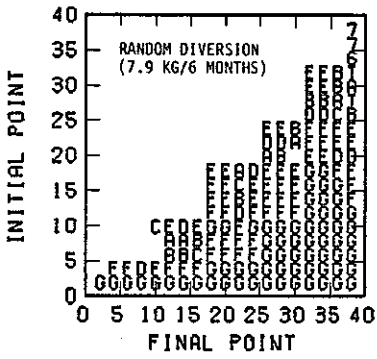
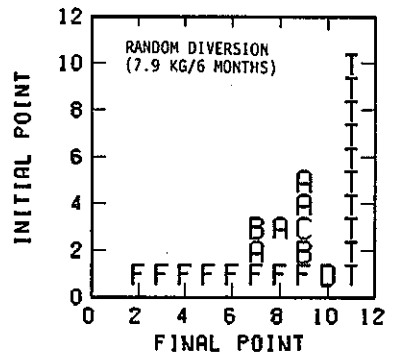
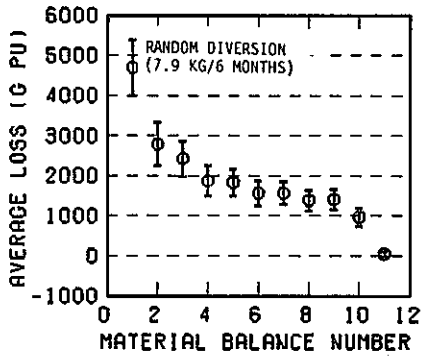
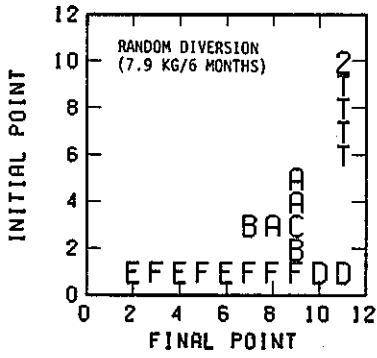
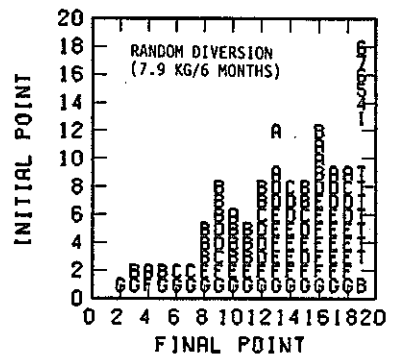
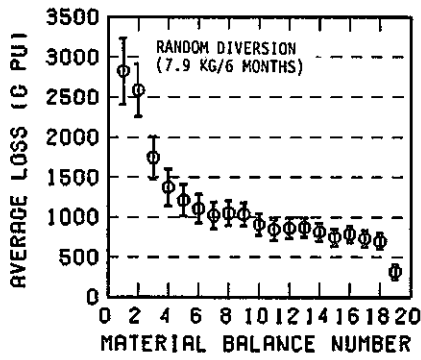
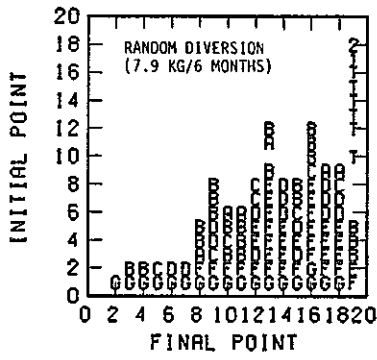
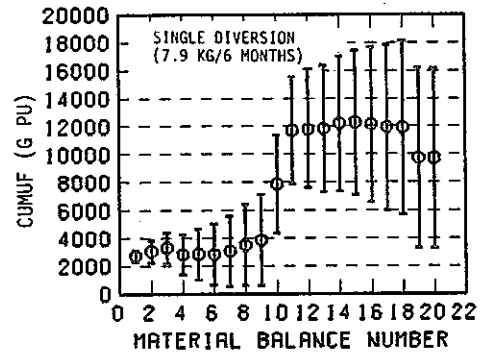
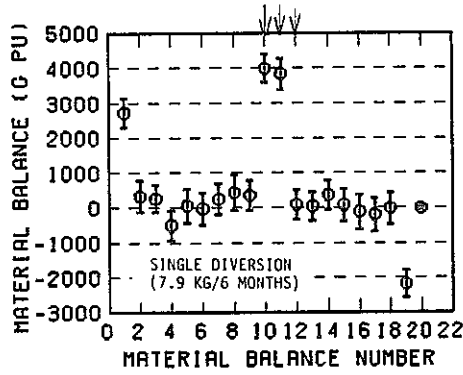

Fig. 5.18 CUMUF and uniform diversion tests for different n.r.t. material balance periods with S.S.1-5-1 (random diversion (ψ) 7.9 kgs Pu per 6 months).



7 Day-N.R.T.
Material Balance
Period



14 Day-N.R.T.
Material Balance
Period

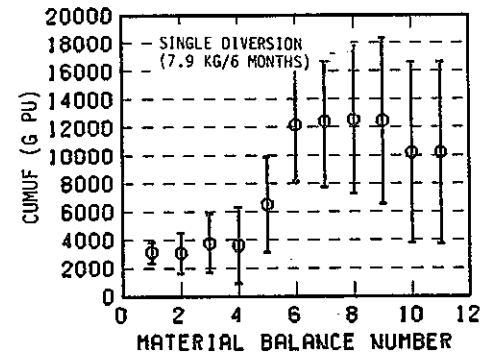
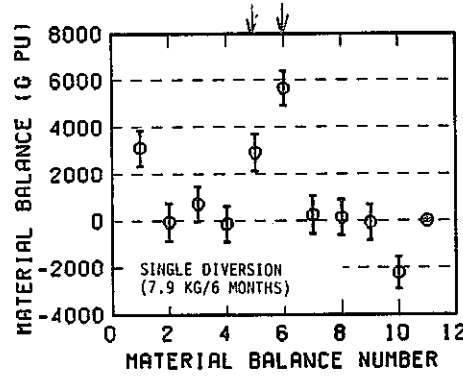

3 Day-N.R.T.
Material Balance
Period

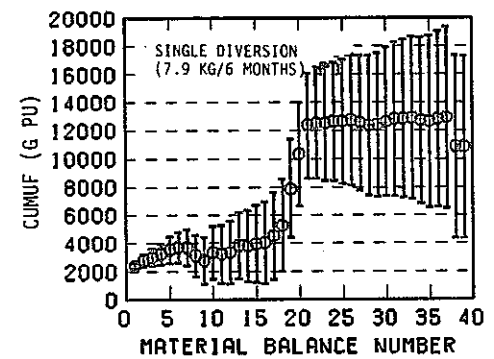
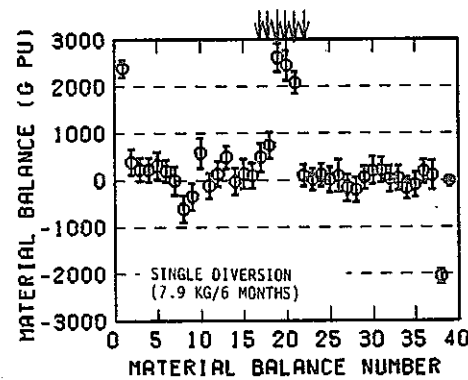
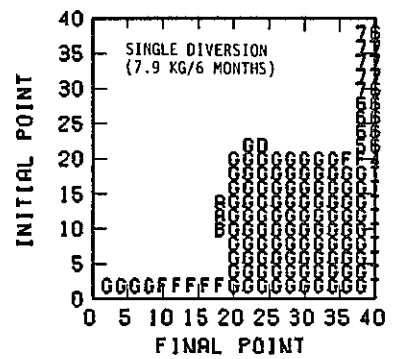
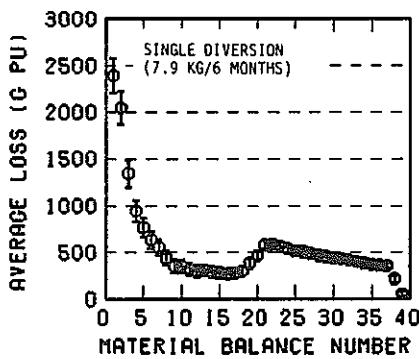
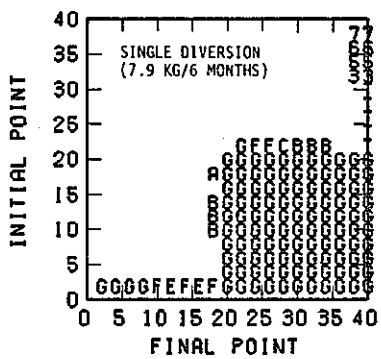
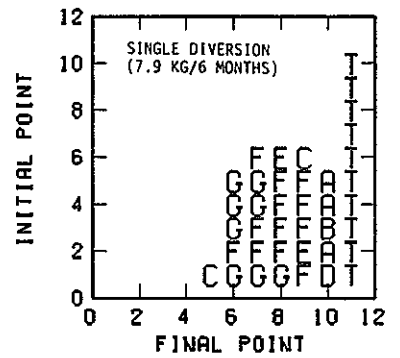
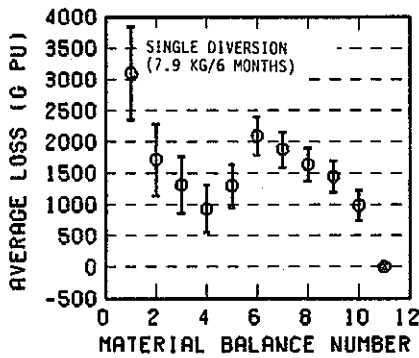
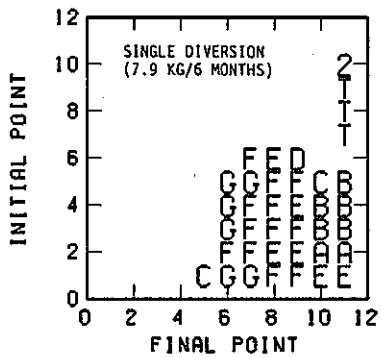
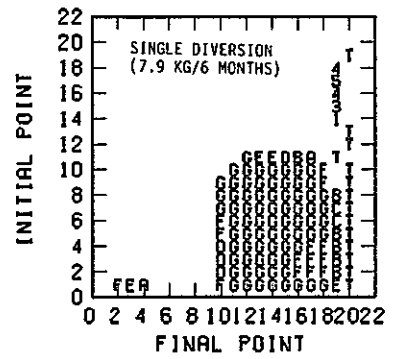
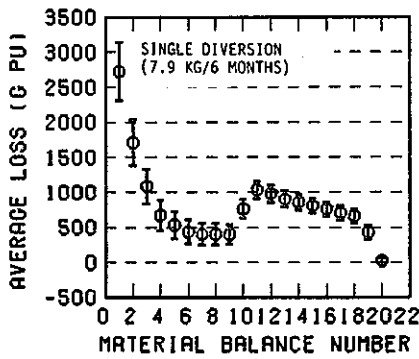
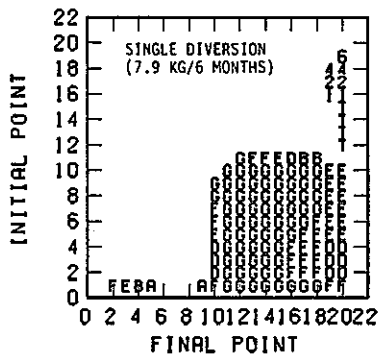
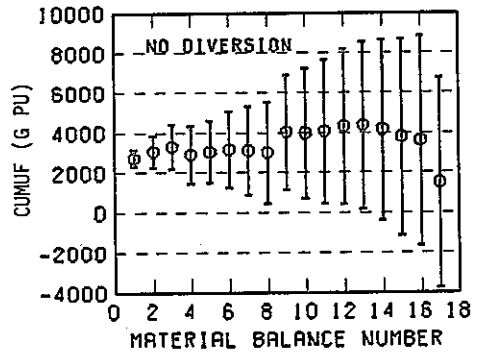
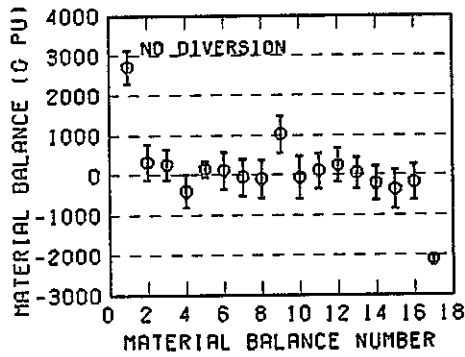

Fig. 5.19 CUMUF and uniform diversion tests for different n.r.t. material balance periods with S.S.1-5-1 (single diversion (∇) of 7.0 kgs Pu per 6 months).



7 Day-N.R.T.
Material Balance
Period



14 Day-N.R.T.
Material Balance
Period

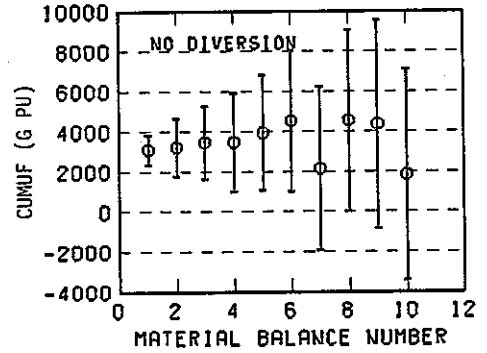
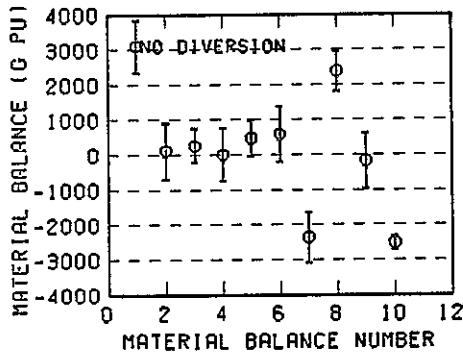

3 Day-N.R.T.
Material Balance
Period

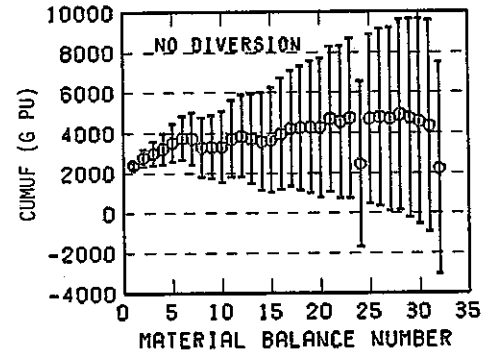
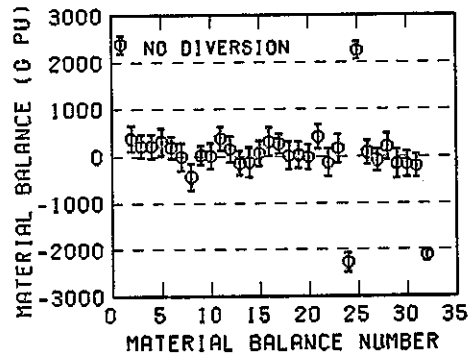
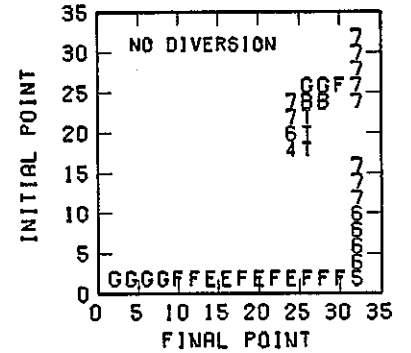
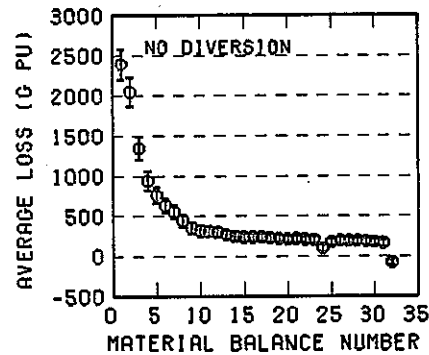
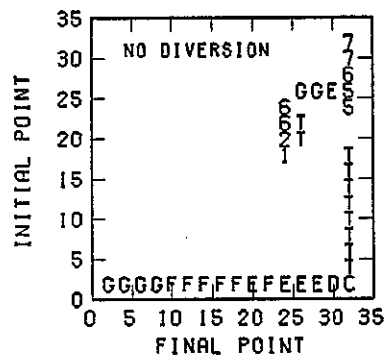
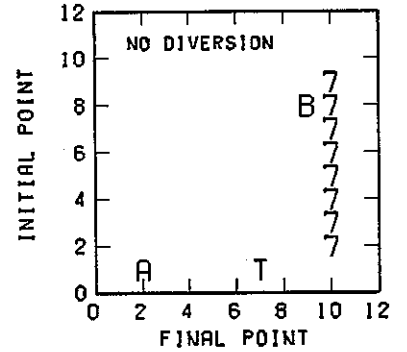
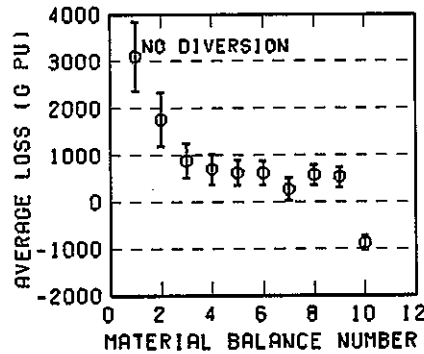
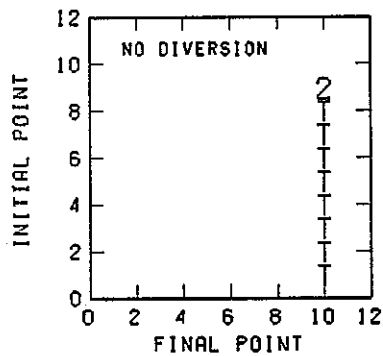
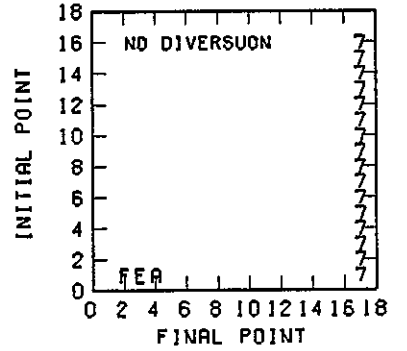
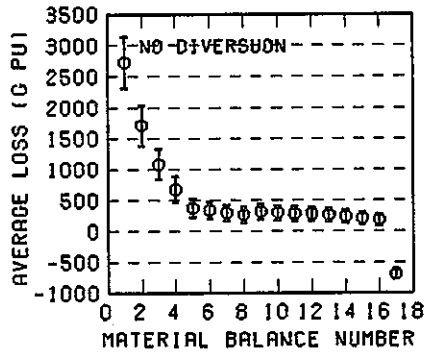
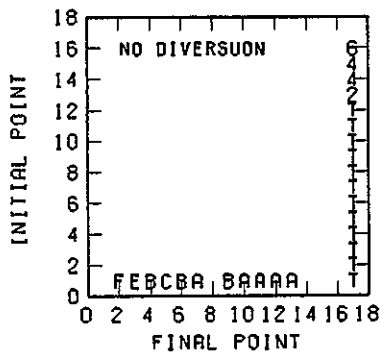
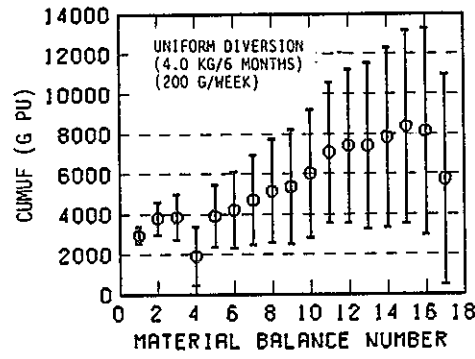
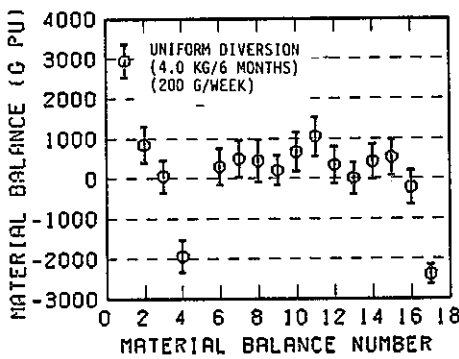

Fig. 5.20 CUMUF and uniform diversion tests for different n.r.t. material balance periods with S.S.1-8 (no diversion); Simulation period; 6 months.



7 Day-N.R.T.
Material Balance
Period



14 Day-N.R.T.
Material Balance
Period

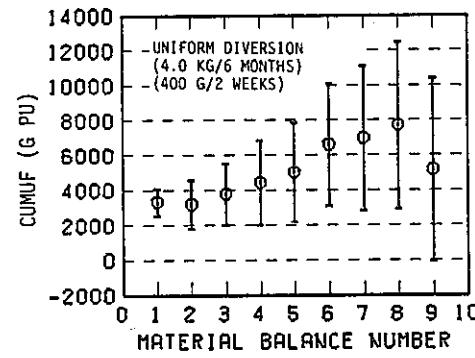
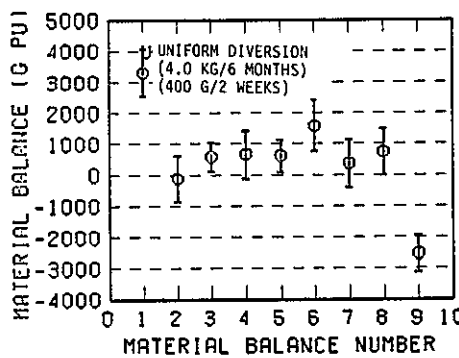

3 Day-N.R.T.
Material Balance
Period

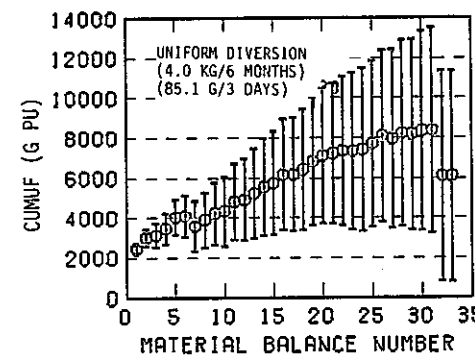
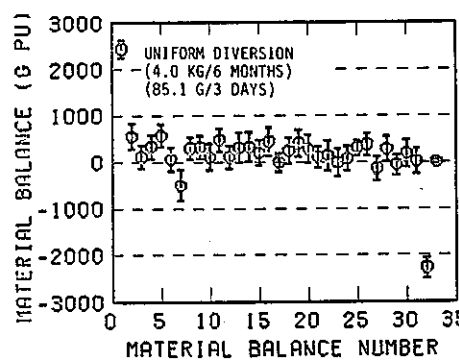
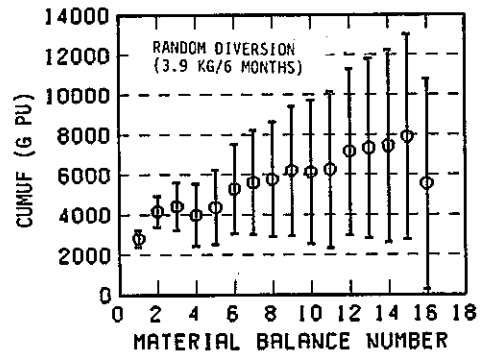
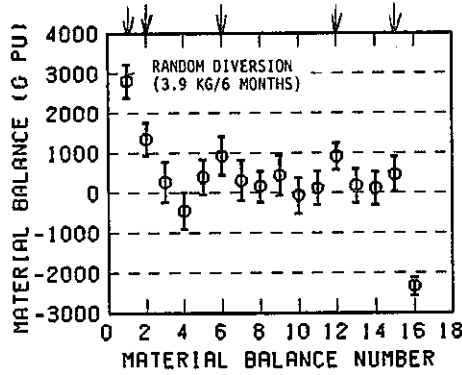
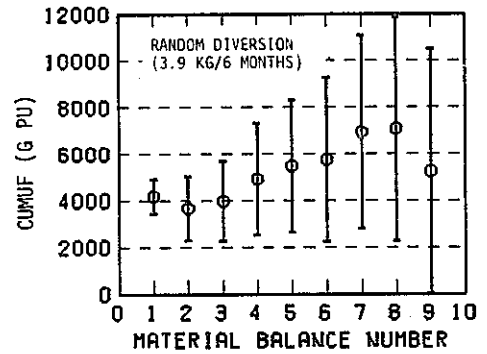
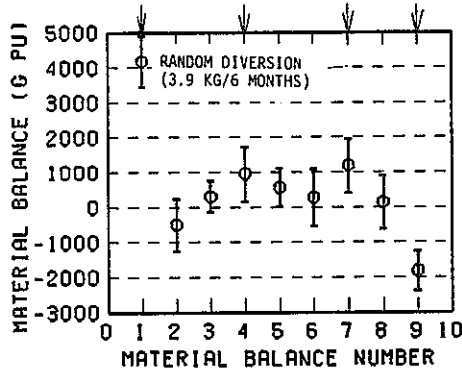

Fig. 5.21 CUMUF and uniform diversion tests for different n.r.t. material balance periods with S.S.1-8 (uniform diversion of 4 kgs Pu per 6 months).

7 Day-N.R.T.
Material Balance
Period



14 Day-N.R.T.
Material Balance
Period



3 Day-N.R.T.
Material Balance
Period

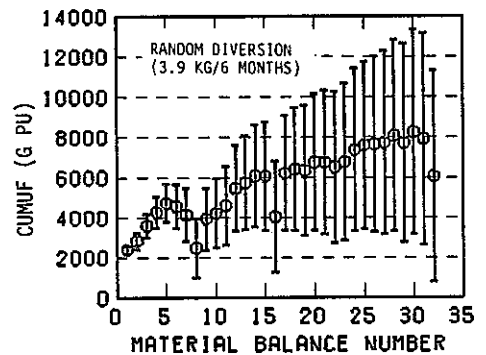
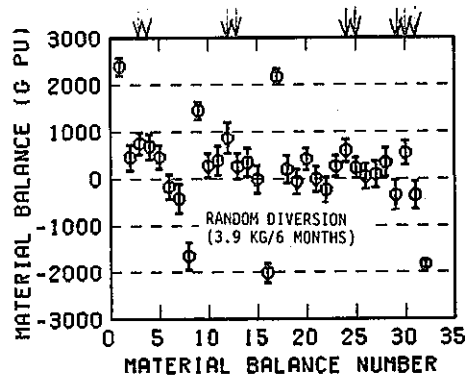
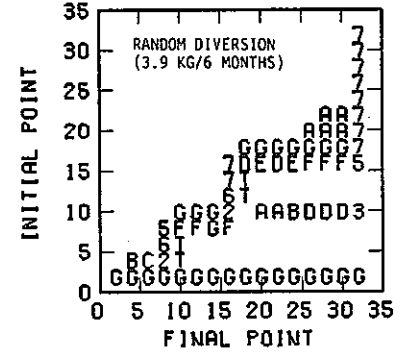
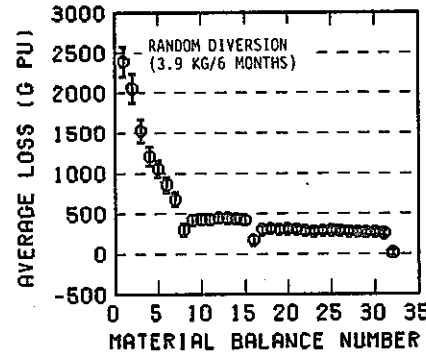
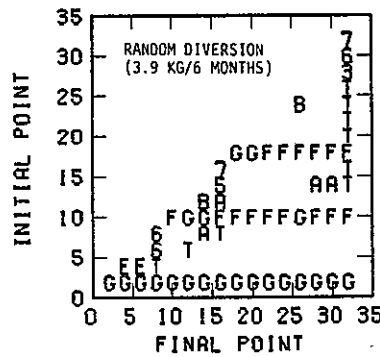
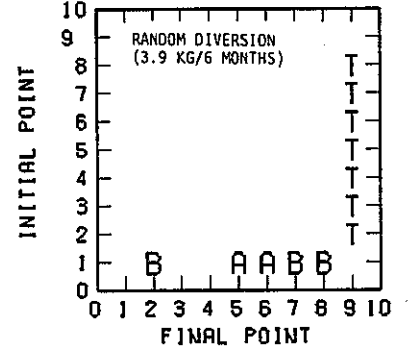
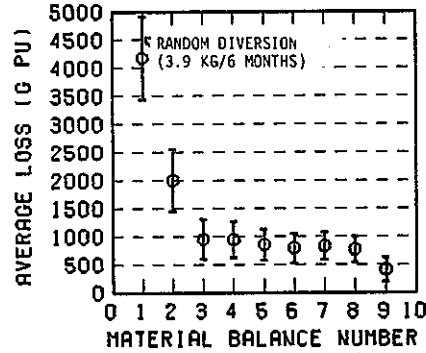
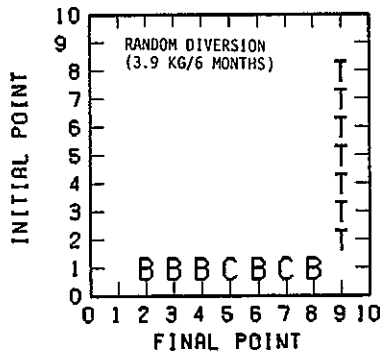
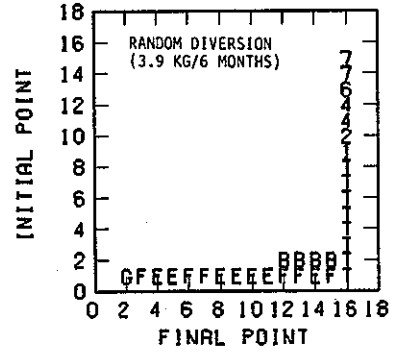
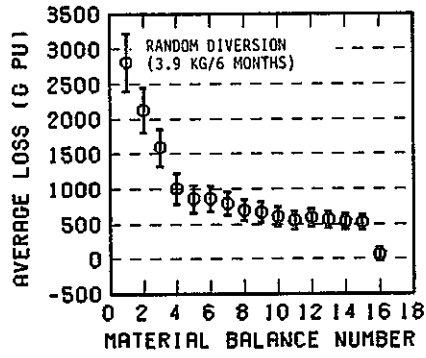
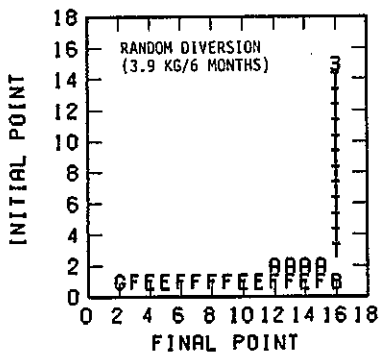
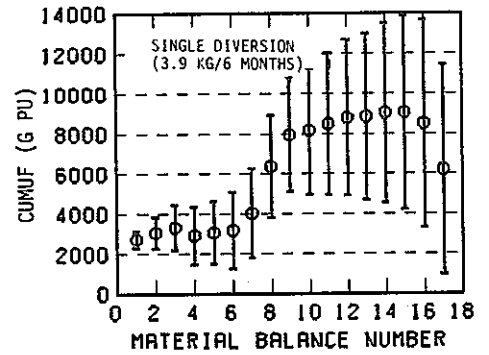
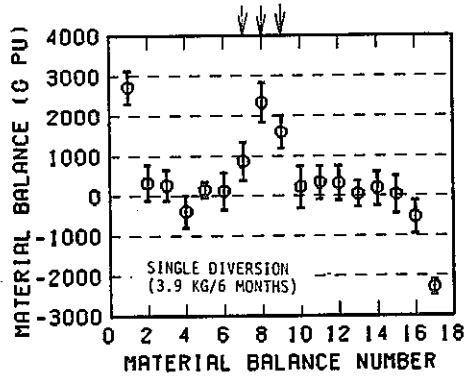

Fig. 5.22 CUMUF and uniform diversion tests for different n.r.t. material balance periods with S.S.1-8 (uniform diversion (\downarrow) of 3.9 kgs Pu per 6 months).



7 Day-N.R.T.
Material Balance
Period



14 Day-N.R.T.
Material Balance
Period

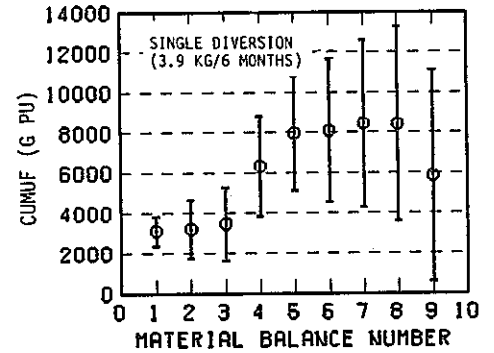
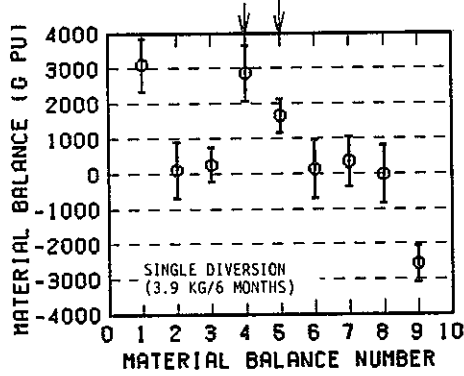

3 Day-N.R.T.
Material Balance
Period

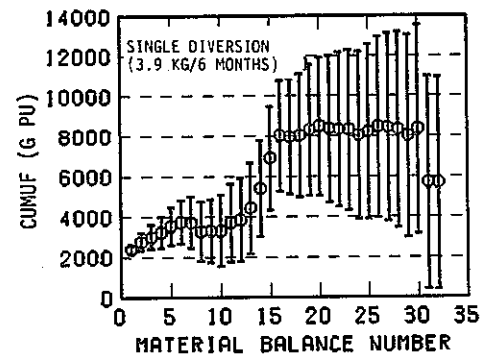
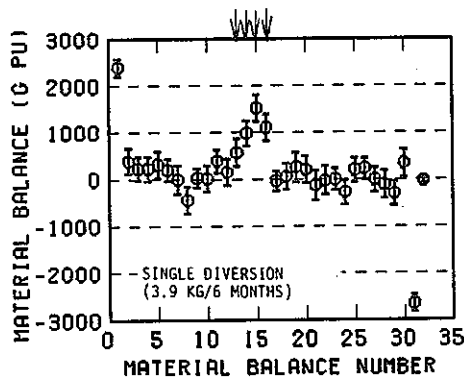
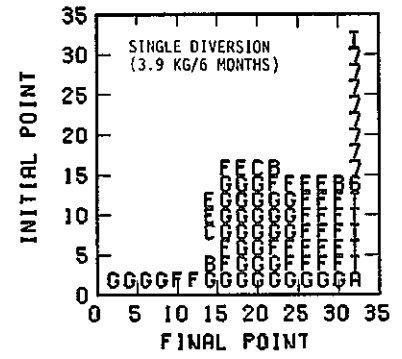
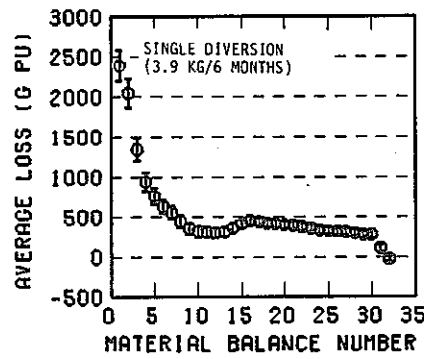
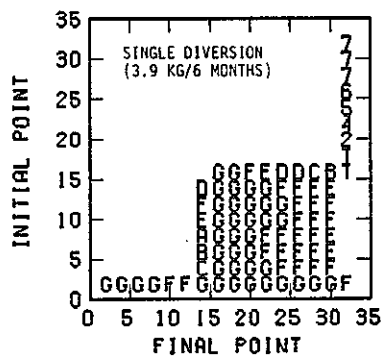
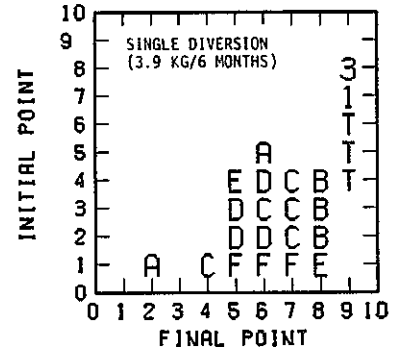
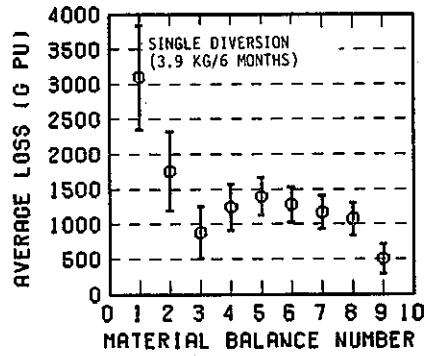
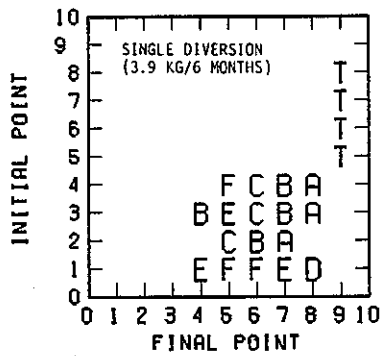
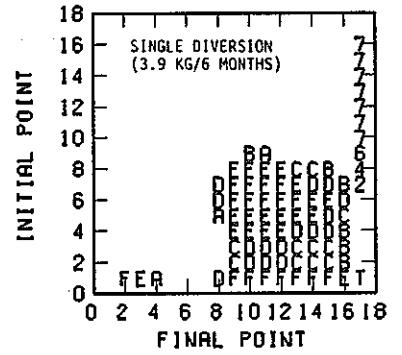
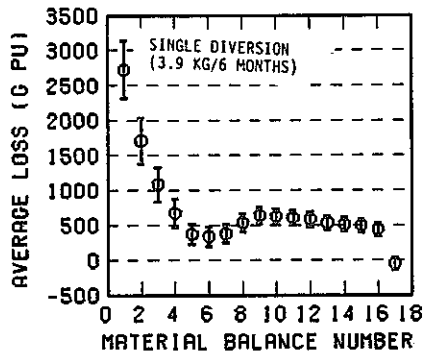
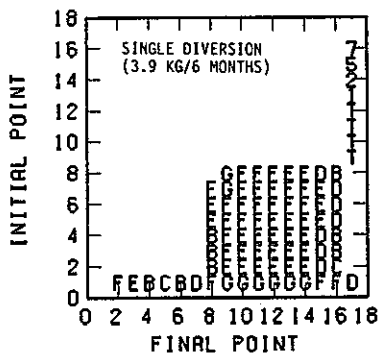
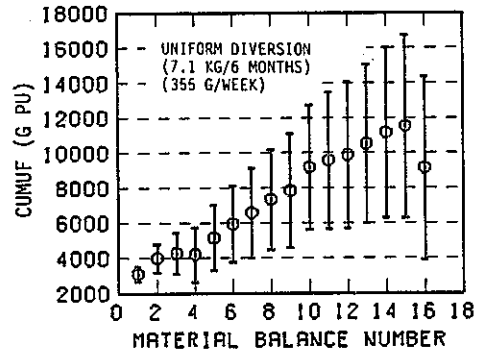
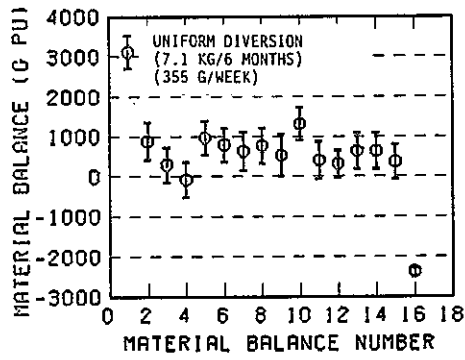

Fig. 5.23 CUMUF and uniform diversion tests for different n.r.t. material balance periods with S.S.1-8 (single diversion (ψ) of 3.9 kgs Pu per 6 months).



7 Day-N.R.T.
Material Balance
Period



14 Day-N.R.T.
Material Balance
Period

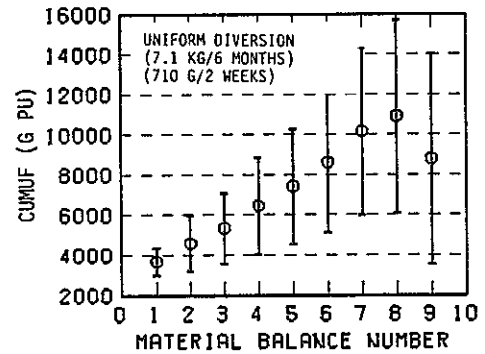
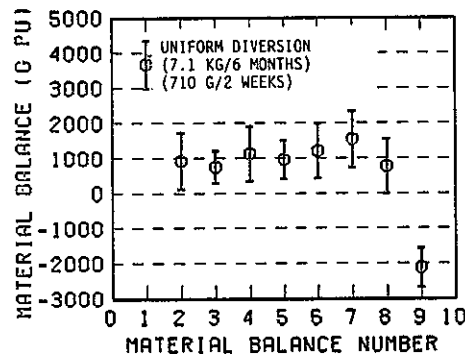

3 Day-N.R.T.
Material Balance
Period

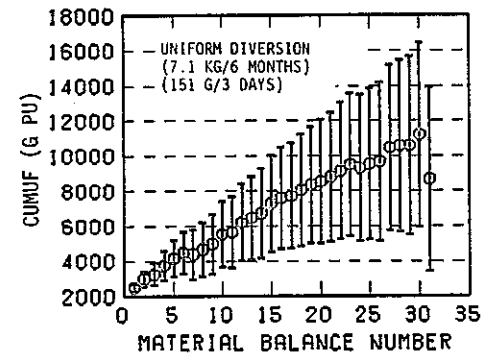
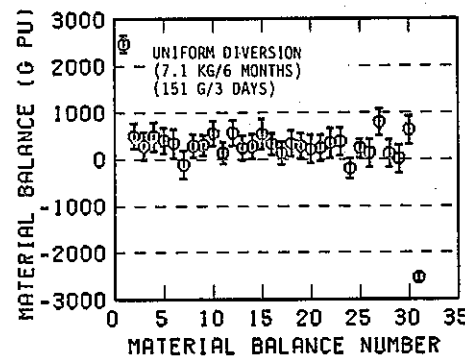
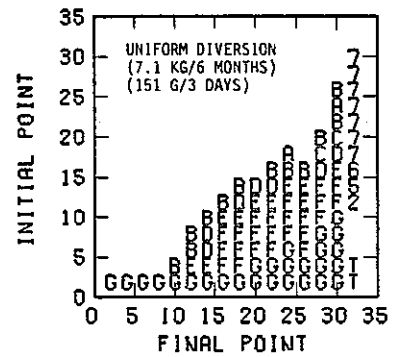
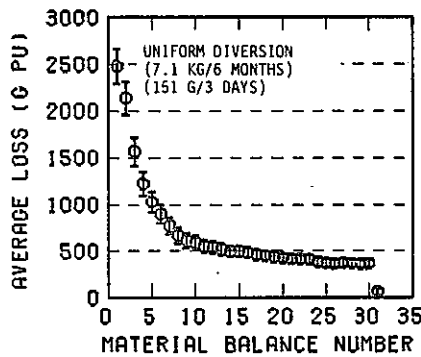
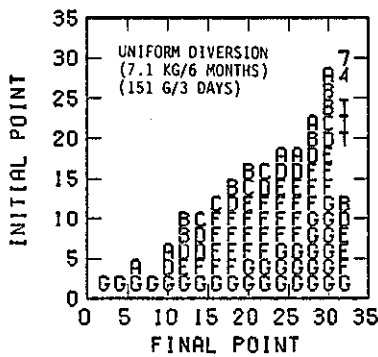
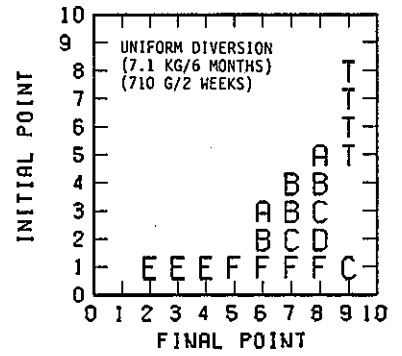
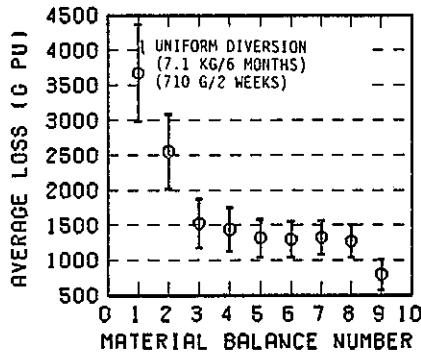
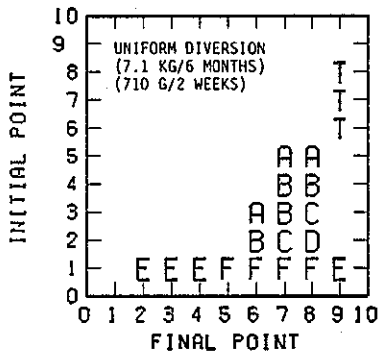
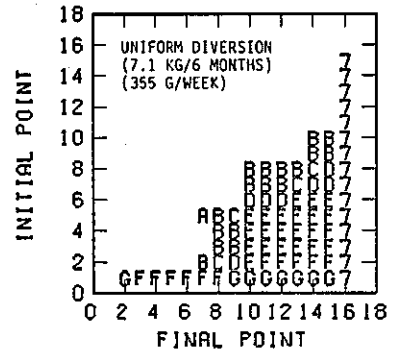
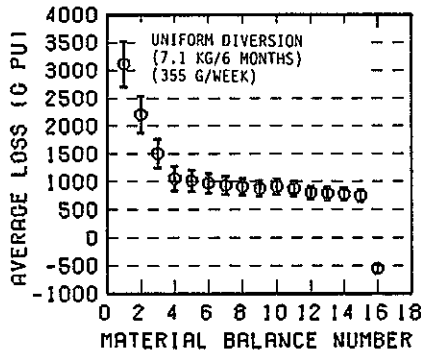
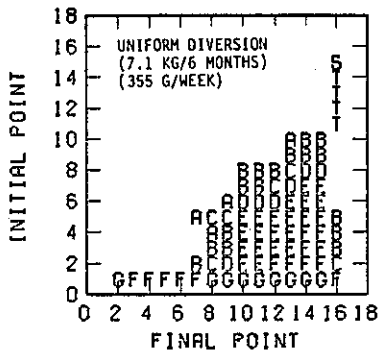
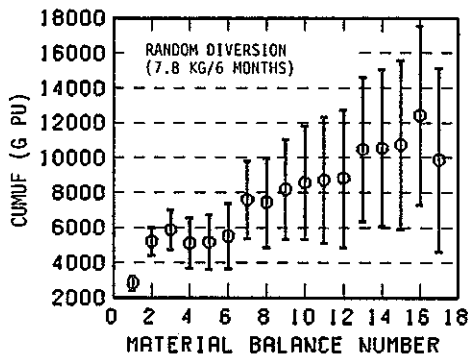
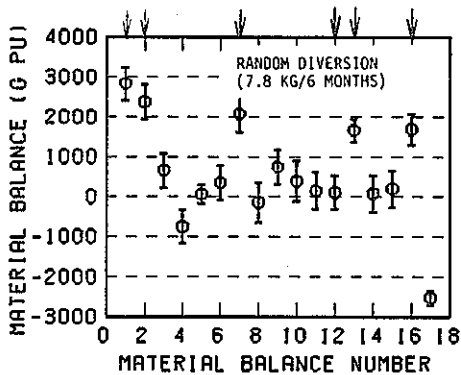

Fig. 5.24 CUMUF and uniform diversion tests for different n.r.t. material balance periods with S.S.1-8 (uniform diversion of 7.1 kgs Pu per 6 months).



7 Day-N.R.T.
Material Balance
Period



14 Day-N.R.T.
Material Balance
Period

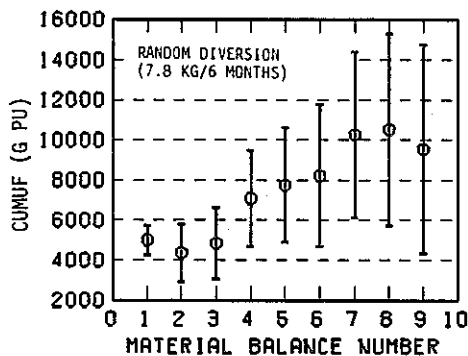
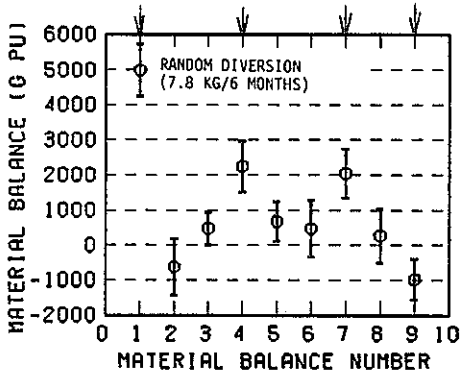

3 Day-N.R.T.
Material Balance
Period

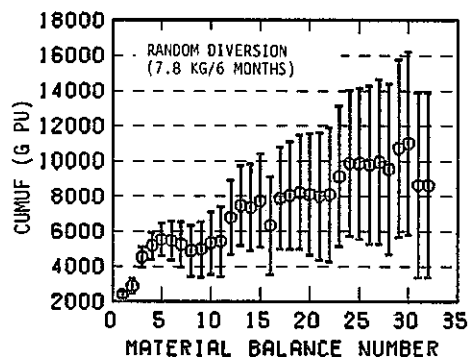
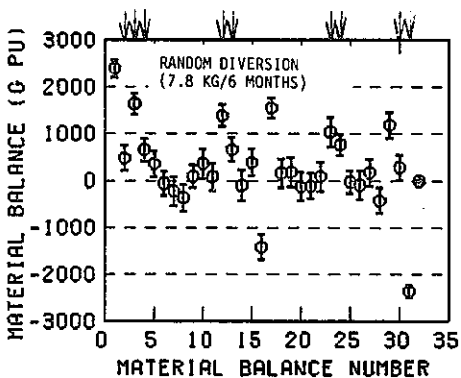
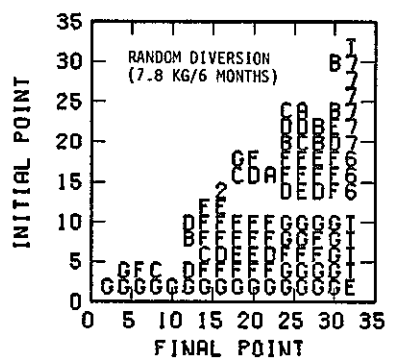
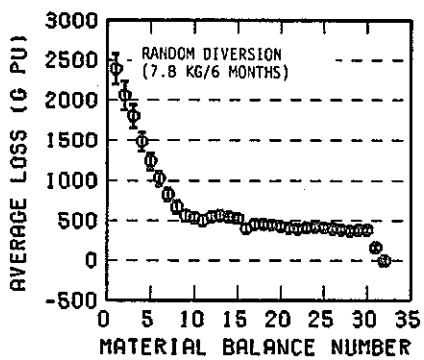
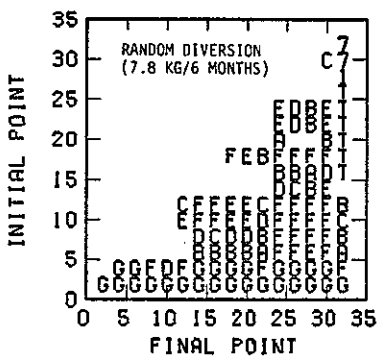
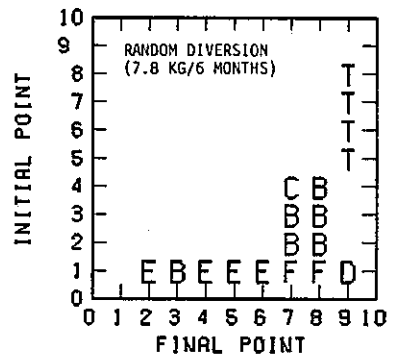
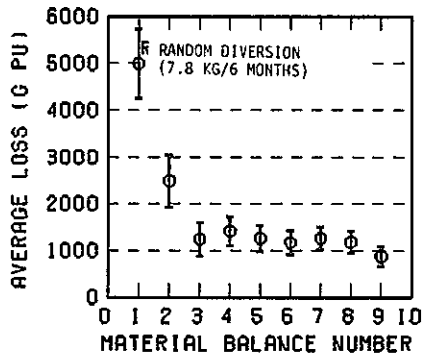
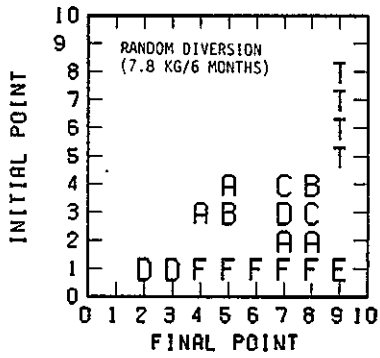
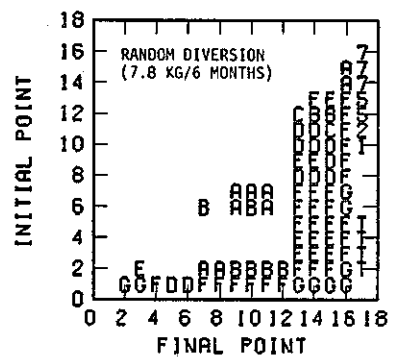
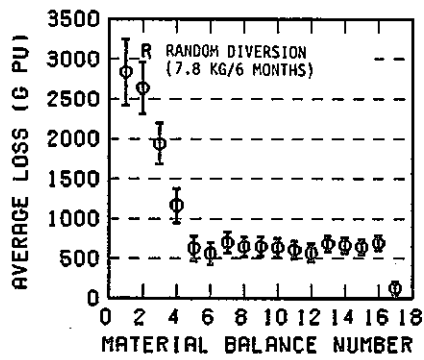
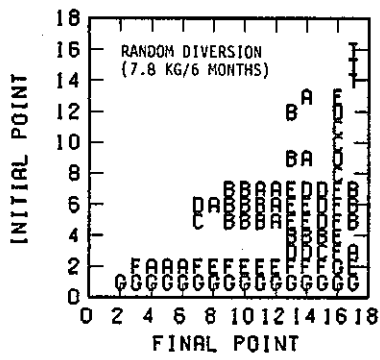
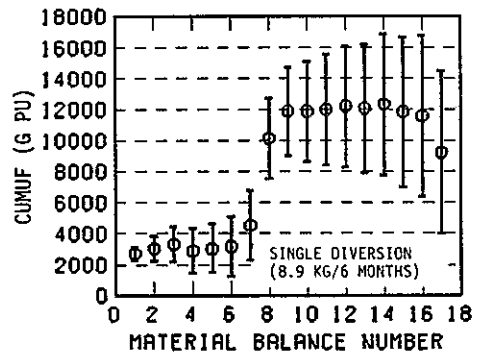
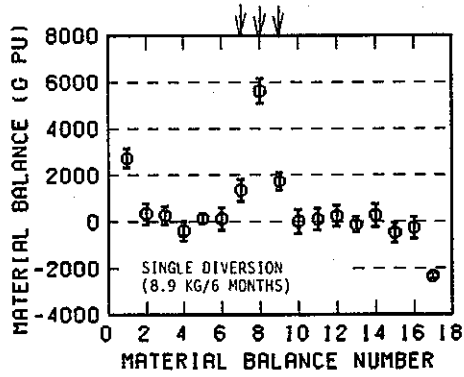

Fig. 5.25 CUMUF and uniform diversion tests for different n.r.t. material balance periods with S.S.1-8 (random diversion (↓) 7.8 kgs Pu per 6 months).



7 Day-N.R.T.
Material Balance
Period



14 Day-N.R.T.
Material Balance
Period

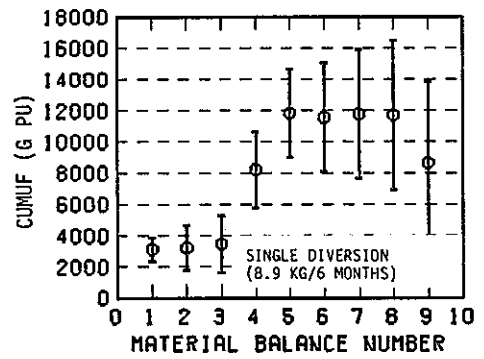
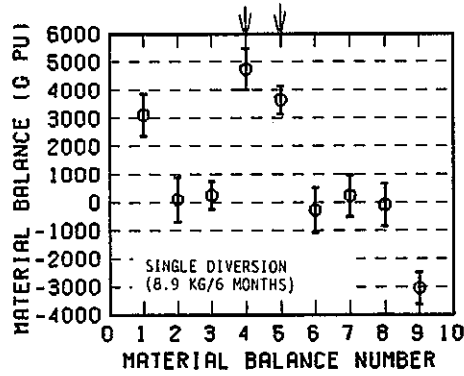

3 Day-N.R.T.
Material Balance
Period

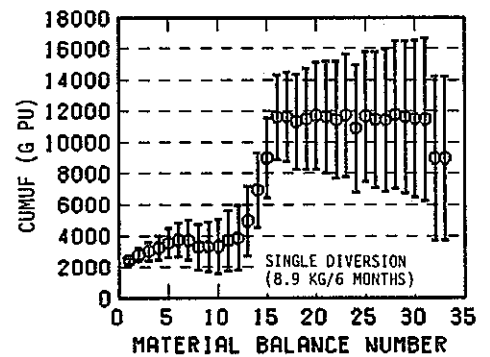
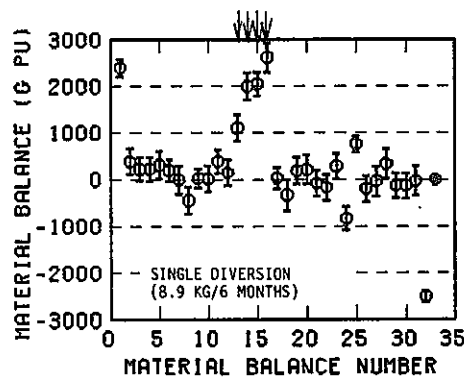
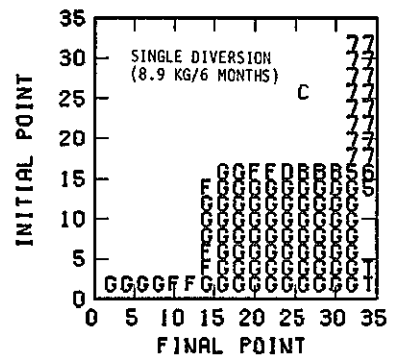
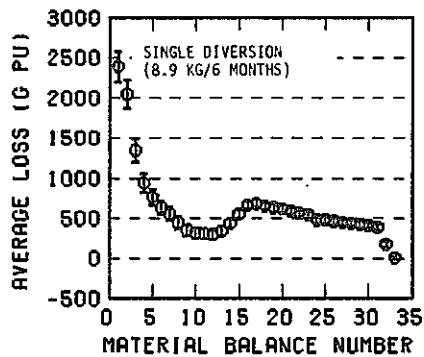
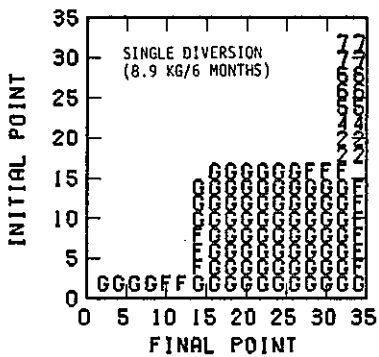
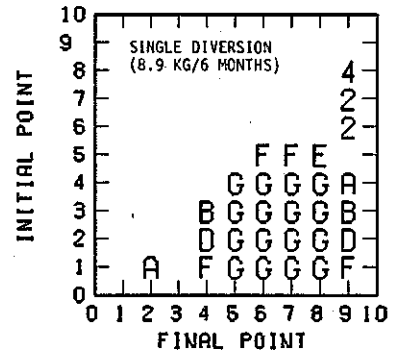
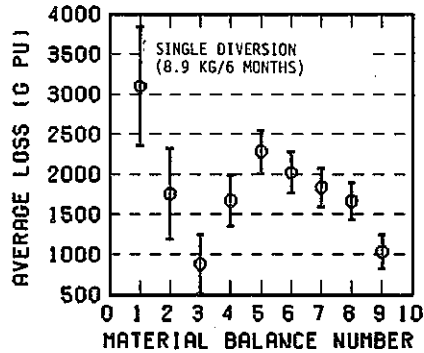
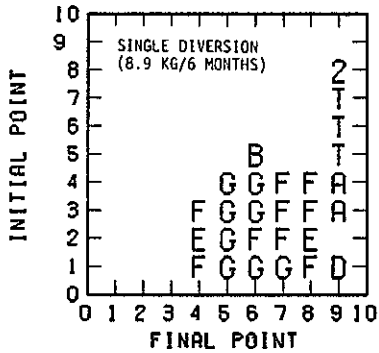
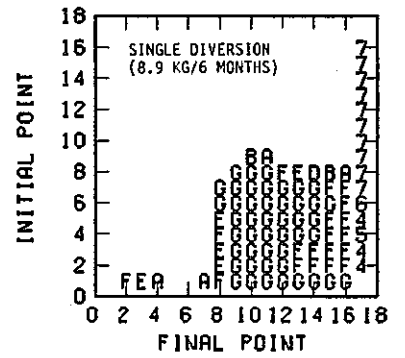
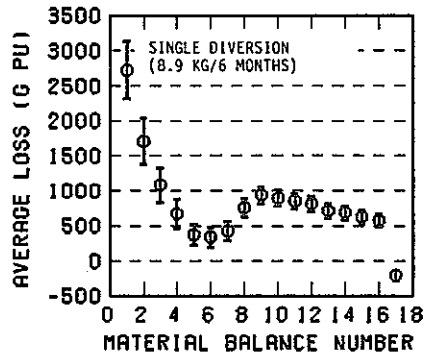
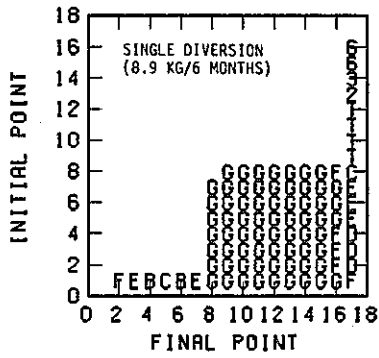
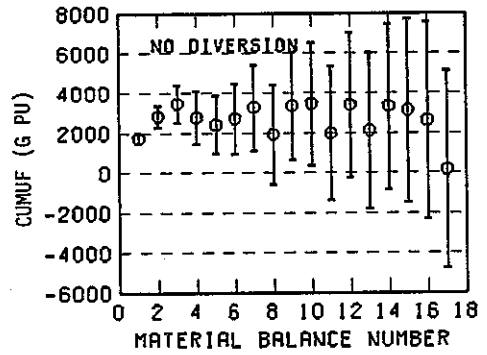
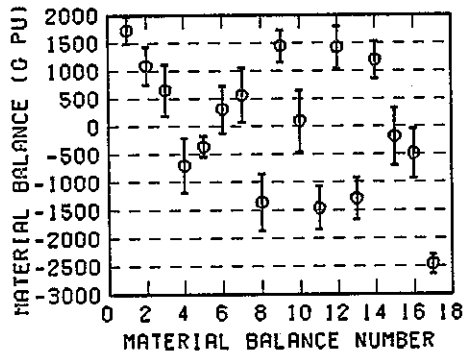

Fig. 5.26 CUMUF and uniform diversion tests for different n.r.t. material balance periods with S.S.1-8 (single diversion (↓) of 8.9 kgs Pu per 6 months).



7 Day-N.R.T.
Material Balance
Period



14 Day-N.R.T.
Material Balance
Period

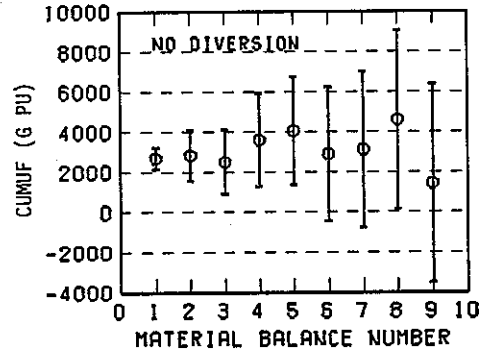
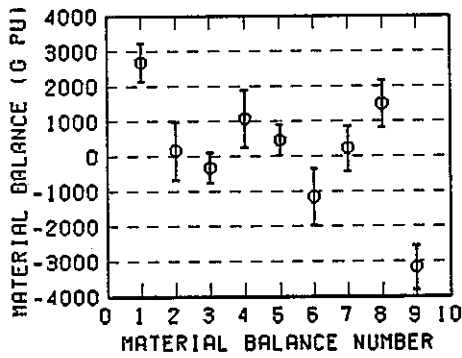

3 Day-N.R.T.
Material Balance
Period

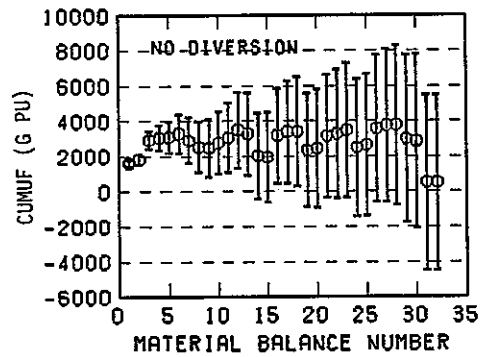
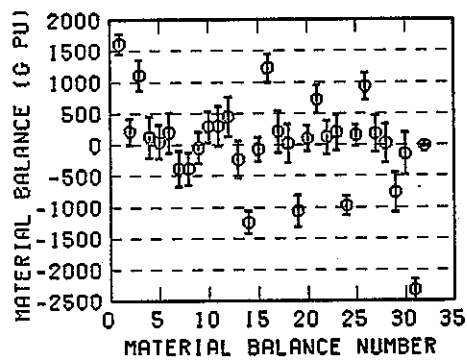
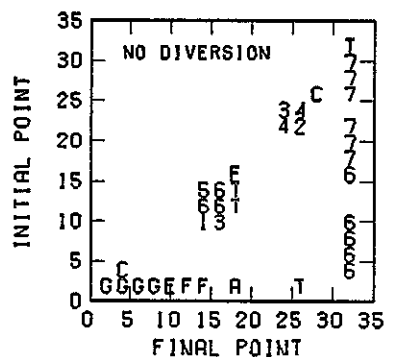
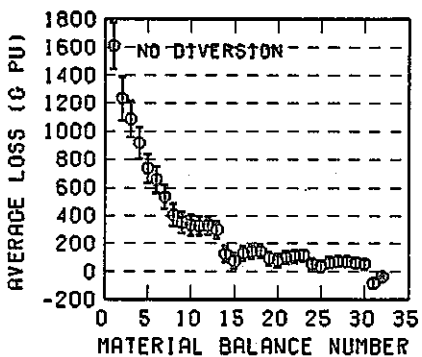
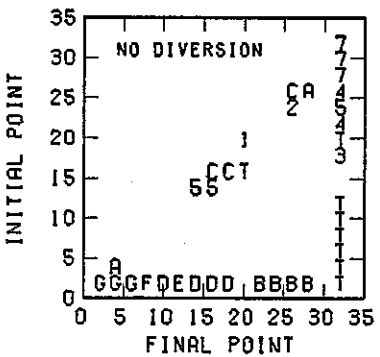
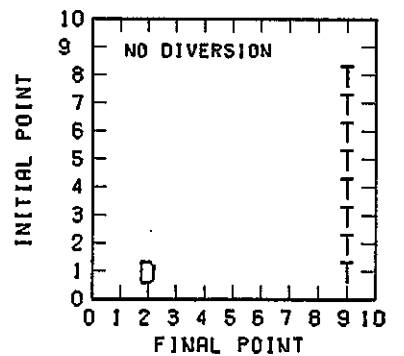
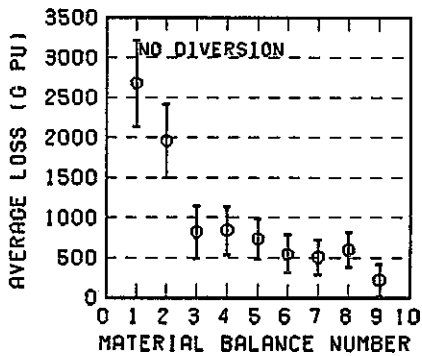
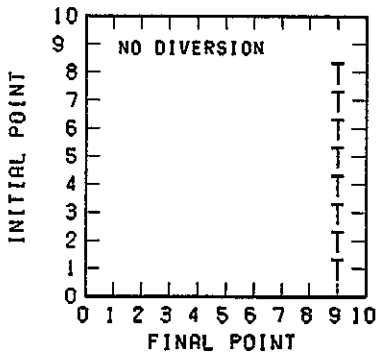
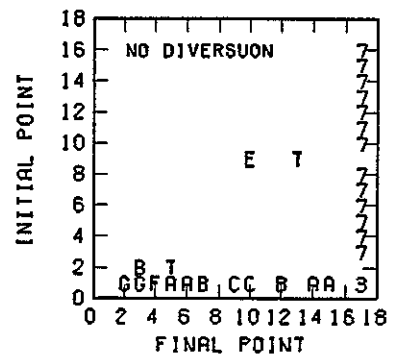
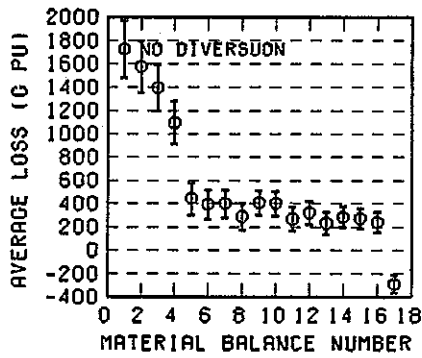
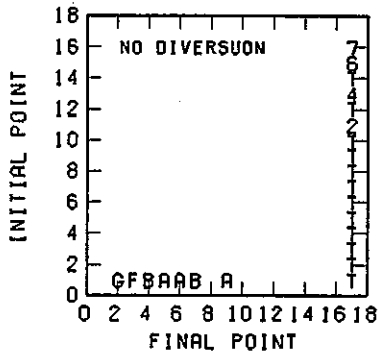
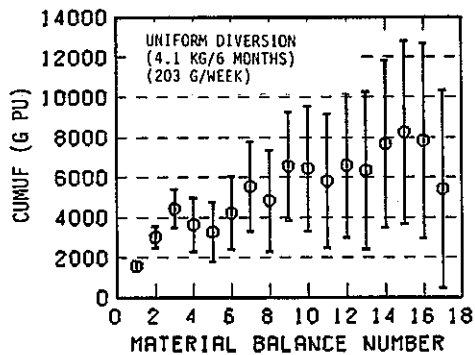
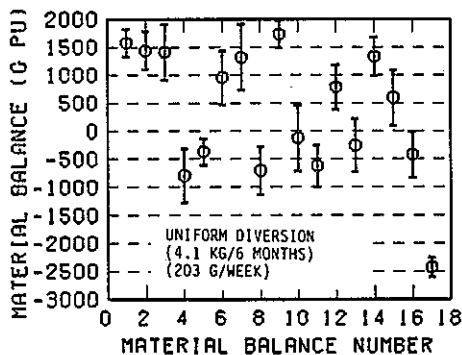

Fig. 5.27 CUMUF and uniform diversion tests for different n.r.t. material balance periods with S.S.4 (no diversion); Simulation period; 6 months.



7 Day-N.R.T.
Material Balance
Period



14 Day-N.R.T.
Material Balance
Period

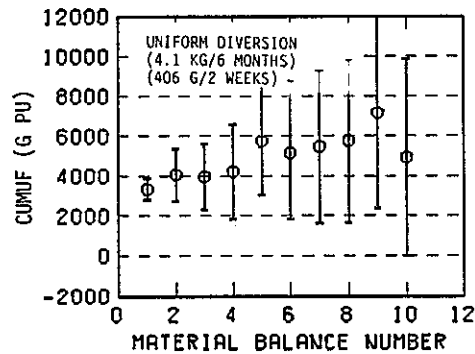
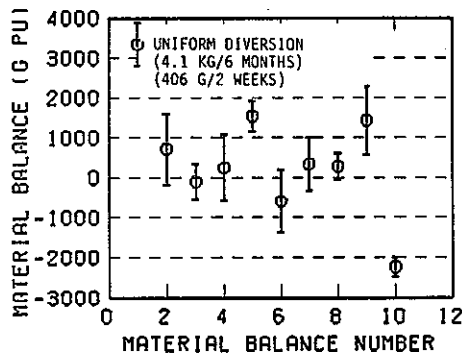

3 Day-N.R.T.
Material Balance
Period

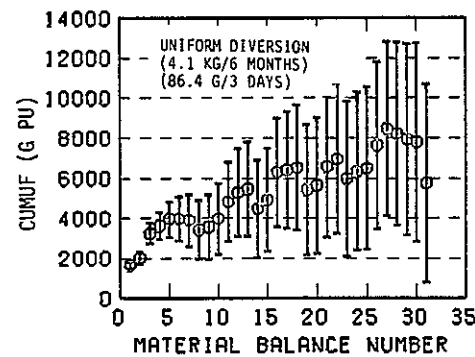
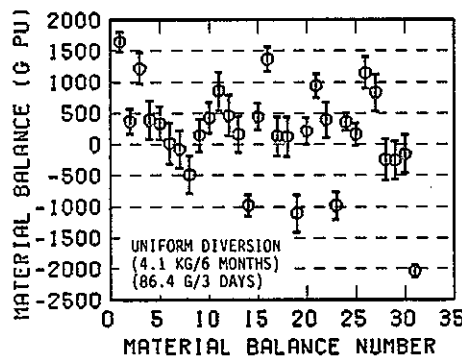
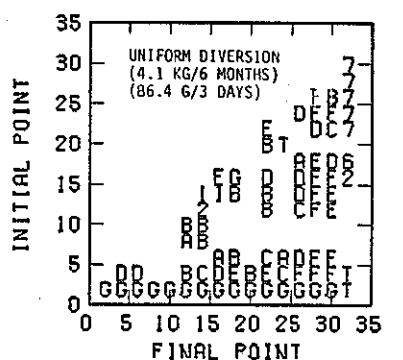
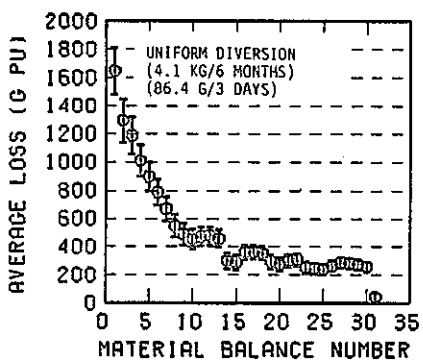
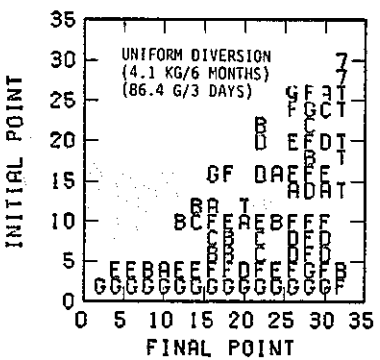
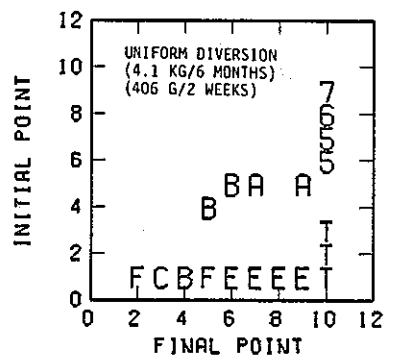
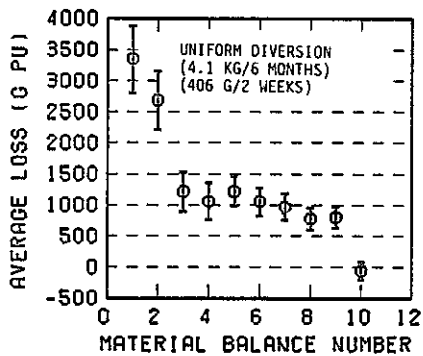
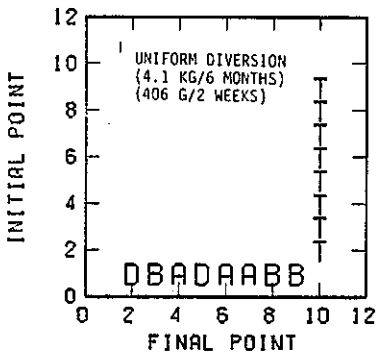
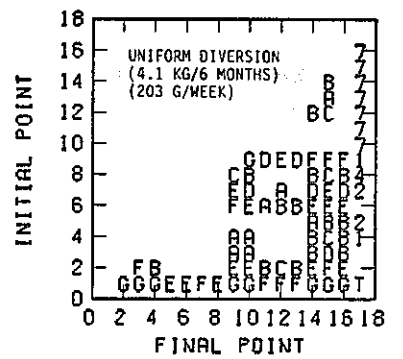
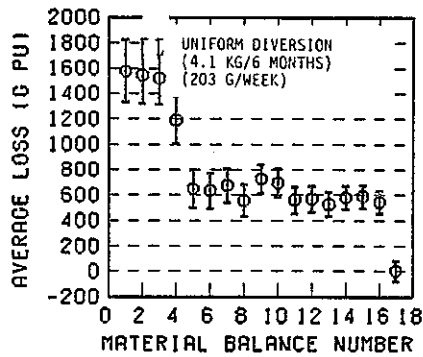
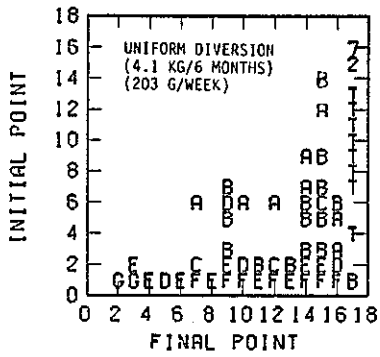
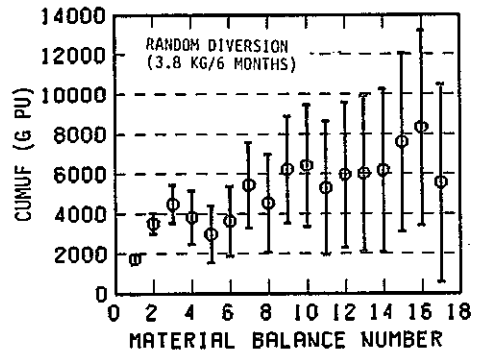
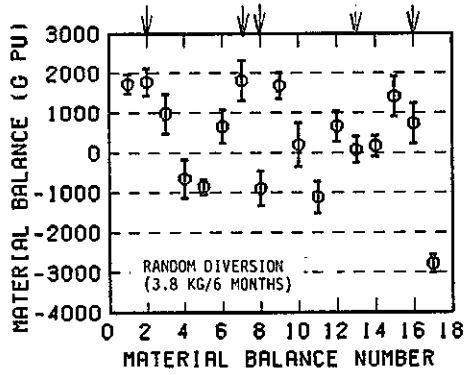

Fig. 5.28 CUMUF and uniform diversion tests for different n.r.t. material balance periods with S.S.4 (uniform diversion of 4.1 kgs Pu per 6 months).



7 Day-N.R.T.
Material Balance
Period



14 Day-N.R.T.
Material Balance
Period

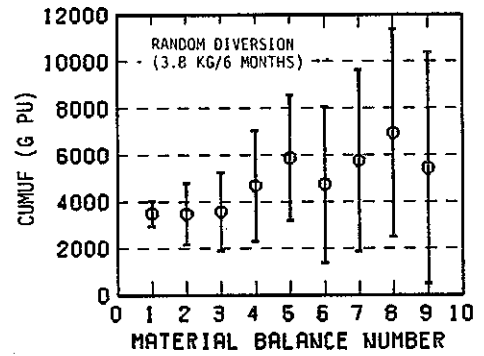
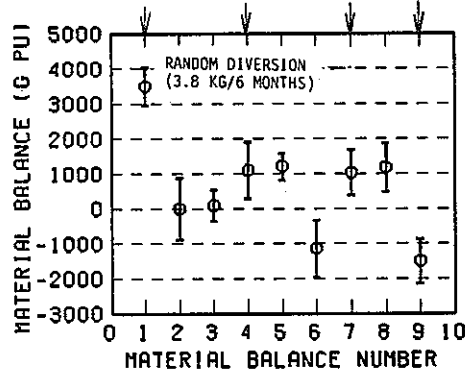

3 Day-N.R.T.
Material Balance
Period

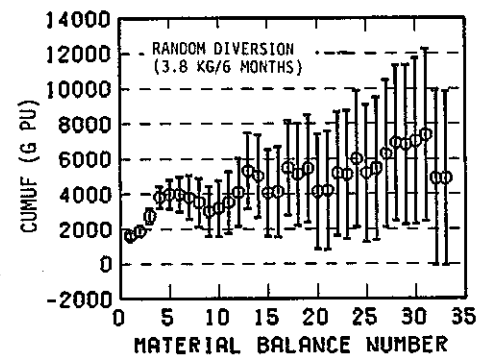
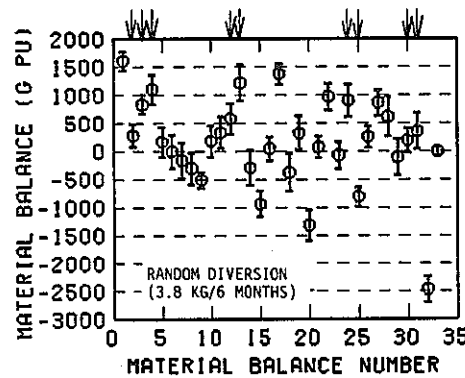
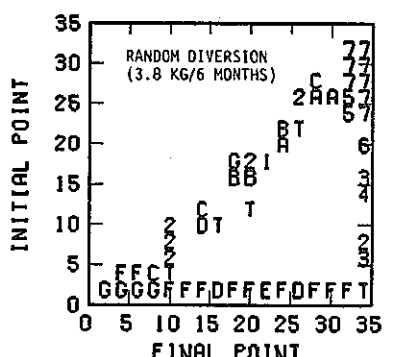
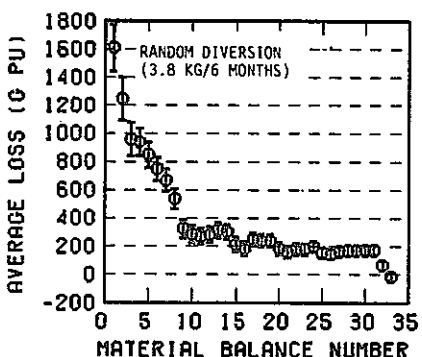
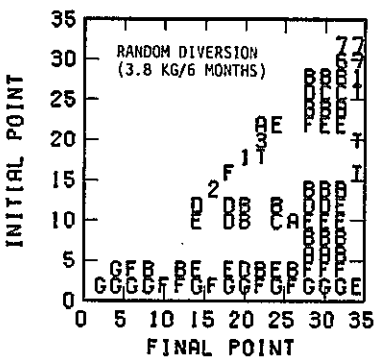
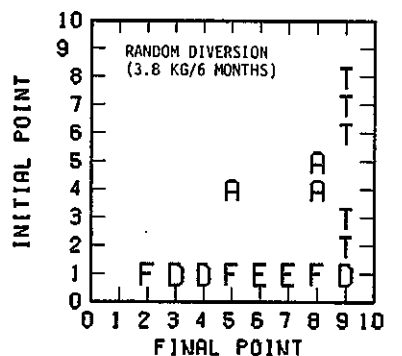
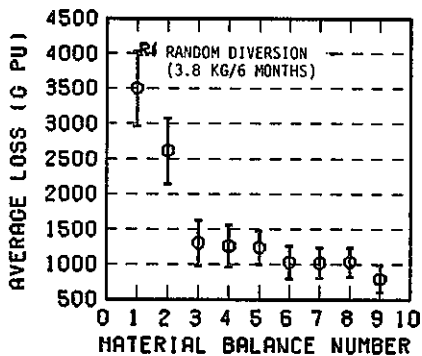
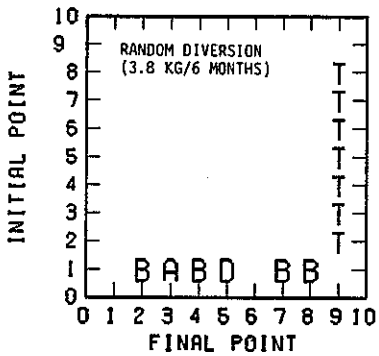
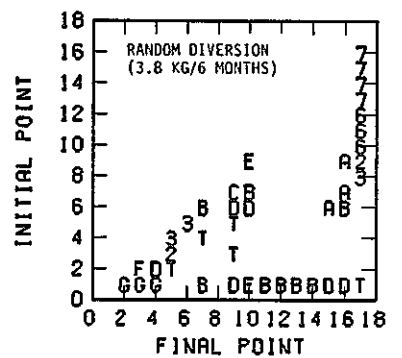
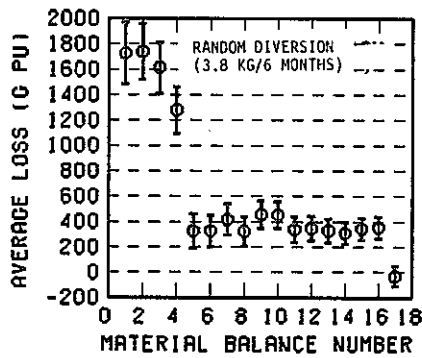
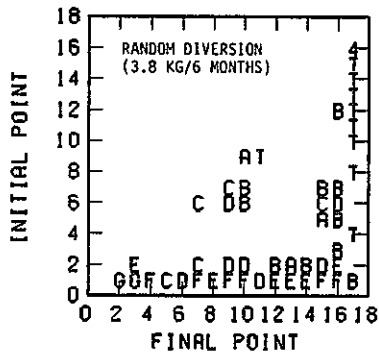
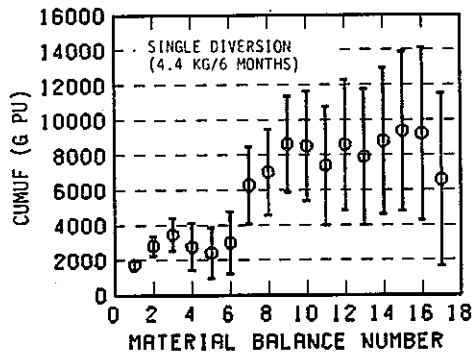
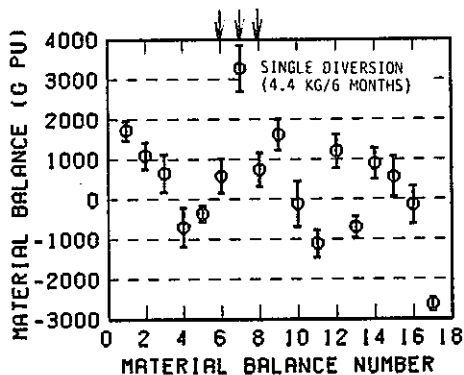

Fig. 5.29 CUMUF and uniform diversion tests for different n.r.t. material balance periods with S.S.4 (uniform diversion (↓) of 3.8 kgs Pu per 6 months).



7 Day-N.R.T.
Material Balance
Period



14 Day-N.R.T.
Material Balance
Period

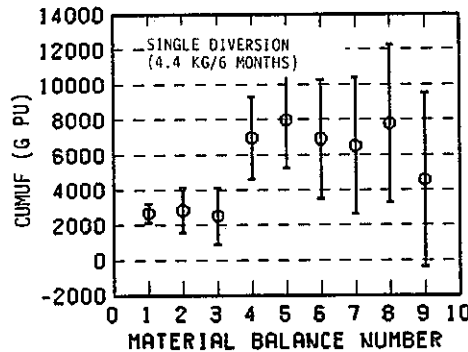
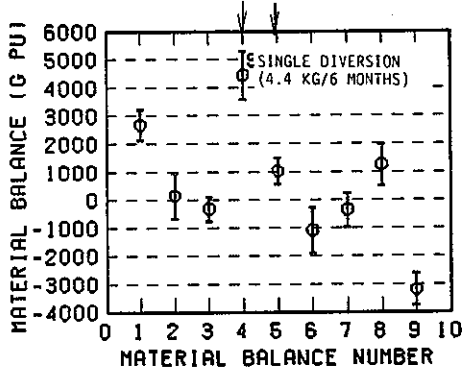

3 Day-N.R.T.
Material Balance
Period

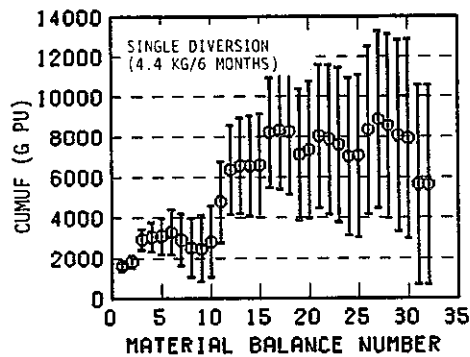
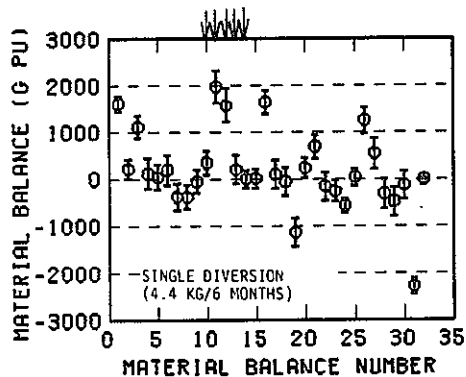
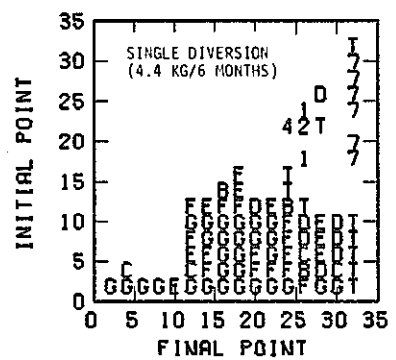
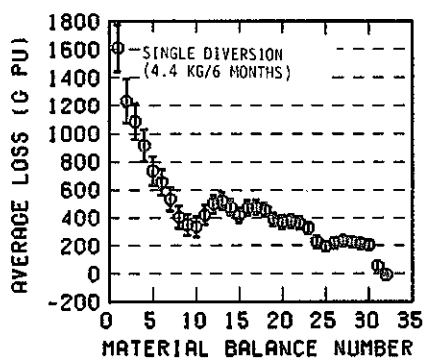
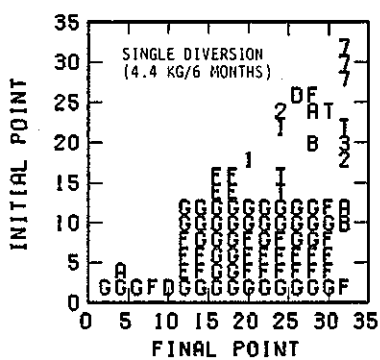
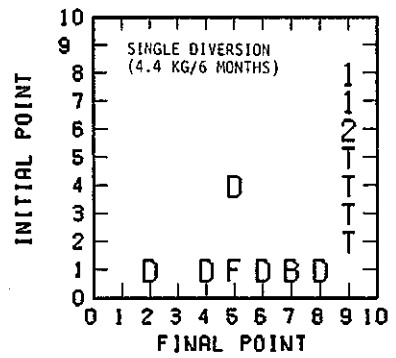
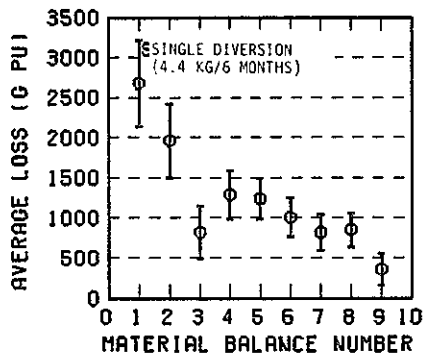
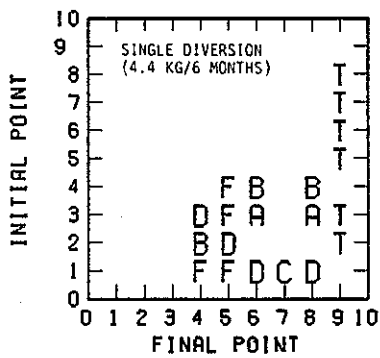
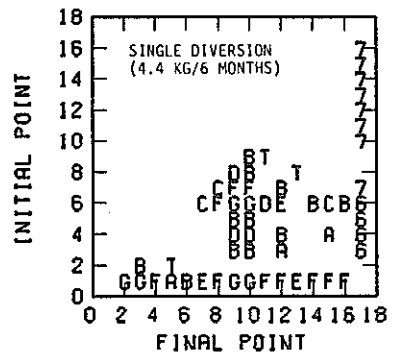
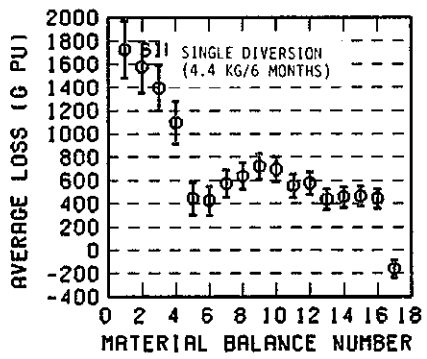
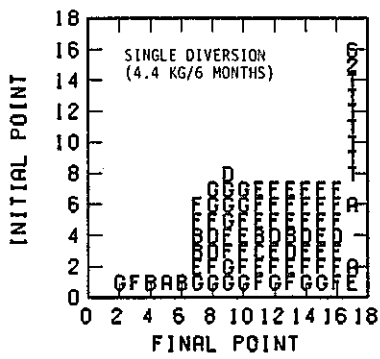
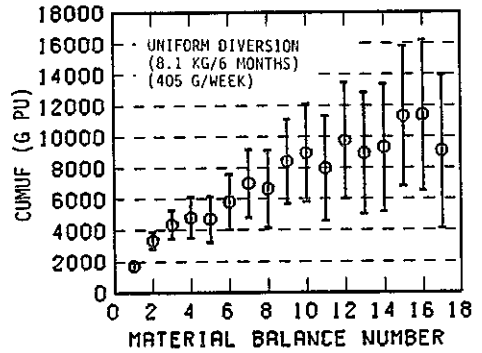
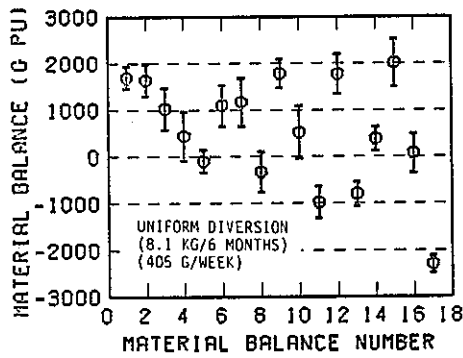

Fig. 5.30 CUMUF and uniform diversion tests for different n.r.t. material balance periods with S.S.4 (single diversion (ψ) of 4.4 kgs Pu per 6 months).



7 Day-N.R.T.
Material Balance
Period



14 Day-N.R.T.
Material Balance
Period

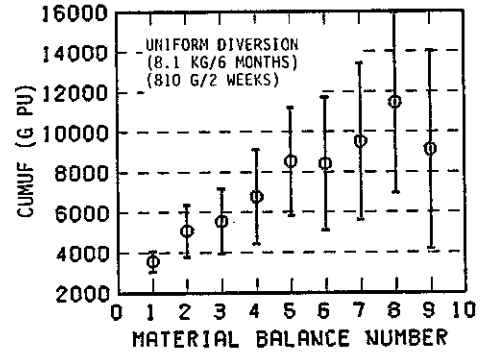
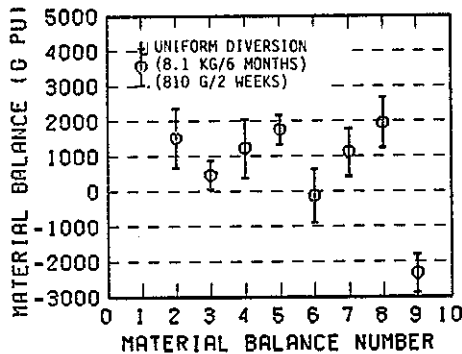

3 Day-N.R.T.
Material Balance
Period

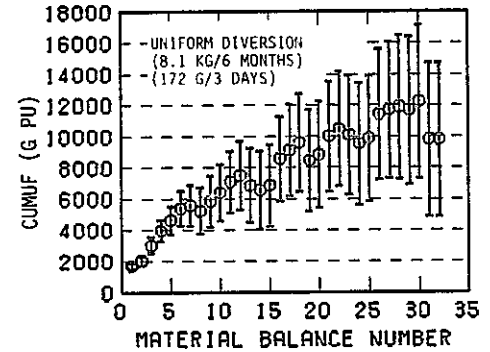
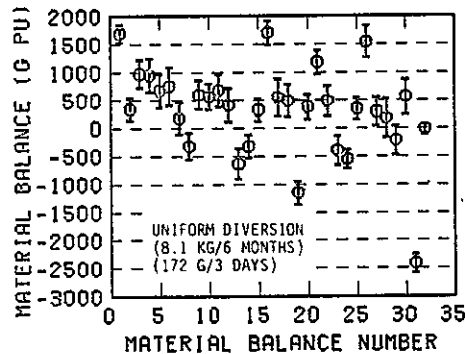
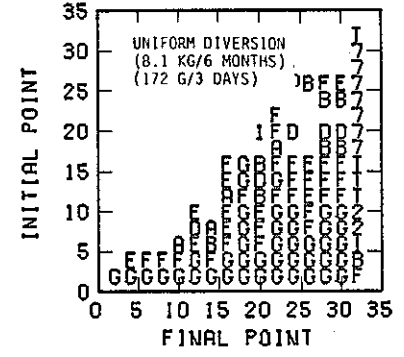
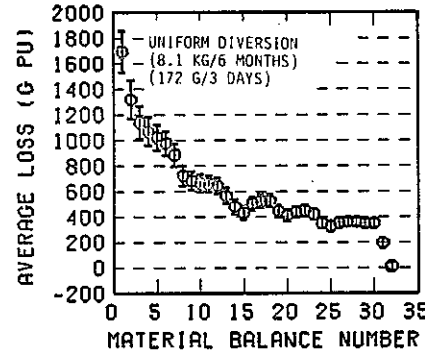
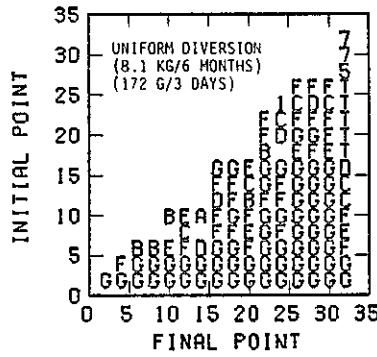
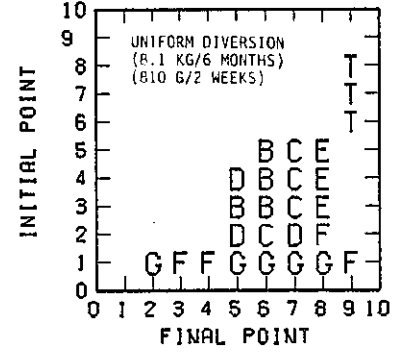
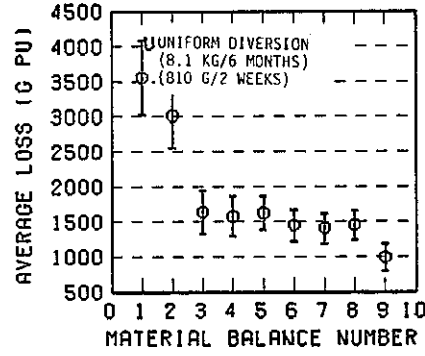
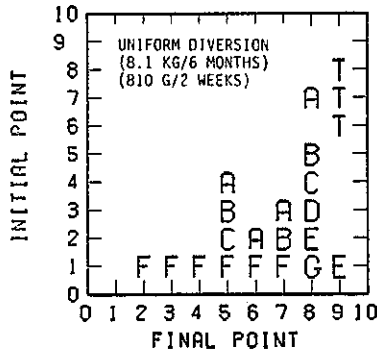
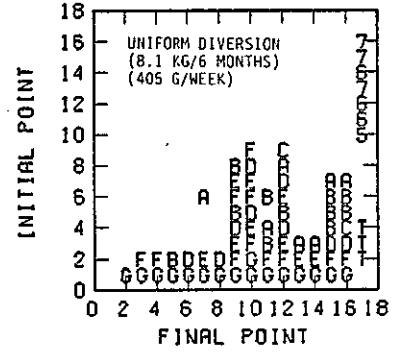
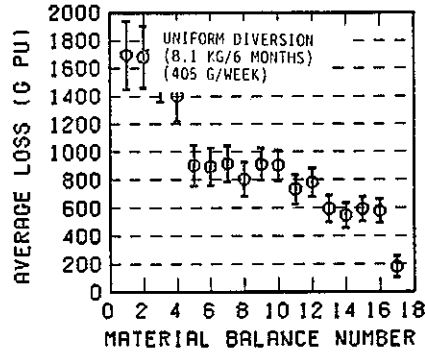
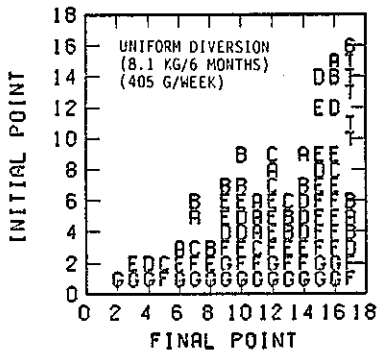
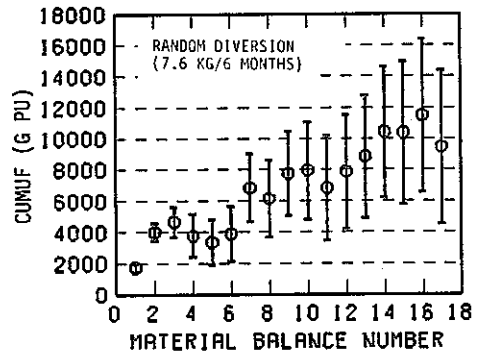
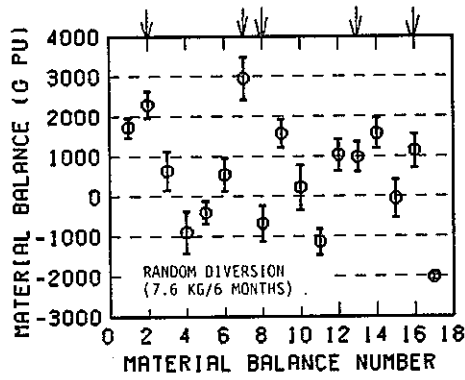

Fig. 5.31 CUMUF and uniform diversion tests for different n.r.t. material balance periods with S.S.4 (uniform diversion of 8.1 kgs Pu per 6 months).



7 Day-N.R.T.
Material Balance
Period



14 Day-N.R.T.
Material Balance
Period

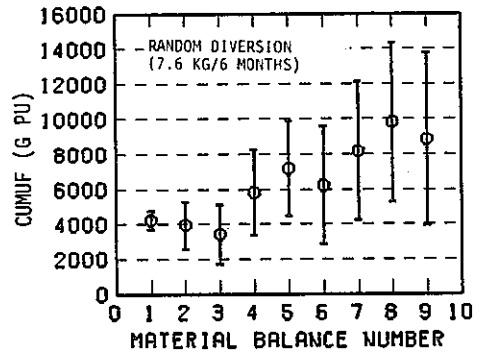
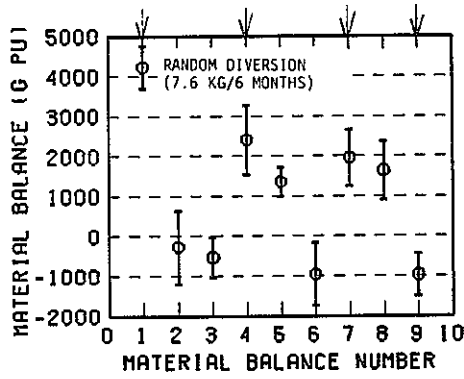

3 Day-N.R.T.
Material Balance
Period

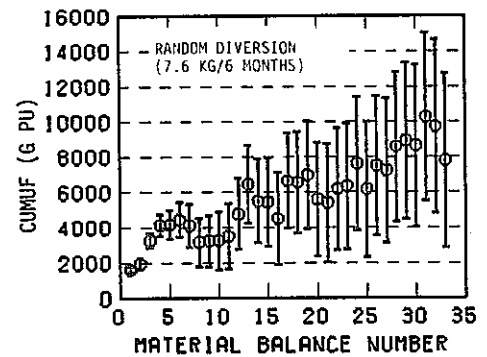
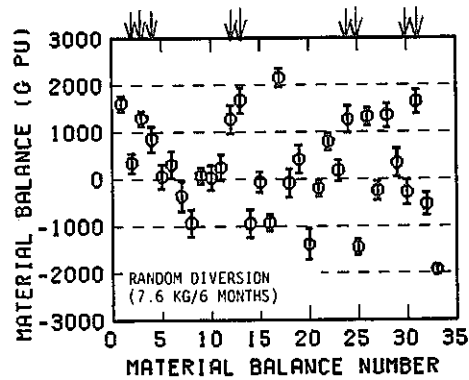
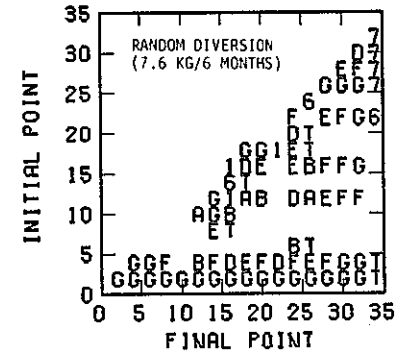
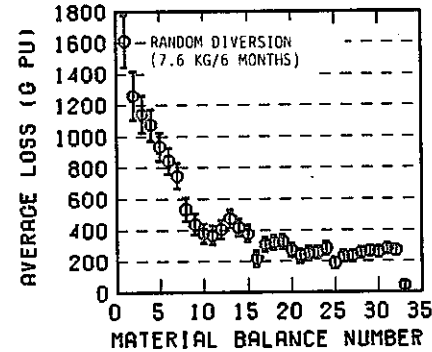
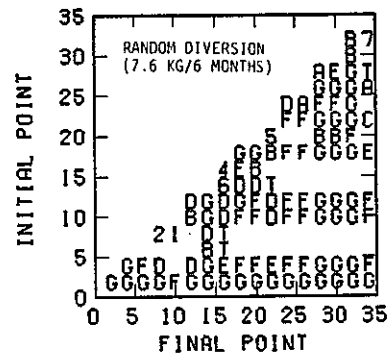
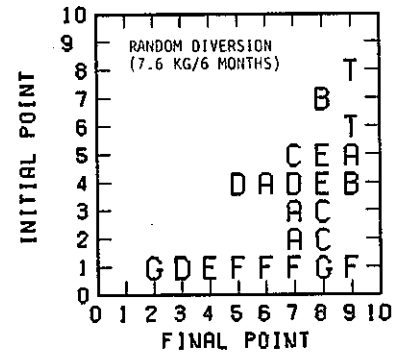
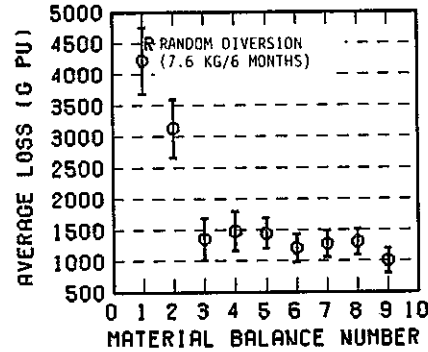
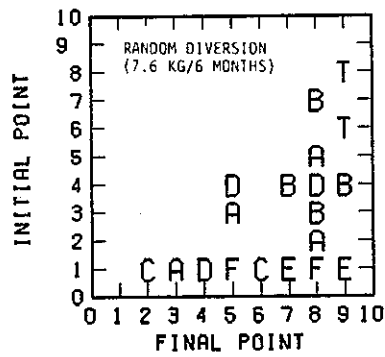
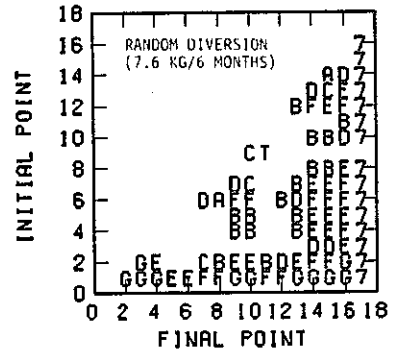
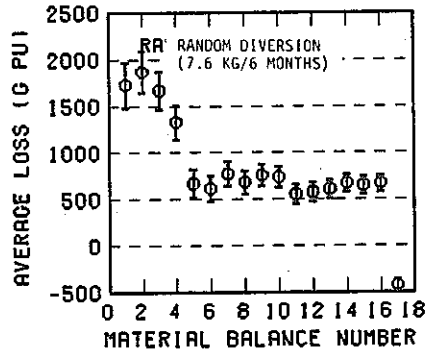
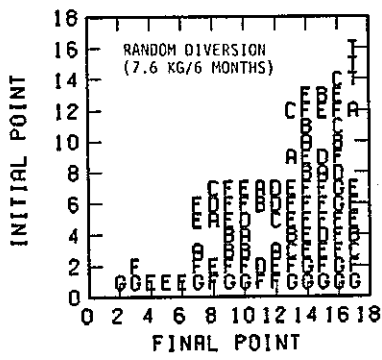
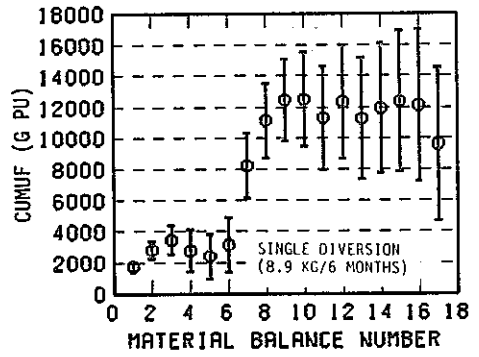
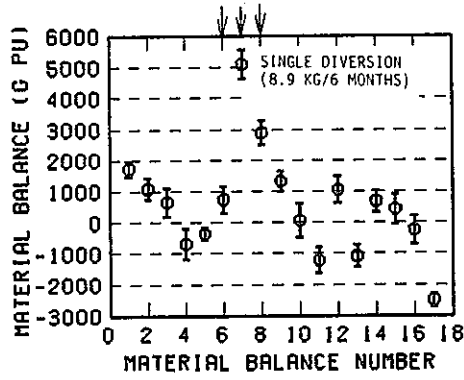

Fig. 5.32 CUMUF and uniform diversion tests for different n.r.t. material balance periods with S.S.4 (random diversion (\downarrow) of 7.6 kgs Pu per 6 months).



7 Day-N.R.T.
Material Balance
Period



14 Day-N.R.T.
Material Balance
Period

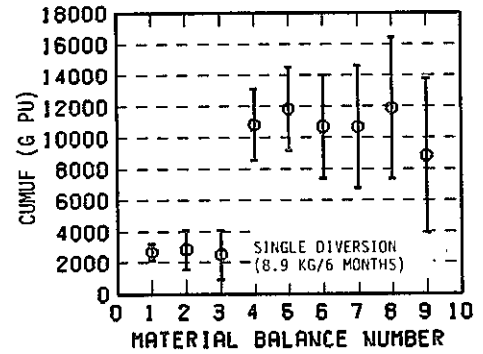
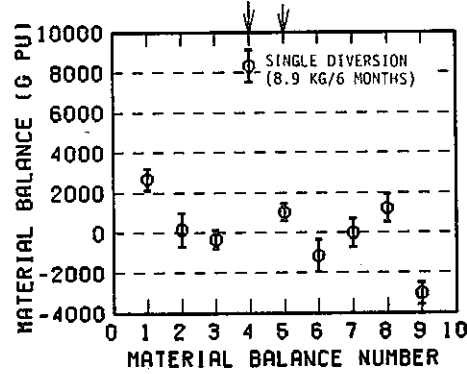

3 Day-N.R.T.
Material Balance
Period

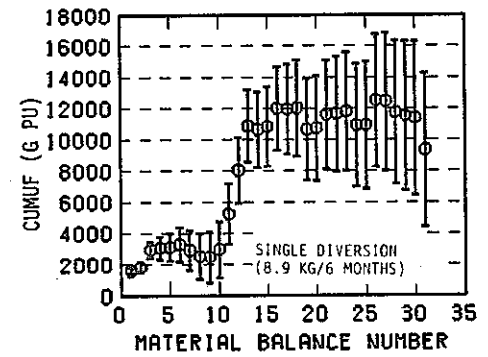
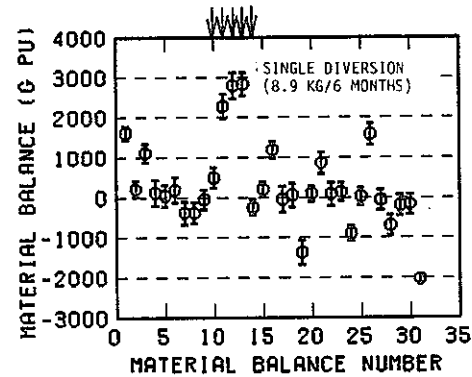
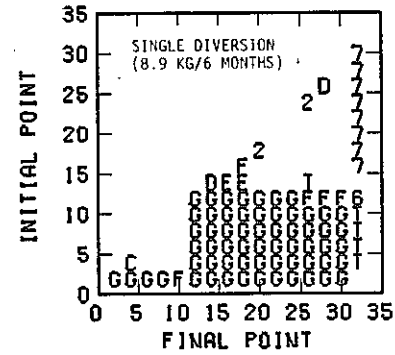
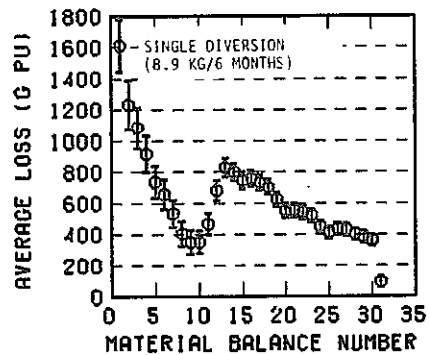
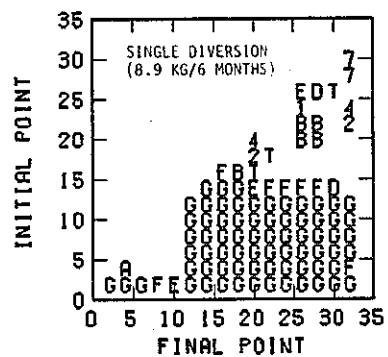
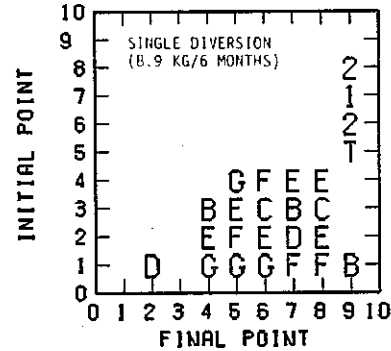
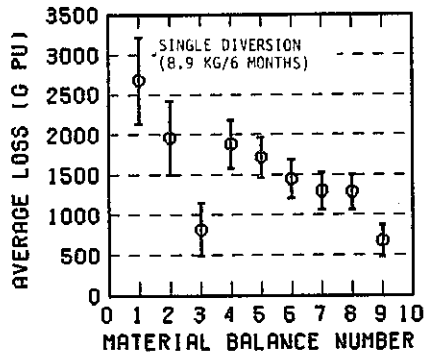
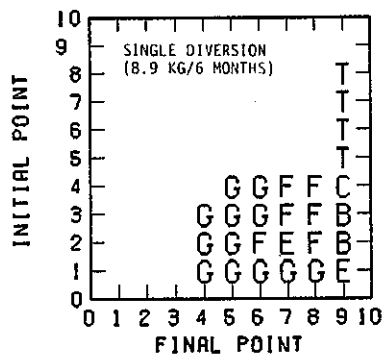
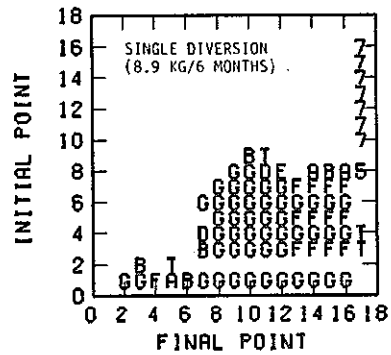
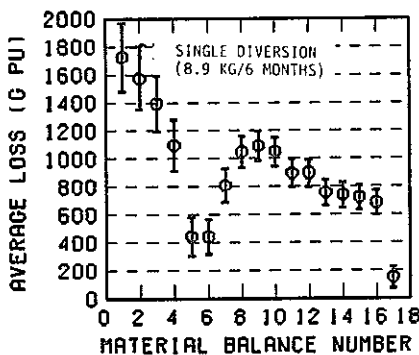
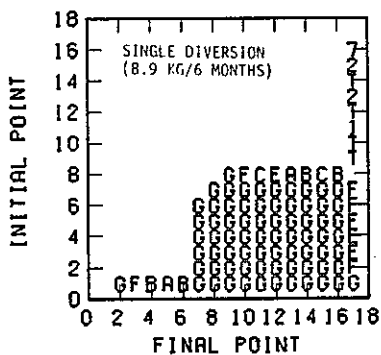
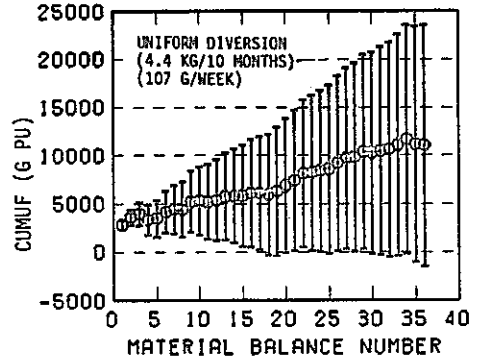
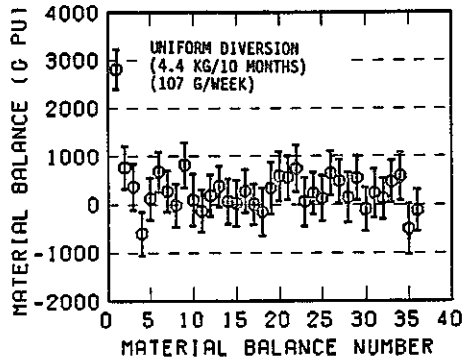

Fig. 5.33 CUMUF and uniform diversion tests for different n.r.t. material balance periods with S.S.4 (single diversion (ψ) of 8.9 kgs Pu per 6 months).



7 Day-N.R.T.
Material Balance
Period



14 Day-N.R.T.
Material Balance
Period

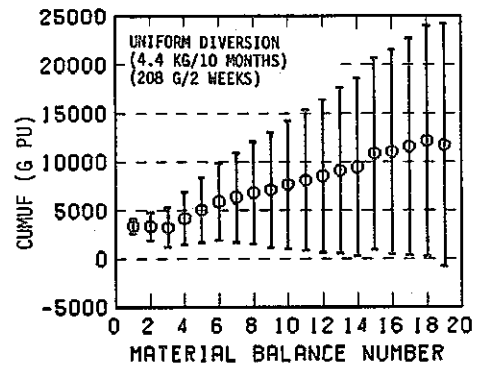
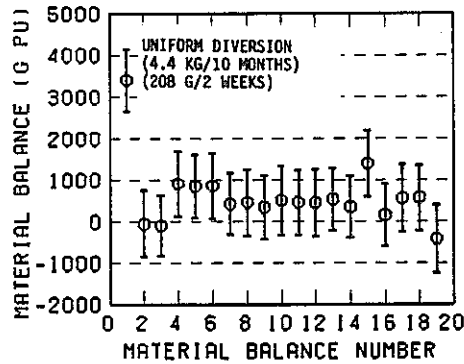

3 Day-N.R.T.
Material Balance
Period

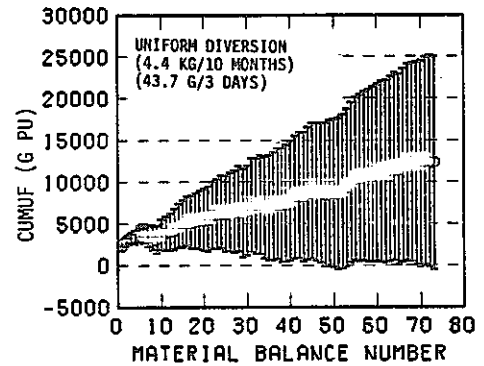
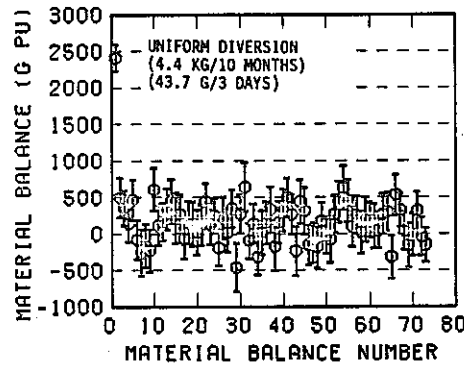

Assumed measurement
Accuracy for
dynamic KMP, D1
is 20 %.

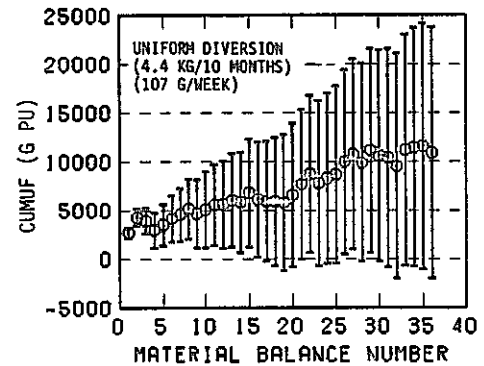
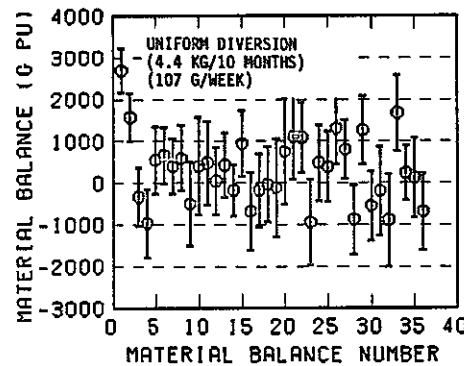
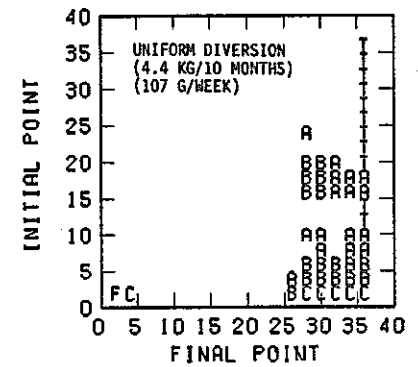
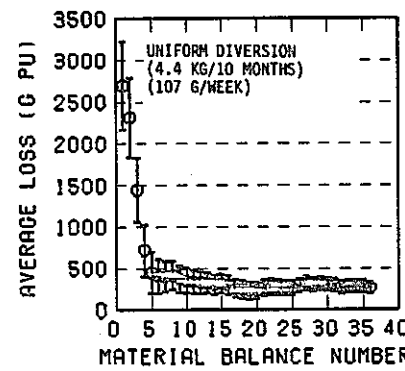
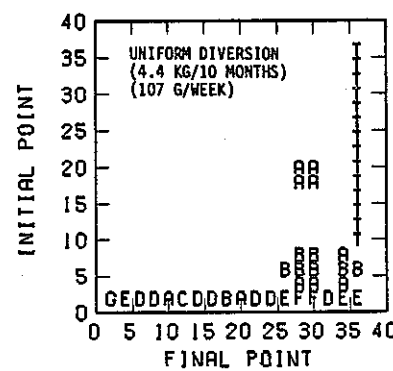
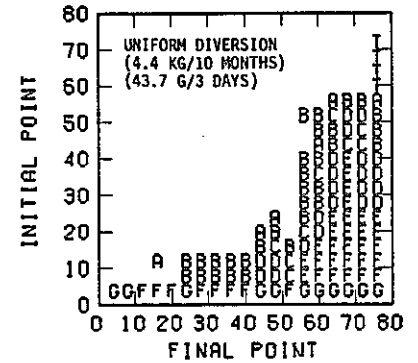
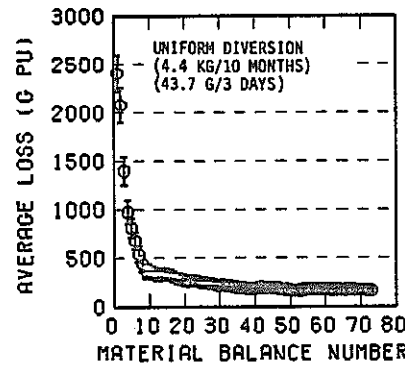
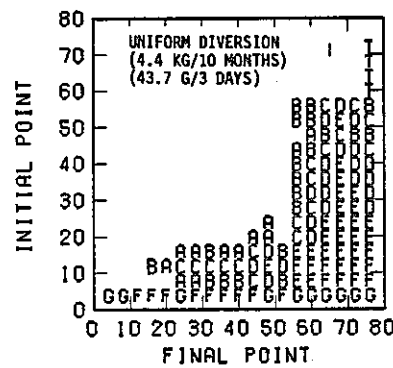
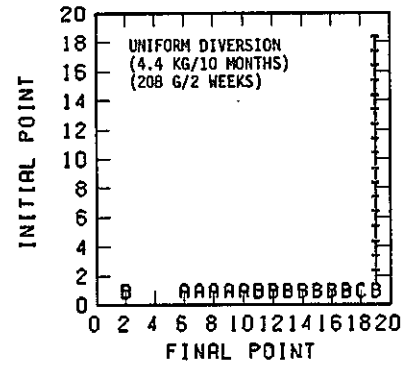
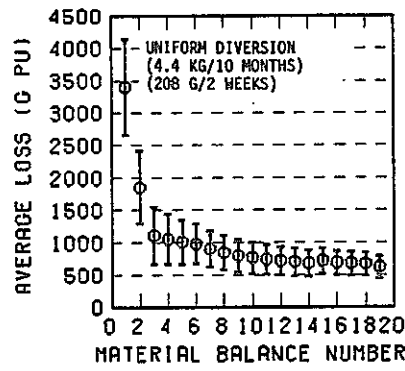
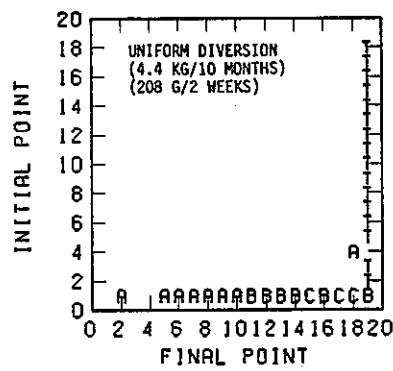
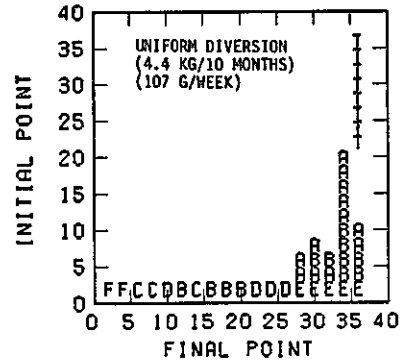
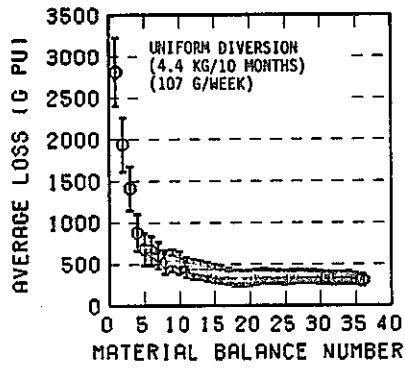
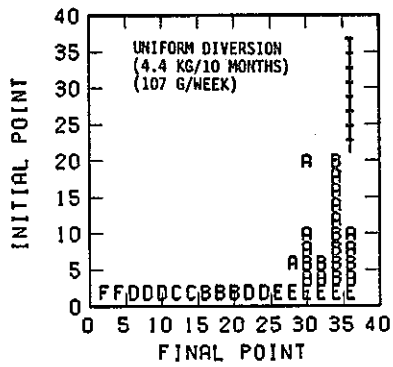
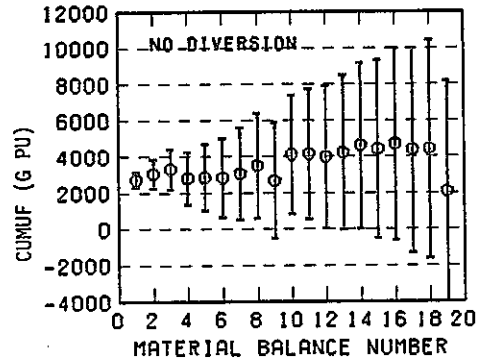
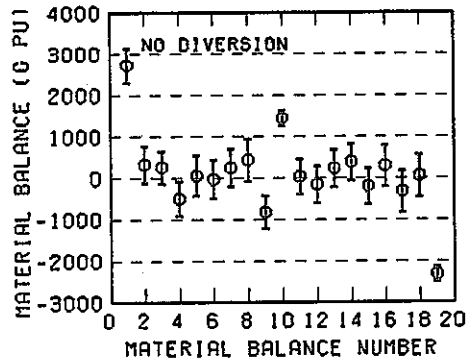

Fig. 5.34 CUMUF and uniform diversion tests for S.S.1-5-2; Simulation period; 10 months.



Partial PIT
Excluded
Mixer-settler
Inventory



Full PIT
Estimation
Accuracy of
Mixer-settler
Inventory
= 20%

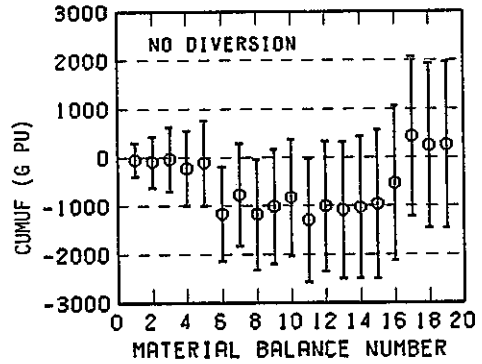
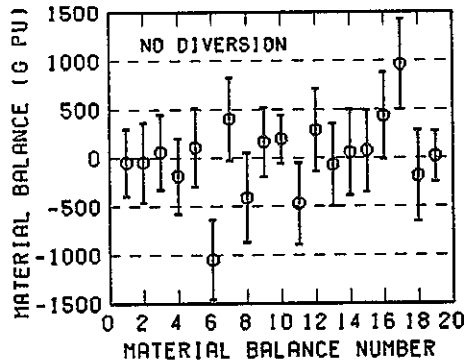

Full PIT
Estimation
Accuracy of
Mixer-settler
Inventory
= 10%

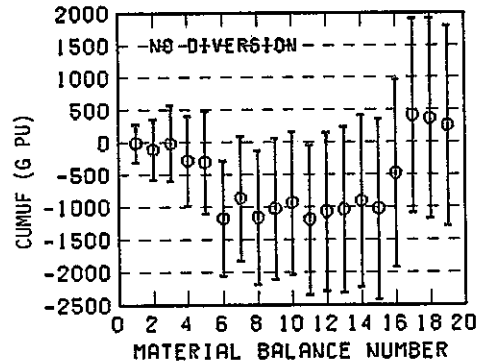
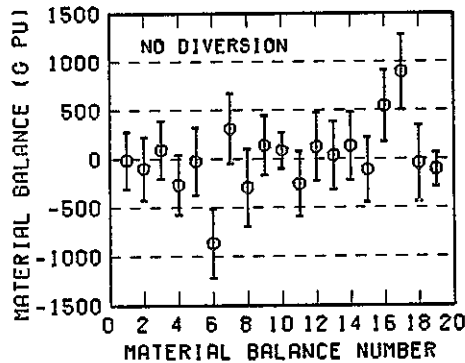

Full PIT
Estimation
Accuracy of
Mixer-settler
Inventory
= 5%

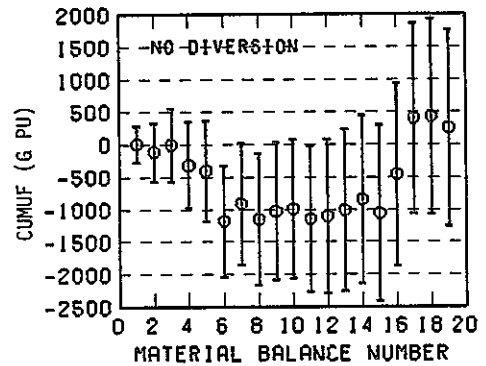
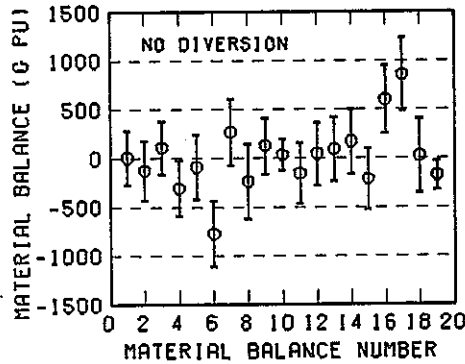
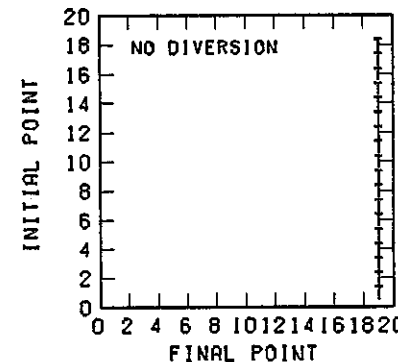
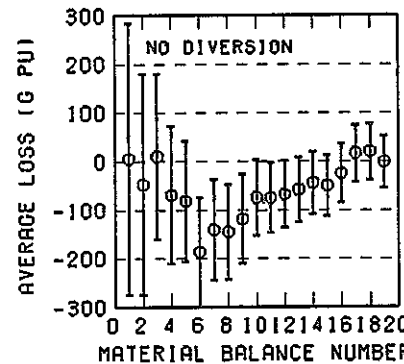
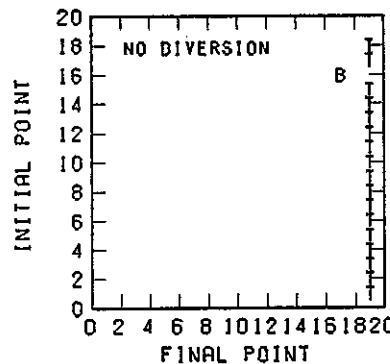
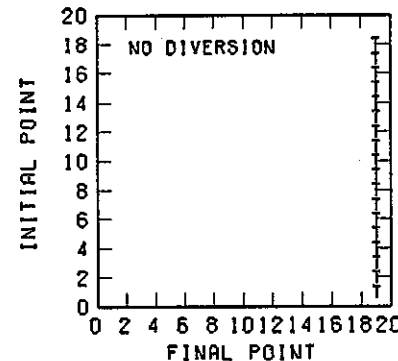
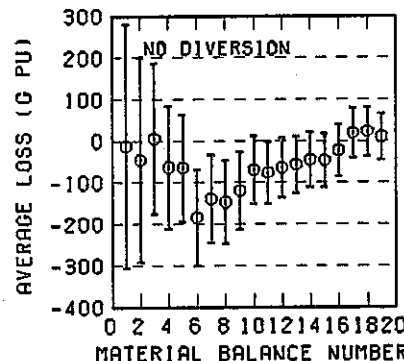
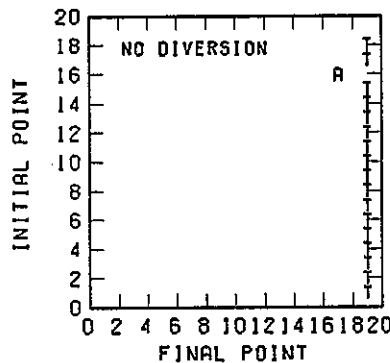
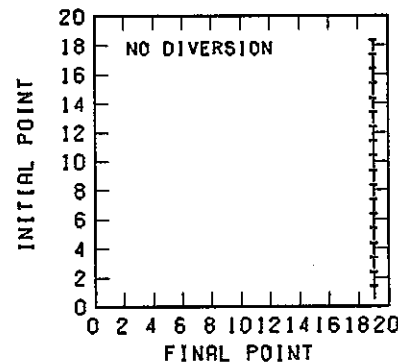
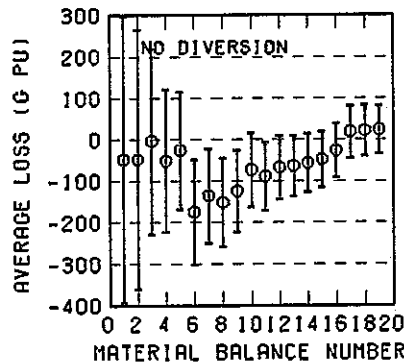
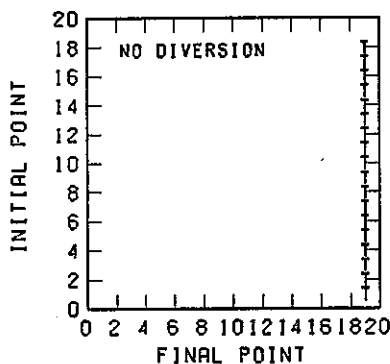
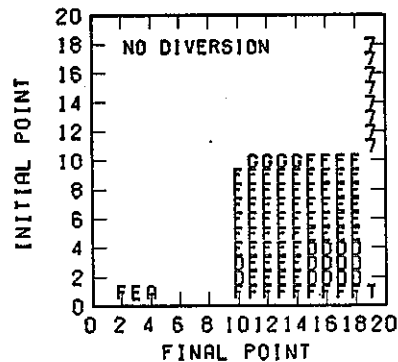
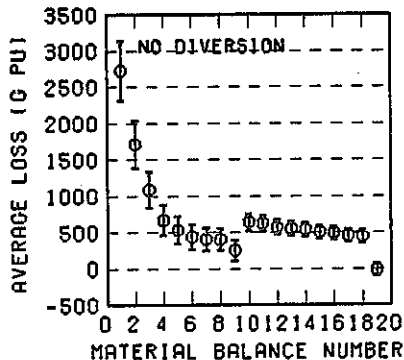
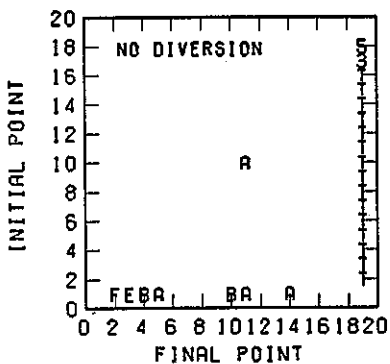
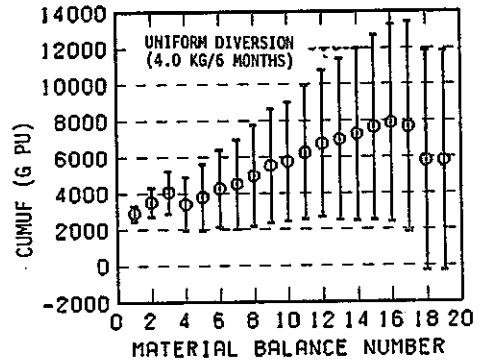
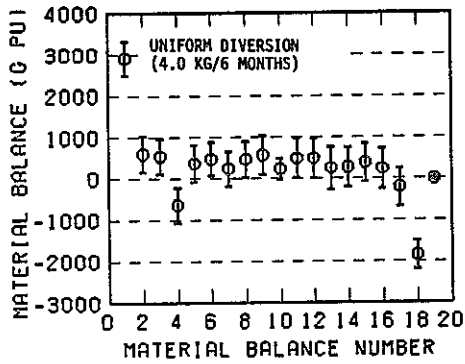

Fig. 5.35 Comparison of detection sensitivities in terms of different in-process PIT models for S.S.1-7 (no diversion).



Partial PIT
Excluded
Mixer-settler
Inventory



Full PIT
Estimation
Accuracy of
Mixer-settler
Inventory
= 20%

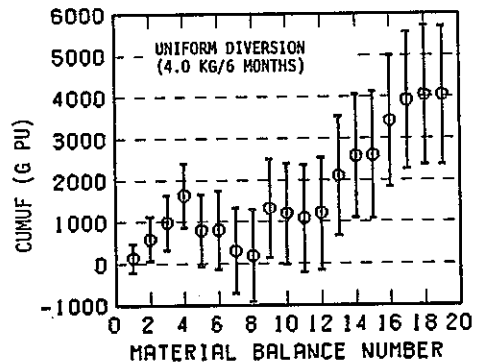
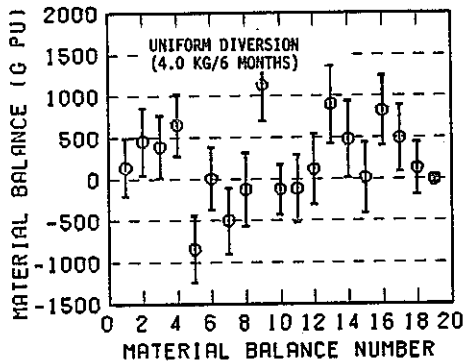

Full PIT
Estimation
Accuracy of
Mixer-settler
Inventory
= 10%

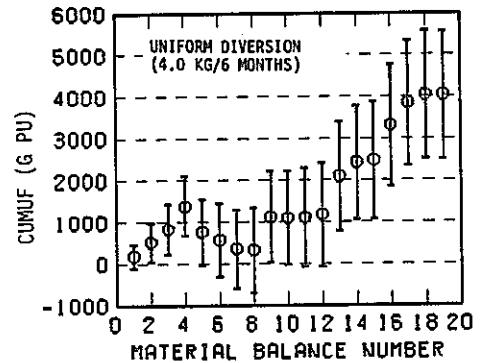
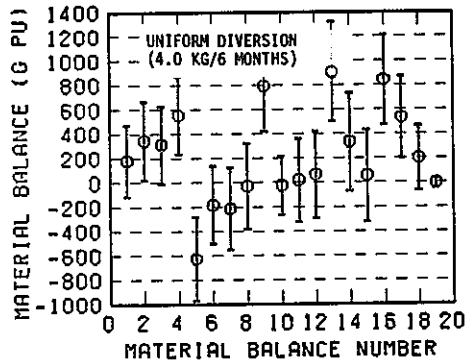

Full PIT
Estimation
Accuracy of
Mixer-settler
Inventory
= 5%

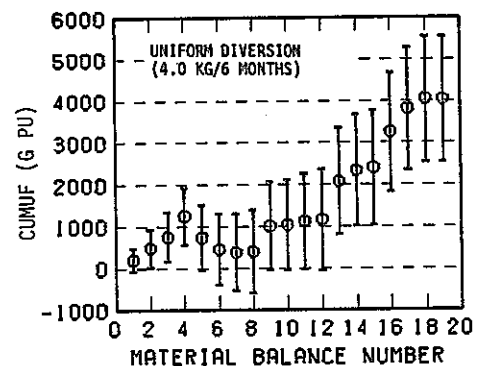
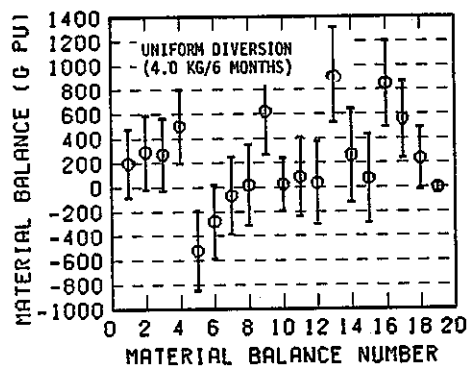
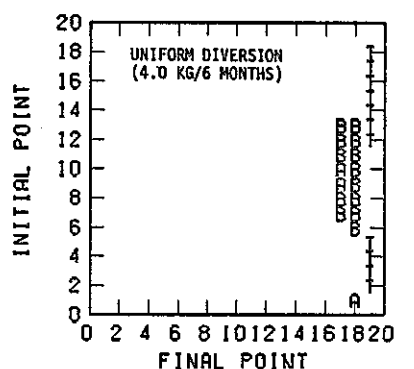
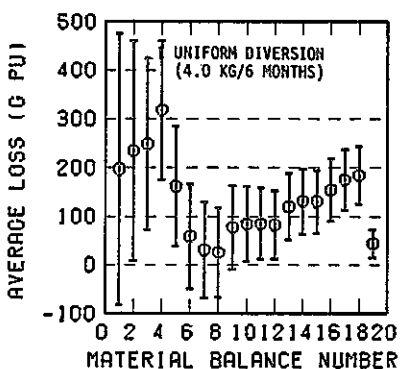
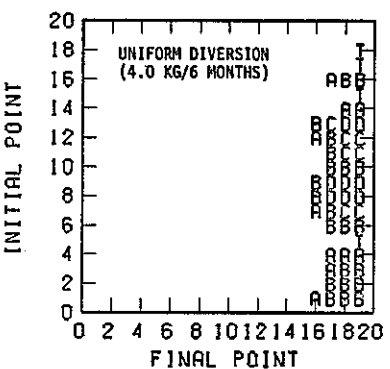
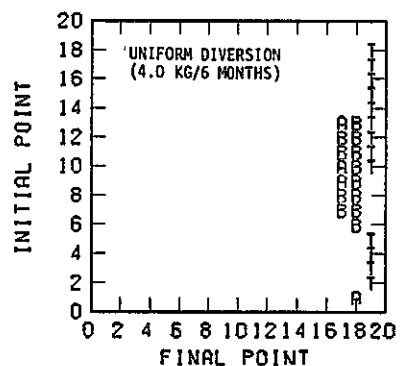
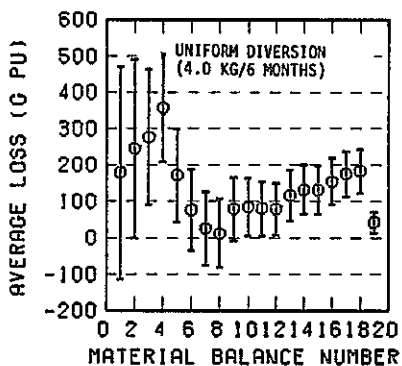
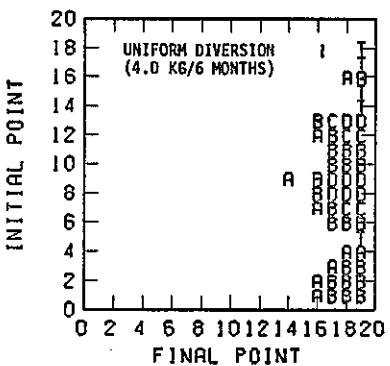
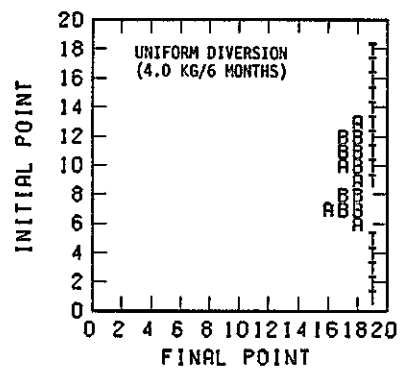
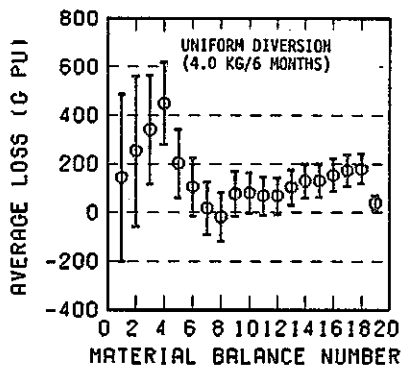
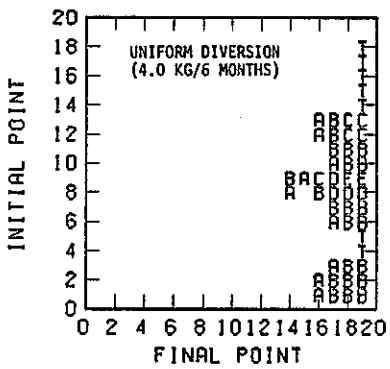
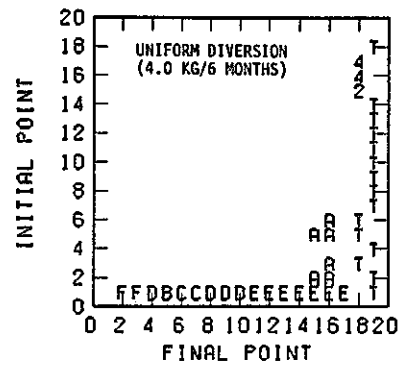
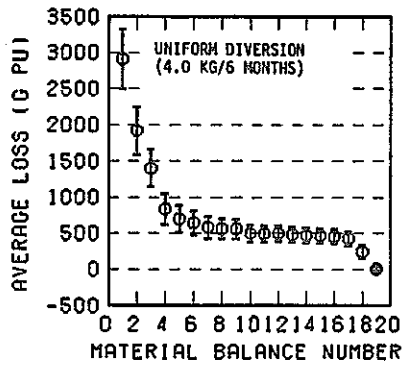
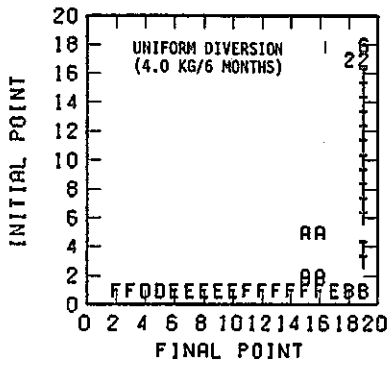
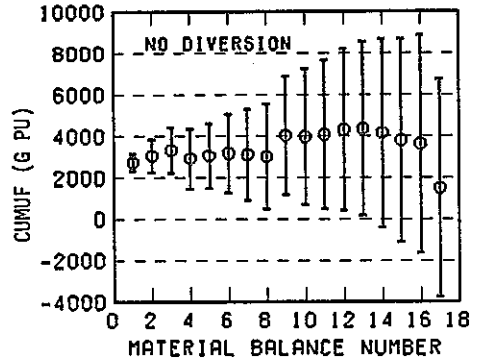
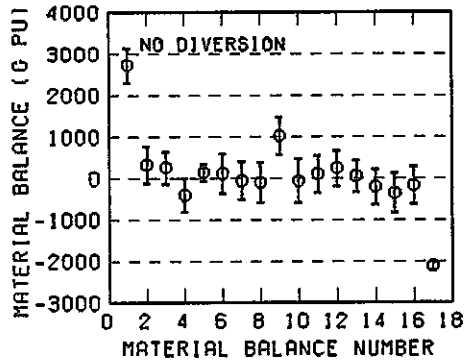

Fig. 5.36 Comparison of detection sensitivities in terms of different in-process PIT models for S.S.1-7 (uniform diversion of 4.0 kgs Pu per 6 months).



Partial PIT
Excluded
Mixer-settler
Inventory



Full PIT
Estimation
Accuracy of
Mixer-settler
Inventory
= 20%

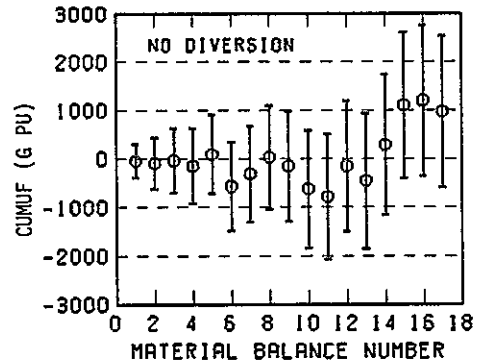
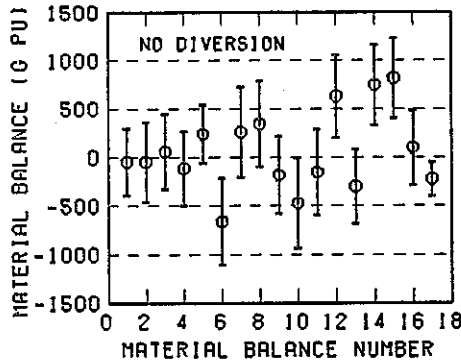

Full PIT
Estimation
Accuracy of
Mixer-settler
Inventory
= 10%

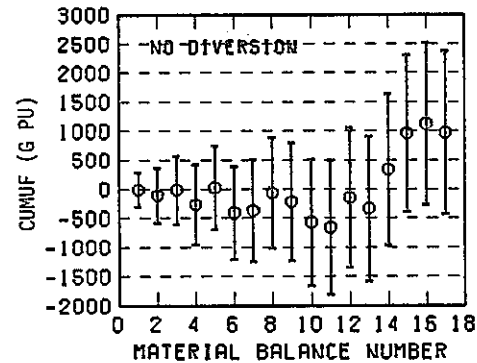
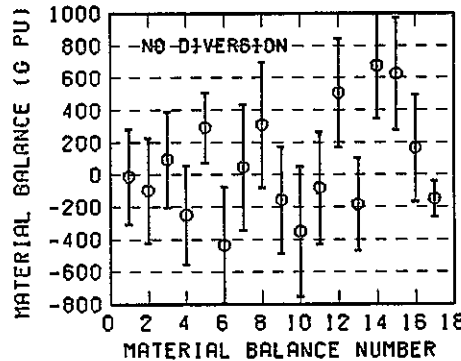

Full PIT
Estimation
Accuracy of
Mixer-settler
Inventory
= 5%

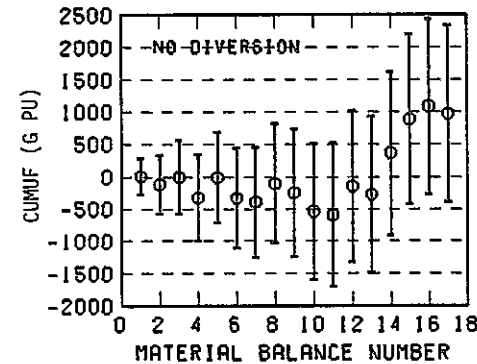
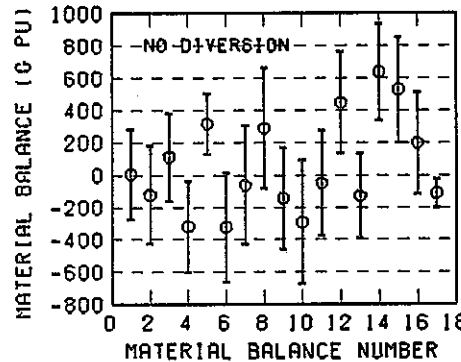
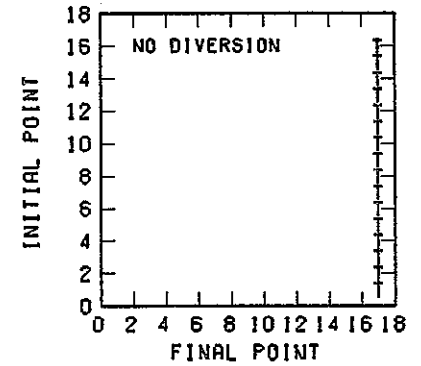
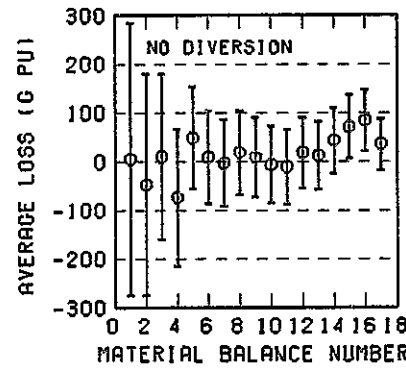
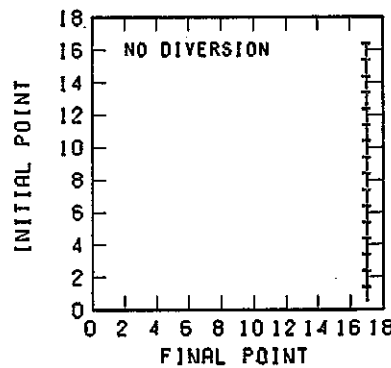
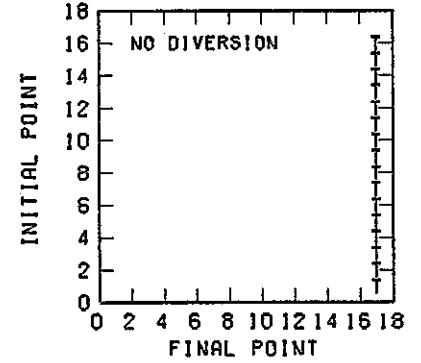
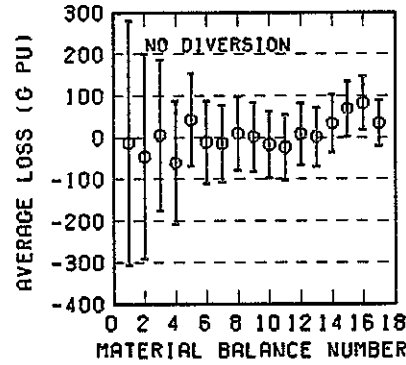
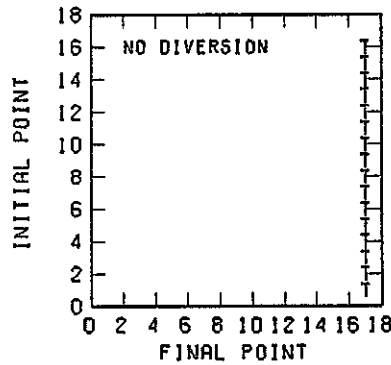
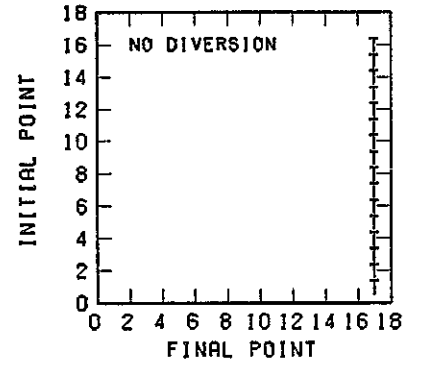
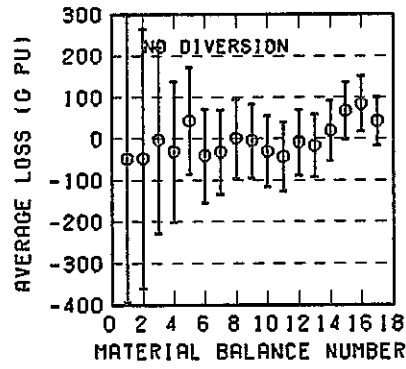
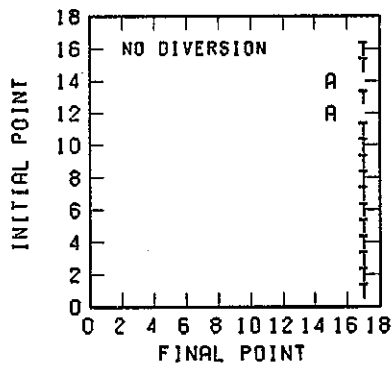
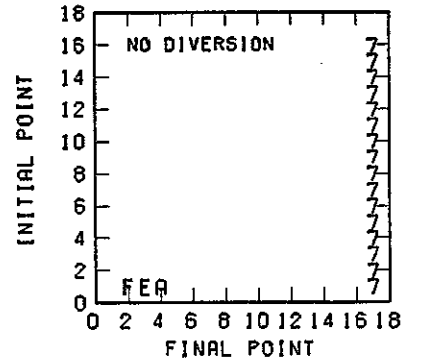
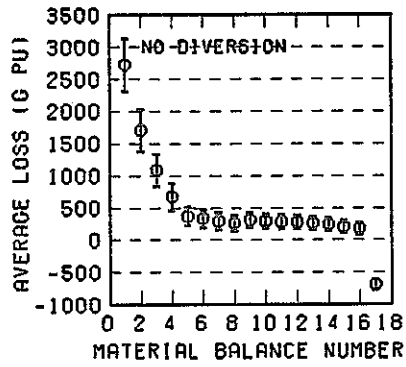
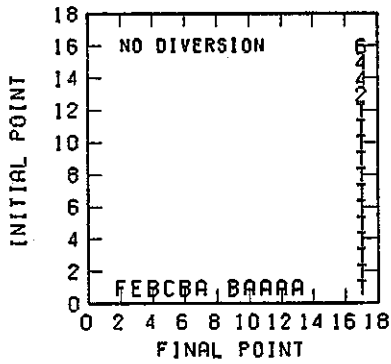
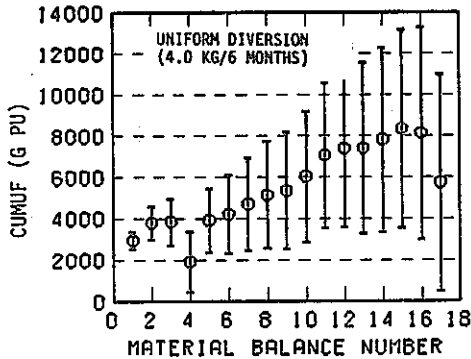
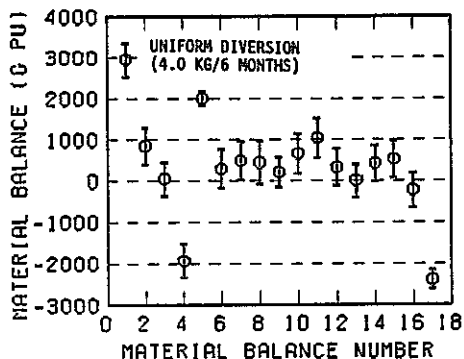

Fig. 5.37 Comparison of detection sensitivities in terms of different in-process PIT models for S.S.1-8 (no diversion).



Partial PIT
Excluded
Mixer-settler
Inventory



Full PIT
Estimation
Accuracy of
Mixer-settler
Inventory
= 20%

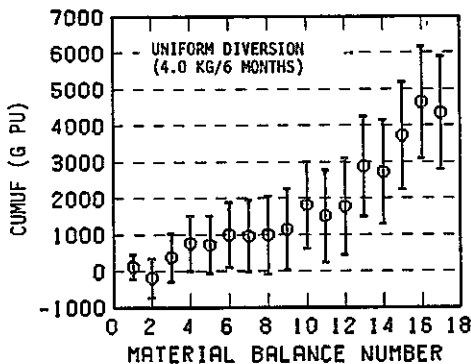
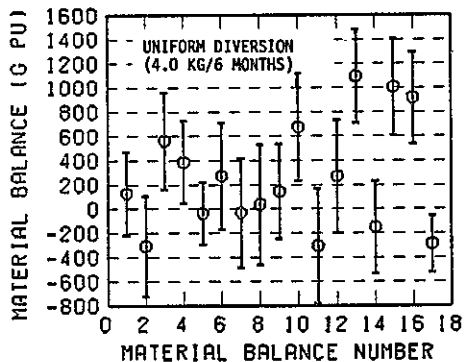

Full PIT
Estimation
Accuracy of
Mixer-settler
Inventory
= 10%

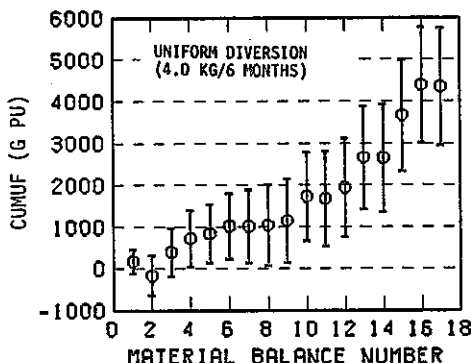
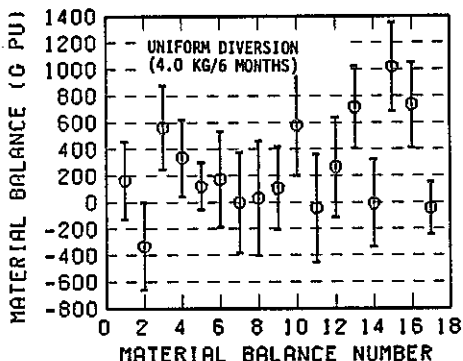

Full PIT
Estimation
Accuracy of
Mixer settler
Inventory
= 5%

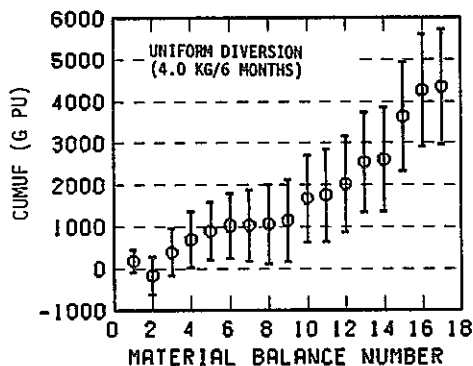
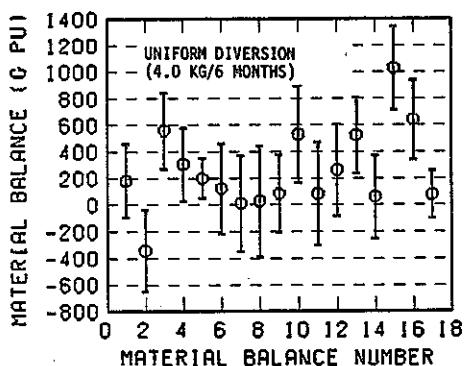
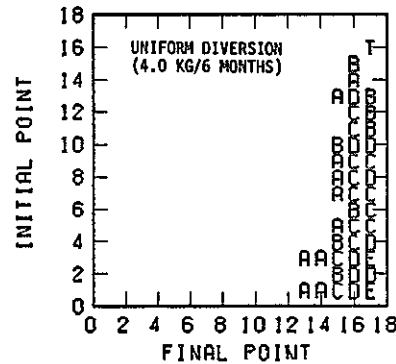
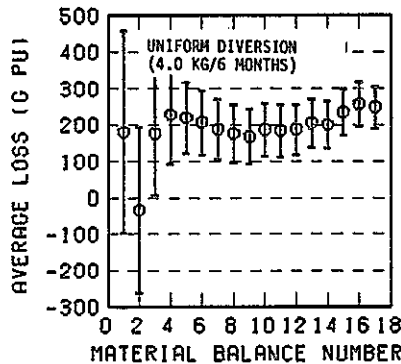
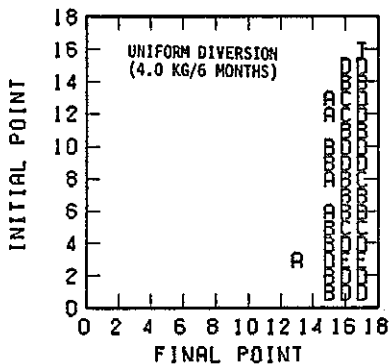
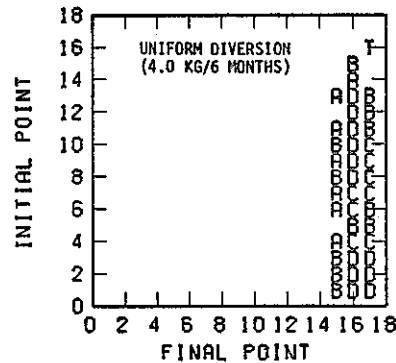
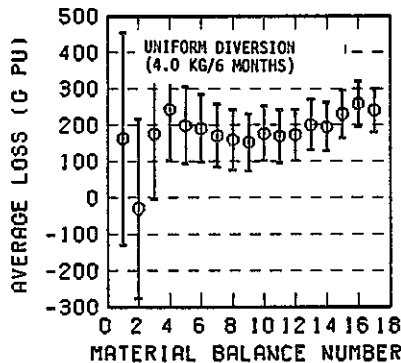
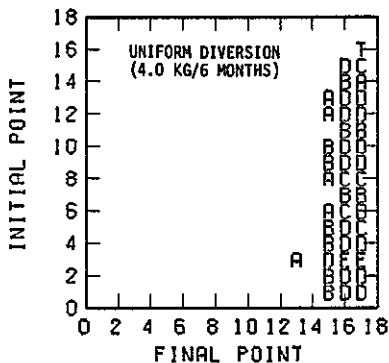
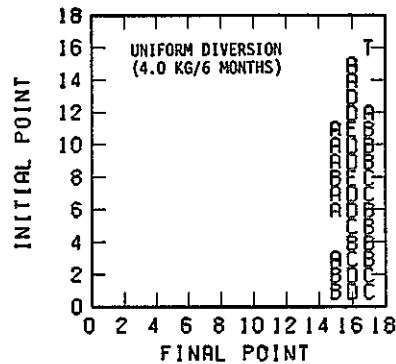
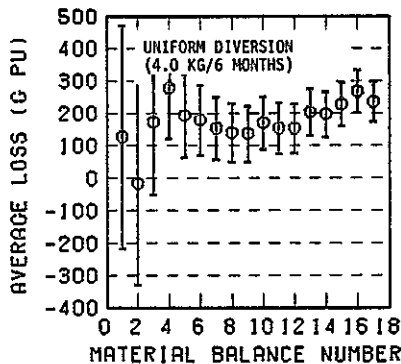
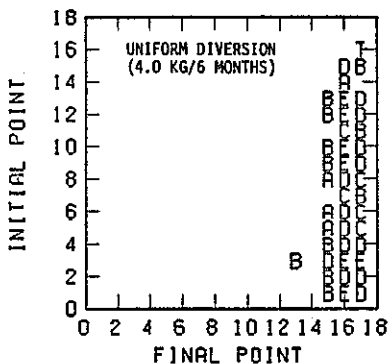
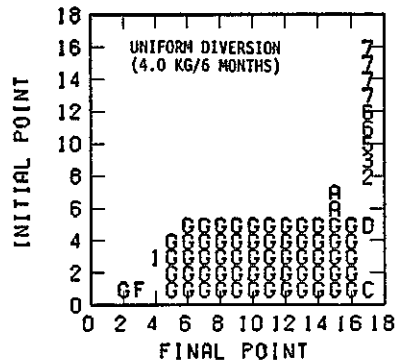
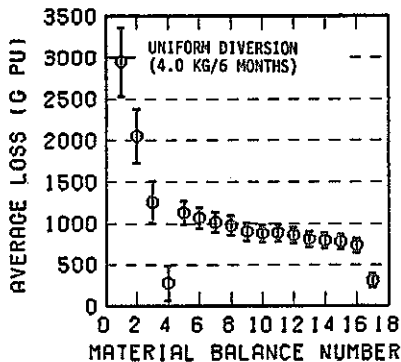
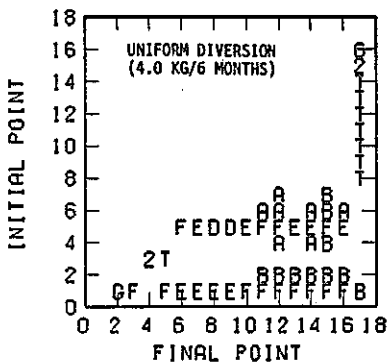
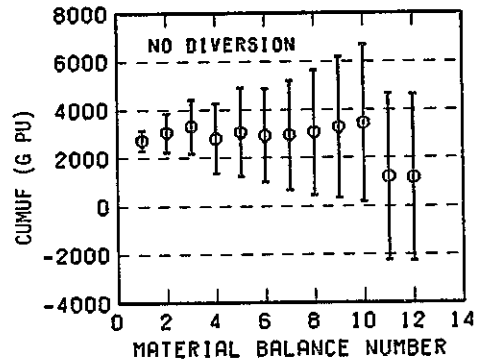
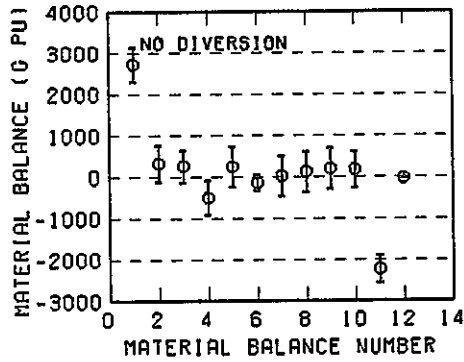

Fig. 5.38

Comparison of detection sensitivities in terms of different in-process PIT models for S.S.1-8 (uniform diversion of 4.0 kgs Pu per 6 months).



Patial PIT
Excluded
Mixer-settler
Inventory



Full PIT
Estimation
Accuracy of
Mixer-settler
Inventory
= 20%

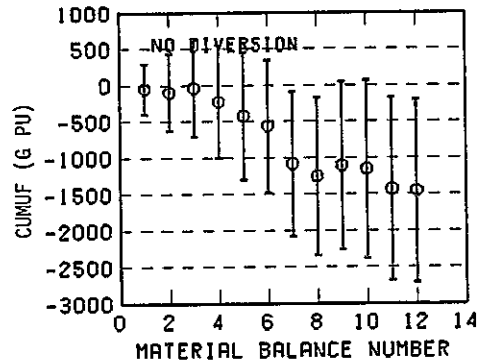
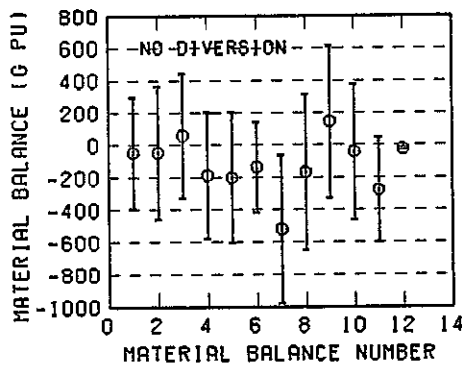

Full PIT
Estimation
Accuracy of
Mixer-settler
Inventory
= 10%

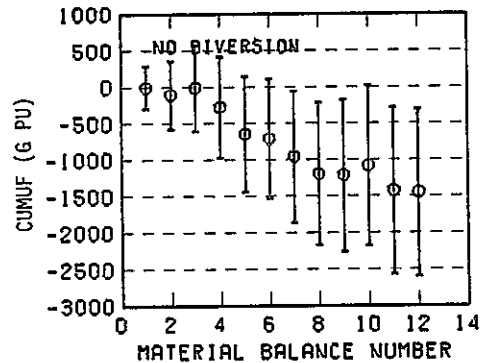
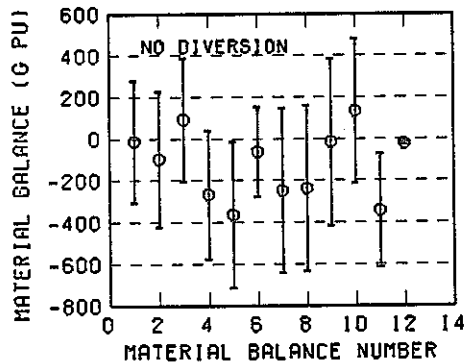

Full PIT
Estimation
Accuracy of
Mixer-Settler
Inventory
= 5%

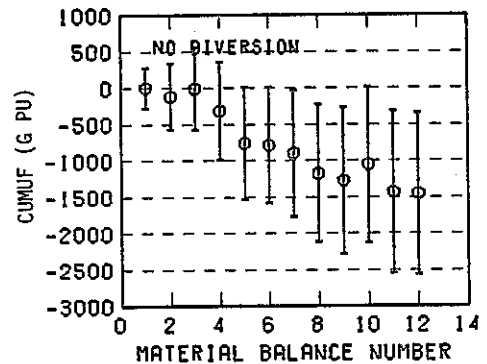
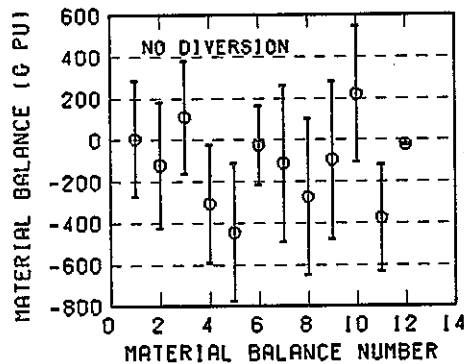
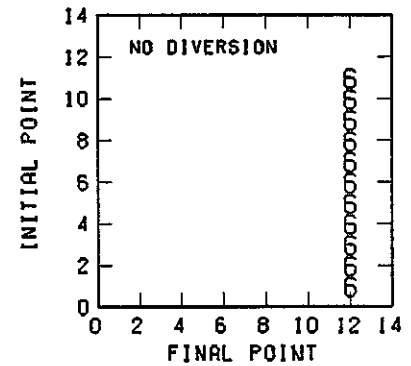
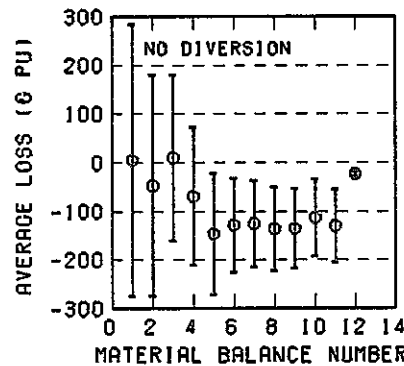
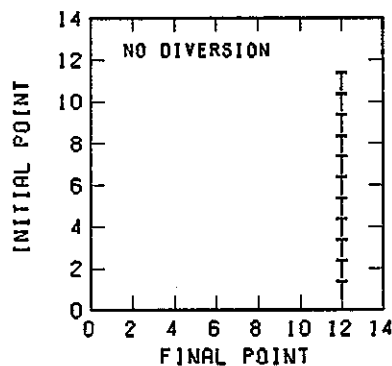
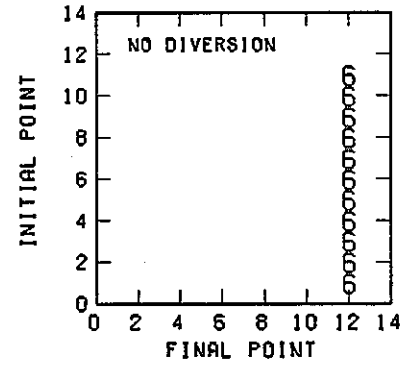
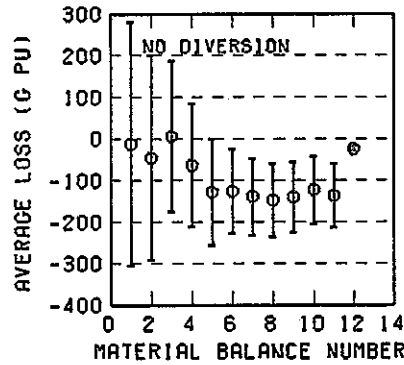
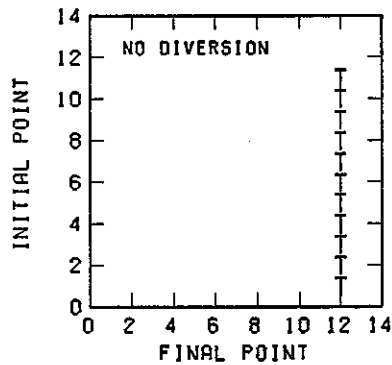
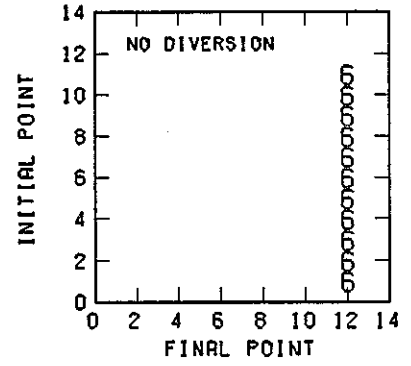
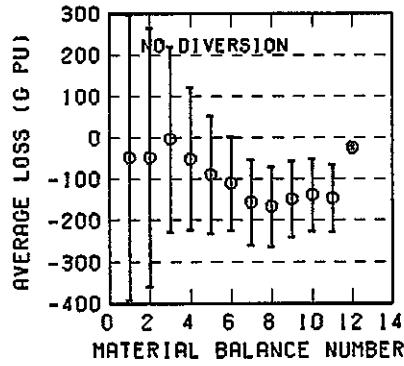
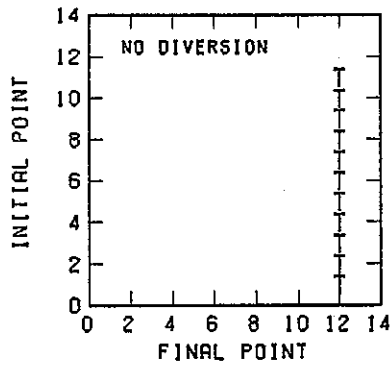
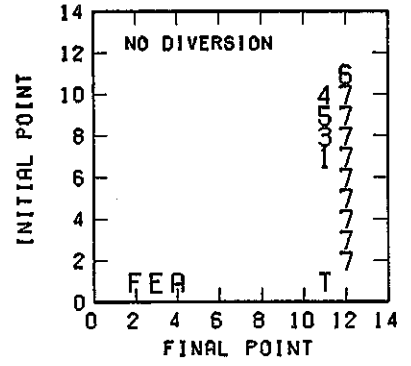
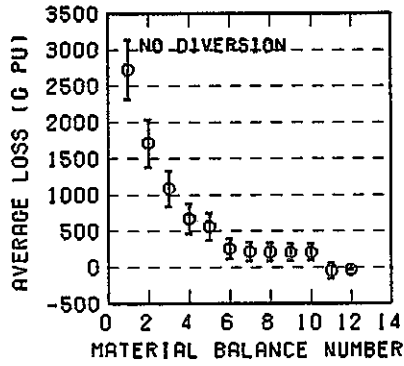
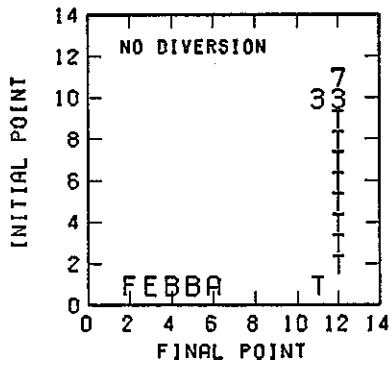
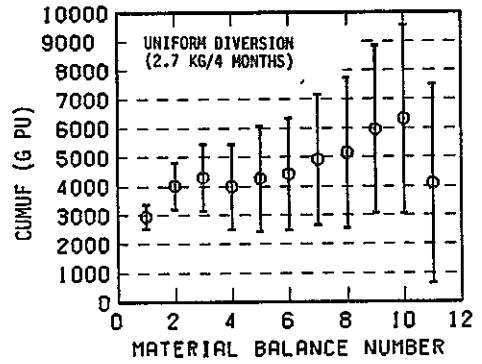
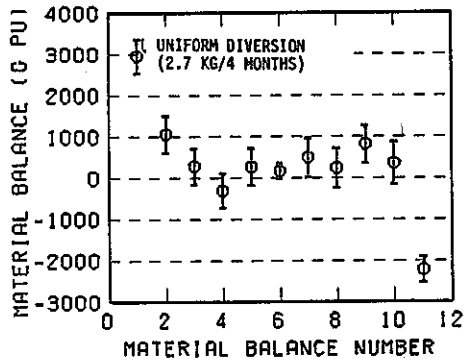

Fig. 5.39

Comparison of detection sensitivities in terms of different in-process PIT models for S.S.1-10 (no diversion).



Patial PIT
Excluded
Mixer-settler
Inventory



Full PIT
Estimation
Accuracy of
Mixer-settler
Inventory
= 20%

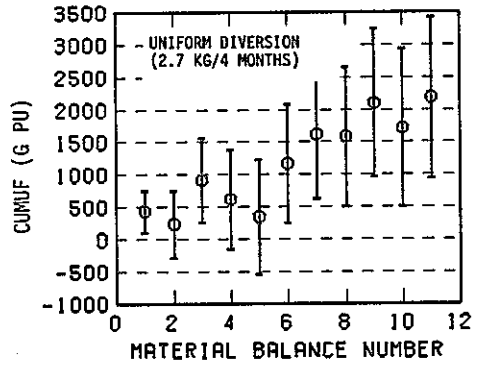
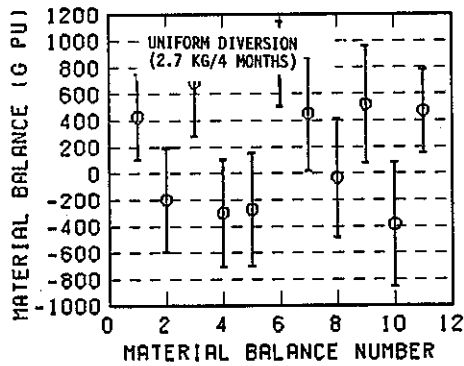

Full PIT
Estimation
Accuracy of
Mixer-settler
Inventory
= 10%

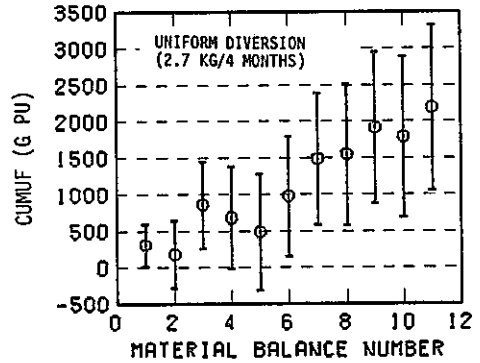
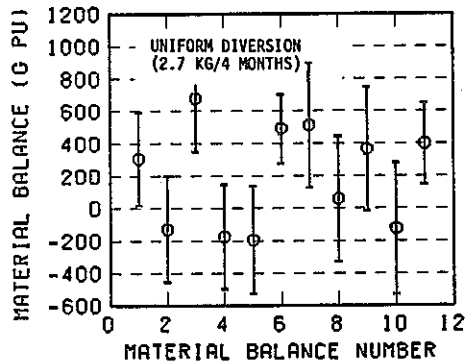

Full PIT
Estimation
Accuracy of
Mixer-Settler
Inventory
= 5%

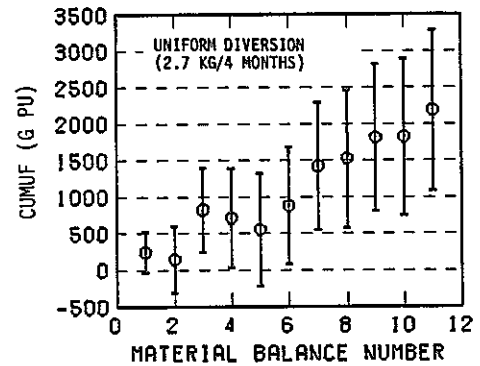
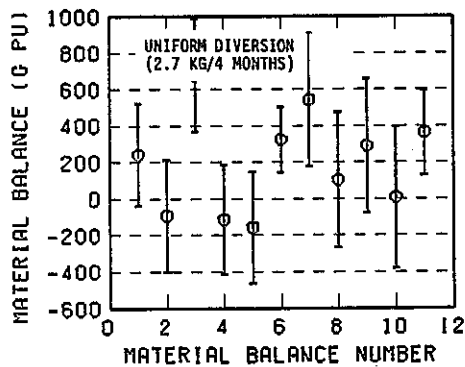
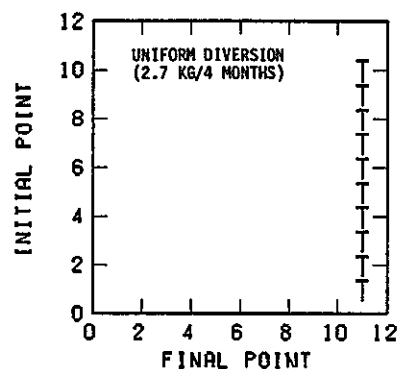
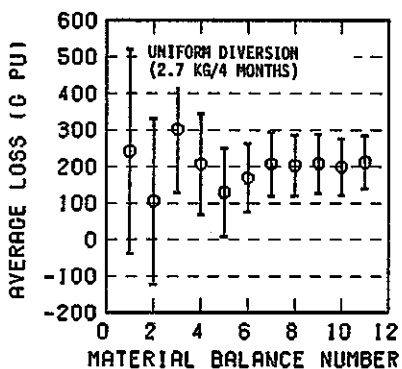
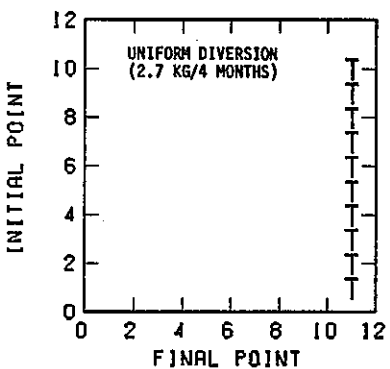
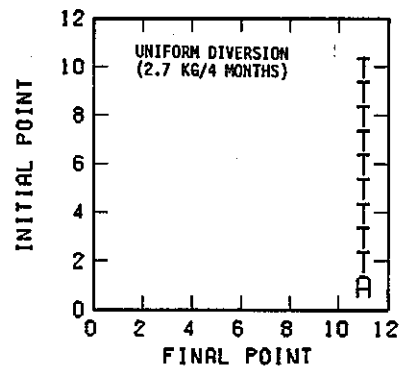
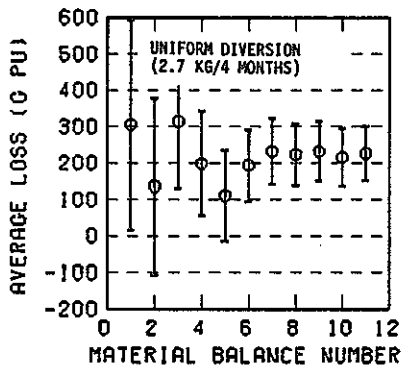
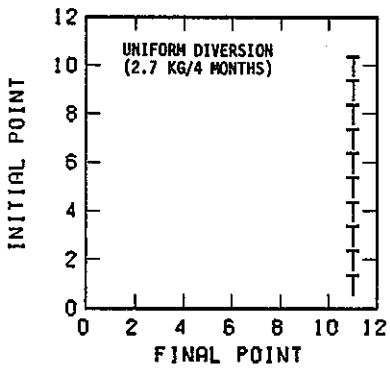
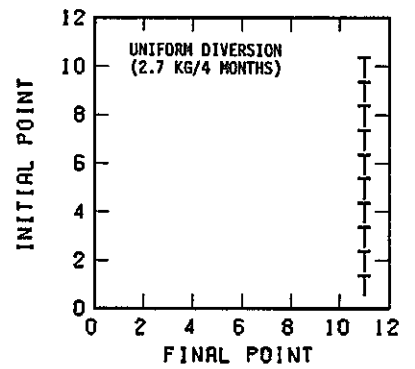
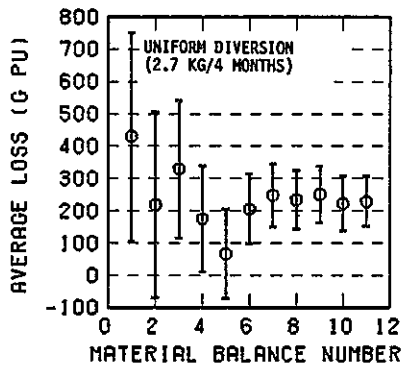
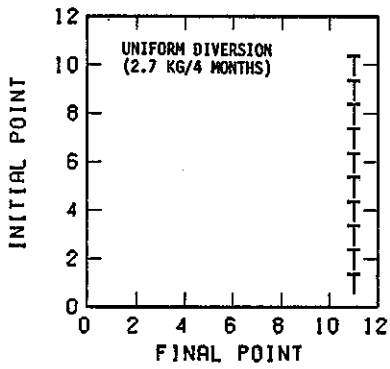
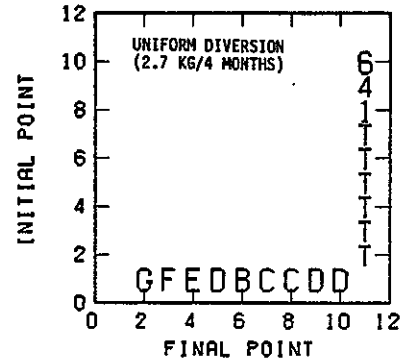
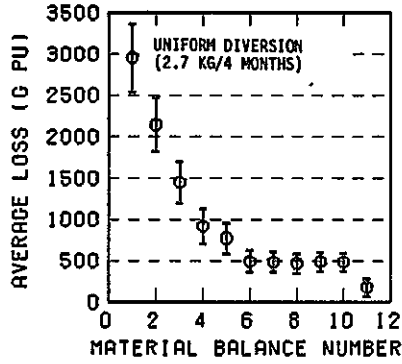
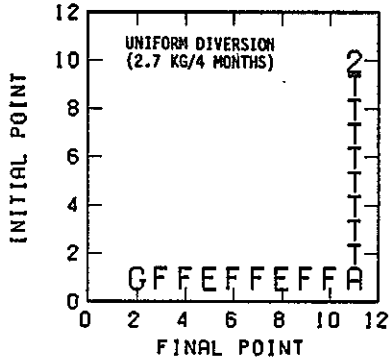
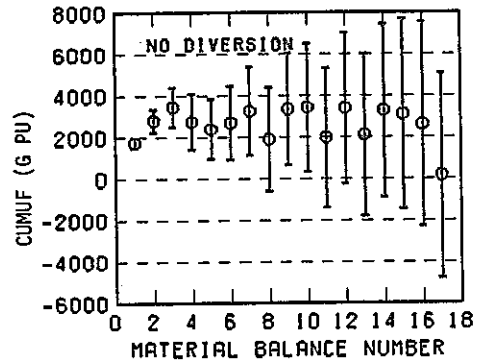
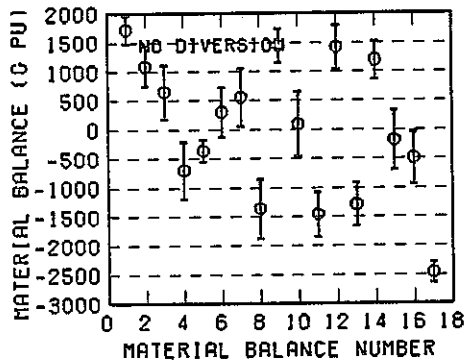

Fig. 5.40 Comparison of detection sensitivities in terms of different in-process PIT models for S.S.1-10 (uniform diversion of 2.7 kgs Pu per 4 months).



Partial PIT
Excluded
Mixer-settler
Inventory



Full PIT
Estimation
Accuracy of
Mixer-settler
Inventory
= 20%

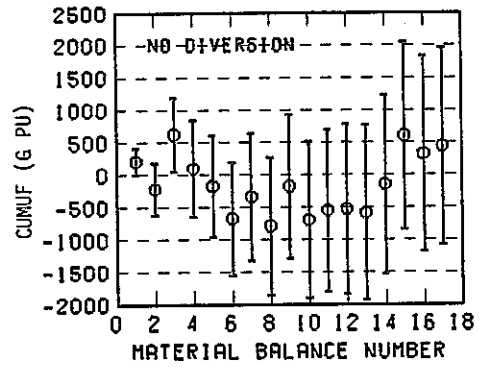
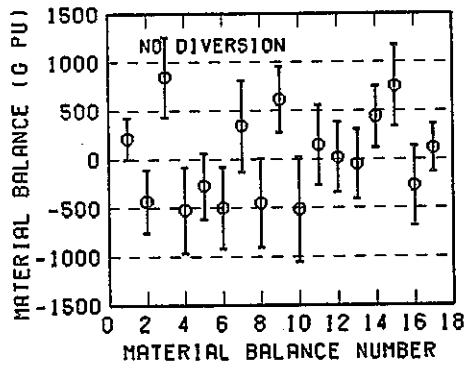

Full PIT
Estimation
Accuracy of
Mixer-settler
Inventory
= 10%

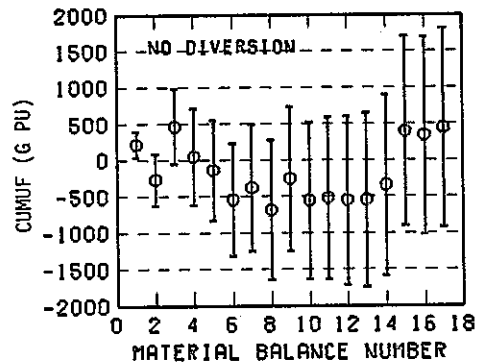
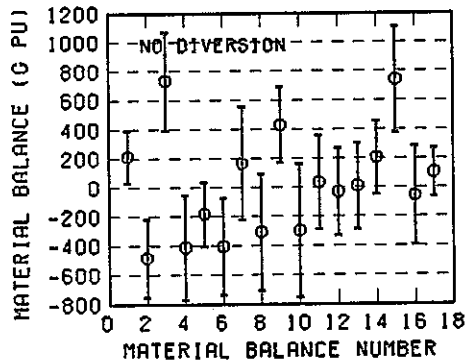

Full PIT
Estimation
Accuracy of
Mixer-settler
Inventory
= 5%

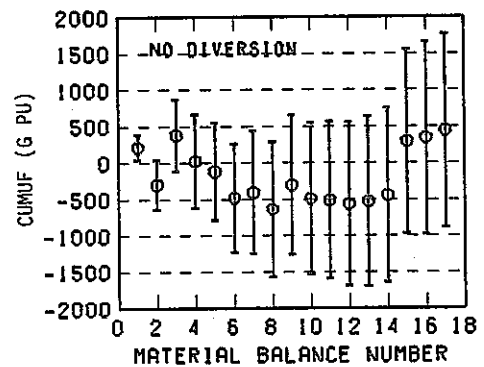
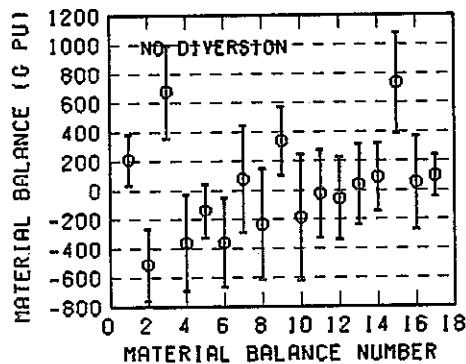
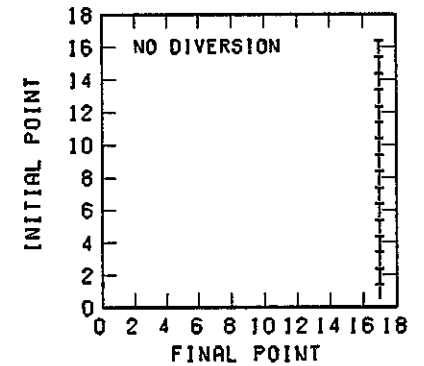
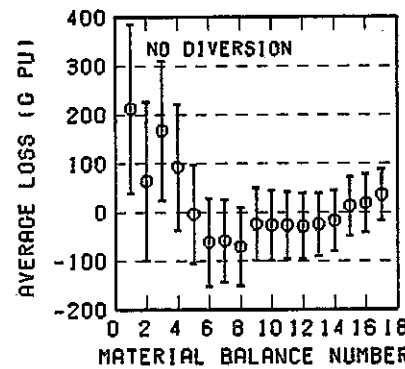
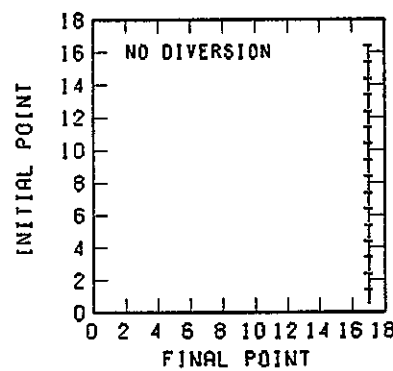
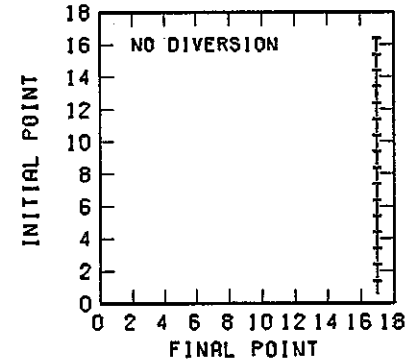
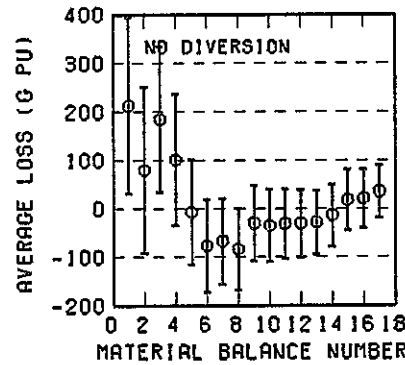
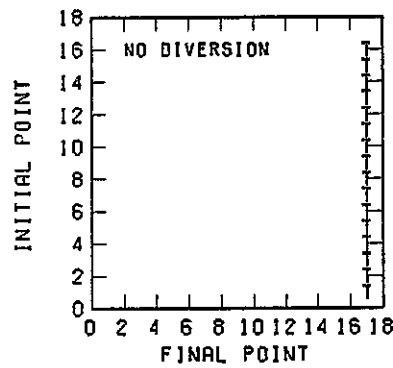
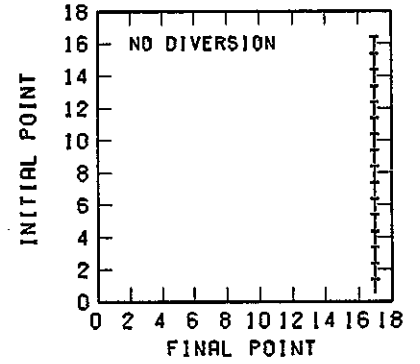
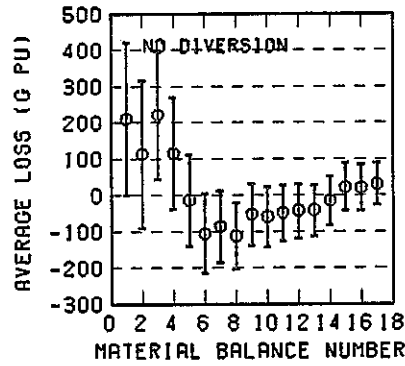
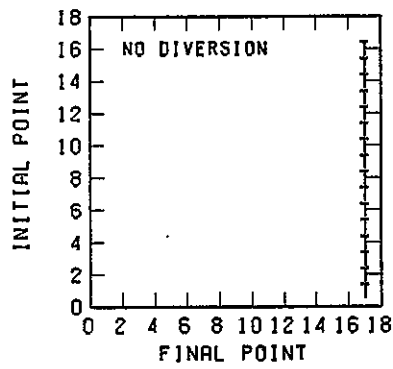
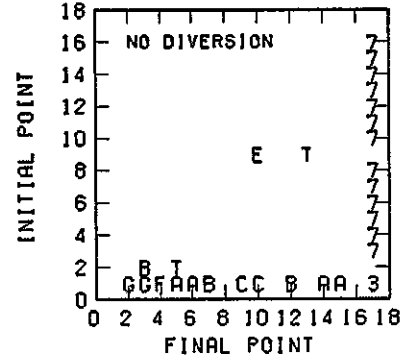
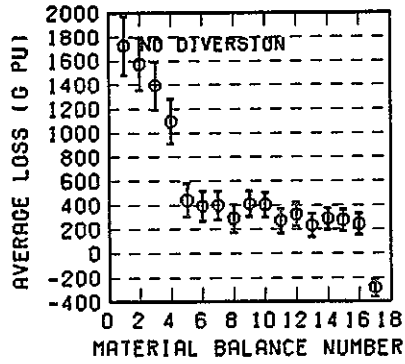
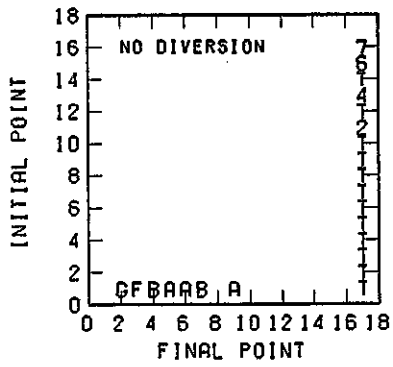
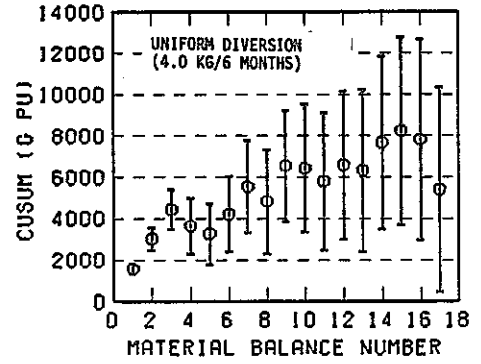
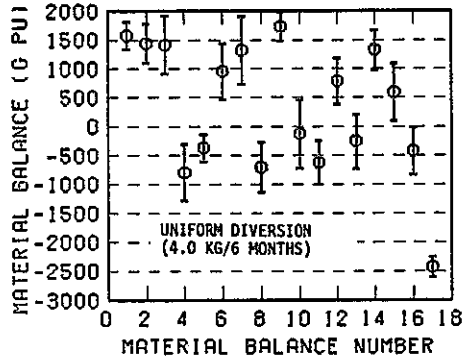

Fig. 5.41 Comparison of detection sensitivities in terms of different in-process PIT models for S.S.4 (no diversion).



Partial PIT
Excluded
Mixer-settler
Inventory



Full PIT
Estimation
Accuracy of
Mixer-settler
Inventory
= 20%

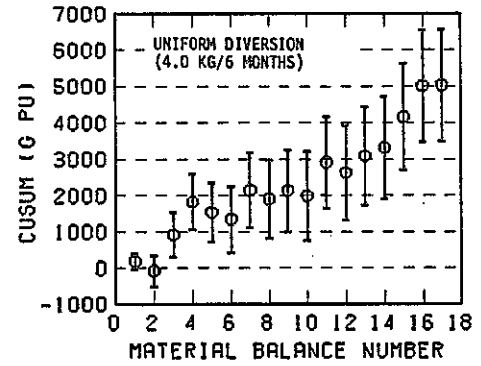
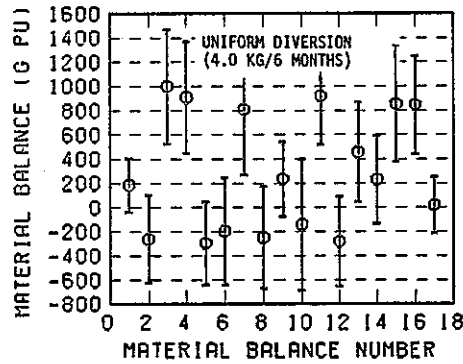

Full PIT
Estimation
Accuracy of
Mixer-settler
Inventory
= 10%

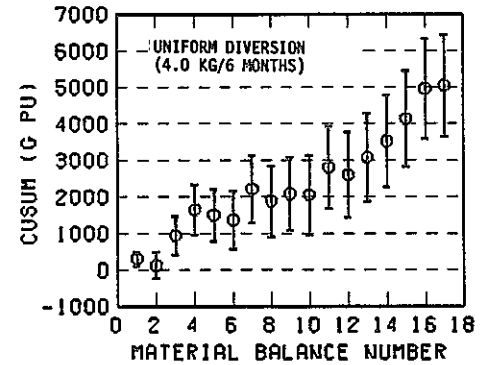
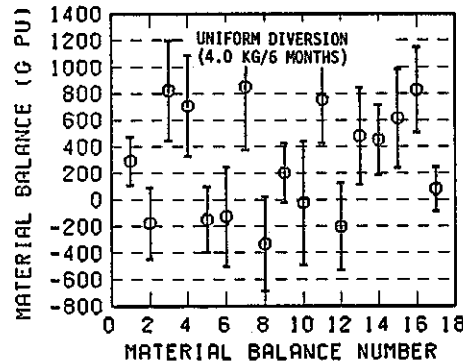

Full PIT
Estimation
Accuracy of
Mixer-settler
Inventory
= 5%

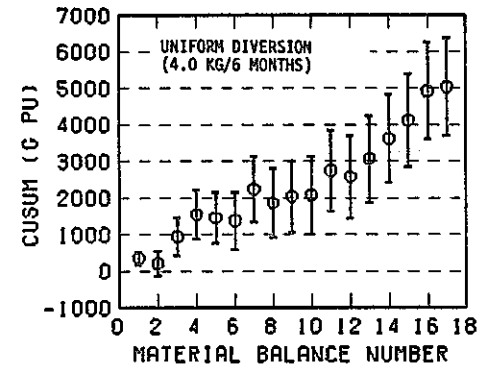
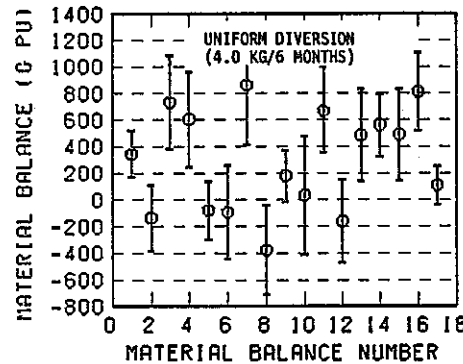
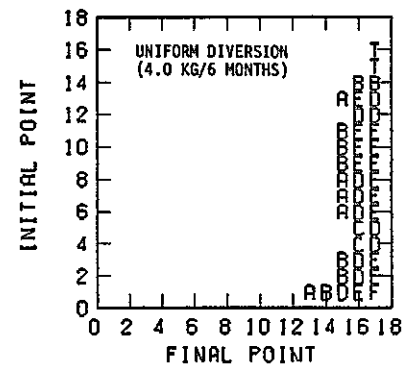
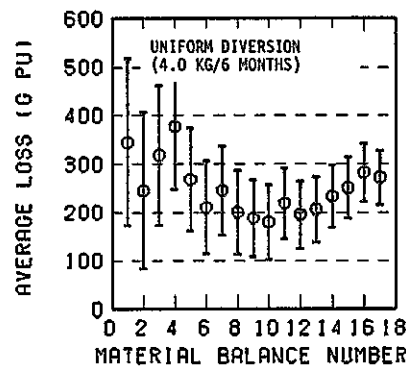
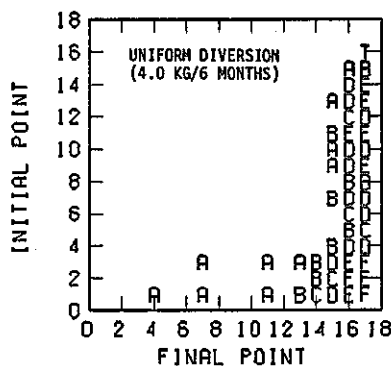
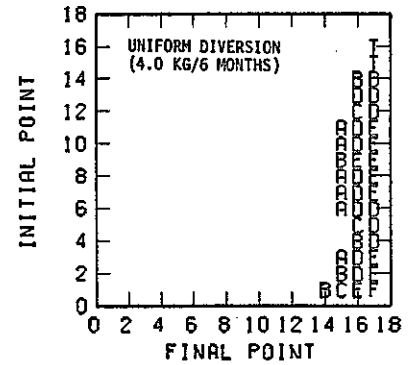
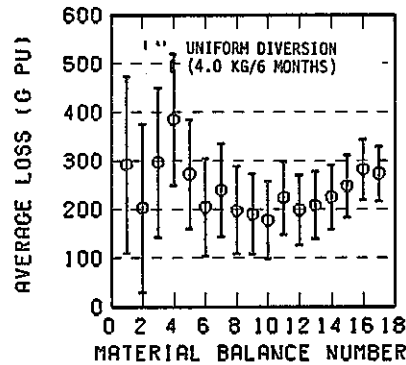
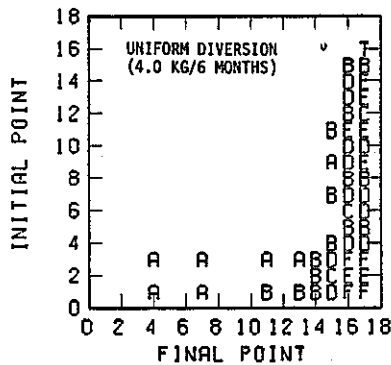
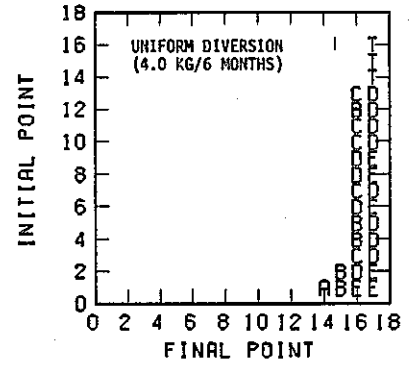
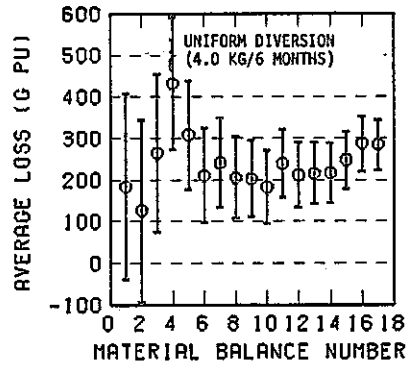
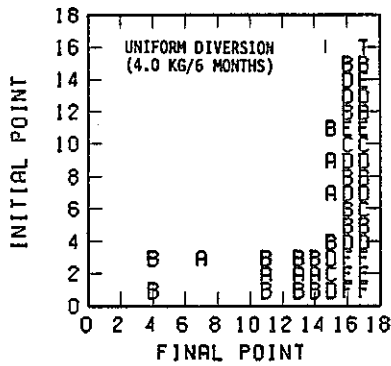
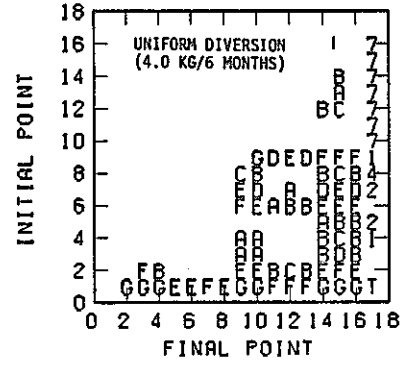
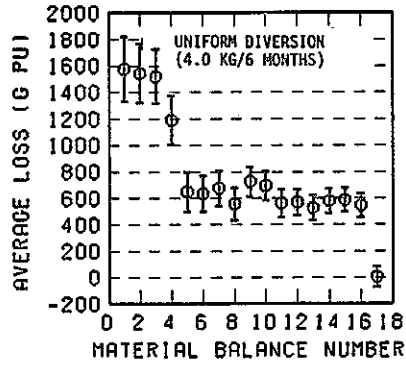
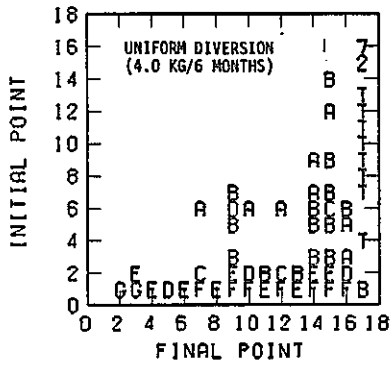

Fig. 5.42

Comparison of detection sensitivities in terms of different in-process PIT models for S.S.4 (uniform diversion of 4.0 kgs Pu per 6 months).



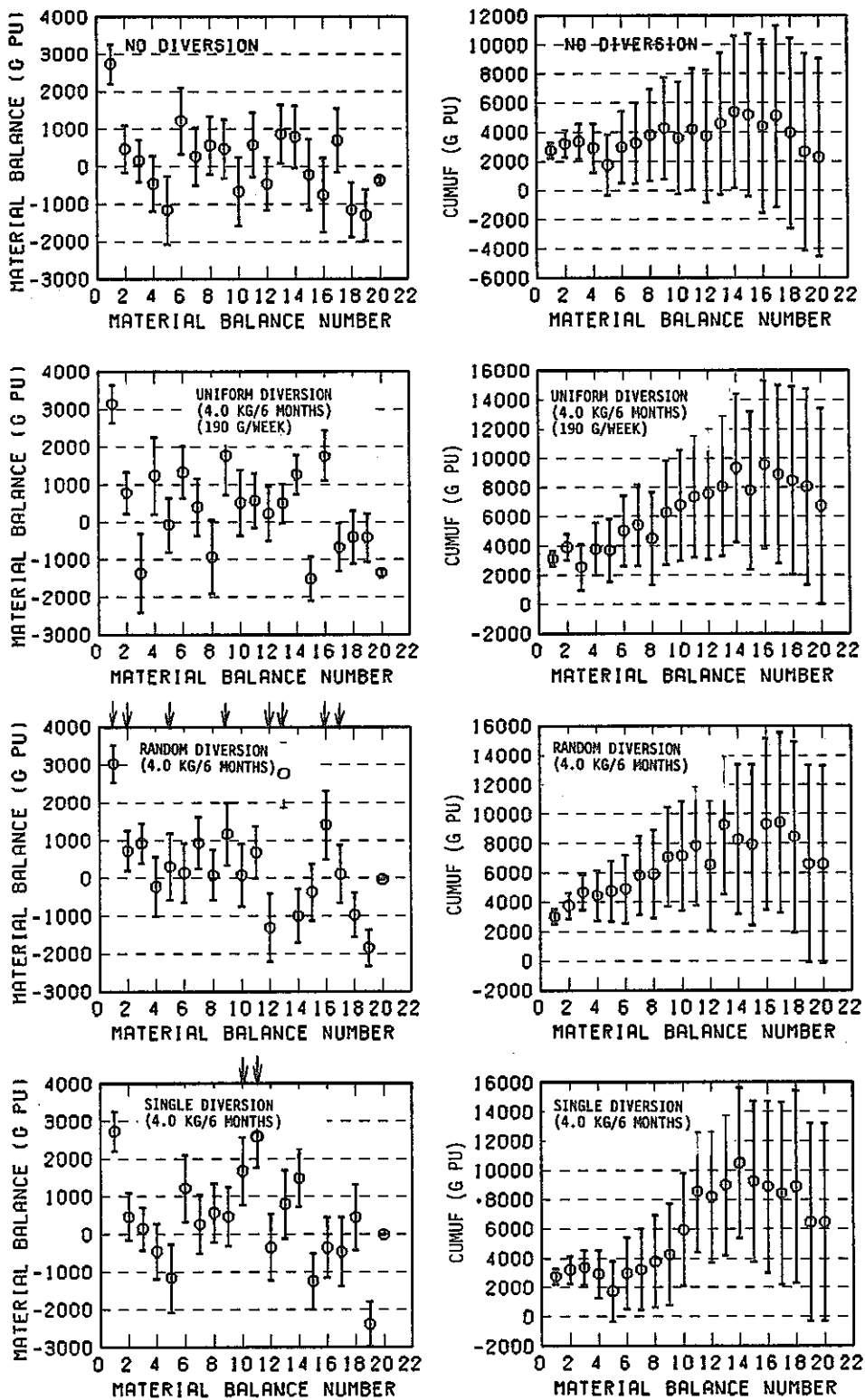
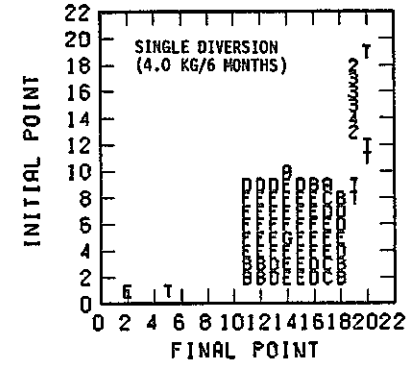
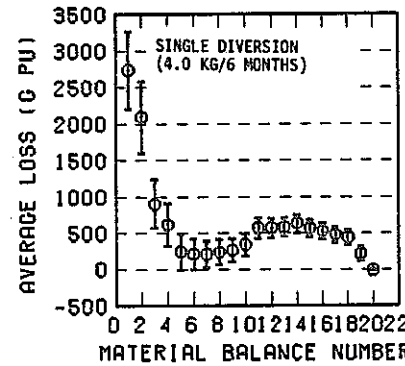
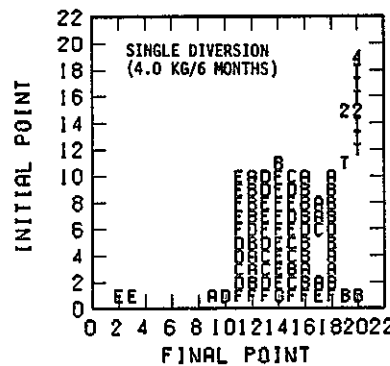
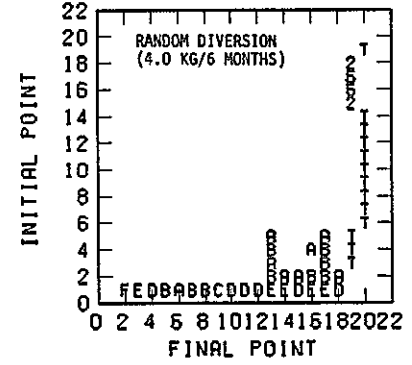
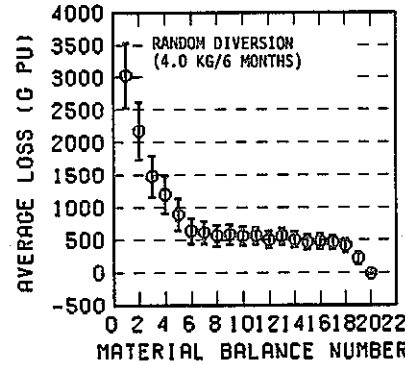
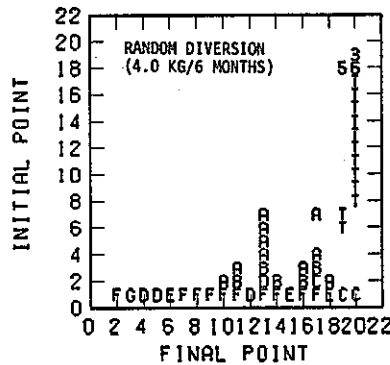
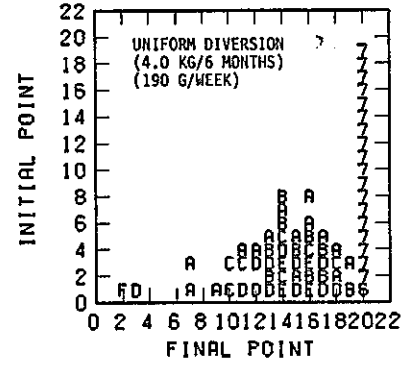
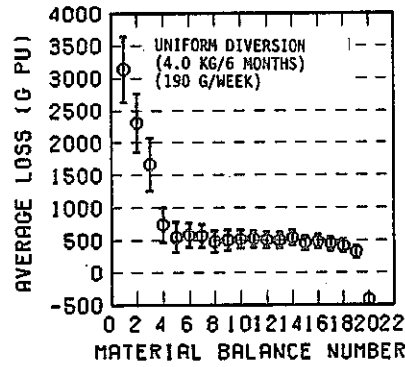
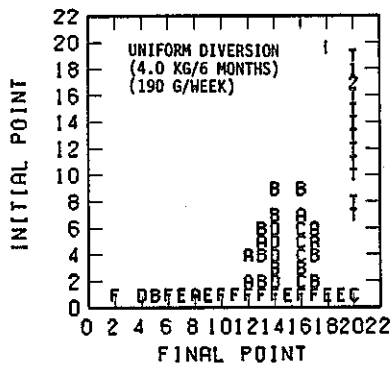
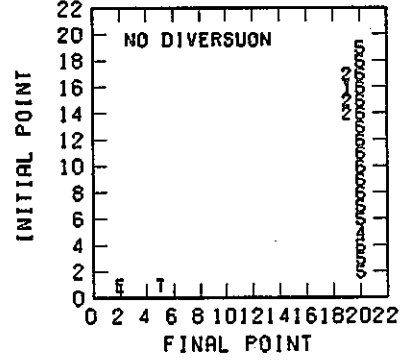
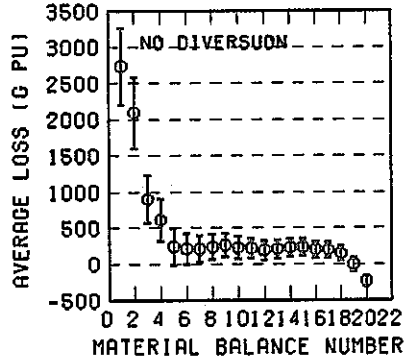
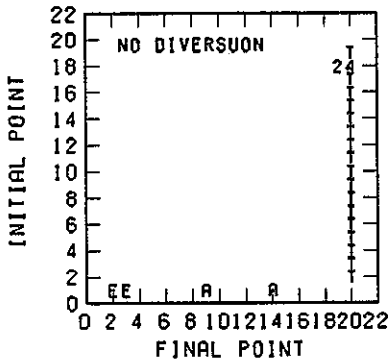

Fig. 5.43 CUMUF and uniform diversion tests for S.S.1-5-1 of different models of diversion (ψ) of 4.0 kgs Pu per TMBP. NDA of 20% accuracy is assumed for n.r.t.a. KMP, D1.



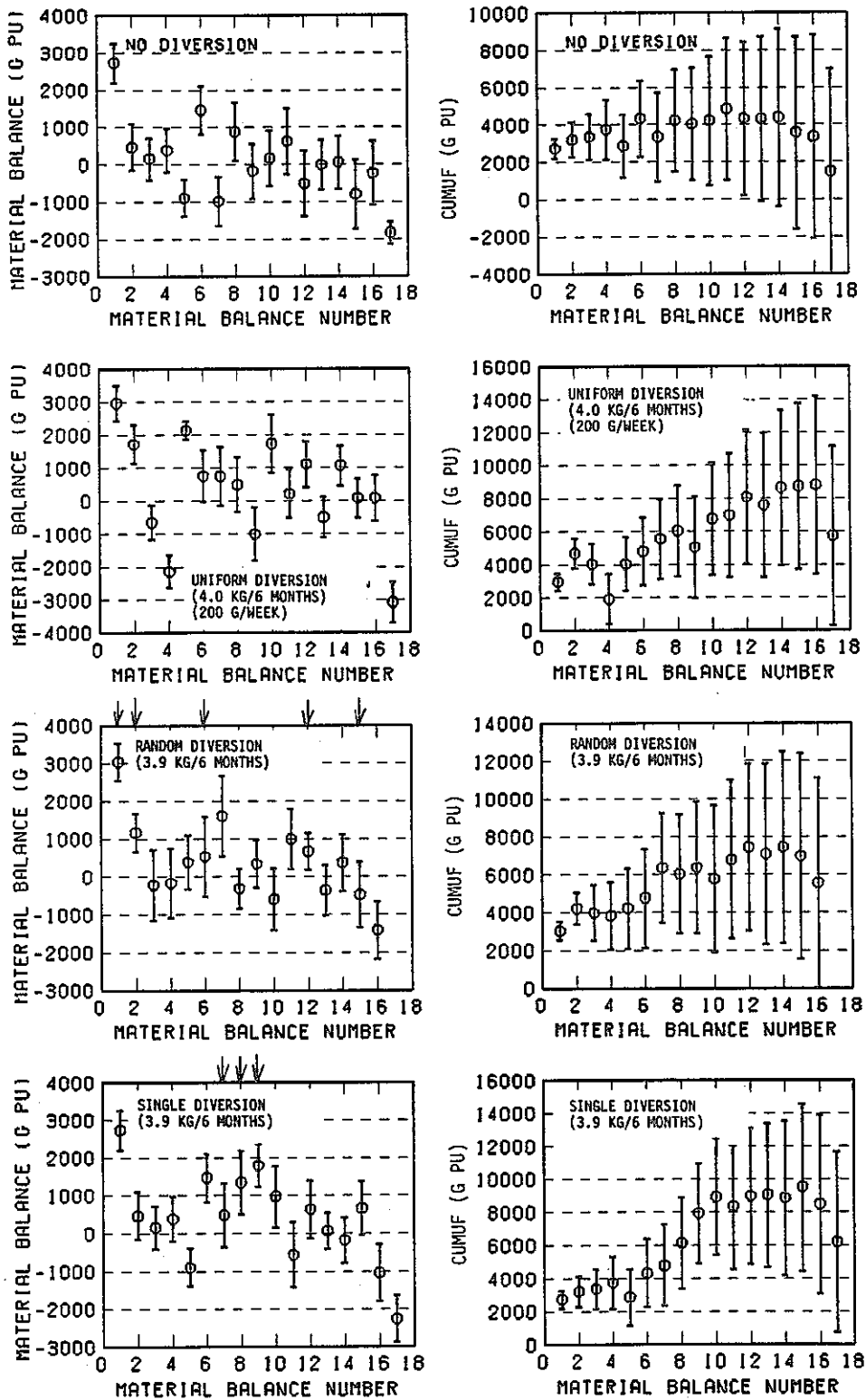
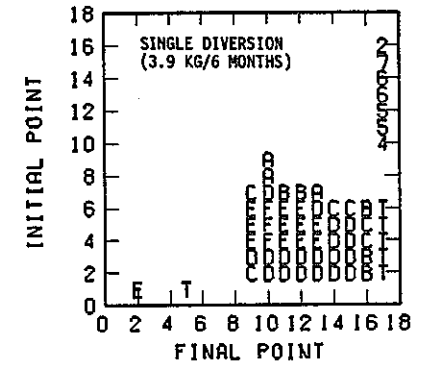
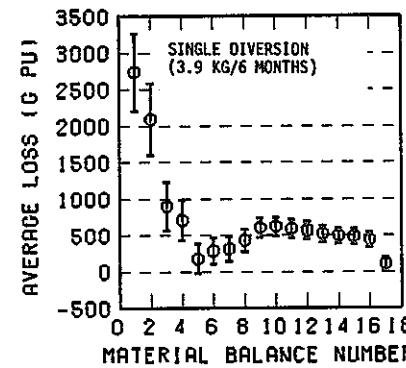
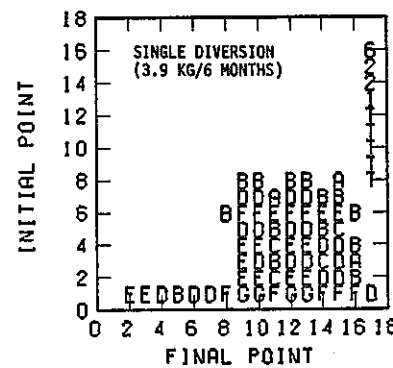
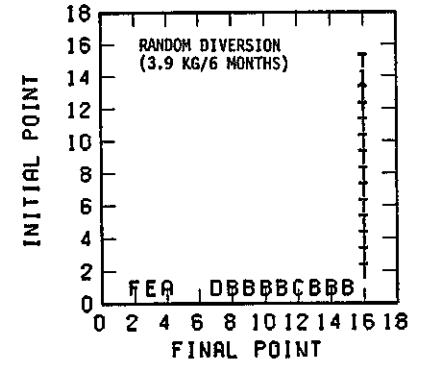
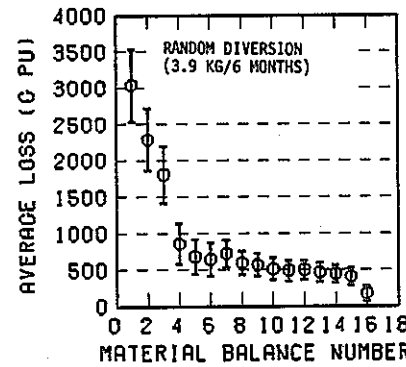
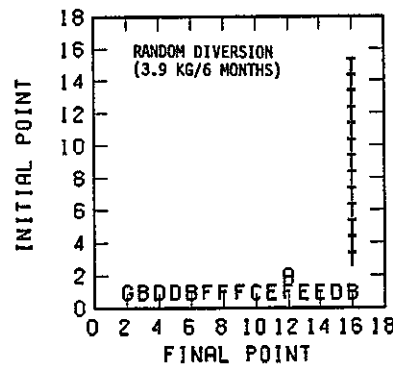
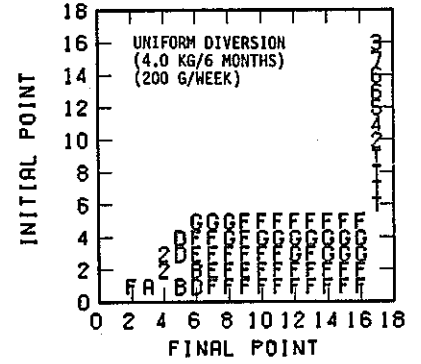
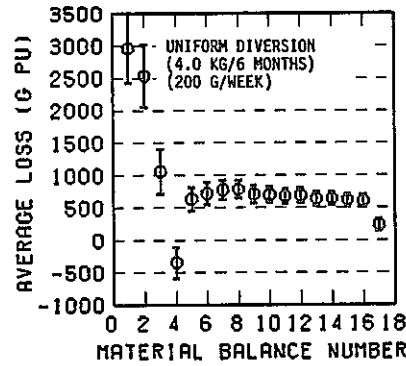
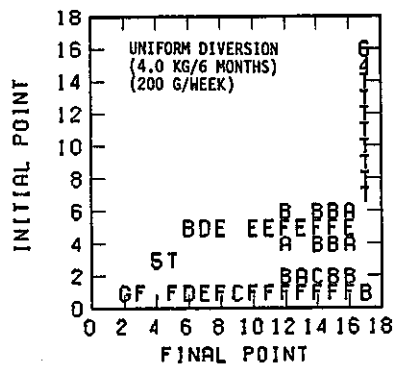
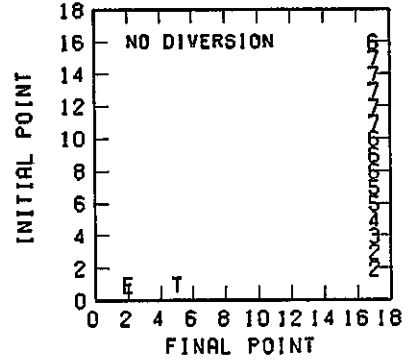
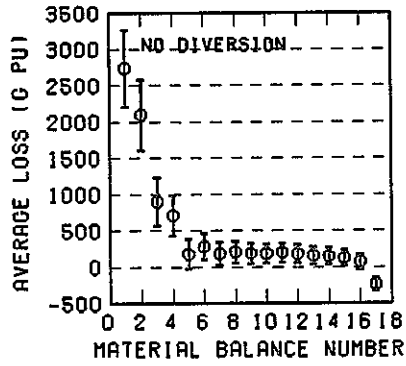
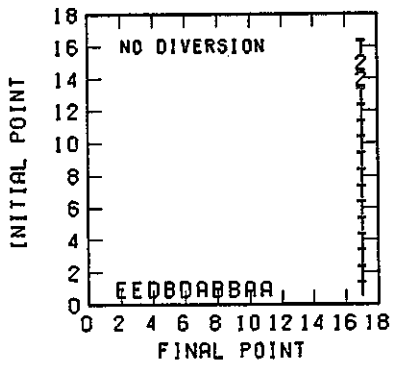

Fig. 5.44 CUMUF and uniform diversion tests for S.S.1-8 of different models of diversion (\downarrow) of 4.0 kgs Pu per TMBP. NDA of 20% accuracy is assumed for n.r.t.a. KMP, D1.



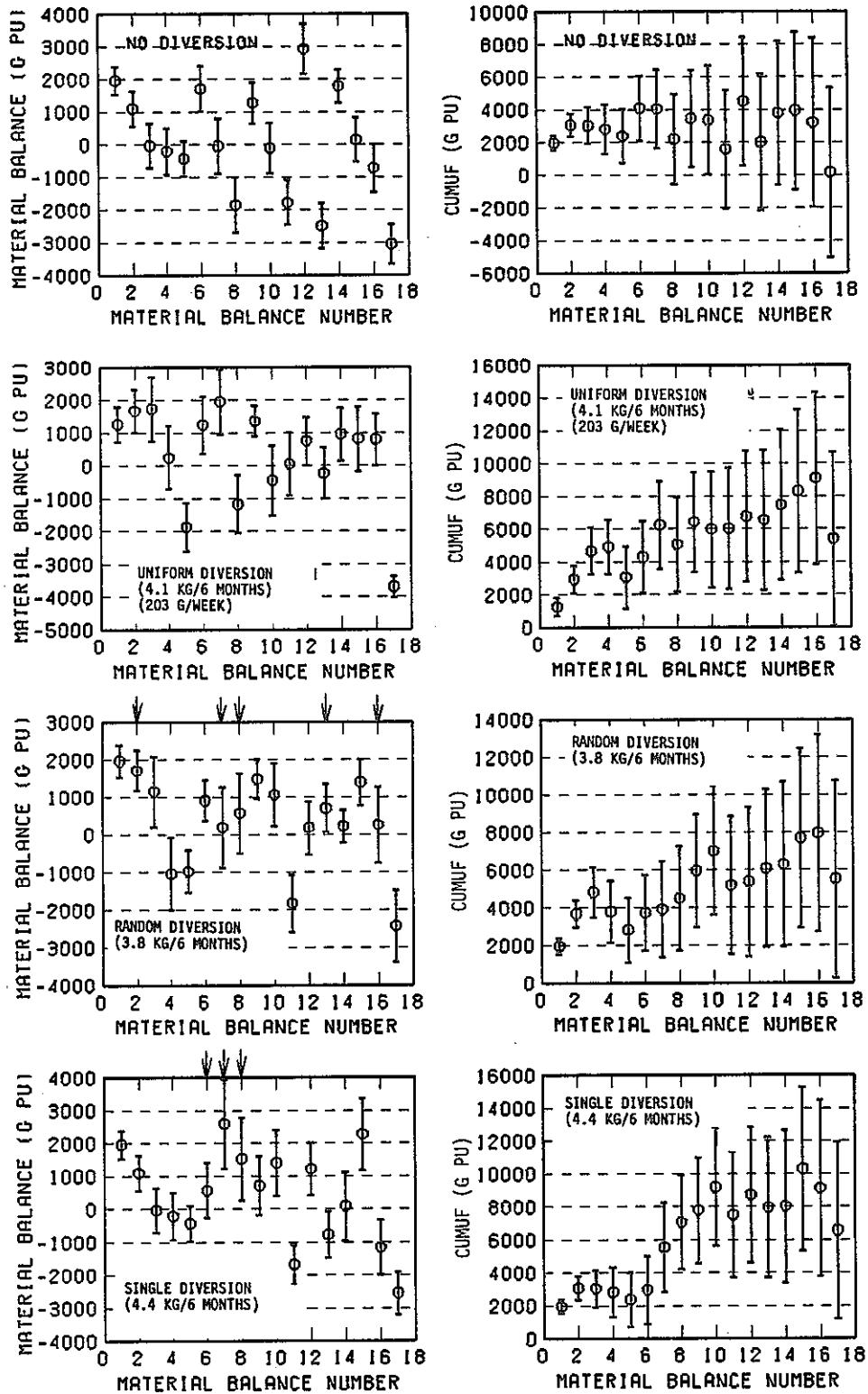
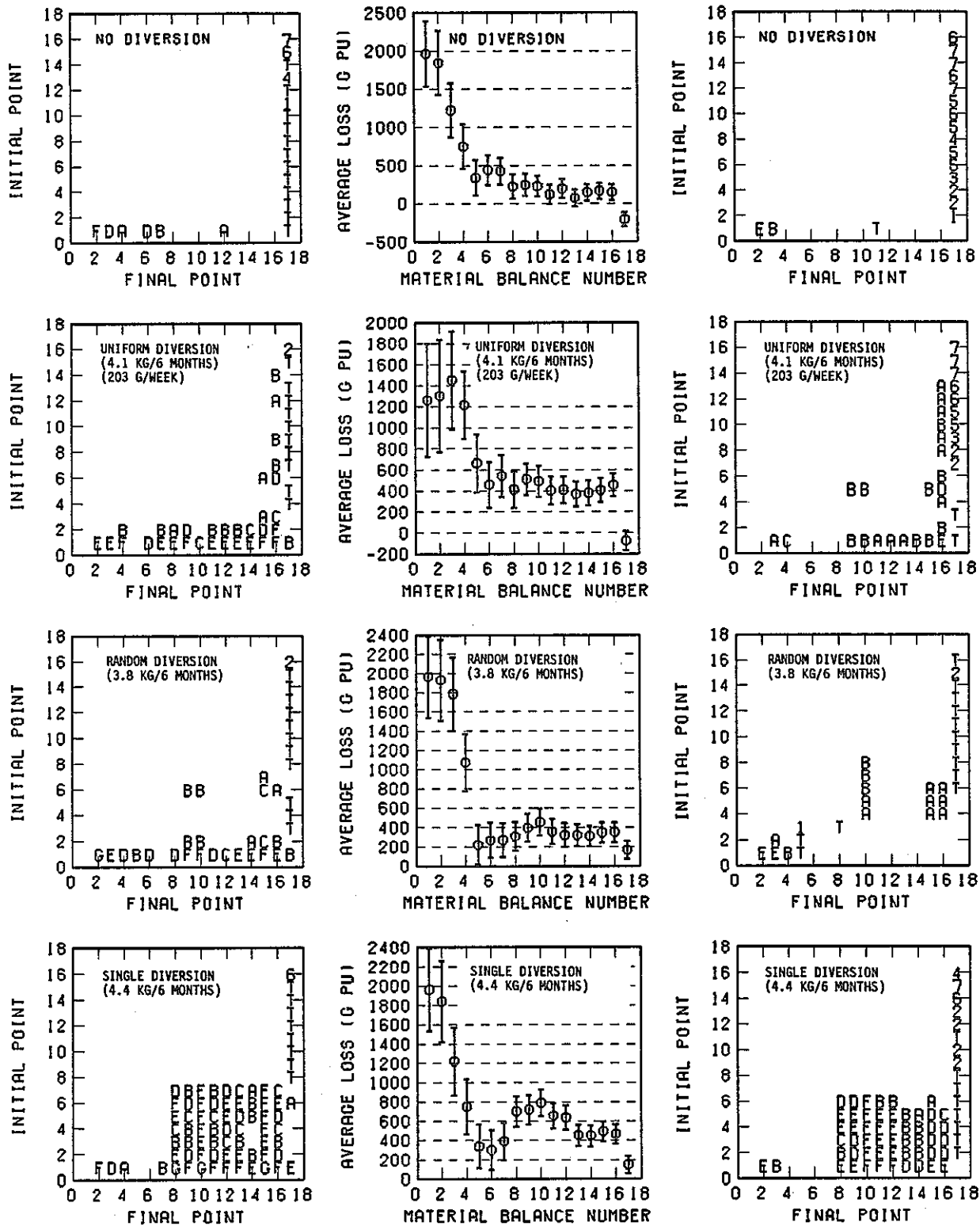

Fig. 5.45 CUMUF and uniform diversion tests for S.S.4 of different models of diversion (∇) of 4.0 kgs Pu per TMBP. NDA of 20% accuracy is assumed for n.r.t.a. KMP, D1.



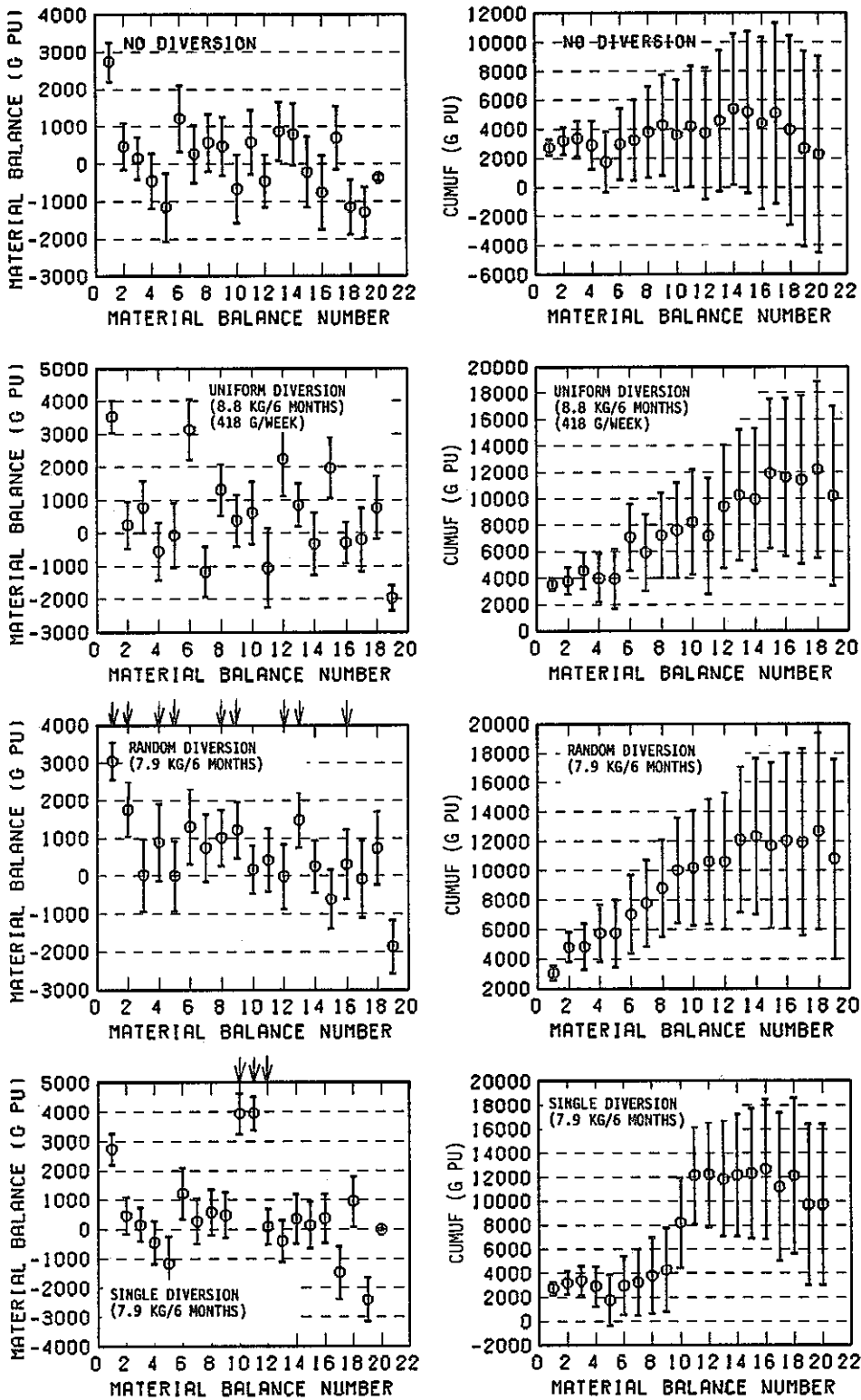
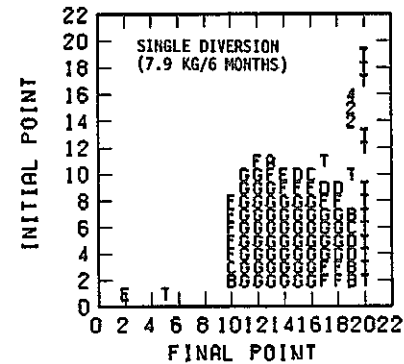
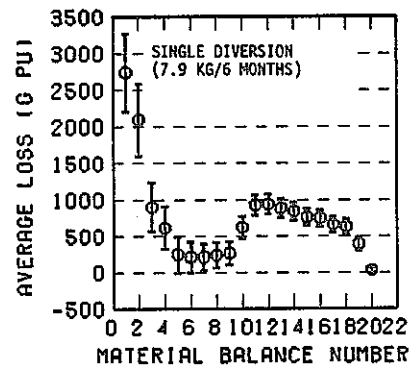
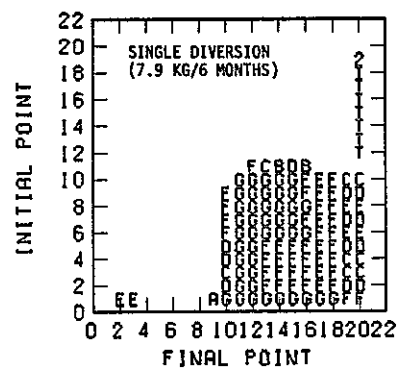
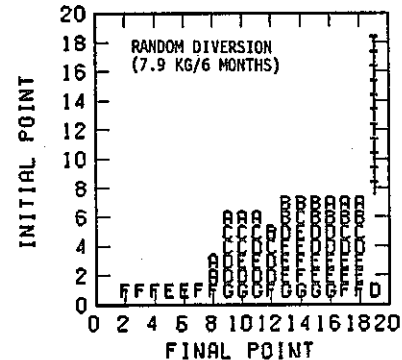
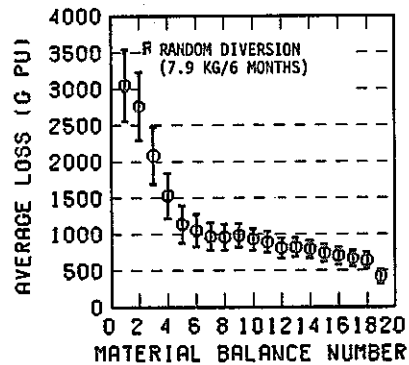
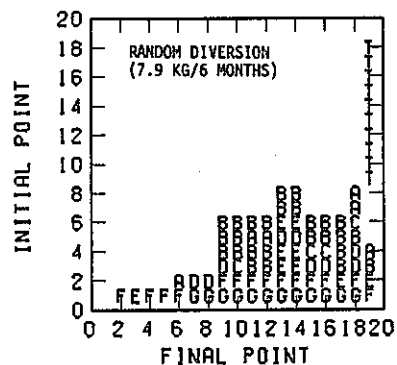
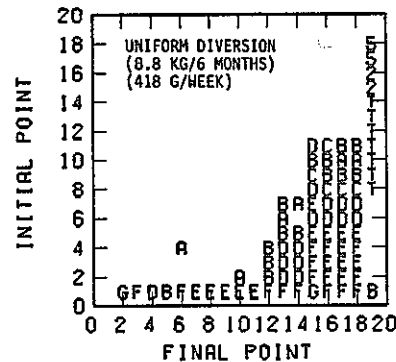
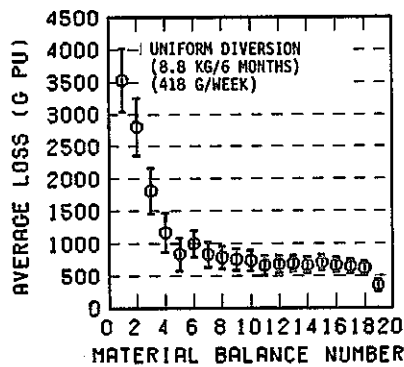
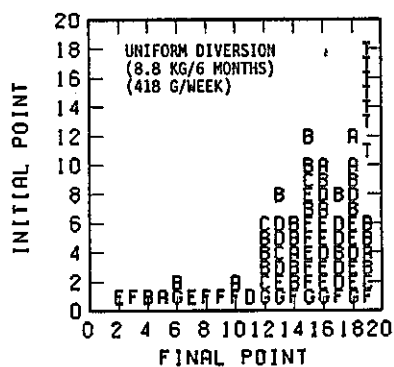
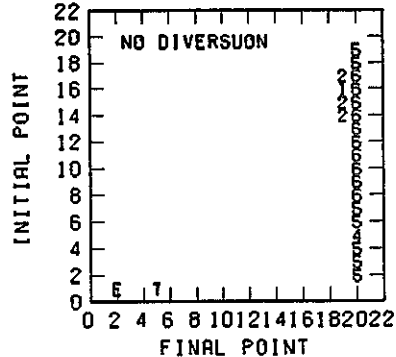
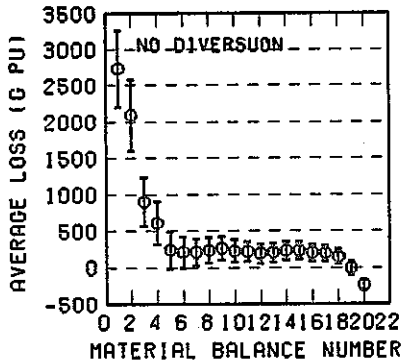
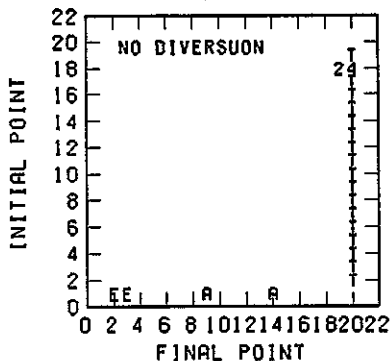

Fig. 5.46 CUMUF and uniform diversion tests for S.S.1-5-1 of different models of diversion (ψ) of 8.0 kgs Pu per TMBP. NDA of 20% accuracy is assumed for n.r.t.a. KMP, D1.



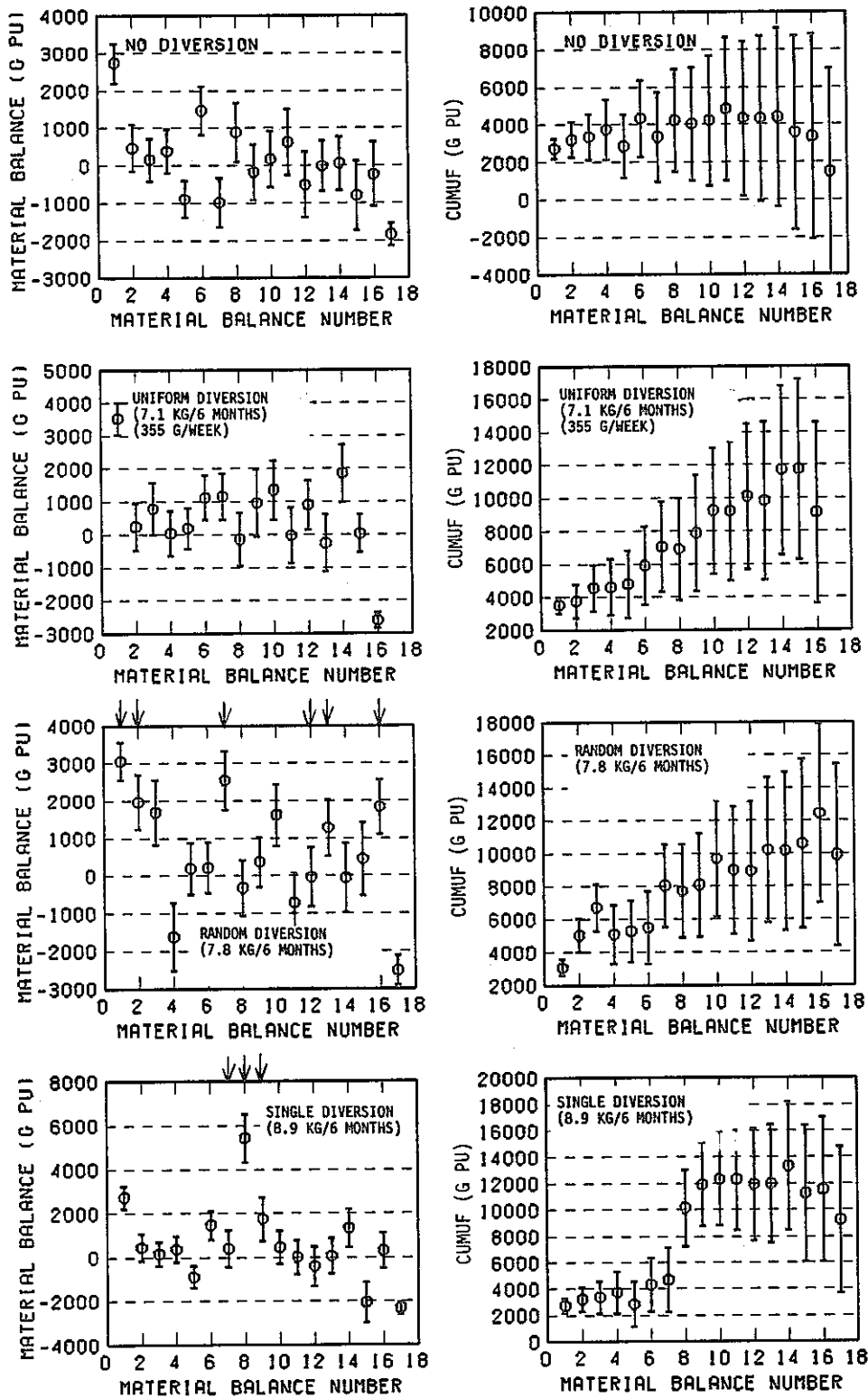
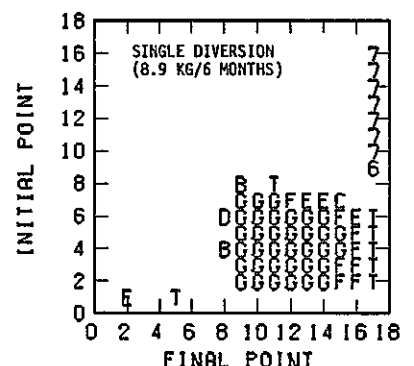
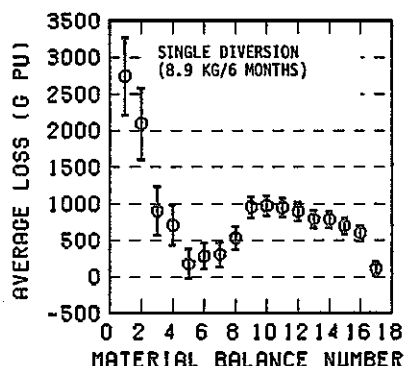
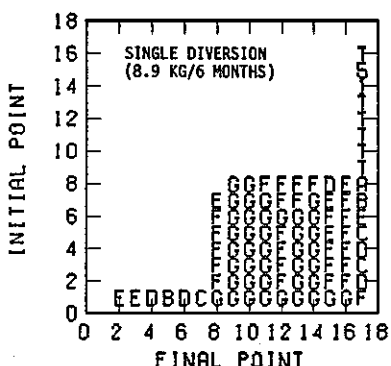
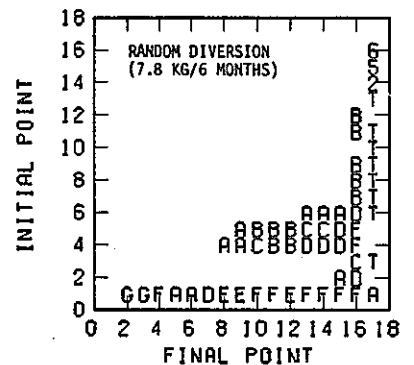
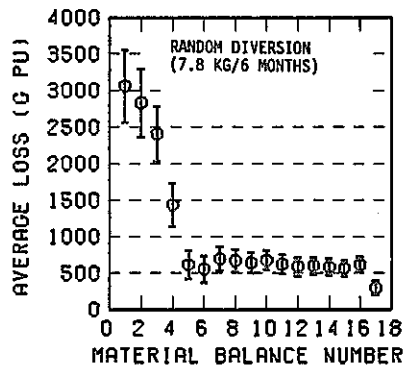
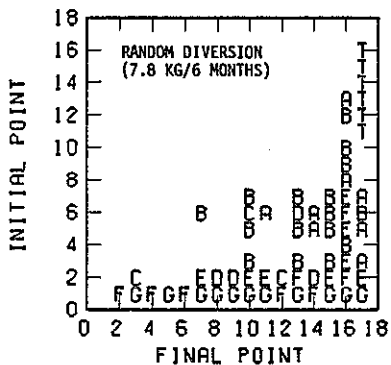
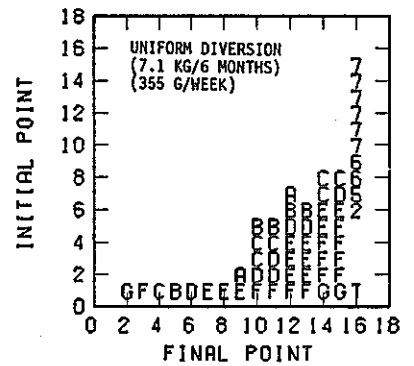
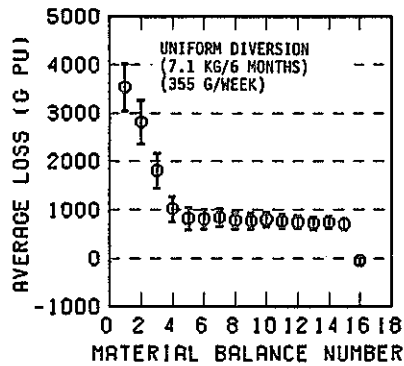
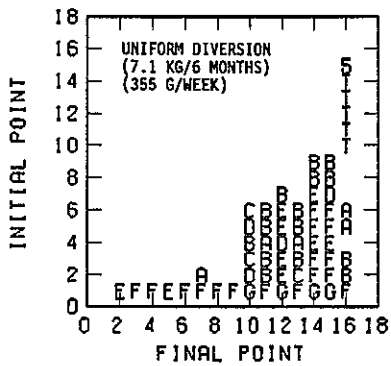
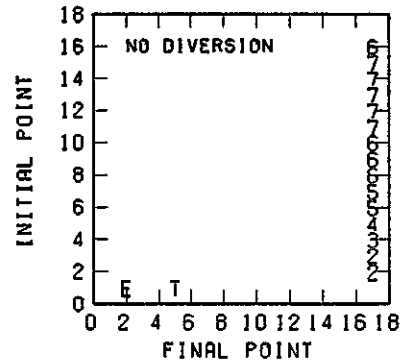
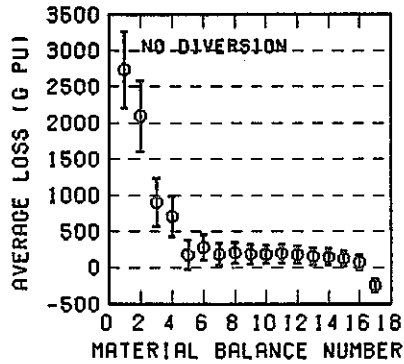
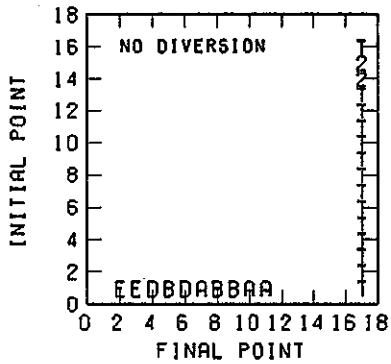

Fig. 5.47 CUMUF and uniform diversion tests for S.S.1-8 of different models of diversion (ψ) of 8.0 kgs Pu per TMBP. NDA of 20% accuracy is assumed for n.r.t.a. KMP, D1.



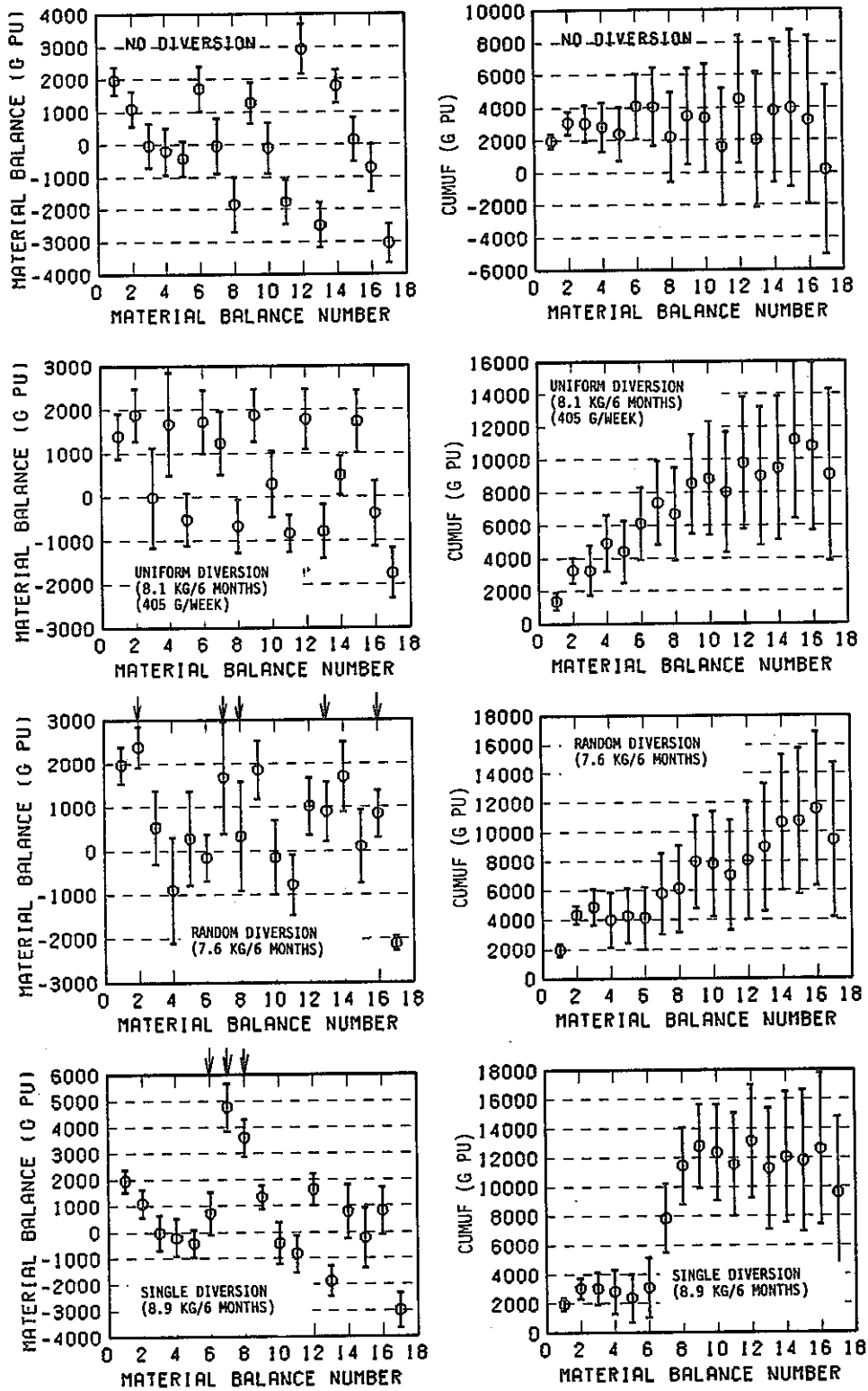
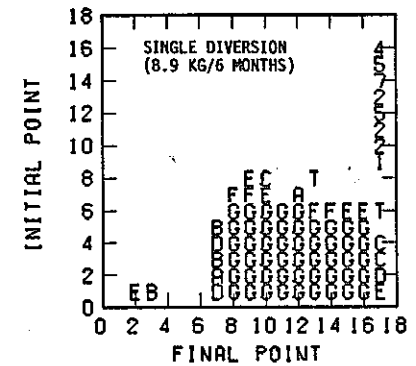
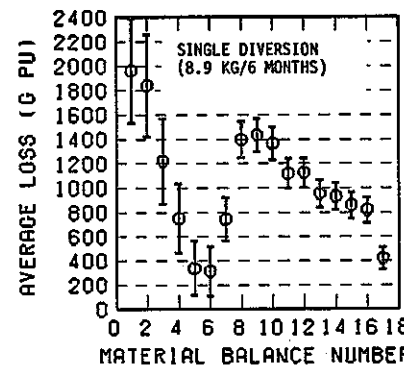
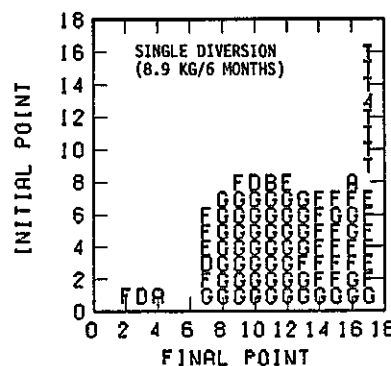
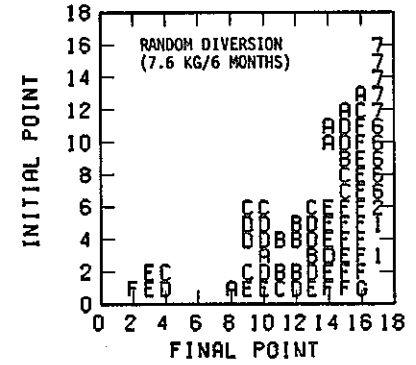
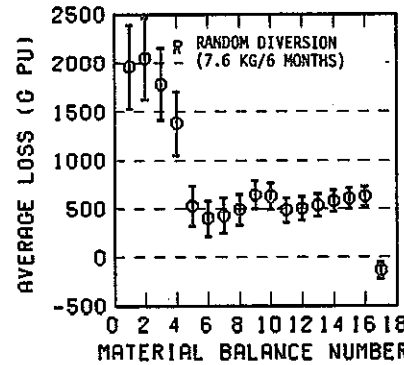
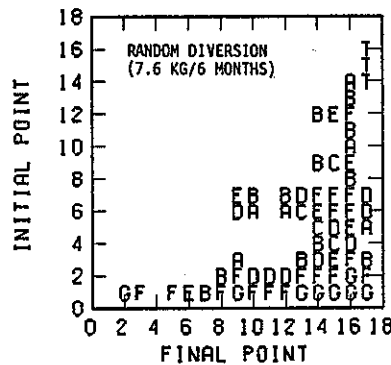
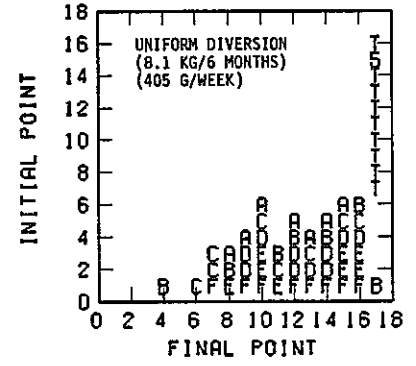
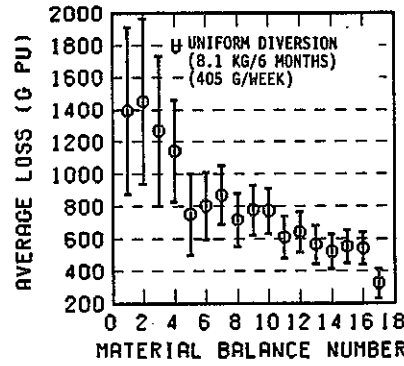
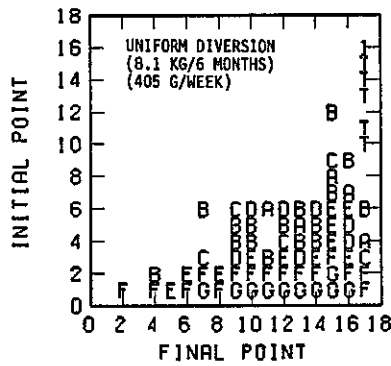
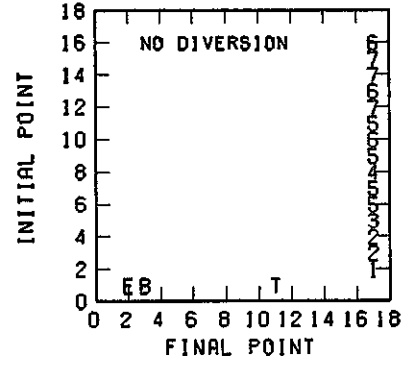
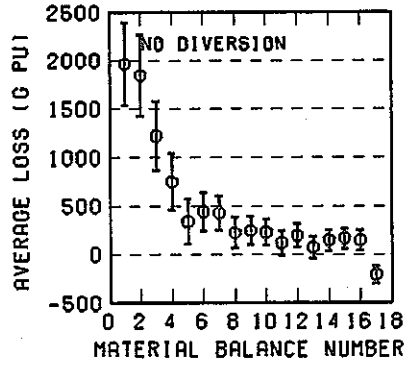
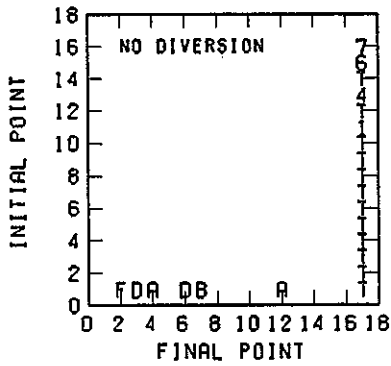
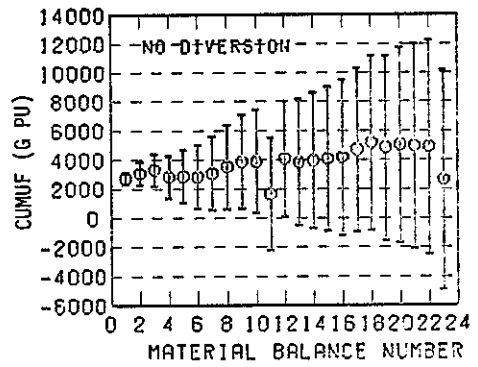
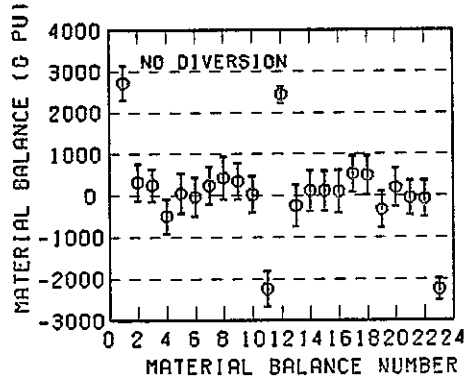

Fig. 5.48 CUMUF and uniform diversion tests for S.S.4 of different models of diversion (\downarrow) of 8.0 kgs Pu per TMBP. NDA of 20% accuracy is assumed for n.r.t.a. KMP, D1.



Partial PIT
Excluded
Mixer-settler
Inventory



Estimated
Unmeasured
Inventories
are First
MUF_d

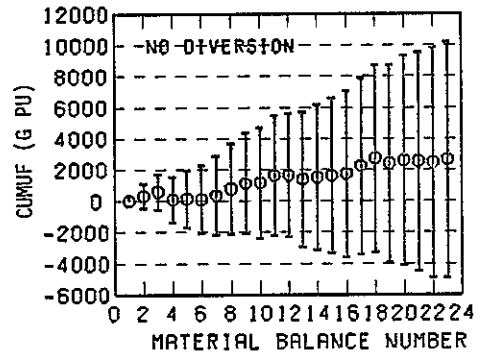
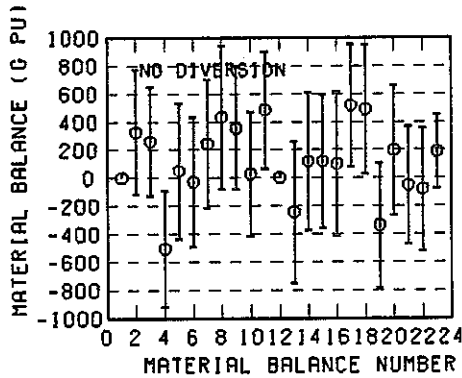

Full PIT
Estimation
Accuracy
of Mixer-
settler
Inventory
is 20%

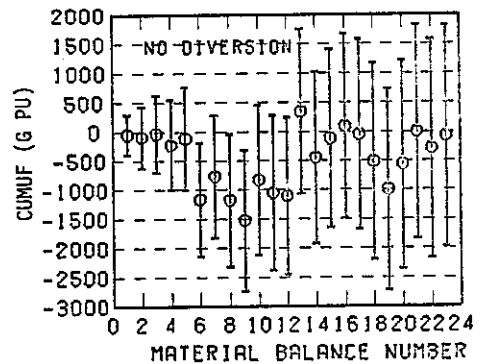
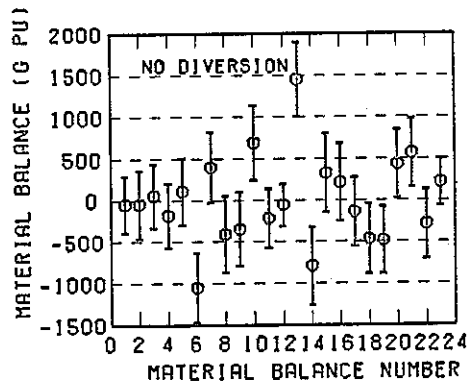
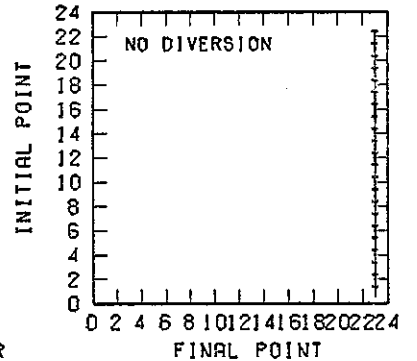
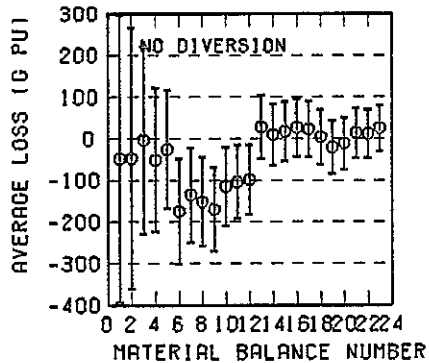
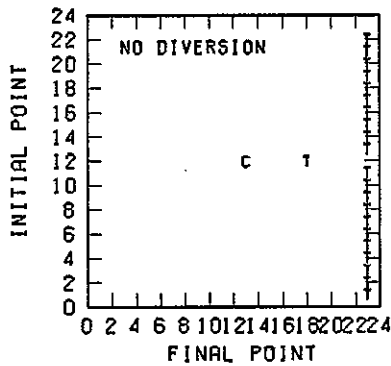
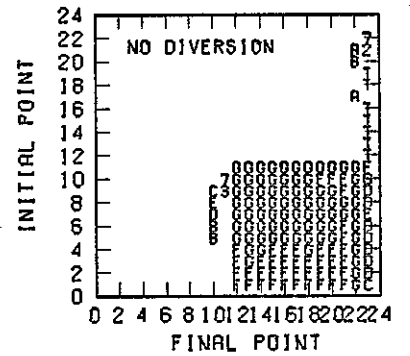
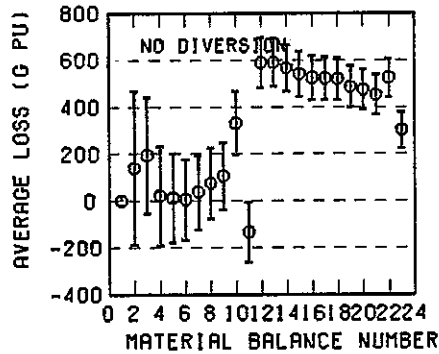
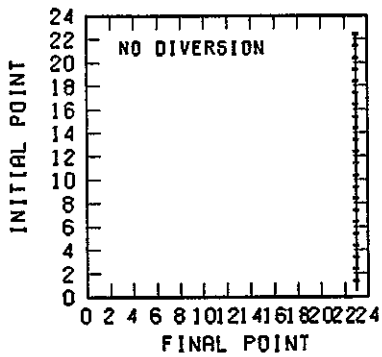
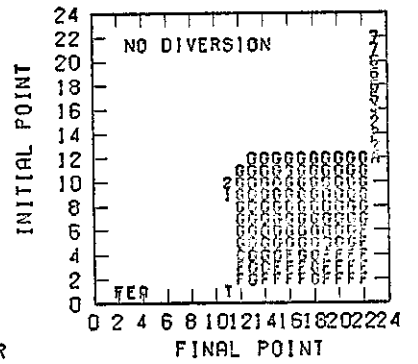
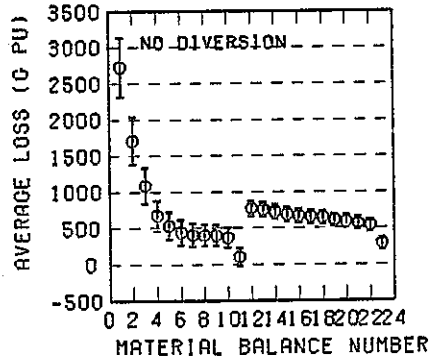
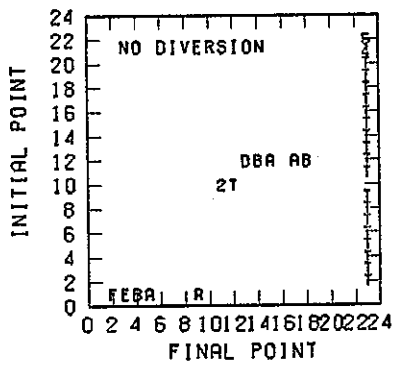
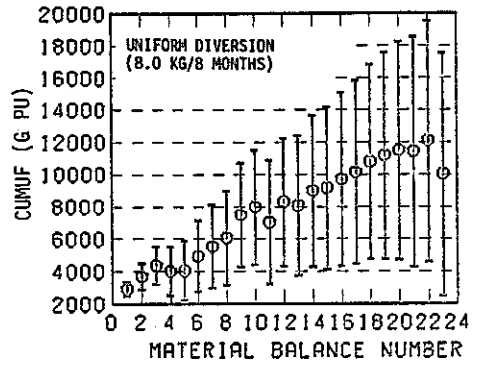
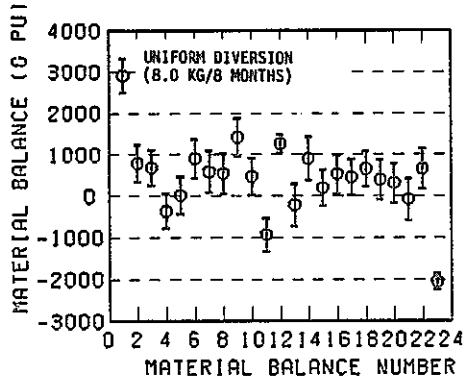

Fig. 5.49 CUMUF and uniform diversion tests for different estimation methods for unmeasured inventories with S.S.1-9-2 (no diversion); Simulation period: 8 months.



Patial PIT
Excluded
Mixer-settler
Inventory



Estimated
Unmeasured
Inventories
are First
MUF_d

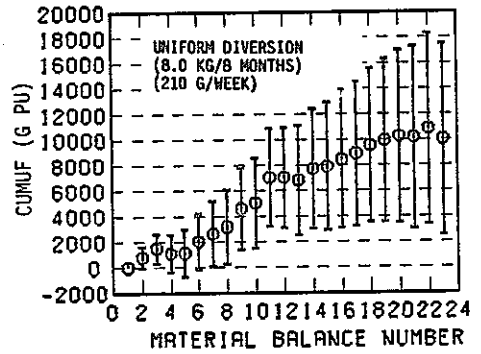
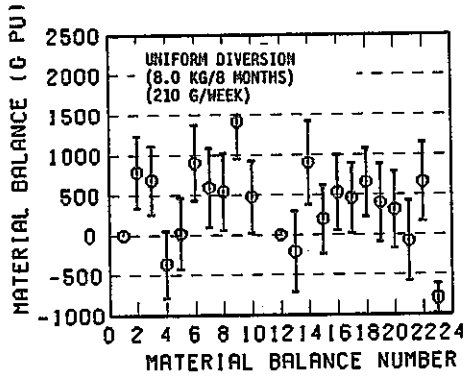

Full PIT
Estimation
Accuracy
of Mixer-
settler
Inventory
is 20%

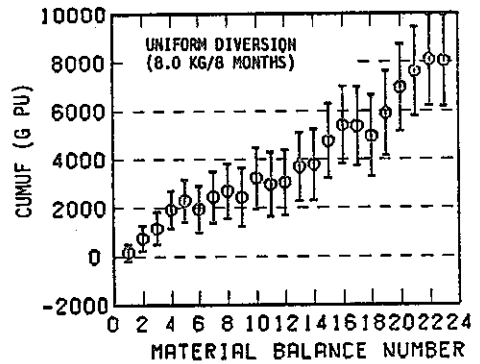
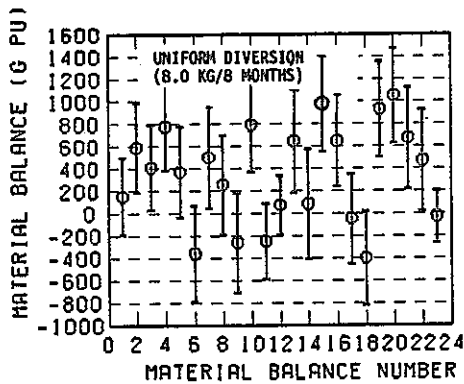
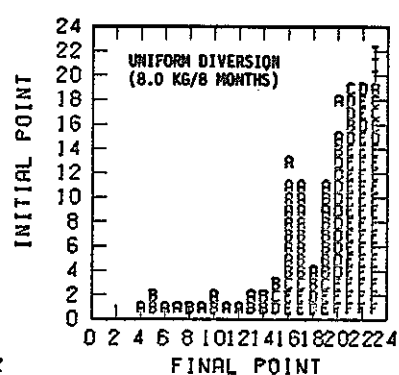
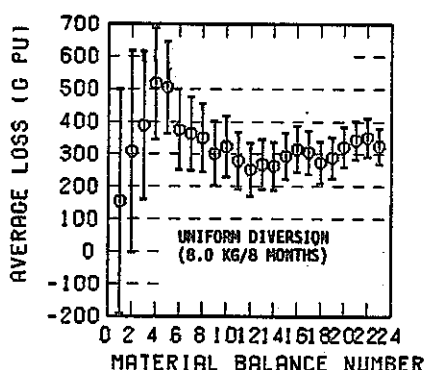
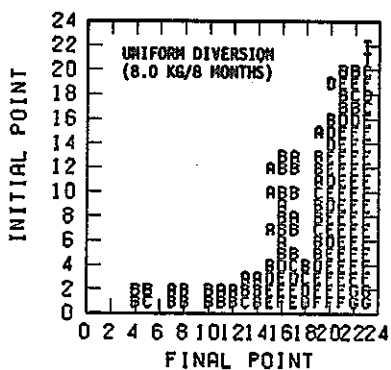
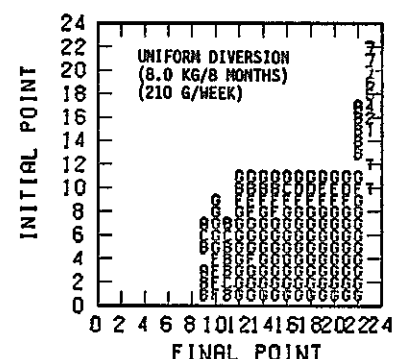
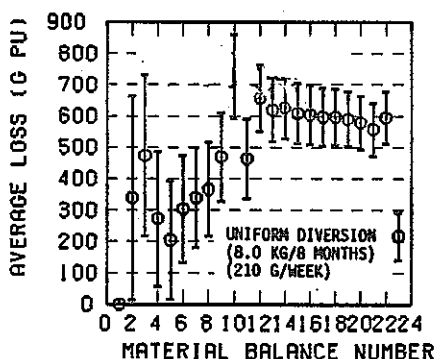
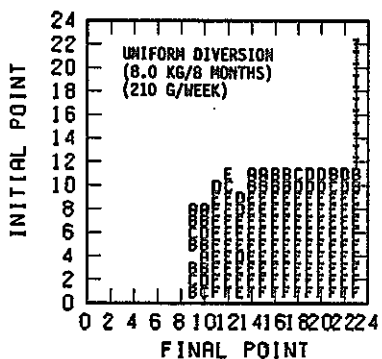
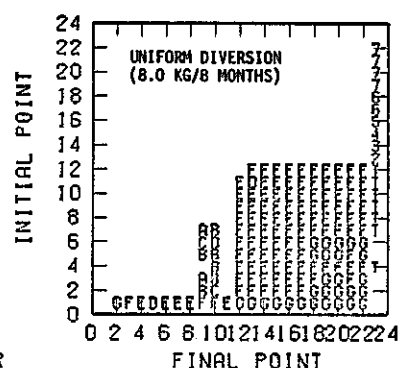
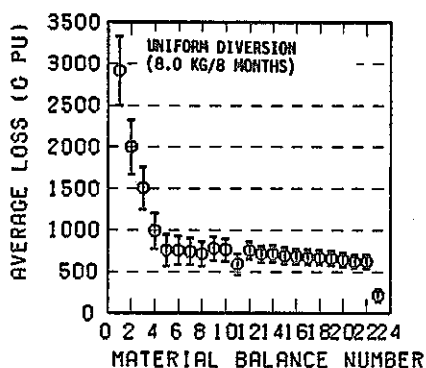
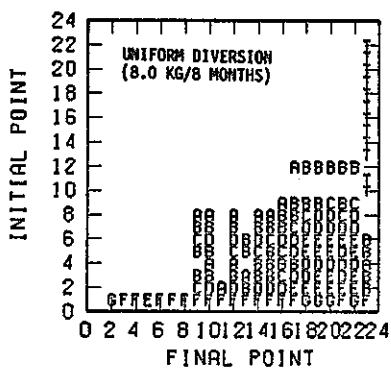
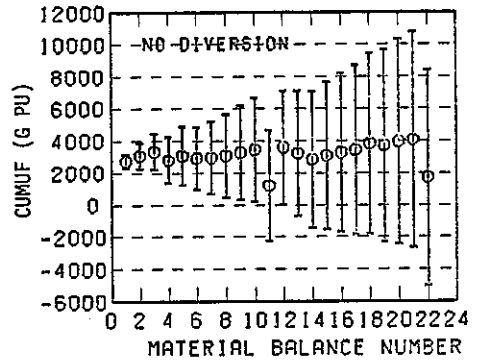
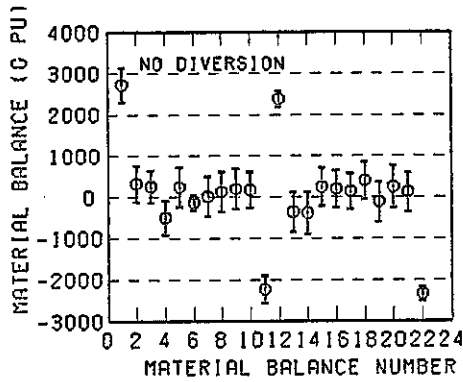

Fig. 5.50 CUMUF and uniform diversion tests for different estimation methods for unmeasured inventories with S.S.1-9-2 (uniform diversion of 8 kgs Pu per year); Simulation period : 8 months.



Patial PIT
Excluded
Mixer-settler
Inventory



Estimated
Unmeasured
Inventories
are First
MUF_d

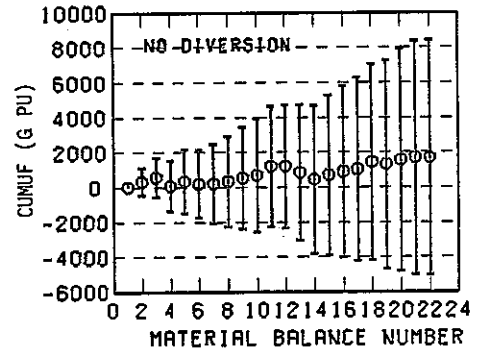
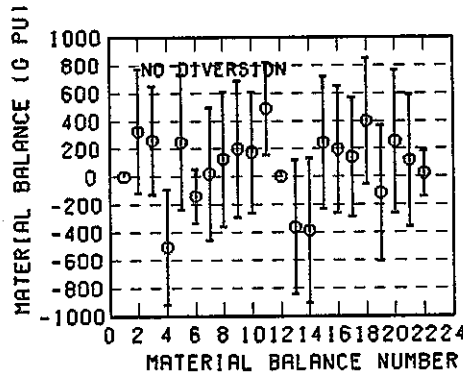

Full PIT
Estimation
Accuracy
of Mixer-
settler
Inventory
is 20%

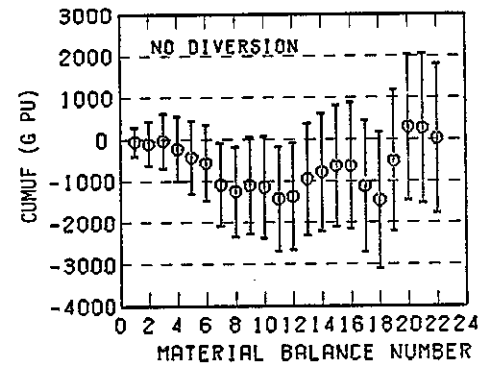
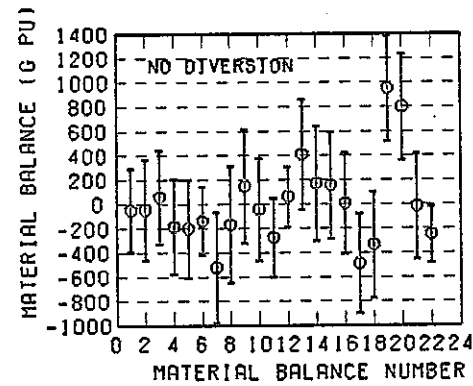
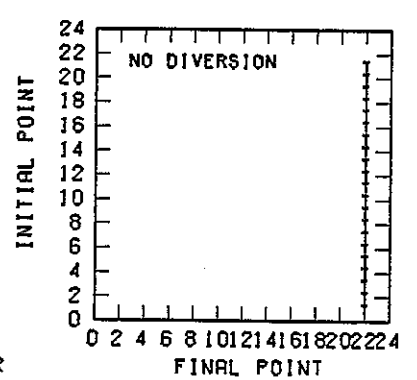
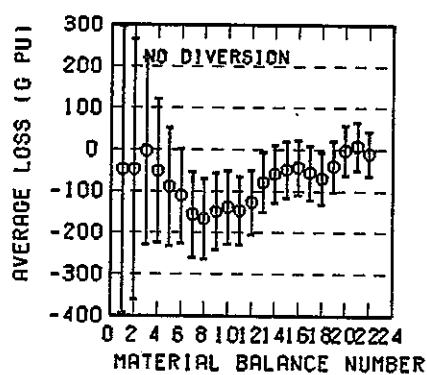
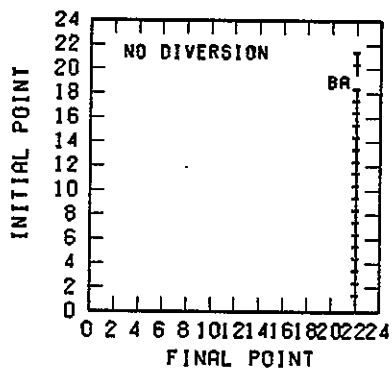
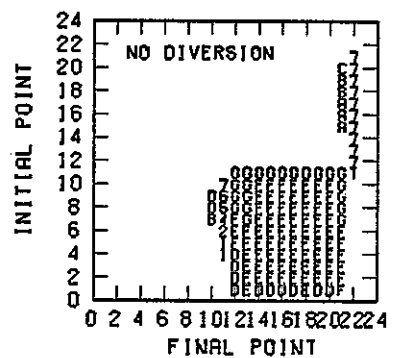
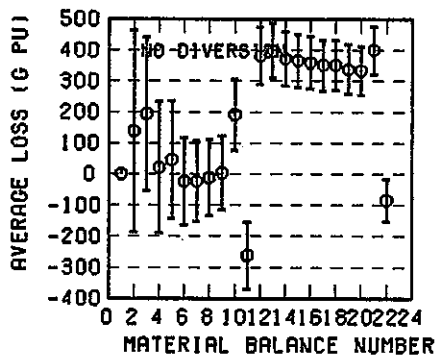
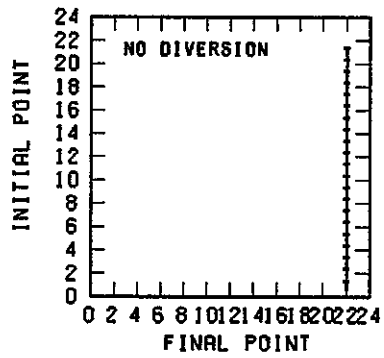
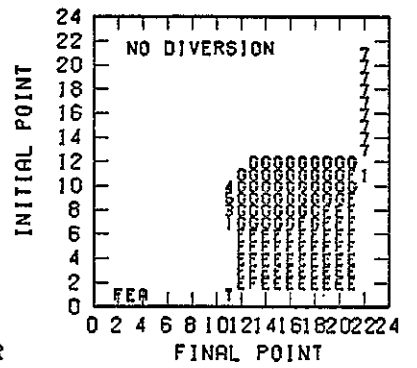
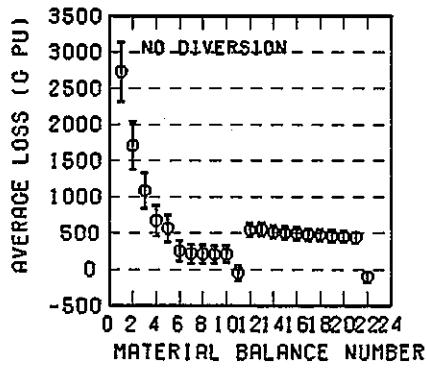
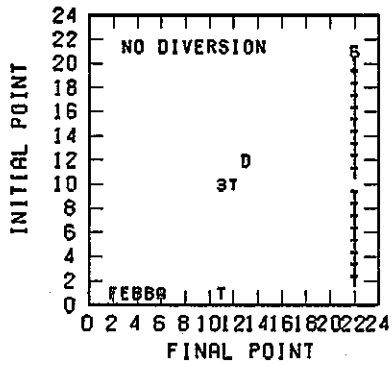
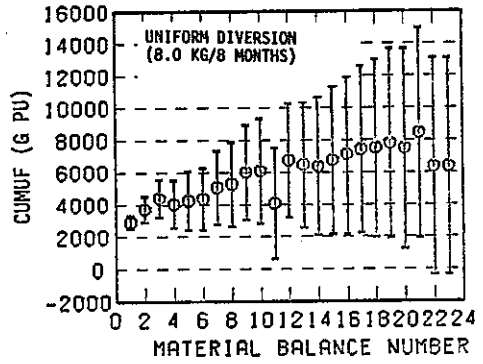
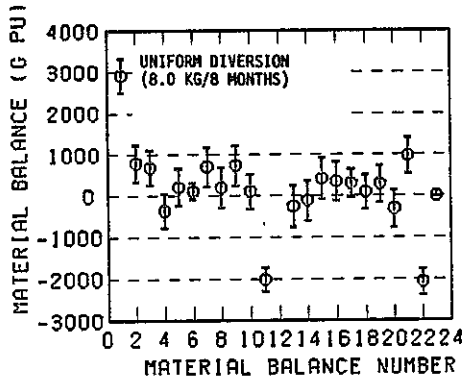

Fig. 5.51 CUMUF and uniform diversion tests for different estimation methods for unmeasured inventories with S.S.1-10-2 (no diversion); Simulation period: 8 months.



Partial PIT
Excluded
Mixer-settler
Inventory



Estimated
Unmeasured
Inventories
are First
MUF_d

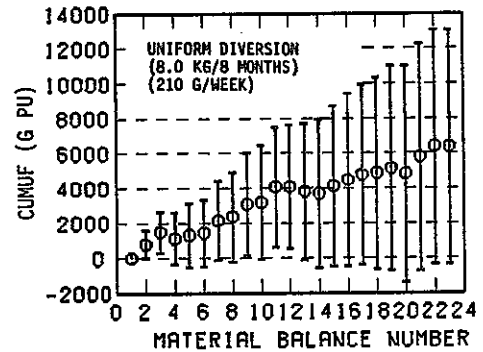
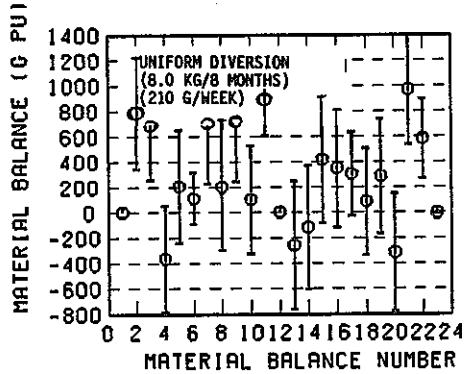

Full PIT
Estimation
Accuracy
of Mixer-
settler
Inventory
is 20%

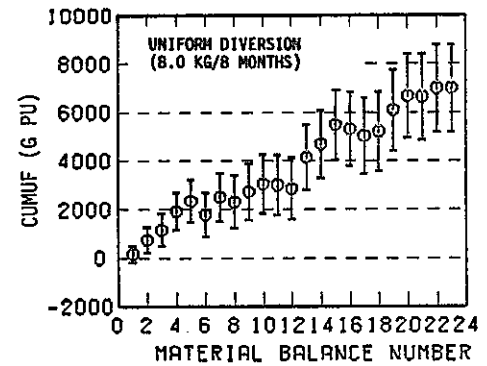
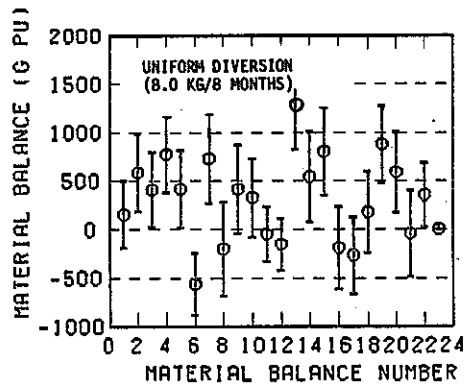
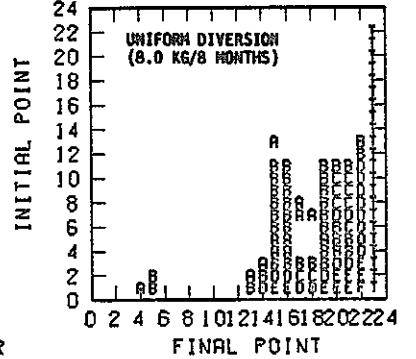
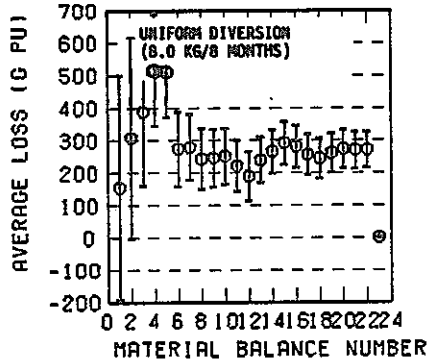
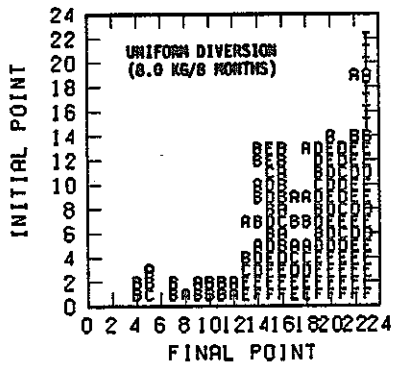
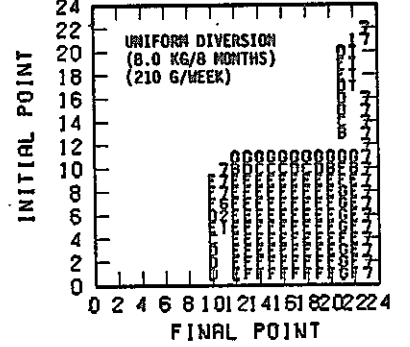
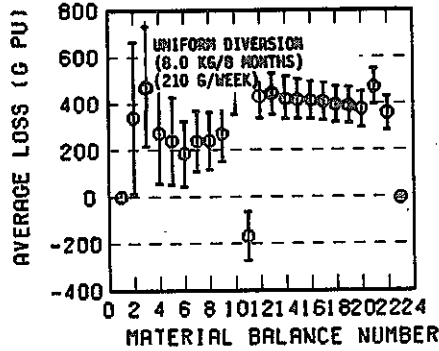
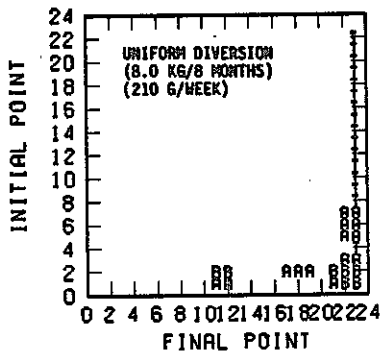
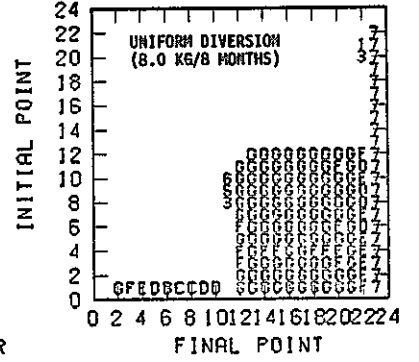
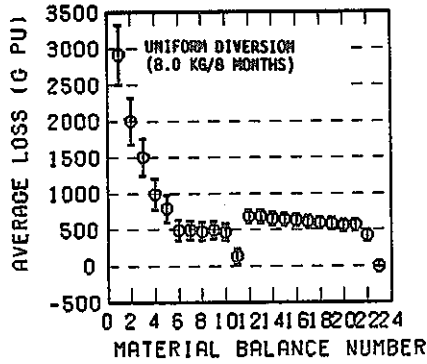
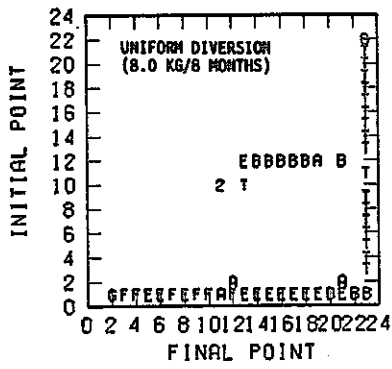

Fig. 5.52 CUMUF and uniform diversion tests for different estimation methods for unmeasured inventories with S.S.1-10-2 (uniform diversion); Simulation period: 8 months.



6. FIELD TESTING OF THE N.R.T. MATERIALS ACCOUNTANCY MODEL

6.1 Summary of the Field Test

The study of applying the proposed n.r.t. materials accountancy model, i.e., the 10-day-detection-time model, to the reprocessing facility has shown that the model would be feasible and effective to fulfil international safeguards criteria in terms of detection timeliness and sensitivity. This was shown on paper using computer simulation technique. In order to investigate the applicability of the model to the actual plant and the validity of the assumptions used in the model, a field test was planned and discussed at the third Joint Steering Committee Meeting (Feb. 26 ~ 29, 1980).

This field test has subsequently been carried out in the process MBA which covers the area from the input accountability vessel (IAV) to the product accountability vessel (PAV). The KMPs for in-process inventory taking (IPIT) are IAV and PAV in the process MBA and four other vessels that contain Pu in the main plant, i.e., feeding vessel for extraction process (FV 1), buffer vessel for Pu/U separation cycle (BV 2), buffer vessel for Pu purification cycle (BV 3) and buffer vessel for Pu evaporator (BV 4). These points are shown in Fig. 6.1.

The field test was carried out by performing in-process inventories nineteen times from April 1980 through February 1981. Results of the test are summarized as follows:

- (1) The Cumulative MUF (CUMUF) delivered from in-process inventories showed a fairly good agreement with the MUF established by the conventional materials accountancy based on clean-out PIT's.
- (2) A small increase in sampling and analytical effort was needed in the course of the field test. The man-power needed, however, was not as much as had been predicted.
- (3) In the field test the assumed seven days of n.r.t. material balance period (NRTMBP) was varied up to nine days in order to avoid interruption to the operation. Furthermore, it sometimes took more than the assumed three days to analyze samples because of limited equipment and man-power available.

As an overall conclusion, it can be said that the ten-day-detection-time model might be applicable to and effective for the Tokai reprocessing

plant as a basis for international safeguards measures, and that further investigation is desirable.

6.2 Planning of the Field Test

6.2.1 Working Group

It was the rule that the routine plant operation should be disturbed as little as possible in course of the implementation of the field test. In order to put the field test of in-process inventory into practice, however, it was necessary to carry out a volume measurement, sampling and chemical analysis for as well as the routine plant operation. Furthermore it was necessary to record and collect volume measurement data and various types of analyses during each n.r.t. material balance period.

In order to carry out this project smoothly, a special working group was organized within PNC. Instruction were given to the technicians who operate the plant processes for their better understanding of the content of the field test and the operations which were to be adjusted sufficiently so as to meet the field test requirements before it started. The working group was composed of seven specialists in the different fields, i.e., three from the process operation section, two from the analysis section, one from the instruments section and one from a management section that supervised the field test.

At the meeting of this working group the following topics were discussed and a detailed plan for execution was fixed.

- (a) Operational procedure of an in-process inventory;
- (b) Schedule of in-process inventory takings; and
- (c) Arrangement of the works needed for in-process inventories.

Information of the plan was transferred to all technicians concerned through the members of the working group.

6.2.2 Procedure for the Field Test of in-process Inventory

The field test was carried out in parallel with the normal plant activities. It was divided into three periods in accordance with the schedule of the routine plant operation. After each period the procedures performed were reviewed for improvement.

The procedure applied to the test is summarized as follows:

(a) Timing of In-process Inventories

It is impossible to estimate the Pu inventory in the Pu evaporator accurately. Therefore, the in-process inventory should be carried out during the time, when the Pu evaporator became empty. The time was called " cutoff point".

(b) Sampling and Analysis

Table 6.1 and 6.2 show sampling frequency, analytical items and time schedule for analyses. The layout of these vessels are shown in Fig. 6.1. Table 6.2 shows random errors of analyses for the in-process inventory.

(c) Estimation of MUFd

values of MUFd are collected by Eq.(2.2). Input data for Eq.(2.2) are collected from records of the accountancy and control data. All batch data relating to the input and product accountability vessels are collected by the formats shown in Tables 6.3, 6.4 and 6.5. In order to increase the accuracy of MUFd, all batch data of the waste units are collected. As the clean-out PITs were carried out during the field test, values of MUFd's were compared with traditional MUFs.

(d) Time Schedule

In an ordinary campaign the plant is operated as follows:

At first, shearing and dissolution are commenced. A few days later, active feed from the feeding vessel for extraction process comes out. After four or five days the first Pu product solution is produced and accounted for. Then, the plant is operated continuously. In regard to the procedure for terminating the campaign, the shearing and dissolution are finished first and then rinsing in the process is started. This rinsing is done by using nitric acid, and fission product, plutonium, uranium and solvent are cleaned out from the process by flush. A PIT of the plant is carried out after these operations finished.

In the first period of the field test, a time period from the first input measurement to the first Pu product measurement was taken to be the first n.r.t. material balance period. After the first period, NRTMBPs are established for every seven days. Actual n.r.t. material balance periods are extended to two or three weeks. Fig. 6.2 shows the planned time schedule and the performed one.

6.3 Implementation of the Field Test

The field test was carried out over the three campaigns, i.e. C-1, C-2 and C-3 Campaign, which covered the period from April 1980 through February 1981. Therefore it was inevitably divided into three parts. In-process inventory takings have been done 19 times: 7 in the first period, 8 in the second period and 4 in the third period. On the other hand PITs for formal accountancy purpose were carried out twice during these periods: one between C-1 and C-2 Campaign and the other between C-2 and C-3 Campaign (August 1, 1980 and December 9, 1980, respectively). The dates of campaigns and field tests are shown in Table 6.6 and the dates of in-process inventories performed are shown in Table 6.7.

As shown in Table 6.7, the in-process inventory was not always carried out within the interval of seven days. The reason is that: If the plant were operated without any trouble under the normal operating procedure, it could be done nearly weekly. In the period the field test, however, the plant was still under test operation in which the plant was sometimes obliged to stop the operation for several days. Therefore the requirement of weekly in-process inventory could not be satisfied. Another reason why weekly in-process inventory did not attained was that the cut-off point was rigidly chosen at a particular time point in a week (i.e., 0:00 a.m., Tuesday) in order to meet the requirement on the time schedule of the chemical analysis section.

The problems derived from the in-process inventory are described in the following subsections.

6.3.1 Volume Measurement

Pneumatic level measurement systems were used for volume measurement of vessels. Information from each vessel is transmitted through air pipes centralized in and recorded at the control room in the main plant. The volume measurement data at the cut-off point were obtained from these recorders. A recorder is divided in 1 % intervals and has a range of 0 to 100 %. A visual measurement is possible on the recorder within about 0.5 percent error. The range of error is about 1 %.

As for the input and product accountability vessels, the H₂O manometer with higher accuracy was used for the volume measurements because it had been available for the normal accountancy and control.

6.3.2 Sampling

The model says that the in-process inventory should be done at the time when there is no hold-up in the Pu evaporator during the plant operation. Moreover, it requires that the samples for in-process inventory should be taken within a limited time interval during which the volume and concentration of the solution in the six vessels are not varied significantly.

In practical plant operation, the time interval during which the Pu evaporator is empty is about one hour. On the other hand, it takes about two hours for taking samples from six measurement vessels because of the limited-manpower, characteristics of the sampling equipments and a circumstance of operation. However, the volume measurements of the six vessels are carried out within 30 minutes after the cut-off point by reading the recorders located in the control room. Since, in the six measurement vessels, the input and product accountability vessels are in a batch operation and the others are in a continuous equilibrium operation, it is expected that the change of the concentration of solution is not so big in the two hours after the cut-off point through the time when all sample takings are finished.

It should be noted that the sampling works are too tight in time because the samplings for the in-process inventory must be done as quickly as possible while, in parallel with these, samples for normal process operation should be taken under the plant process operation.

6.3.3 Chemical Analysis

The field test requires the chemical analysis of various samples taken for the in-process inventory as well as those for the process control and formal material accountancy.

Although the model requires that the volume measurements and chemical analyses of plutonium for all batches of the input accountability vessel should be completed within three days because that is essential to estimate the MUF for each ten days, this requirement as a fact could not be met satisfactorily in the field test carried out. At present in the Tokai Reprocessing Plant it is observed that at the middle stage of a long campaign the highly active samples taken from the input accountability vessel for the analyses of Pu concentration are being accumulated due to

limited equipment and lack of manpower. The reasons for this delay are considered to be that it takes a long time to pre-treat the samples from the input accountability vessel with high activity for the Pu analyses, that the analyses for material accountancy are requested to be highly accurate, and that the samples for material accountancy are analyzed on a day shift basis only.

In order to cope with this situation, a spectrophotometry analysis method was used for the in-process inventory to all batches of the input accountability vessel for the analyses of Pu concentration within 6 % random error (2 sigma). The data produced by this method is called "special plutonium data" in this report.

Then, as for the usage of the analysis data of the input accountability vessel in the field tests, the actual procedure is that the results of analyses for normal material accountancy are used if the data have been available within three days after cut-off point, otherwise the special plutonium data are used temporarily and replaced by the material accountancy data at the time when the results become available.

6.3.4 Collection of Data

In order to receive the data for the field test quickly and assuredly, they were collected in two ways. As for the volume measurements and chemical analyses that were intended for an in-process inventory only, the results were collected under the responsibility of the members of the working group and special working papers were used for recording them. On the other hand, all input and output data of the input accountability vessel, the product accountability vessel and waste units were picked up from the circulating route of the routine operation data because they are usually used for the ordinary accountancy and control purpose.

Furthermore, in addition to the field test of the in-process inventory, the operating records and analysis data of the extraction units were collected in the C-3 Campaign in order to evaluate the confidence of the SEPHIS code which estimates an inventory in the mixer-settler. It is necessary, however, to collect these data again in the future because enough data to compare the results of the SEPHIS code with the practical plant operation data could not be gathered.

6.4 Evaluation of Manpower required for Plant Operators

6.4.1 Volume measurement

The volume measurements need to be done in a fixed time during a limited time interval. It is easy, however, to carry out the measurements and they do not need large manpower, if a project team or a working group for the field test is established and its members keep a close cooperation each other.

6.4.2 Sampling

The manpower required for the sampling may be estimated using the ratio of the number of samples increased for in-process inventories to the total number of samples taken in same period.

In the C-1 Campaign, this ratio was only a few percent as a whole. On a single day basis, however, it was nearly ten percent at the time when an in-process inventory was practiced and, on a shift basis, it was 20 to 30 percents at the time when the samples for the in-process inventory were taken.

It is concluded from this fact that the samplings may bring a peak load into the routine operation.

6.4.3 Manpower related to Chemical Analyses

Chemical analyses of the samples taken from four process vessels for the in-process inventory were done using a method similar to routine chemical analyses once a week in average, and four items were analyzed for each vessel. If the samples taken for the in-process inventory may be analyzed within one week one by one, it will not be necessary to provide a lot of additional manpower. It is difficult, however, to receive the analytical results of these samples including the accountancy samples from the input and product accountability vessels within three days while maintaining the schedule for the chemical analyses which are needed to the routine process operation in view of the limited manpower and equipments, unless the method of chemical analyses, that is mainly destructive analysis at present, is changed.

6.5 Future Subjects with regard to Field Testing

6.5.1 Estimation of Inventories in Mixer-settler systems

In order to calculate MUFd it is necessary to estimate inventories in mixer-settler systems which are located in the process MBA. In the field test of the n.r.t. accountancy model the SEPHIS code was used for this purpose. It is not only a strong desire of all researchers who participated in the TASTEX Task-F to confirm the validity of the code experimentally, but also it will give a valuable information to us and to the plant operation.

6.5.2 Measurement Accuracy

The standard deviation of MUFd is a result of the error propagation of volume measurements, sampling and chemical analyses in the same way that the standard deviation of MUF is so derived. It is important to determine the magnitude of these error components as accurately as possible, both from the point of view of plant operation, i.e., material accountancy and control, and of national and international safeguards. In order to cope with this, further investigation of the methodology and its application to the field are needed.

Table 6.1 Sampling Time Schedule (Frequency) for In-process Inventory

Sampling Point	Phase	U	Pu	H ⁺	ρ (density)
I A V (Q ₁)	C-1	B.T	B.T	B.T	B.T
F V 1 (D ₁)	C-1	1/Week	1/Week	1/Week	1/Week
B V 2 (D ₂)	C-1	1/Week	1/Week	1/Week	1/Week
B V 3 (D ₃)	C-1	1/Week	1/Week	1/Week	1/Week
B V 4 (D ₄)	C-1	1/Week	1/Week	1/Week	1/Week
P A V (Q ₉)	C-1	B.T	B.T	B.T	B.T

Note: B.T ; Before Transfer Sampling for Process Control & Material Accountancy

Sampling Timing; According to Cut-off Point

Table 6.2 In-process Inventory Analytical Items, Accuracy and Time of Measurement

Measurement Point	Vessel Name	Analytical Items and Estimated value	Number of Times	Random Error 3 Sigma (%)	Time of Measurement	
					Time (min.)	Man-Power (man-day)
Q-1	IAV	U 180 g/l	2	9.0	60	0.5
		Pu 1 g/l		3.0	100	
		density		0.6	60	
		H ⁺ 3 N		4.0	60	
D-1	FV1	U 180 g/l	2	9.0	60	0.5
		Pu 1 g/l		3.0	100	
		density		0.6	60	
		H ⁺ 3 N		4.0	60	
D-2	BV2	U 50 g/l	2	5.0	} 150	0.5
		Pu 0.6 g/l		3.0		
		density		0.6	60	
		H ⁺ 3 N		4.0	60	
D-3	BV3	U 0.8 g/l	2	5.0	60	0.5
		Pu 2 g/l		3.0	100	
		density		0.6	60	
		H ⁺ 3.5 N		2.0	60	
D-4	BV4	U 0.1 g/l	2	5.0	60	0.5
		Pu 15 g/l		3.0	100	
		density		0.6	60	
		H ⁺ 1 N		2.0	60	
Q-9	PAV	Pu 250 g/l	2	1.2	half-day	0.5
		density		0.6	60	
		H ⁺ 8 N		2.0	60	

Table 6.3 In-process Inventory Estimation

301		DMBP Number				
302		Date of Measurement				
311	IAV	Time of Sampling				
312		Total Solution of Volume				
		Analytical Data				
313		U Concentration (g/l)				
314		Pu Concentration (g/l)				
315		H ⁺ Concentration (N)				
316		Solution Density				
321	FV1	Time of Sampling				
322		Total Solution of Volume				
		Analytical Data				
323		U Concentration (g/l)				
324		Pu Concentration (g/l)				
325		H ⁺ Concentration (N)				
326		Solution Density				
331	BV2	Time of Sampling				
332		Total Solution of Volume				
		Analytical Data				
333		U Concentration (g/l)				
334		Pu Concentration (g/l)				
335		H ⁺ Concentration (N)				
336		Solution Density				
341	BV3	Time of Sampling				
342		Total Solution of Volume				
		Analytical Data				
343		U Concentration (g/l)				
344		Pu Concentration (g/l)				
345		H ⁺ Concentration (N)				
346		Solution Density				
351	BV4	Time of Sampling				
352		Total Solution of Volume				
		Analytical Data				
353		U Concentration (g/l)				
354		Pu Concentration (g/l)				
354		H ⁺ Concentration (N)				
356		Solution Density				
361	PAV	Time of Sampling				
362		Total Solution of Volume				
		Analytical Data				
363		U Concentration (g/l)				
364		Pu Concentration (g/l)				
365		H ⁺ Concentration (N)				
366		Solution Density				

Table 6.4 Input Accountability Tank (IAV; Q₁)

101	Batch No.			
102	Numbers of Assembly			
103	Assembly No. (1)			
104	(2)			
105	(3)			
106	(4)			
107	Date of Measurement (Accounting)			
108	Total Solution Volume			
109	Heal of Previous Batch			
110	Previous Batch No.			
111	Time of Sampling			
	Analytical Data			
112	Date of Sampling Results			
113	U Concentration (g/l)			
114	Pu Concentration (g/l)			
115	H ⁺ Concentration (N)			
116	Solution Density			

Table 6.5 Pu Product Accountability Tank (PAV; Q₉)

201	Batch No.			
202	Date of Measurement (Accounting)			
203	Total Solution Volume			
204	Heal of Previous Batch			
203	Previous Batch No.			
204	Time of Sampling			
	Analytical Data			
205	Date of Sampling Results			
206	U Concentration (g/l)			
207	Pu Concentration (g/l)			
208	H ⁺ Concentration (N)			
209	Solution Density			

Table 6.6 Plant Operation Time Schedule during Field Test

	C-1	C-2	C-3
Period of Campai	Apr.17~ Jul.12, 1980	Sep.5~Dec.4, 1980	Jan.17, 1981~
Shearing start date	Apr.17, 1980	Sep.5, 1980	Jan.17, 1981
Active Feed start date ⁽¹⁾	Apr.23, 1980	Sep.8, 1980	Jan.20, 1981
1st Pu Product Out Put Day ⁽²⁾	Apr.28, 1980	Sep.12, 1980	Jan.26, 1981
Last Pu Product Out Put Day ⁽³⁾	Jun.25, 1980	Nov.19, 1980	Mar.4, 1981

- NOTE: 1) Active Feed Start Date; The day of feeding start from Feeding vessel (FV1) to Extraction 1st Cycle
- 2) 1st Pu Product
Out-Put Day; First day of Pu Product Accounting Vessel (PAV) was receipt Pu product solution from Pu Evapolator within some Campaign
- 3) Last Pu Product
Out-Put Day; Last day of Pu Product Accounting Vessel (PAV) was receipt Pu product solution from Pu Evapolator within some Campaign

Table 6.7 In-process Inventory Takings Performed

	C-1 Campaign		C-2 Campaign		C-3 Campaign	
	In-process Inventory	Interval 1)	In-process Inventory	Interval	In-process Inventory	Interval
#1 DPIT	Apr. 28 (Mon)		Sep. 12 (Fri)		Jan. 27 (Tue)	
#2 DPIT	May. 8 (Thu)	10 day	Sep. 16 (Tue)	4 day	Jan. 28 (Wed)	1 day
#3 DPIT	May. 28 (Wed)	20 day	Oct. 17 (Fri)	30 day	Feb. 3 (Tue)	6 day
#4 DPIT	Jun. 6 (Fri)	8 day	Oct. 28 (Tue)	11 day	Feb. 12 (Thu)	9 day
#5 DPIT	Jun. 10 (Tue)	4 day	Nov. 4 (Tue)	7 day		
#6 DPIT	Jun. 17 (Tue)	7 day	Nov. 13 (Thu)	9 day		
#7 DPIT			Nov. 18 (Tue)	5 day		
Times of DPIT	7 times		8 times		4 times	

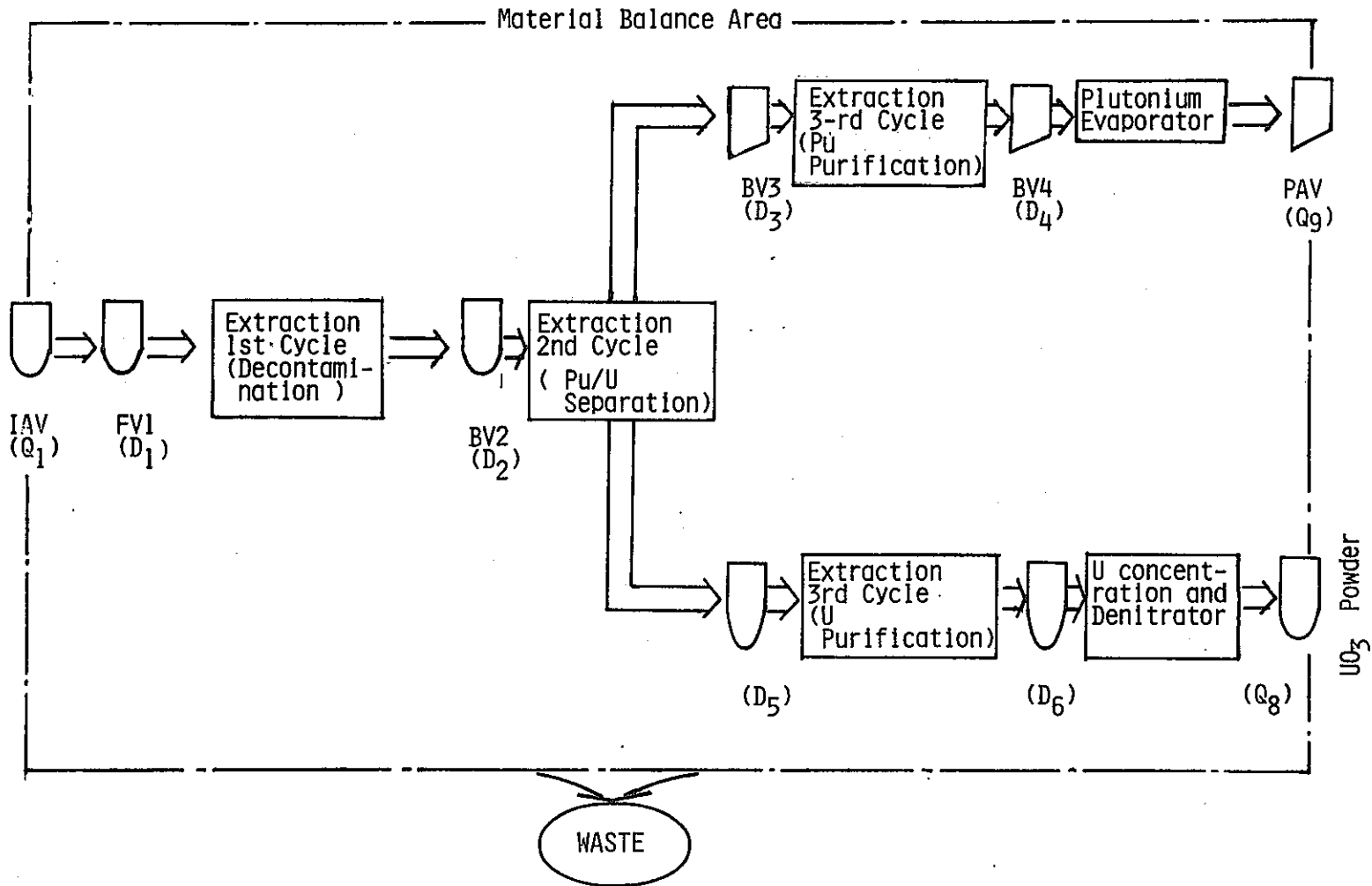

Fig. 6.1 Measurement Points for the In-process Inventory

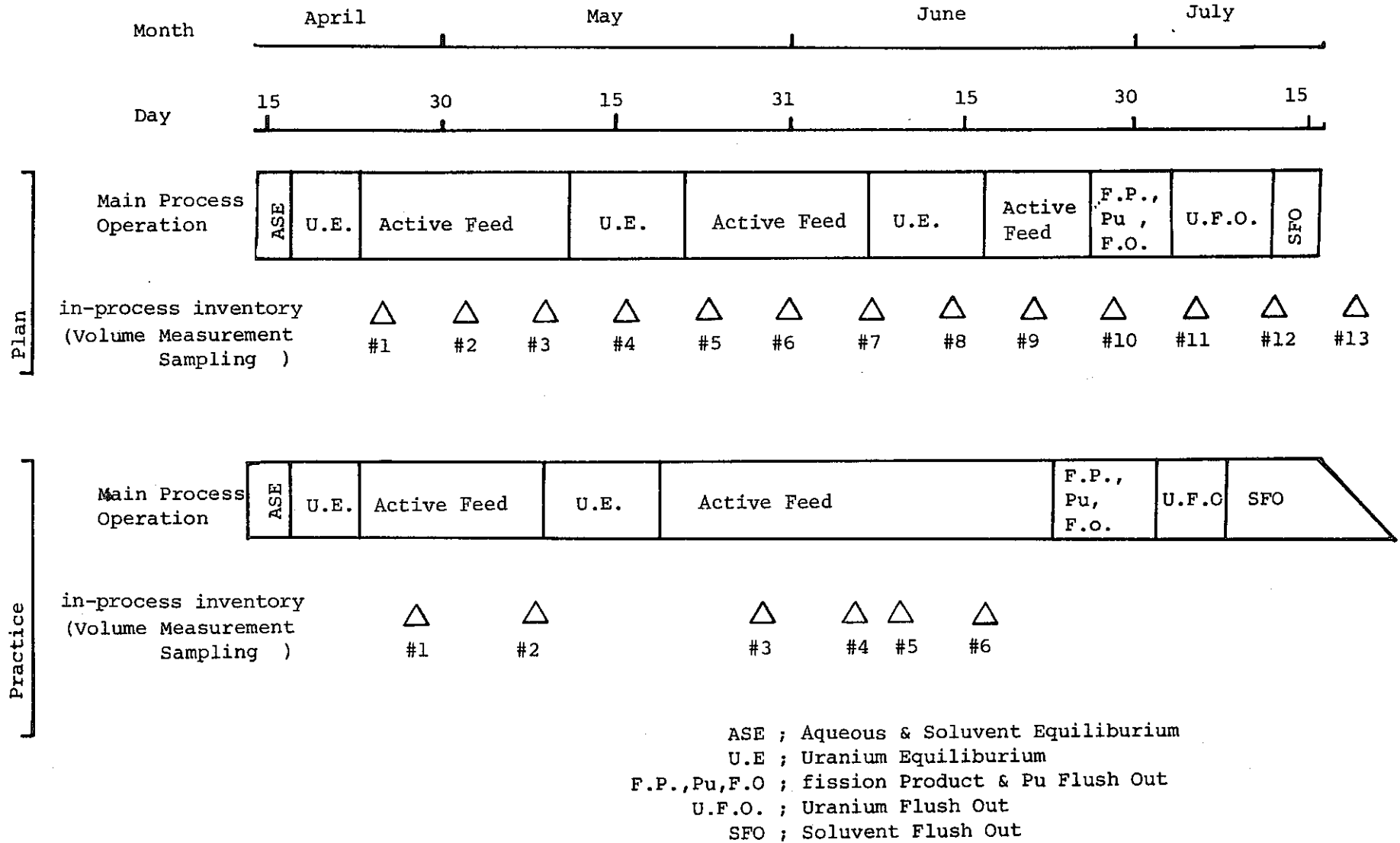

Fig. 6.2 A Campaign Plant Operation and 1st Part Field Test Time Schedule

7. EVALUATION OF THE N.R.T. MATERIALS ACCOUNTANCY MODEL

7.1 Evaluation of Field Test Data7.1.1 N.R.T. Accounting Data

N.R.T. accounting data were obtained during the C-1 and C-2 campaigns (May, 1980 February, 1981). These data are shown in Tables 7.1 to 7.6 and Figs. 7.1 to 7.7, contents of which are shown below;

Table 7.1 contains input batch data of MBA-2 for the C-1 and C-2 campaigns. These data consist of volume and concentration measurements for dissolved solution batches, and gross and net weights of plutonium contained in these batches.

Table 7.2 contains output batch data of plutonium products which were transferred to MBA-3 in C-1 and C-2 campaigns. The same kind of data as those for input are included in the table.

Table 7.3 contains output data for waste transferred from MBA-2 to the waste treatment facility in C-1 and C-2 campaigns.

Table 7.4 contains (in-process) inventory taking data of the designated six in-process inventory measurement points in the C-1 campaign. These measurement points are two formal flow KMP's (Q_1 and Q_9) and four in-process inventory KMP's ($D_1 \sim D_4$).*

Table 7.5 contains in-process inventory data in C-2 campaign.

Table 7.6 shows numerical results of n.r.t. material balance calculation in C-1 and C-2 campaigns. In this table three clean-out physical inventories are also included, but these inventories do not include those in analytical laboratory and Operation Testing Laboratory (OTL) because they are omitted from the proposed n.r.t. materials accountancy system (10-day-detection-time model). The conventional materials accountancy indicated -3562g Pu MUF for C-1 campaign, while the corresponding CUMUF (of MUF_d) was -3785 g Pu.** The difference is 223 g Pu which may be caused by inventory changes in OTL and Analytical Lab. during C-1 campaign.

* See Fig. 3.6

** By convention, a negative MUF indicates an apparent net gain of Pu.

- Fig. 7.1 shows MUF_d values in C-1 and C-2 campaigns. In this figure, all in-process inventory data are adjusted to include an estimated 4000 g unmeasured inventory. Only the first MUF_d is affected.
- Fig. 7.2 shows CUMUF values in C-1 and C-2 campaigns, which are calculated from the adjusted MUF_d values. A conventional MUF data based on a cleanout PIT is indicated by a symbol 'X'.
- Fig. 7.3 shows average loss(gain) in C-1 and C-2 campaigns which is estimated by the Two-state Kalman filter.
- Fig. 7.4 shows an alarm-sequence chart based on CUMUF Tests.
- Fig. 7.5 shows an alarm-sequence chart based on Uniform Diversion Tests.
- Fig. 7.6 shows MUF_d values corrected for a bias of 510 g Pu per NRTMBP, which was estimated from CUMUF, i.e., $Bias = CUMUF(15)/15$, where 15 is the number of n.r.t. material balance periods during C-1 and C-2 campaigns.
- Fig. 7.7 shows another MUF_d values corrected for a bias (319 g Pu/NRTMBP) which was estimated by the Twostate Kalman filter.

7.1.2 Evaluation of Field Test Data

a) Estimation of unmeasured inventory

As shown in Table 7.6, three clean-out PIT's were made during C-1 and C-2 campaigns, which gave information to estimate the quantity of unmeasured inventories that had been omitted from the proposed n.r.t. materials accountancy system. The unmeasured inventories should appear as a positive MUF_d in the first n.r.t. material balance period (NRTMBP) and after a clean-out physical inventory taking it should appear as a negative MUF_d in the last NRTMBP. Then, the average of the absolute values of these MUF_d gives an estimate of the unmeasured in-process inventories. It is obtained by

$$\left(\begin{array}{l} \text{unmeasured} \\ \text{inventory} \\ \text{in C-1} \end{array} \right) \doteq \frac{3834 + 4422}{2} = 4128 \text{ g Pu}$$

and

$$\left(\begin{array}{l} \text{unmeasured} \\ \text{inventory} \\ \text{in C-2} \end{array} \right) \doteq \frac{3135 + 4116}{2} = 3626 \text{ g Pu}$$

The difference in these two values is heavily influenced by the difference in processed fuel characteristics. In the present evaluation, a somewhat arbitrary figure of 4000 g Pu was used as a common unmeasured inventory in C-1 and C-2 campaigns in order to analyse all of MUF_d data in these campaigns as a one set. This figure is used to adjust all in-process inventory data to avoid a harmful effect on the sequential decision analyses.

Table 7.7 shows the simulated in-process inventory in MBA-2. According to this table, the unmeasured inventory was estimated as only 1.3 ~ 2.8 kg depending on processed fuel characteristics. The major contribution to this difference may come from smaller estimations of plutonium holdups in mixer-settler systems. To estimate these inventories, we used the code SEPHIS, which assumes a steady state process operation. However, in both campaigns the process had, in practice, been operated in very unstable conditions, which means that the SEPHIS model is not strictly valid for these estimations. This may explain the unexpected difference between the estimate by simulation and that by observed MUF_d data.

A secondary and minor contribution to this difference may also come from smaller estimates of inventories in various small pots, vessels, tanks, pipings, etc.

Table 7.7 In-process plutonium inventory and its fluctuation in MBA 2

Fuel Type	BWR	BWR	BWR	PWR	PWR	PWR
Burnup (MWD/ton)	10000	15000	20000	10000	20000	27500
Input Accountability Vessel(3)	1657	2154	2454	1978	3015	3598
Buffer Vessel(4)	1152	1910	2790	2131	3614	2481
Buffer Vessel(8)	495	854	871	660	1102	1330
Buffer Vessel(12)	468	534	705	521	833	950
Buffer Vessel(16)	364	481	545	421	699	1083
Pu Product Reception Vessel(18)	8320	8394	6357	8229	9493	8134
Sub-total of major inventory	12456	14324	13724	13954	18755	16721
Extraction I (5)	328	423	500	389	608	720
Extraction II (6)	48	62	74	57	89	106
Extraction III(9)	241	313	368	285	445	528
Extraction IV (10)	163	211	243	192	299	355
Extraction VIII(14)	232	300	351	274	428	511
Extraction IX (15)	135	175	203	158	248	298
Others (7,11,13)	148	192	226	176	275	328
Evaporator (17)*	0	0	0	0	0	0
Sub-total of minor inventory	1295	1676	1970	1531	2392	2846
Total Inventory in MBA 2	13751	16000	15694	15485	21147	19567
Ratio of Main to Total	91%	90%	87%	90%	89%	85%

* at the time when Evaporator became empty

b) Conventional Materials Accountancy Data and their evaluation

The conventional MUF data can be obtained from the figure of Table 7.6.

	$\frac{MUF_o}{}$	$\frac{\pm\sigma_{MUF}}{}$
C-1 campaign	-3785 g	1079 g
(C-1) + (C-2) campaign	-7657 g	1405 g

From these data the true MUF (MUF_t) can be calculated as follows;

Campaign	$MUF_t = MUF_o \pm 2\sigma_{MUF}$	$MUF_t = MUF_o \pm 3\sigma_{MUF}$
C-1	$-5,943g \leq MUF_t \leq -1,627g$	$-7,022g \leq MUF_t \leq -548g$
(C-1)+(C-2)	$-10,467g \leq MUF_t \leq -4,847g$	$-11,872g \leq MUF_t \leq -3,442g$

These figures indicate that the Hypothesis H_0 , that the observed MUF, MUF_o , is statistically zero, should be rejected with the significance level (α) less than 0.3 %.

There has been no indication that a significant quantity of plutonium probably greater than 1 kg, disappeared in the process MBA prior to C-1 campaign, such that it could reappear in the process MBA during the C-1 and C-2 campaigns. There are two logical alternatives.

- (i) σ_{MUF} has been under-estimated, because measurement errors assigned for the KMP's were declared too small (Table 5.4), or
- (ii) there is a significant measurement bias across the process MBA, resulting in a net gain of plutonium. There are three possibilities; i.e.,
 - o input measurements always indicate smaller amount than the true,
 - o output Pu product measurements always indicate larger amount than the true, or
 - o both of the above situations exist.

c) Near-Real-Time Materials Accountancy Data and Their Evaluation

In-process inventory taking data and conventional input and output measurement data were reduced to dynamic MUF data (MUFd), CUMUF data, average loss data by Kalman filter estimate, and alarm-sequence charts generated by sequential decision tests. These data are shown in Figs.7.1 to 7.7.

The systematic variation in MUF_d is dramatically shown by a graph of CUMUF, Fig. 7.2. This figure clearly shows that there is a measurement bias across the process MBA, resulting in an apparent net gain of plutonium. The nature of this bias was not clearly shown in conventional materials accountancy data. Fig. 7.2 gives a dramatic picture of the power of the near-real-time materials accountancy concept, and of the 10-day-detection-time model in the PNC-Tokai Plant, if adopted.

Fig. 7.3 shows an estimation of average loss per n.r.t. material balance period., which was obtained by the two-state Kalman filter. During the C-1 and C-2 campaigns, the Tokai plant was not operated steadily, and it therefore may not be appropriate to use the Kalman filter estimate as an estimate of bias. However, we use it as a very preliminary value for possible bias correction as described later.

Figs. 7.4 and 7.5 show alarm-sequence charts based on CUMUF tests and Uniform Diversion tests, respectively. These figures clearly show occurrences of net gain of plutonium with very low false alarm probabilities.

7.2 Improvement of Materials Measurement and Estimation

7.2.1 Bias Estimation and Correction

Two approaches to estimate a bias are used. This work is risky because of lack of theoretical strictness, but it is nevertheless suggestive for the people to identify the location of and estimate the exact quantity of the measurement bias.

The two-state Kalman filter estimate of an average loss at the last NRTMBP is 319 g Pu per n.r.t. material balance period. The other simple way to estimate the bias is to use CUMUF value at the last NRTMBP. It is given by the CUMUF value divided by the total number of n.r.t. material balance periods, and is equal to 510 g Pu per NRTMBP.

Fig. 7.6 shows new MUF_d data corrected for bias, and Fig. 7.7 shows CUMUFs based on these corrected MUF_d data. Fig. 7.7 indicates that the estimate by the Kalman filter is still too small to interpret the large MUF in the bias alone, while the other estimate given by CUMUF is fairly sufficient. In this case all of corrected MUF_d data except that at 4th NRTMBP can be sufficiently interpreted in terms of measurement uncertainties with the significance level of 5 %. In other words, almost

all MUF_d data could be explained as statistically zero with 5 % of type I error, provided a bias of about 500g Pu per NRTMBP could be identified and confirmed.

The second NRTMBP in C-1 campaign covers from April 29 to May 8, and during this NRTMBP, 14 input batches (total 24,708 g Pu) were measured at the input KMP and 5 output batches (total 25,930 g Pu) were measured at the output KMP. Therefore the average throughput in one n.r.t. material balance period is approximately 25,300 g Pu.

If the estimated 500 g Pu/NRTMBP measurement bias exists either in input measurement or in output measurement, then

(Possible Bias in Input Measurement or Output Measurement)

$$= \frac{500 \text{ g}}{25300 \text{ g}} = 0.020 = 2 \%$$

Alternatively, if the bias exists in both input and output measurements, then

(Possible Bias in Input measurement and Output measurement)

$$= \frac{2 \%}{2} = 1 \%$$

These data should be compared with estimates of long term systematic error given in Table 5.4.

The results of the preliminary study on bias correction clearly indicate that an urgent and detailed further investigation on this matter is required.

7.2.2 Estimation of Inventory Hold-up in Mixer-Settler Systems

The original proposal for near-real-time materials accountancy in the PNC-Tokai facility included an estimation of the plutonium inventory in the mixer-settler systems using a computer simulation model and the measured aqueous feed rates and concentrations. Progress in this area has been slow. The problem is not critical to a demonstration of near-real-time materials accountancy in the PNC-Tokai facility because of the relatively

small facility size. It will be a more important problem, however, in determining the ultimate detection sensitivity of the concept when applied to larger facilities.

The dynamic MUF data in Fig. 7.1, for example, show the effect of using a SEPHIS calculation to estimate the plutonium inventory in the mixer-settlers during the C-1 campaign. The apparent MUF loss during the 4th period led the sequential decision analysis to a conclusion of no apparent MUF pattern. The corrected dynamic MUF data clearly show that this apparent MUF loss was the result of an unusually high mixer-settler system inventory at that time.

It is now questioned by some experts working on solvent extraction system models whether SEPHIS, being an equilibrium state model, can always dependably estimate the actual inventory in a non-equilibrium system, even when that system is operating relatively smoothly at steady-state. A new code, PUBG⁽¹⁰⁾, has been developed specifically for mixer-settler systems.

The PUBG work has shown that the total Pu inventory, the only quantity of safeguards interest, is a sensitive function of the feed and waste concentrations. Since these are quantities which are already available, it is hoped that a simplified model can be developed along the lines of $H = AC_f + BC_w$, where H is the plutonium inventory, C_f and C_w are the aqueous feed and aqueous waste concentrations, respectively, and A and B are constants determined from PUBG modelling.

7.3 Verification for International Safeguards

Examination of the question of verification for international safeguards has led to several useful conclusions. First, it is concluded that the problem of rapid, timely verification against the gross falsifications necessary to conceal an assumed abrupt diversion can be separated from the problem of highly accurate verifications needed to detect possible small falsifications which might conceal an assumed protracted diversion. The former must be timely but need not be accurate, the latter must be accurate but need not be timely. There are no verifications which must be both.

Second, it is concluded that relatively little verification effort need be directed toward inventory data, first because the magnitude of the in-process physical inventory is relatively small, such that its falsification to conceal an assumed abrupt diversion would be difficult, and second because the frequent repetitions of the in-process inventory

make even small falsifications unproductive.

Third, it is concluded that the assumed continuous presence of an inspector results in the availability of considerable collaborative data which can be used to provide approximate verifications.

The study of verification for IAEA safeguards has not yet progressed to the point where it is possible to specify a complete set of verification procedures. Some examples can be given, however. The input measurement, for example, can be roughly verified by two methods. One involves comparison of the total plutonium found on dissolution with the plutonium expected based on reactor calculations. Much has been written about the unreliability of the latter, and in terms of precise verifications reactor calculations probably are unreliable. From the actual data collected during the C-1/C-2 campaigns, however, the difference normally is less than 200 gms Pu, and the average difference tends reasonably well toward zero. If falsifications are limited to less than 200 gms Pu per batch, 40 batches, over a period of at least three weeks, must be falsified. Since the data should tend toward zero, any sequence of 30-40 batches in which the difference was consistently large would be cause for investigation and more careful verification. In the absence of such a consistent pattern, the inspector can assume that input measurements are not being grossly falsified, and can wait for the conventional chemical verification to confirm the absence of smaller falsifications.

A second verification of the input measurement can be obtained from a comparison of Pu/U ratios found with those expected based on reactor calculations. Again, the verification is not precise, but it is adequate to detect falsifications in the range of 150-200 gms Pu or more, thereby gaining time for the performance of more precise verifications.

The minimum falsification which extended over every flow batch during an entire year of operation at nominal capacity, would achieve a diversion of 8 kgs Pu, is about 10 grams. This is about 0.16-0.30% for a typical batch, depending on the type of batch. Since the assumption is that the falsification is repeated in every batch for an entire year, detection at this level does not appear to be out of the question. Multiple period statistical techniques, in particular tests based on the Kalman filter statistic, should be able to contribute to an increased detection sensitivity in this range.

Table 7.1 Input Batch Accounting Data in C-1 and C-2 Campaigns (Plutonium)

..... ACCOUNTABILITY VESSEL						
DATE	HOUR	BATCH NAME	VOLUME (L)	CONCENTRA- TION (G/L)	GROSS WEIGHT (G)	NET WEIGHT (G)
4/21	21:55	JP1-016	1774.23	0.2480	440.01	
4/21	23:18	HEEL	5.48	0.2480	1.36	438.65
4/24	9:25	JP1-017	1753.87	0.2500	438.47	
4/24	10:49	HEEL	5.64	0.2500	1.41	437.06
4/25	5: 4	JP1-018	1452.56	0.2180	316.66	
4/25	6:25	HEEL	4.71	0.2180	1.03	315.63
4/26	2:45	JP1-019	1790.51	0.2210	395.70	
4/26	4:15	HEEL	4.94	0.2210	1.09	394.61
4/26	4:55	FU1-031	1888.23	0.7730	1459.60	
4/26	8:38	HEEL	9.59	0.7730	7.41	1452.19
4/26	19:55	FU1-032	1965.59	0.9100	1788.69	
4/27	1:10	HEEL	9.59	0.9100	8.73	1779.96
4/27	20:30	FU1-033	1992.93	0.9040	1801.61	
4/27	21:29	HEEL	9.59	0.9040	8.67	1792.94
4/28	9:40	FU1-034	1920.85	1.0150	1949.66	
4/28	10:37	HEEL	8.10	1.0150	8.22	1941.44
4/28	23:37	FU1-035	1778.30	1.0120	1799.64	
4/29	0:30	HEEL	7.67	1.0120	7.76	1791.88
4/29	21:15	FU1-036	2061.45	0.9270	1910.96	
4/29	22:10	HEEL	9.59	0.9270	8.89	1902.07
5/ 1	14:30	FU1-037	2062.82	0.9080	1873.04	
5/ 1	15:25	HEEL	9.59	0.9080	8.71	1864.33
5/ 2	5:25	FU1-038	2108.04	0.8950	1886.70	
5/ 2	6:24	HEEL	9.59	0.8950	8.58	1878.11
5/ 2	17: 3	FU1-039	1802.73	0.7690	1386.30	
5/ 2	17:55	HEEL	9.59	0.7690	7.37	1378.92
5/ 3	4:30	FU1-040	1916.73	0.8600	1648.39	
5/ 3	5:27	HEEL	9.59	0.8600	8.25	1640.14
5/ 3	17:55	FU1-041	1924.88	0.8420	1620.75	
5/ 3	18:53	HEEL	9.59	0.8420	8.07	1612.67
5/ 4	6:32	FU1-042	1858.28	0.8680	1612.99	
5/ 4	7:28	HEEL	9.59	0.8680	8.32	1604.66
5/ 4	19:46	FU1-043	1810.87	0.8450	1530.19	
5/ 4	20:41	HEEL	9.59	0.8450	8.10	1522.08
5/ 5	9:40	FU1-044	1859.73	0.9430	1753.73	
5/ 5	10:35	HEEL	9.59	0.9430	9.04	1744.68
5/ 5	22:55	FU1-045	1900.45	0.9370	1780.72	
5/ 5	23:51	HEEL	9.59	0.9370	8.99	1771.74
5/ 6	14:48	FU1-046	1819.01	1.0140	1844.48	
5/ 6	15:40	HEEL	9.59	1.0140	9.72	1834.75
5/ 7	14:25	FU1-047	2379.37	0.8520	2027.22	
5/ 7	15:30	HEEL	9.59	0.8520	8.17	2019.05
5/ 7	20: 0	FU1-047	894.75	0.1900	170.00	
5/ 7	20: 0	HEEL	9.59	0.1900	1.82	168.18
5/ 8	16: 7	FU1-047	731.88	0.1200	87.83	
5/ 8	16: 7	HEEL	9.59	0.1200	1.15	86.67
5/ 9	7:30	FU1-047	1077.97	0.0700	75.46	
5/ 9	7:30	HEEL	9.59	0.0700	0.67	74.79
5/21		OTHERS	280.00	0.0	0.0	
5/21		HEEL	0.0	0.0	0.0	0.0

Table 7.1 Cont'd

..... ACCOUNTABILITY VESSEL						
DATE	HOUR	BATCH NAME	VOLUME (L)	CONCENTRA- TION (G/L)	GROSS WEIGHT (G)	NET WEIGHT (G)
5/21		OTHERS	1700.00	0.0017	2.97	
5/21		HEEL	0.0	0.0	0.0	2.97
5/23		OTHERS	300.00	0.0	0.0	
5/23		HEEL	0.0	0.0	0.0	0.0
5/26		OTHERS	1030.00	0.0001	0.08	
5/26		HEEL	0.0	0.0001	0.0	0.08
5/27		OTHERS	510.00	0.0084	4.28	
5/27		HEEL	0.0	0.0084	0.0	4.28
5/27		OTHERS	560.00	0.0	0.0	
5/27		HEEL	0.0	0.0	0.0	0.0
5/31		OTHERS	380.00	0.0	0.0	
5/31		HEEL	0.0	0.0	0.0	0.0
5/18	7:26	FU1-048	1334.49	0.8420	1123.64	
5/18	8: 2	HEEL	9.08	0.8420	7.65	1116.00
5/18	15:35	FU1-049	1884.16	0.9320	1756.04	
5/18	16:28	HEEL	9.59	0.9320	8.94	1747.10
5/20	2:15	FU1-050	1843.44	0.8780	1618.54	
5/20	3:10	HEEL	9.59	0.8780	8.42	1610.12
5/20	16:17	FU1-051	1997.04	0.7950	1587.65	
5/20	17:16	HEEL	9.59	0.7950	7.62	1580.02
5/21	11: 7	FU1-052	2165.59	0.7350	1591.71	
5/21	12: 5	HEEL	5.48	0.7350	4.03	1587.68
5/22	2:15	FU1-053	2091.60	0.7500	1568.70	
5/22	3:15	HEEL	9.59	0.7500	7.19	1561.51
5/22	16:10	FU1-054	2580.81	0.7170	1850.44	
5/22	19:26	HEEL	10.12	0.7170	7.26	1843.18
5/22	23:45	FU1-054	1147.19	0.1910	219.11	
5/22	23:45	HEEL	9.59	0.1910	1.83	217.28
5/24	14:10	FU1-055	1399.63	0.9860	1380.04	
5/24	14:53	HEEL	9.59	0.9860	9.46	1370.58
5/24	23: 0	FU1-056	1798.66	1.0190	1832.83	
5/24	23:52	HEEL	9.59	1.0190	9.77	1823.06
5/25	15:58	FU1-057	1871.95	1.1540	2160.23	
5/25	16:50	HEEL	9.59	1.1540	11.07	2149.16
5/26	5:55	FU1-058	2186.15	0.8950	1956.60	
5/26	6:58	HEEL	9.59	0.8950	8.58	1948.02
5/26	23:30	FU1-059	2128.59	0.8730	1858.26	
5/27	0:35	HEEL	9.59	0.8730	8.37	1849.89
5/27	18:30	FU1-060	2346.48	0.8810	2067.25	
5/27	19:37	HEEL	9.59	0.8810	8.45	2058.80
5/28	12:16	SH1-001	1843.44	1.1420	2105.21	
5/28	13:10	HEEL	9.59	1.1420	10.95	2094.26
5/29	3:15	SH1-002	1985.95	1.2140	2410.94	
5/29	4:15	HEEL	9.59	1.2140	11.64	2399.30
5/29	19: 0	SH1-003	1916.73	1.2070	2313.49	
5/29	19:56	HEEL	9.59	1.2070	11.58	2301.92
5/30	7:30	SH1-004	1990.24	1.2480	2483.82	
5/30	8:27	HEEL	11.20	1.2480	13.98	2469.84
5/30	21:20	SH1-005	2013.49	1.1730	2361.82	
5/30	22:18	HEEL	9.59	1.1730	11.25	2350.57

Table 7.1 Cont'd

..... ACCOUNTABILITY VESSEL						
DATE	HOUR	BATCH NAME	VOLUME (L)	CONCENTRA- TION (G/L)	GROSS WEIGHT (G)	NET WEIGHT (G)

5/31	16: 2	SH1-006	2272.48	1.1170	2538.36	
5/31	17: 7	HEEL	9.59	1.1170	10.71	2527.65
6/ 1	19:45	SH1-007	2050.49	1.0960	2247.34	
6/ 1	20:40	HEEL	9.59	1.0960	10.51	2236.83
6/ 2	9:50	SH1-008	1977.81	1.0730	2122.19	
6/ 2	10:42	HEEL	9.59	1.0730	10.29	2111.90
6/ 2	20:43	SH1-009	1920.81	1.1320	2174.36	
6/ 2	21:37	HEEL	9.59	1.1320	10.86	2163.50
6/ 3	8: 0	SH1-010	1880.09	1.1790	2216.63	
6/ 3	8:35	HEEL	9.59	1.1790	11.31	2205.32
6/ 4	8: 5	SH1-011	1847.52	1.2110	2237.35	
6/ 4	9: 0	HEEL	9.59	1.2110	11.61	2225.73
6/ 5	13: 4	SH1-012	1794.58	1.0940	1963.27	
6/ 5	13:53	HEEL	9.59	1.0940	10.49	1952.78
6/ 4	22:53	SH1-013	1876.02	1.2050	2260.60	
6/ 4	23:48	HEEL	9.59	1.2050	11.56	2249.05
6/ 6	2:53	SH1-014	2099.82	1.0960	2301.40	
6/ 6	3:54	HEEL	9.59	1.0960	10.51	2290.89
6/ 6	15:16	SH1-015	1713.15	1.2100	2072.91	
6/ 6	16: 7	HEEL	9.59	1.2100	11.60	2061.31
6/ 7	5:20	SH1-016	1961.52	1.2490	2449.94	
6/ 7	6:20	HEEL	9.59	1.2490	11.98	2437.96
6/ 7	17:30	SH1-017	1725.37	1.2480	2153.26	
6/ 7	18:23	HEEL	9.59	1.2480	11.97	2141.29
6/ 8	8: 0	SH1-018	1965.59	1.2390	2435.37	
6/ 8	8:57	HEEL	9.59	1.2390	11.88	2423.48
6/ 8	19:47	SH1-019	1684.65	1.2370	2083.91	
6/ 8	20:38	HEEL	9.59	1.2370	11.86	2072.05
6/ 9	10: 0	SH1-020	2029.93	1.2730	2584.10	
6/ 9	11: 0	HEEL	9.59	1.2730	12.21	2571.89
6/ 9	22: 0	SH1-021	1745.72	1.2050	2103.59	
6/ 9	22:53	HEEL	9.59	1.2050	11.56	2092.04
6/10	13:45	SH1-022	1831.23	1.2630	2312.84	
6/10	14:37	HEEL	9.59	1.2630	12.11	2300.73
6/11	20:20	SH1-023	1839.37	1.1030	2028.83	
6/11	21:11	HEEL	9.59	1.1030	10.58	2018.25
6/11	7: 0	SH1-024	2206.70	1.1710	2584.05	
6/11	8:30	HEEL	9.59	1.1710	11.23	2572.82
6/12	11:16	SH1-025	2564.36	1.1570	2966.96	
6/12	12:30	HEEL	9.59	1.1570	11.10	2955.87
6/13	12:58	SH1-026	1928.95	1.0230	1973.32	
6/13	13:52	HEEL	9.59	1.0230	9.81	1963.51
6/13	21:26	SH1-027	1790.51	1.0860	1944.49	
6/13	22:19	HEEL	9.59	1.0860	10.41	1934.08
6/14	10: 8	SH1-028	1835.30	1.2530	2299.63	
6/14	11: 4	HEEL	9.59	1.2530	12.02	2287.61
6/15	6:13	SH1-029	1814.94	1.1610	2107.15	
6/15	7: 4	HEEL	9.59	1.1610	11.13	2096.01
6/15	16:27	SH1-030	1916.73	1.1930	2286.66	
6/15	17:22	HEEL	9.59	1.1930	11.44	2275.22

Table 7.1 Cont'd

..... ACCOUNTABILITY VESSEL						
DATE	HOUR	BATCH NAME	VOLUME (L)	CONCENTRA- TION (G/L)	GROSS WEIGHT (G)	NET WEIGHT (G)
6/16	4:55	SH1-031	1928.95	1.2580	2426.62	
6/16	5:53	HEEL	9.59	1.2580	12.06	2414.55
6/16	18:0	SH1-032	1831.23	1.2290	2250.58	
6/16	18:55	HEEL	9.59	1.2290	11.79	2238.80
6/17	9:0	SH1-033	1924.88	1.2500	2406.10	
6/17	9:56	HEEL	9.59	1.2500	11.99	2394.11
6/17	21:45	SH1-034	1794.58	1.3450	2413.71	
6/17	22:40	HEEL	9.59	1.3450	12.90	2400.81
6/18	15:0	HA1-001	1823.09	1.0780	1965.29	
6/18	15:53	HEEL	9.08	1.0780	9.79	1955.50
6/18	23:35	HA1-002	1798.66	0.9760	1755.49	
6/19	0:30	HEEL	10.12	0.9760	9.88	1745.62
6/19	16:30	HA1-003	2034.04	0.8070	1641.47	
6/19	17:30	HEEL	9.59	0.8070	7.74	1633.73
6/20	2:10	HA1-004	1847.52	0.8720	1611.04	
6/20	3:5	HEEL	10.12	0.8720	8.82	1602.21
6/20	17:0	HA1-005	1814.94	0.9290	1686.08	
6/20	17:53	HEEL	9.59	0.9290	8.91	1677.17
6/21	3:30	HA1-006	1831.23	0.9520	1743.33	
6/21	4:25	HEEL	9.59	0.9520	9.13	1734.20
6/21	17:46	HA1-007	1798.66	0.9670	1739.30	
6/21	18:39	HEEL	9.59	0.9670	9.27	1730.03
6/22	8:7	HA1-008	1476.99	0.9410	1389.85	
6/22	8:48	HEEL	9.59	0.9410	9.02	1380.82
6/22	12:40	HA1-008	1110.54	0.1880	208.78	
6/22	12:40	HEEL	9.59	0.1880	1.80	206.98
6/23	14:0	HA1-008	829.60	0.1000	82.96	
6/23	14:0	HEEL	9.59	0.1000	0.96	82.00
6/19	20:37	OTHERS	332.00	0.0001	0.02	
6/20	0:0	HEEL	0.0	0.0001	0.0	0.02
6/19	15:33	OTHERS	160.00	0.0001	0.01	
6/19	15:43	HEEL	0.0	0.0001	0.0	0.01
6/19	22:40	OTHERS	134.14	1.3200	177.06	
6/19	22:42	HEEL	107.27	1.3200	141.60	35.47
6/17		OTHERS	395.00	0.0005	0.21	
6/17		HEEL	0.0	0.0005	0.0	0.21
6/12		OTHERS	438.00	0.0274	12.00	
6/12		HEEL	0.0	0.0274	0.0	12.00
6/5		OTHERS	154.19	1.3200	203.53	
6/5		HEEL	125.91	1.3200	166.20	37.33
6/30		OTHERS	400.00	0.0007	0.30	
6/30		HEEL	0.0	0.0007	0.0	0.30
9/8	4:0	GE1-001	1395.56	1.7520	2445.02	
9/8	10:0	HEEL	9.59	1.7520	16.80	2428.22
9/8	22:0	GE1-002	1912.66	1.7420	3331.85	
9/9	18:0	HEEL	10.12	1.7420	17.63	3314.22
9/10	7:0	GE1-003	2120.37	1.7270	3661.88	
9/11	6:0	HEEL	10.12	1.7270	17.48	3644.40
9/11	19:0	GE1-004	2108.04	1.7210	3627.94	
9/11	21:0	HEEL	10.12	1.7210	17.42	3610.52

Table 7.1 Cont'd

..... ACCOUNTABILITY VESSEL						
DATE	HOUR	BATCH NAME	VOLUME (L)	CONCENTRA- TION (G/L)	GROSS WEIGHT (G)	NET WEIGHT (G)
9/12	8: 0	GE1-005	2099.82	1.6900	3548.70	
9/12	10: 0	HEEL	10.12	1.6900	17.10	3531.59
9/13	1: 0	GE1-006	2646.58	1.4840	3927.52	
9/13	3: 0	HEEL	9.59	1.4840	14.23	3913.29
9/14	3: 0	GE1-007	2169.70	1.4790	3208.99	
9/14	5: 0	HEEL	10.12	1.4790	14.97	3194.02
9/15	5: 0	GE1-008	2621.92	1.4570	3820.14	
9/15	8: 0	HEEL	10.12	1.4570	14.74	3805.39
9/16	11: 0	GE1-009	1794.58	1.6510	2962.85	
9/16	13: 0	HEEL	10.12	1.6510	16.71	2946.14
9/16	22: 0	GE1-010	2062.82	1.8370	3789.40	
9/17	1: 0	HEEL	10.12	1.8370	18.59	3770.81
9/17	13: 0	GE1-011	2042.26	1.7460	3565.79	
9/17	15: 0	HEEL	9.59	1.7460	16.74	3549.04
9/18	1: 0	GE1-012	1916.73	1.7250	3306.36	
9/18	2: 0	HEEL	10.12	1.7250	17.46	3288.90
9/18	14: 0	GE1-013	2108.04	1.5200	3204.22	
9/18	16: 0	HEEL	10.12	1.5200	15.38	3188.84
9/19	5: 0	GE1-014	2264.26	1.7390	3937.55	
9/19	9: 0	HEEL	10.12	1.7390	17.60	3919.95
9/20	1:29	GE1-014	1652.08	0.7310	1207.67	
9/20	6:18	HEEL	10.65	0.7310	7.79	1199.89
9/20	24: 0	GE1-014	1668.36	0.1700	283.62	
9/20	24: 0	HEEL	10.12	0.1700	1.72	281.90
9/21	15:15	GE1-014	1220.48	0.0480	58.58	
9/21	16:32	HEEL	10.12	0.0480	0.49	58.10
9/22	7:30	GE1-014	1485.14	0.0414	61.48	
9/22	8:50	HEEL	10.12	0.0414	0.42	61.07
10/13	21: 0	MI1-1,2	2827.47	0.8820	2493.83	
10/13	22: 0	HEEL	10.65	0.8820	9.39	2484.44
10/14	18: 0	MI1-003	1700.94	1.0900	1854.02	
10/14	19: 0	HEEL	10.12	1.0900	11.03	1842.99
10/15	3: 0	MI1-004	1696.86	1.0490	1780.01	
10/15	6: 0	HEEL	10.12	1.0490	10.62	1769.39
10/15	17: 0	MI1-005	1607.29	0.9920	1594.43	
10/15	17: 0	HEEL	10.12	0.9920	10.04	1584.39
10/16	4: 0	MI1-006	1806.80	1.0610	1917.01	
10/16	14: 0	HEEL	10.12	1.0610	10.74	1906.28
10/17	6: 0	MI1-007	1969.67	1.0330	2034.67	
10/17	7: 0	HEEL	10.12	1.0330	10.45	2024.22
10/21	19: 0	MI1-008	1692.79	0.9970	1687.71	
10/21	20: 0	HEEL	10.12	0.9970	10.09	1677.62
10/22	14: 0	MI1-009	1639.86	1.1780	1931.76	
10/22	14: 0	HEEL	10.12	1.1780	11.92	1919.83
10/22	23: 0	MI1-010	1770.15	1.2430	2200.30	
10/23	4: 0	HEEL	10.12	1.2430	12.58	2187.72
10/23	11: 0	MI1-011	1578.79	1.2600	1989.28	
10/23	12: 0	HEEL	10.12	1.2600	12.75	1976.52
10/23	23: 0	MI1-012	1782.37	1.1930	2126.37	
10/24		HEEL	10.12	1.1930	12.07	2114.29

Table 7.1 Cont'd

..... ACCOUNTABILITY VESSEL						
DATE	HOUR	BATCH NAME	VOLUME (L)	CONCENTRATION (G/L)	GROSS WEIGHT (G)	NET WEIGHT (G)
10/24	12: 0	MI1-013	1798.66	1.1330	2037.88	
10/24	13: 0	HEEL	10.12	1.1330	11.47	2026.42
10/25	8: 0	MI1-014	2025.82	1.0740	2175.73	
10/25	9: 0	HEEL	10.12	1.0740	10.87	2164.86
10/25		OTHERS	240.00	0.0183	4.39	
10/25		HEEL	0.0	0.0	0.0	4.39
10/26	7: 0	MI1-015	1700.94	1.0470	1780.88	
10/26	8: 0	HEEL	10.12	1.0470	10.60	1770.29
10/26	22: 0	MI1-016	1831.23	1.1070	2027.17	
10/26	23: 0	HEEL	10.12	1.1070	11.20	2015.97
10/27	9: 0	MI1-017	1831.23	1.1470	2100.42	
10/27	10: 0	HEEL	10.12	1.1470	11.61	2088.81
10/27		MI1-018	1757.94	1.1650	2048.00	
10/27		HEEL	10.12	1.1650	11.79	2036.21
10/28	13: 0	MI1-019	1823.09	1.1190	2040.04	
10/28	14: 0	HEEL	10.12	1.1190	11.32	2028.71
10/29	2: 0	MI1-020	1672.43	1.1930	1995.21	
10/29	3: 0	HEEL	10.12	1.1930	12.07	1983.14
10/29	13: 0	MI1-021	1749.80	1.1380	1991.27	
10/29	14: 0	HEEL	9.59	1.1380	10.91	1980.36
10/30	1: 0	MI1-022	1762.01	1.1020	1941.74	
10/30	2: 0	HEEL	9.59	1.1020	10.57	1931.17
10/30	14: 0	MI1-023	1912.66	1.0550	2017.86	
10/30	15: 0	HEEL	9.59	1.0550	10.12	2007.74
10/31	0: 0	MI1-024	1684.65	1.0700	1802.58	
10/31	1: 0	HEEL	9.59	1.0700	10.26	1792.31
10/31	15: 0	MI1-025	1904.52	1.1520	2194.01	
10/31	16: 0	HEEL	9.59	1.1520	11.05	2182.96
11/ 1	18: 0	MI1-026	1766.08	1.0230	1806.70	
11/ 1	19: 0	HEEL	10.12	1.0230	10.35	1796.35
11/ 2	8: 0	MI1-027	1871.95	1.0860	2032.94	
11/ 2	9: 0	HEEL	9.59	1.0860	10.41	2022.52
11/ 2	21: 0	MI1-028	1859.73	1.1140	2071.74	
11/ 2	22: 0	HEEL	10.12	1.1140	11.27	2060.47
11/ 3	12: 0	MI1-029	1937.09	1.1180	2165.67	
11/ 3	13: 0	HEEL	9.59	1.1180	10.72	2154.94
11/ 4	6: 0	MI1-030	1977.81	0.9460	1871.01	
11/ 4	7: 0	HEEL	10.12	0.9460	9.57	1861.43
11/ 5	13: 0	MI1-031	2021.71	1.0060	2033.84	
11/ 5	16: 0	HEEL	10.12	1.0060	10.18	2023.66
11/ 6	13: 0	MI1-032	2210.82	0.9540	2109.12	
11/ 6	15: 0	HEEL	10.12	0.9540	9.65	2099.47
11/ 9		MI1-032	1798.66	0.1400	251.81	
11/ 9		HEEL	0.0	0.0	0.0	251.81
11/11	1: 0	MI1-033	1847.52	0.9710	1793.94	
11/11	5: 0	HEEL	10.12	0.9710	9.83	1784.12
11/11	13: 0	MI1-034	1721.29	1.1200	1927.84	
11/11	15: 0	HEEL	9.59	1.1200	10.74	1917.10
11/12	3: 0	MI1-035	1847.52	1.0840	2002.71	
11/12	5: 0	HEEL	9.59	1.0840	10.40	1992.32

Table 7.1 Cont'd

..... ACCOUNTABILITY VESSEL						
DATE	HOUR	BATCH NAME	VOLUME (L)	CONCENTRATION (G/L)	GROSS WEIGHT (G)	NET WEIGHT (G)
11/12	14: 0	MI1-036	1770.15	1.0940	1936.54	
11/12	16: 0	HEEL	9.59	1.0940	10.49	1926.05
11/13	13: 0	MI1-037	1753.87	1.1120	1950.30	
11/13	14: 0	HEEL	10.12	1.1120	11.25	1939.05
11/14	11: 0	MI1-038	1900.45	1.0440	1984.07	
11/14	15: 0	HEEL	9.59	1.0440	10.01	1974.06
11/15	8: 0	MI1-039	1933.02	0.9480	1832.50	
11/15	11: 0	HEEL	9.59	0.9480	9.09	1823.41
11/16	9: 0	MI1-040	1717.22	1.1340	1947.33	
11/16	10: 0	HEEL	10.12	1.1340	11.48	1935.85
11/16	18: 0	MI1-041	1664.29	1.1650	1938.90	
11/16	20: 0	HEEL	9.59	1.1650	11.17	1927.73
11/17	17: 0	MI1-042	2445.14	1.0430	2550.28	
11/17	19: 0	HEEL	10.12	1.0430	10.56	2539.73
11/18		MI1-042	963.96	0.2046	197.23	
11/18		HEEL	9.59	0.2046	1.96	195.26
11/19		MI1-042	1220.48	0.0799	97.52	
11/19		HEEL	9.59	0.0799	0.77	96.75
11/19		MI1-042	1061.68	0.0512	54.36	
11/19		HEEL	10.12	0.0512	0.52	53.84
11/20		MI1-042	1163.48	0.0380	44.21	
11/20		HEEL	9.59	0.0380	0.36	43.85
11/20		MI1-042	1558.43	0.0	0.0	
11/20		HEEL	10.12	0.0	0.0	0.0
						276609.60

Table 7.2 Plutonium Product Accounting Data of MBA2 in C-1 and C-2 Campaigns

..... OUT FROM 266V23						
DATE	HOUR	BATCH NAME	VOLUME (L)	CONCENTRATION (G/L)	GROSS WEIGHT (G)	NET WEIGHT (G)
4/29	1:58		33.94	184.1000	6248.35	
4/29	2:23	HEEL	2.49	184.1000	458.41	5789.94
4/30	19: 0		33.07	216.5000	7159.65	
4/30	19:25	HEEL	2.67	216.5000	578.05	6581.60
5/ 4	9:55		32.56	220.3000	7172.97	
5/ 4	10: 3	HEEL	2.60	220.3000	572.78	6600.19
5/ 6	18:16		34.42	219.1000	7541.42	
5/ 6	18:32	HEEL	2.66	219.1000	582.81	6958.62
5/ 8	22:48		33.13	215.6000	7142.83	
5/ 8	23:13	HEEL	2.61	215.6000	562.72	6580.11
5/10	14:35		33.00	169.4000	5590.20	
5/10	14:50	HEEL	3.01	169.4000	509.89	5080.31
5/25	17: 5		36.15	185.1000	6691.36	
5/25	19:23	HEEL	2.16	185.1000	399.82	6291.55
5/27	14:20		43.46	160.1000	6957.95	
5/27	14:30	HEEL	2.64	160.1000	422.66	6535.28
5/29	14:45		38.24	183.8000	7028.51	
5/29	15:13	HEEL	7.56	183.8000	1389.53	5638.98
5/31	14:10		43.64	182.1000	7946.84	
5/31	14:20	HEEL	2.74	182.1000	498.95	7447.89
6/ 2	15:25		31.82	202.8000	6453.10	
6/ 2	16:33	HEEL	2.70	202.8000	547.56	5905.54
6/ 5	14:13		34.42	191.8000	6601.76	
6/ 5	14:50	HEEL	1.98	191.8000	379.76	6221.99
6/ 6	16:30		32.52	217.4000	7069.85	
6/ 6	17:54	HEEL	2.09	217.4000	454.37	6615.48
6/ 8	14:56		31.48	227.6000	7164.85	
6/ 8	15:13	HEEL	3.00	227.6000	682.80	6482.05
6/ 9	19: 0		31.81	215.7000	6861.42	
6/ 9	19:23	HEEL	2.05	215.7000	442.18	6419.23
6/11	15:35		35.50	221.7000	7870.35	
6/11	15:50	HEEL	2.09	221.7000	463.35	7407.00
6/12	15:30		32.66	210.6000	6878.20	
6/12	22:59	HEEL	1.98	210.6000	416.99	6461.21
6/14	14:11		35.49	208.1000	7385.47	
6/14	14:55	HEEL	2.36	208.1000	491.12	6894.35
6/16	17:55		34.81	210.3000	7320.54	
6/16	18:45	HEEL	2.56	210.3000	538.37	6782.17
6/18	14:15		32.49	219.1000	7118.56	
6/18	14:54	HEEL	2.47	219.1000	541.18	6577.38
6/20	18:21		31.57	247.3000	7807.26	
6/20	18:36	HEEL	2.17	247.3000	536.64	7270.62
6/22	13:35		32.20	226.9000	7306.18	
6/22	14: 5	HEEL	3.14	226.9000	712.47	6593.71
6/23	18: 5		33.64	222.5000	7484.90	
6/23	18:15	HEEL	2.11	222.5000	469.47	7015.42
6/26	14:40		29.38	153.8000	4518.64	
6/26	15: 3	HEEL	2.28	153.8000	350.66	4167.98
9/12	17:30		32.64	177.1000	5780.54	
9/12	17:39	HEEL	1.47	177.1000	260.34	5520.21

Table 7.2 Cont'd

..... OUT FROM 266V23						
DATE	HOUR	BATCH NAME	VOLUME (L)	CONCENTRA- TION (G/L)	GROSS WEIGHT (G)	NET WEIGHT (G)
9/13	10:35		31.13	230.2000	7166.13	
9/13	11: 0	HEEL	2.41	230.2000	554.78	6611.34
9/15	14:30		36.49	218.9000	7987.66	
9/15	16:10	HEEL	4.65	218.9000	1017.88	6969.78
9/17	14:55		38.65	192.1000	7424.66	
9/17	15:35	HEEL	2.26	192.1000	434.15	6990.52
9/18	18:50		32.42	213.5000	6921.67	
9/18	19:30	HEEL	2.31	213.5000	493.18	6428.48
9/20	11:24		35.05	220.3000	7721.51	
9/20	11:44	HEEL	1.33	220.3000	293.00	7428.52
9/21	15:48		32.26	259.7000	8377.92	
9/21	15:50	HEEL	2.49	259.7000	646.65	7731.27
10/ 3	14:55		36.92	133.2000	4917.74	
10/ 3	15:50	HEEL	3.24	133.2000	431.57	4486.18
10/23	18: 0		41.15	163.5000	6728.02	
10/23	18:29	HEEL	1.92	163.5000	313.92	6414.10
10/24	18: 0		33.09	220.0000	7279.80	
10/24	18:30	HEEL	1.22	220.0000	268.40	7011.40
10/27	14:45		42.22	159.4000	6729.87	
10/27	15:30	HEEL	2.30	159.4000	366.62	6363.25
10/28	12: 5		39.20	153.2000	6005.44	
10/28	12:22	HEEL	2.13	153.2000	326.32	5679.12
10/30	10:20		32.60	233.5000	7612.10	
10/30	10:37	HEEL	3.42	233.5000	798.57	6813.53
10/31	15: 5		34.68	231.0000	8011.08	
10/31	15:20	HEEL	1.88	231.0000	434.28	7576.80
11/ 3	6:13		33.02	235.3000	7769.61	
11/ 3	6:20	HEEL	2.13	235.3000	501.19	7268.42
11/ 5	14:40		32.27	220.5000	7115.53	
11/ 5	15: 0	HEEL	2.17	220.5000	478.48	6637.05
11/10	13:30		31.86	196.5000	6260.49	
11/10	14: 0	HEEL	2.30	196.5000	451.95	5808.54
11/14	18:59		32.33	213.5000	6902.45	
11/14	19:40	HEEL	2.36	213.5000	503.86	6398.59
11/17	15:20		37.15	198.6000	7377.99	
11/17	16: 8	HEEL	2.01	198.6000	399.19	6978.80
11/19	17:43		31.79	219.8000	6987.44	
11/19	18: 2	HEEL	2.44	219.8000	536.31	6451.13
						285885.65

Table 7.3 Waste Accounting Data of MBA2 in C-1 and C-2 Campaigns

..... WASTE 3→4					
DATE	HOUR	BATCH NAME	VOLUME (L)	CONCENTRA- TION (G/L)	GROSS WEIGHT (G)
-----	-----	-----	-----	-----	-----
4/11			3180.00	0.0003	1.11
4/15			3400.00	0.0003	1.19
4/17			3200.00	0.0008	2.53
4/30			3390.00	0.0008	2.54
5/ 1			3390.00	0.0003	0.95
5/ 9			3300.00	0.0017	5.54
5/ 9			3400.00	0.0002	0.68
5/19			3500.00	0.0003	1.12
5/19			3210.00	0.0015	4.88
5/20			3500.00	0.0007	2.31
5/27			3260.00	0.0010	3.29
5/28			3320.00	0.0005	1.83
6/ 8			3350.00	0.0003	0.87
6/17			3300.00	0.0001	0.20
6/23			3230.00	0.0036	11.60
6/24			3530.00	0.0003	0.99
7/ 2			3390.00	0.0001	0.20
7/ 7			2500.00	0.0000	0.12
7/ 8			3660.00	0.0035	12.92
7/12			3240.00	0.0007	2.30
7/16			2900.00	0.0001	0.17
7/22			2930.00	0.0013	3.66
8/29			3.25	3.1800	10.33
9/ 3			3.35	0.0400	0.13
9/13			3.38	0.0500	0.17
9/17			3.35	0.7900	2.65
9/21			3.15	0.0300	0.09
9/26			3.11	0.5300	1.65
9/27			3.26	1.2500	4.07
10/21			3.41	0.3400	1.16
10/22			3.39	0.2400	0.81
10/23			3.45	0.0400	0.14
10/23			3.46	0.4300	1.49
10/26			2.58	0.4000	1.03
10/30			3.38	1.7400	5.88
11/ 9			3.35	0.3400	1.14
11/ 9			3.02	0.7500	2.26
11/19			3.35	3.2900	11.02
11/23			3.19	1.8000	5.74
11/26			3.11	0.1500	0.47
12/ 2			3.30	0.0200	0.07
12/ 3			2.70	2.9700	8.02
10/14			0.58	0.0	0.0
10/28			0.76	0.0700	0.05
11/ 8			1.15	0.0	0.0
11/14			0.67	0.1900	0.13
11/29			1.06	0.0	0.0
11/30			1.88	0.0	0.0
					119.53

Table 7.4 In-process Inventory Data in C-1 Campaign

In-process Inventory	Sampling Time and Items	Measurement Points						Total Inventory
		Q1	D1	D2	D3	D4	Q9	
1* 80/03/03	Time Volume (L) Conc. (g/L) weight (g)				52.6 0.11 5.8		45.6 43.1 1965.4	
2 80/04/28 (2:30)	Time Volume (L) Conc. (g/L) weight (g)		3:10 2903.9 0.87 2526.4	2:50 2070.1 0.21 434.7	2:50 773.8 0.81 626.8	2:55 78.3 7.63 597.3	9:25 33.9 184.1 6248.4	10433.5
3 80/05/08 (1:00)	Time Volume (L) Conc. (g/L) weight (g)		1:20 1199.8 0.92 1103.8	1:30 2002.6 0.26 520.7	1:25 401.0 0.94 376.9	1:20 107.8 13.70 1476.6	1:15 33.1 215.6 7142.8	10620.8
4 80/05/28 (22:00)	Time Volume (L) Conc. (g/L) Whight (g)		22:40 2441.5 1.12 2734.5	22:45 1854.6 0.36 667.7	22:30 593.9 0.77 457.3	22:15 87.8 8.04 706.0	23:40 38.2 183.8 7028.5	11594.0
5 80/06/06 (2:00)	Time Volume (L) Conc. (g/L) weight (g)		2:05 1893.4 1.27 2404.7	1:55 2599.1 0.30 779.7	1:53 606.6 1.04 630.9	1:55 33.6 10.20 342.6	6:00 32.5 217.4 7069.9	11227.8
6 80/06/10 (18:00)	Time Volume (L) Conc. (g/L) weight (g)		18:15 3181.9 1:30 4136.4	18:00 1849.5 0.45 832.3	18:13 530.2 1.05 556.7	18:10 43.9 14.90 654.7	23:00 35.5 221.7 7870.4	14050.5
7 80/06/17 (15:00)	Time Volume (L) Conc. (g/L) weight (g)		15:30 2964.3 1.20 3557.1	15:05 1826.3 0.29 529.6	15:10 377.8 1.05 396.7	15:05 90.7 14.20 1288.1	15:30 32.5 228.0 7407.2	13178.7
8* 80/08/01	Time Volume (L) Conc. (g/L) weight (g)				142.7 0.28 40.0		34.1 7.72 263.6	

Conc. : Concentration of Plutonium.

* : Data for March 3 and August 1 are obtained by Clean-out PITs.

Table 7.5 In-process Inventory Data in C-2 Campaign

In-process Inventory	Sampling Time and Items	Measurement Points						Total Inventory
		Q1	D1	D2	D3	D4	Q9	
1* 80/08/01	Time Volume (L) Conc. (g/L) weight (g)				142.8 0.28 40		34.1 7.72 264	
2 80/09/12 (2:00)	Time Volume (L) Conc. (g/L) weight (g)		7:45 1890.0 1.76 3326	2:00 1957.0 0.57 1115	2:10 482.0 1.39 670	4:10 108.3 12.70 1375	4:30 32.6 177.1 5781	12268
3 80/09/16 (20:00)	Time Volume (L) Conc. (g/L) Whight (g)		21:05 607.0 1.85 1123	20:20 1803.0 0.53 956	20:10 377.0 0.82 309	22:00 38.1 10.80 411	2:00 32.6 192.1 7515	10314
4 80/10/17 (11:30)	Time Volume (L) Conc. (g/L) weight (g)		1187.0 ⁺ 1.03 ⁺ 1226	11:40 1780.0 0.34 605	11:25 423.1 1.01 427	18:40 76.0 13.10 996	15:32 41.2 163.5 6729	9984
5 80/10/28 (5:00)	Time Volume (L) Conc. (g/L) weight (g)		2227.0 ⁺ 1.15 ⁺ 2554	5:00 1780.0 0.37 658	5:00 333.0 1.15 383	5:10 98.7 15.30 1510	7:30 40.1 153.2 6139	11245
6 80/11/04 (23:00)	Time Volume (L) Conc. (g/L) weight (g)		2562.0 ⁺ 1.02 ⁺ 2608	23:05 1724.0 0.18 310	23:00 405.0 0.63 255	23:15 87.4 9.29 812	2:15 32.8 220.5 7239	11225
7 80/11/13 (18:30)	Time Volume (L) Conc. (g/L) weight (g)		3092.0 ⁺ 1.09 ⁺ 3376	18:10 1810.0 0.20 362	18:55 462.5 0.43 199	19:35 96.7 9.25 894	20:22 33.7 213.5 7186	12018
8 80/11/18 (23:15)	Time Volume (L) Conc. (g/L) weight (g)		819.0 ⁺ 0.02 ⁺ 16	23:15 1895.0 0.06 114	23:15 436.0 0.55 240	23:15 95.7 11.30 1081	9:48 31.9 219.8 7005	8456
9* 80/12/09	Time Volume (L) Conc. (g/L) weight (g)						44.5 130.1 5786	

Conc. : Concentration of Plutonium.

* : Data for August 1 and December 9 are obtained by Clean-out PITs

+ : Estimated Value.

Table 7.6 In-process Material Balance Data in C-1 and C-2 Campaigns

[Unit : g]

	NRTMBP	Inventory Taking		Input	Output	Waste	MUF _d	G _{MUFd}	CUMUF	σ _{CUMUF}	
		Date (Time)	Inventory								
C-1 Campaign	1	BI	3/03	7662	6611	0	5	3834	148	3834	148
		EI	4/28 (2:30)	10433							
	2	BI	"	"	24708	25930	3	-1413	246	2422	266
		EI	5/08 (1:00)	10621							
	3	BI	"	"	24772	24487	20	- 708	244	1714	430
		EI	5/28 (22:00)	11594							
	4	BI	"	"	27232	25214	0	2384	260	4097	602
	EI	6/06 (2:00)	11228								
5	BI	"	"	20392	19517	1	-1949	246	2148	748	
	EI	6/10 (18:00)	14050								
6	BI	"	"	25163	27545	0	-1511	285	638	917	
	EI	6/17 (15:00)	13179								
7	BI	"	"	16471	31625	32	-4422	339	-3785	1079	
	EI	8/01	2416								
C-2 Campaign	8	BI	"	"	12997	0	10	3135	301	- 650	1119
		EI	9/12 (2:00)	12268							
	9	BI	"	"	17390	19101	0	243	231	- 407	1235
		EI	9/16 (20:00)	10314							
	10	BI	"	"	30930	33065	8	-1813	245	-2220	1391
		EI	10/17 (11:30)	9984							
	11	BI	"	"	21983	19789	5	929	220	-1291	1399
		EI	10/28 (5:00)	11245							
12	BI	"	"	23802	27338	6	-3521	255	-4813	1403	
	EI	11/04 (23:00)	11225								
13	BI	"	"	13934	12446	3	691	196	-4122	1408	
	EI	11/13 (18:30)	12018								
14	BI	"	"	10396	13377	0	581	196	-3541	1405	
	EI	11/18 (23:15)	8456								
15	BI	"	"	194	6451	25	-4116	125	-7657	1405	
	EI	12/09	6289								

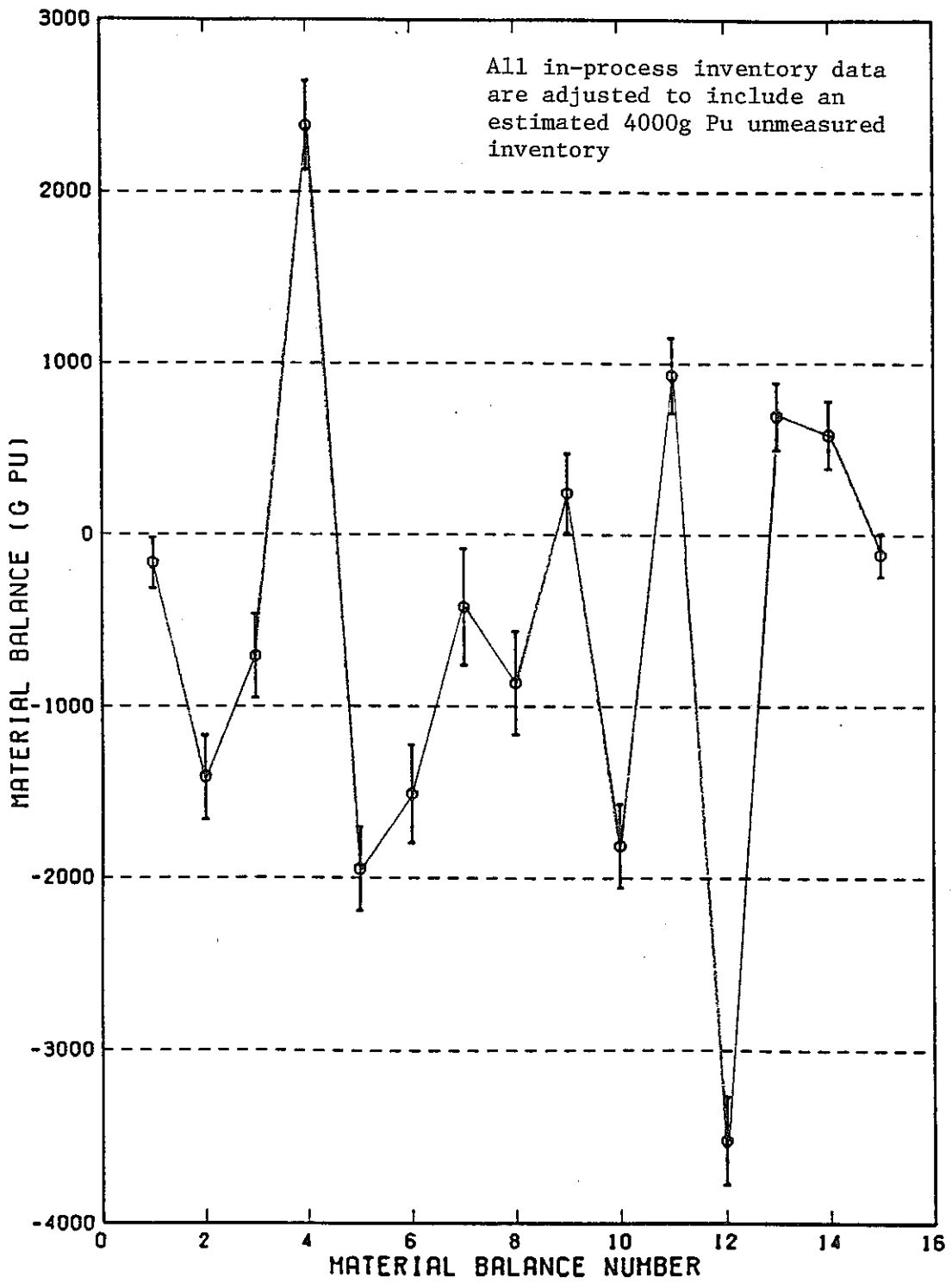

Fig. 7.1 Adjusted n.r.t. material balance (MUF_d) in C-1 and C-2 campaigns

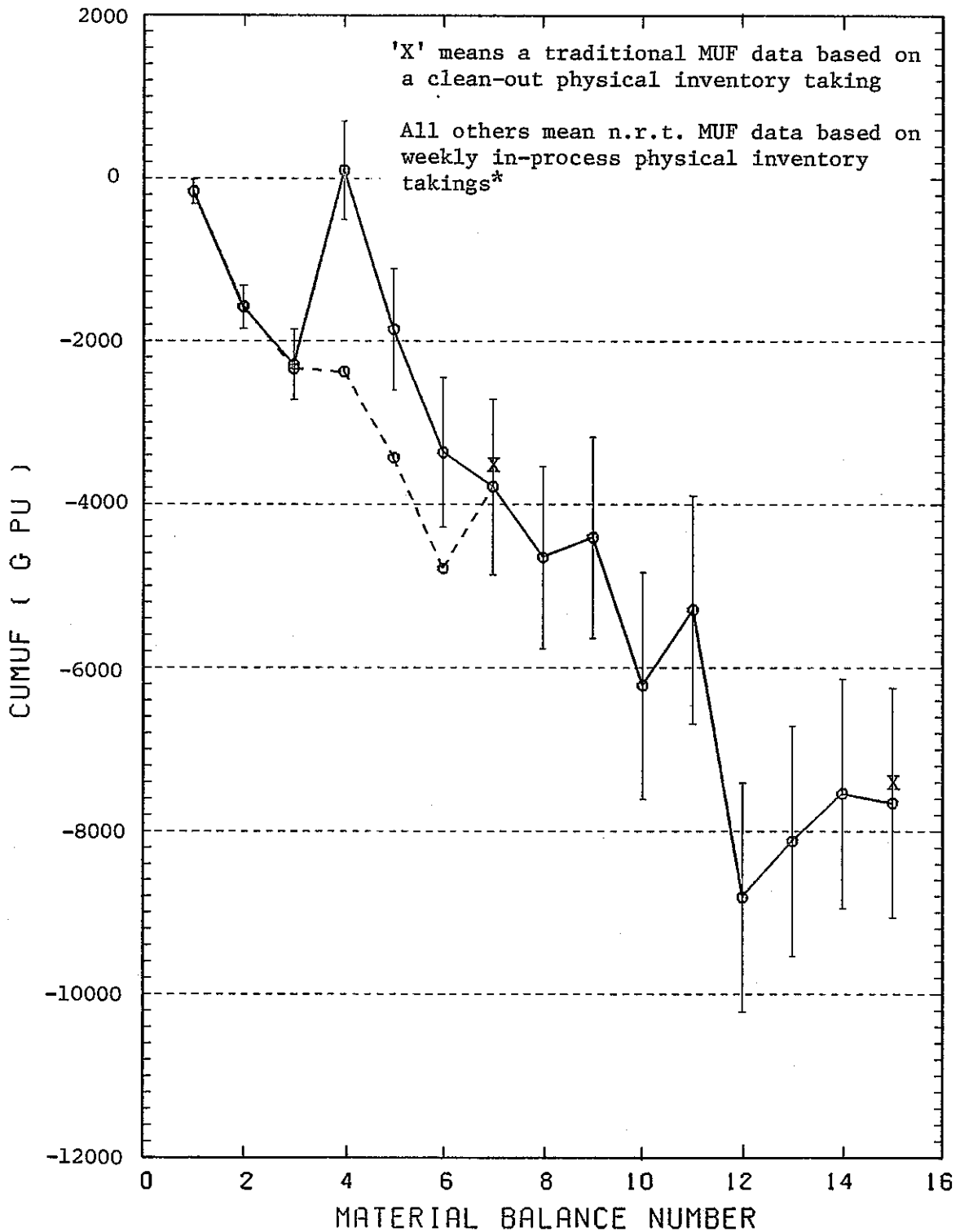

Fig. 7.2 CUMUF data based on adjusted MUF_d data in C-1 and C-2 campaigns

* All MUF data on a solid line are adjusted to include an estimated unmeasured inventory. Only the first MUF is affected.

All MUF data on a dotted line are corrected for fluctuation of the inventory in the mixer-settler systems and adjusted to include an estimated unmeasured inventory other than that in the mixer-settler system.

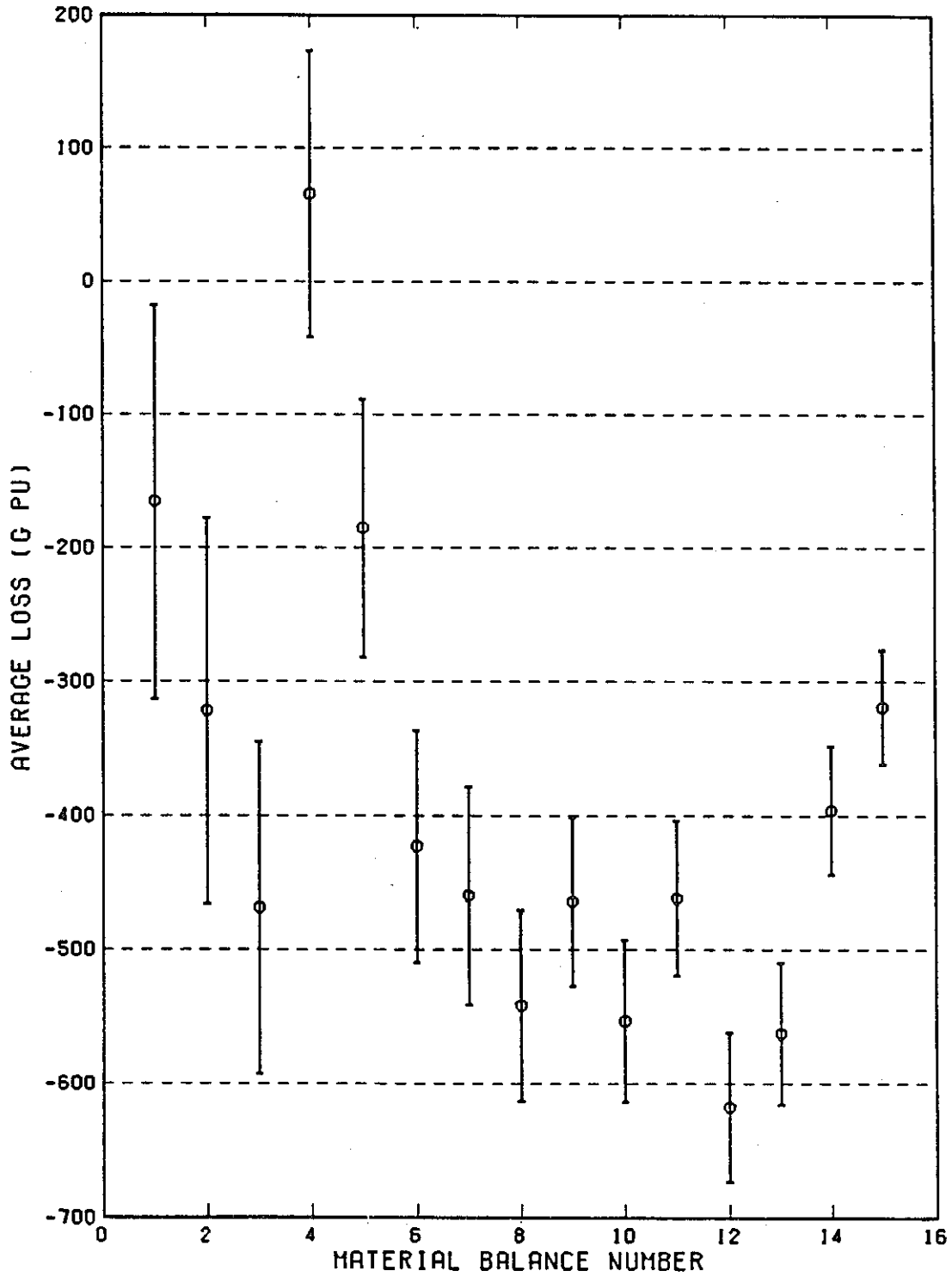

Fig. 7.3 Average loss (uniform diversion) based on the two-state Kalman filter estimate in C-1 and C-2 campaigns.

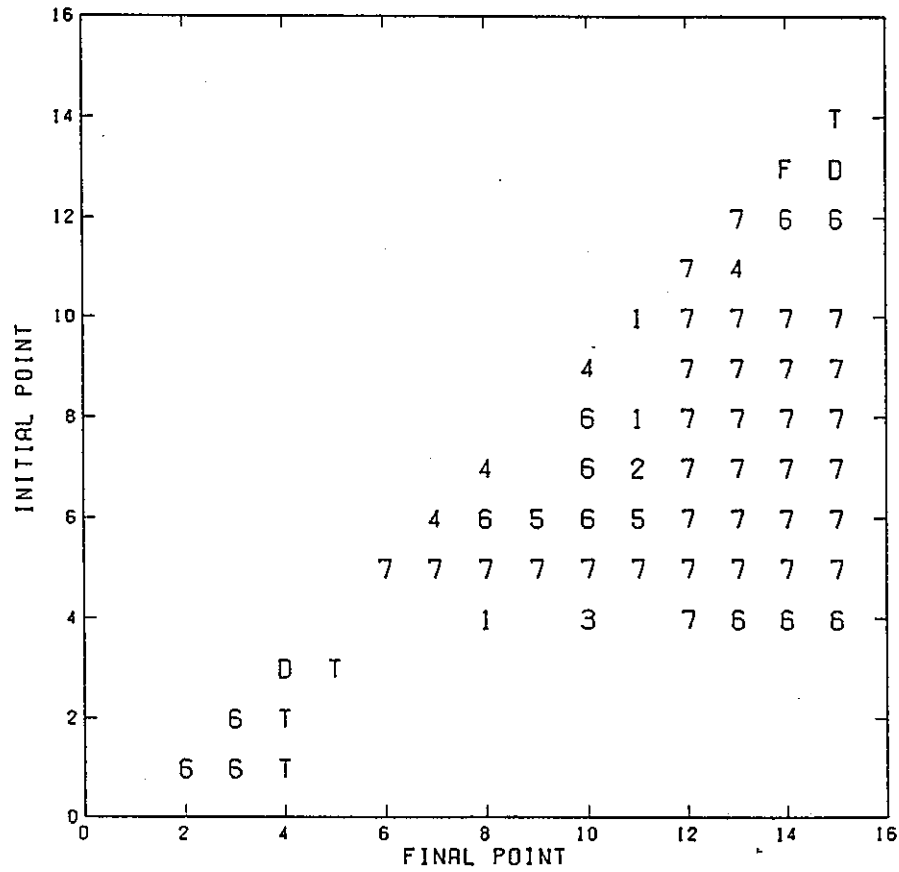

Fig. 7.4 Alarm-Sequence Chart based on CUMUF Tests

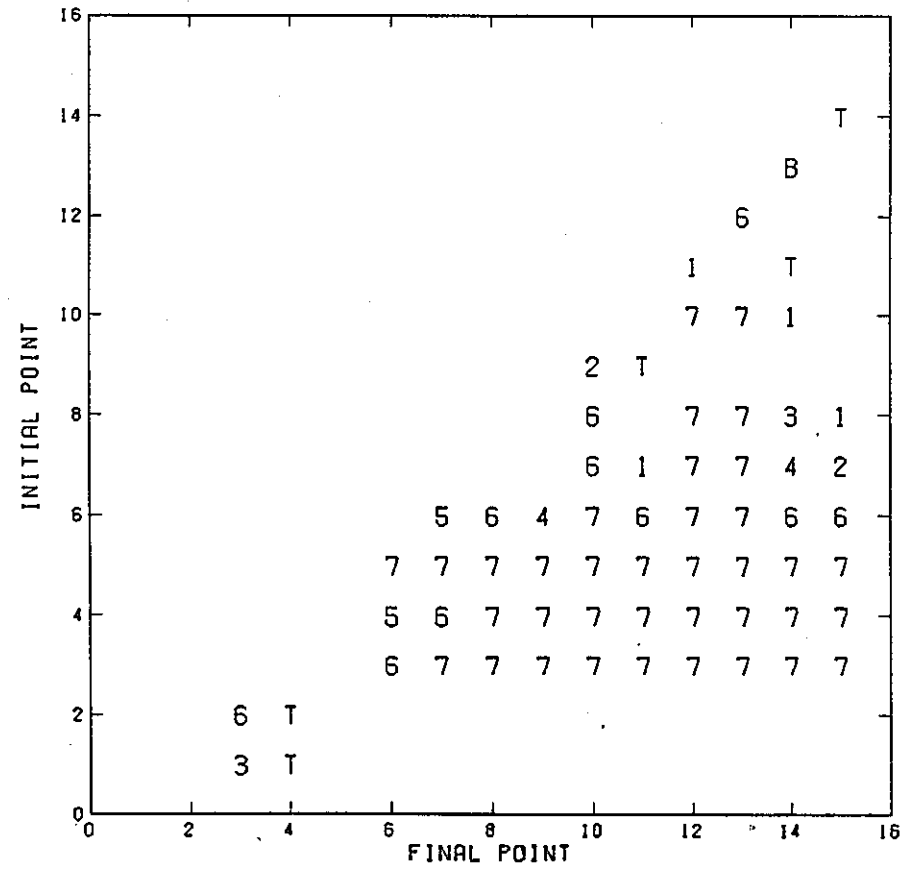

Fig. 7.5 Alarm-Sequence Chart based on Uniform Diversion Tests

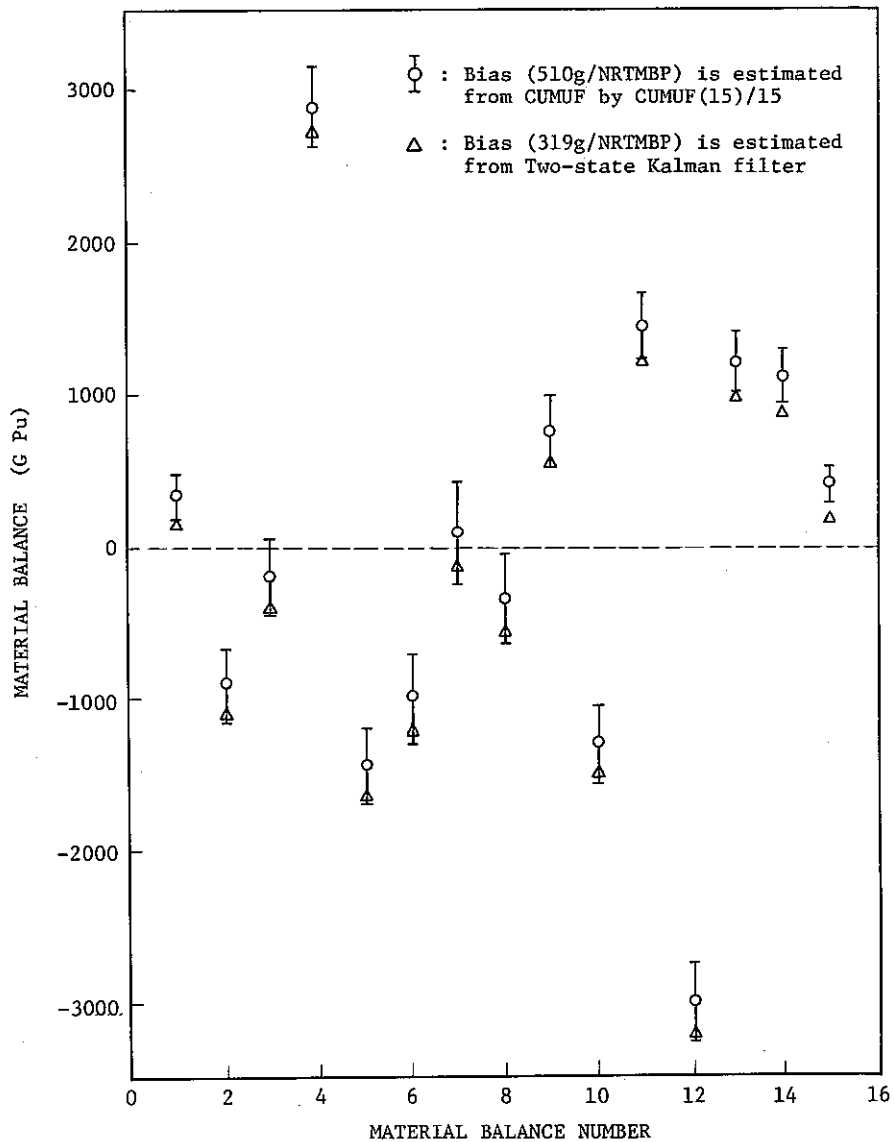

Fig. 7.6 MUF_d Corrected for Biases of Different Estimates.

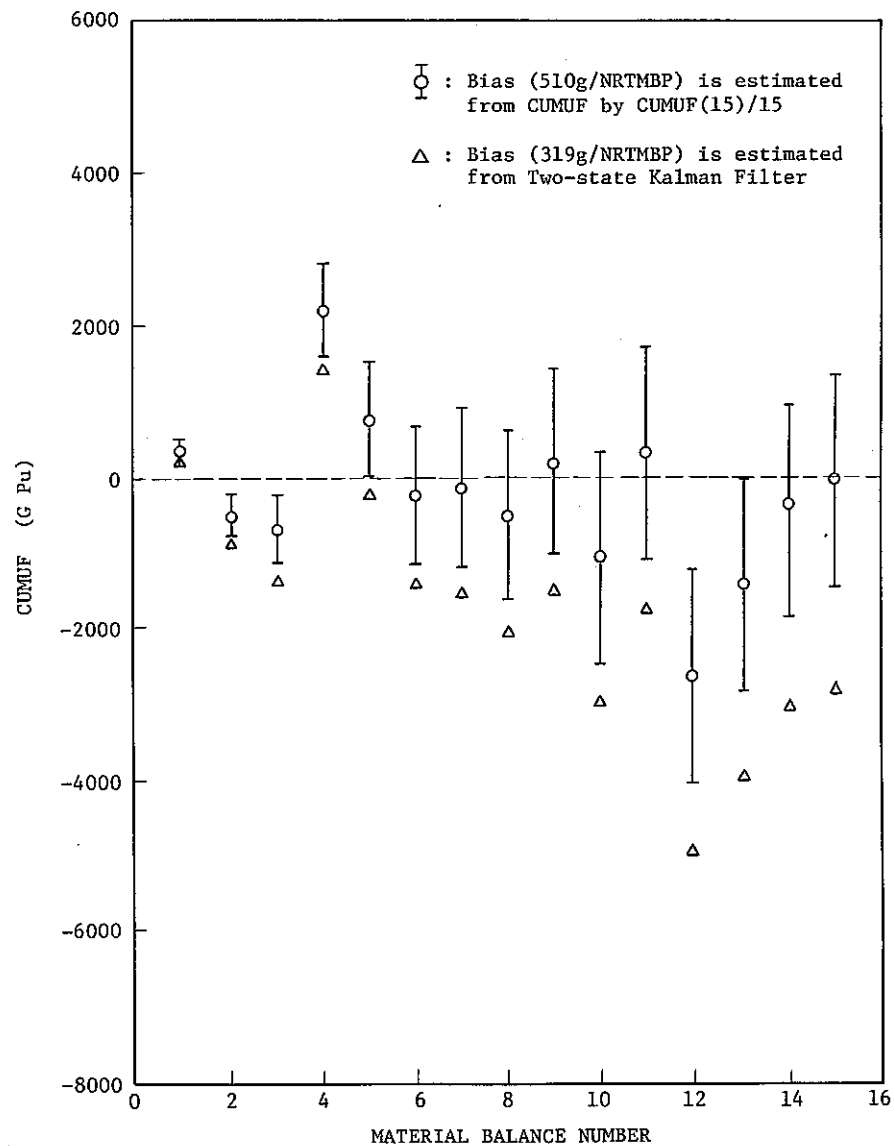

Fig. 7.7 CUMUF Based on MUF_d Corrected for Biases of Different Estimates.

8. RECOMMENDATIONS AND CONCLUSIONS

8.1 Recommendations for Future Work

8.1.1 General

The feasibility study has shown that near-real-time materials accountancy for the PNC-Tokai reprocessing facility is feasible, and that indeed it would require no measurements not routinely performed for process control purposes. It has also shown that if the system is implemented using weekly in-process inventories of the four buffer storage tanks the detection sensitivity should meet all IAEA guidelines.

The field test data currently available, however, are not sufficient to permit any estimation of the ultimate detection sensitivity of n.r.t. accountancy for the PNC-Tokai facility, especially considering the existing measurement bias.

8.1.2 Development of Integrated Safeguards System

Most of the work to date has been related to the use of near-real-time materials accountancy in the process MBA. To be of maximum value for IAEA safeguards, this concept must be combined into an integrated safeguards system which considers all material balance areas, and which combines near-real-time materials accountancy with containment-surveillance measures in some optimum manner. Such a system has been prepared in conceptual outline; many details still require study and development.

In the spent fuel receiving and storage area the conceptual outline suggests that IAEA inspectors would observe and verify, on a 100% basis, all spent fuel receipts. Either photographic or video surveillance would be used to ensure that there were no undeclared receipts or shipments of spent fuel, and perhaps also to monitor the spent fuel storage area itself. Primary reliance for the latter, however, would be placed in a mini-computer X-Y crane position monitoring system. The minicomputer would store safeguards-relevant information related to stored spent fuel, and would record storage locations in terms of an X-Y grid of the entire area capable of being traversed by the spent fuel handling crane. When spent fuel was transferred to the mechanical cell for processing, the computer

would note, from crane movements and from crane weight loads, the identity of the fuel transferred, thus eliminating the need for inspector observation and verification of these transfer activities. Such a computer monitor system does not now exist, and needs to be developed and studied.

In the process MBA primary reliance would be on the near-real-time materials accountancy system already developed. As a supportive system, a limited computer monitoring system would be developed. This computerized monitoring system, however, would not need to be nearly as extensive as some that have been suggested. This is because, although there are innumerable ways in which plutonium might conceivably be diverted from the process MBA, virtually all diversion paths necessarily affect either the volume in one of the four buffer storage tanks or some other critical parameter closely associated with those tanks. It is believed, subject to further development and study, that it would be extremely difficult to devise a diversion mechanism which did not directly or indirectly affect one of those tanks in some observable manner.

TASTEX task I has already developed a monitoring system for the product storage area, which system presumably would be incorporated into the proposed integrated safeguards system more or less intact. Since that system largely deals only with solution volumes, however, a system of near-real-time materials accountancy based on periodic chemical sampling and analysis of the storage tanks would also be necessary.

8.1.3 Development of Improved Model for Estimation of Inventory Hold-up in Mixer-Settler Systems

As discussed in section 7.2.2, the validity of SEPHIS should be reviewed in comparison with PUBG using actual operating data, because SEPHIS assumes that contactors operate at mass transfer equilibrium. It therefore does not account for the effects of mass transfer rates, while PUBG does account for these effects. If the effects are significant, the difference in estimation of inventory may become a significant problem in determining the ultimate detection sensitivity of the proposed n.r.t. materials accountancy system.

It is expected that a simplified model to estimate the total Pu inventory in a mixer-settler system can be developed using aqueous feed and aqueous waste concentrations, and two constants which can be derived from PUBG modeling. This simplified model, if developed successfully, becomes a

very useful and effective tool for the n.r.t. accountancy system.

8.1.4 Investigation of Source of Measurement Bias across the Process MBA

The results of analysis of field test data in the C-1 and C-2 campaigns clearly show that there was a measurement bias across the process MBA. The source of this bias should be investigated as soon as possible in order to improve the reliability of the materials accountancy of the Tokai Plant.

8.2 Conclusions

The TASTEX task F work has shown that it might be feasible to apply near-real-time materials accountancy to the PNC-Tokai facility, that doing so could fulfill IAEA goals in terms of detection timeliness and sensitivity, and that by such a system impacts on normal facility operations could be minimized. It has also shown that it should be possible to develop and implement inspection procedures which could verify the near-real-time accountancy data for IAEA safeguards purposes, and that it should be possible to incorporate the near-real-time accountancy system into an integrated safeguards system for the entire facility.

Continuing activities are necessary, and are planned, in a number of areas. Minor modifications still appear to be necessary in the sequential decision analysis used to evaluate near-real-time accountancy data, particularly to accommodate an inspector-supplied estimate of the unmeasured in-process inventory. Both the study of IAEA verification procedures and the definition of an integrated safeguards system are incomplete, and require further study. Field testing as an aid in defining ultimate detection sensitivity.

Several problems have arisen in the course of the study which require further effort if near-real-time materials accountancy is to achieve its anticipated full potential. Specifically,

- (a) there is a need for an instrumental (NDA) measurement for input dissolver solutions,
- (b) there is a need to validate the PUBG model for solvent extraction system modeling, and to derive from it the simplified inventory estimation model needed for near-real-time accountancy and IAEA safeguards.

ACKNOWLEDGEMENTS

The authors wish to acknowledge the helpful suggestions and consultations of D.D. Cobb of LANL, especially with regard to improved mixer-settler contactor models. The authors are also very grateful to G.R. Keepin, J.P. Shipley, E.A. Hakkila, R.H. Augustson, R.J. Dietz, C.R. Hatcher, and others from the Safeguards Division of LANL for their cooperative work of the Task-F of TASTEX Programme and specifically for their stimulative discussion at several workshops held at LANL.

Thanks are to H. Okashita, H. Umezawa, H. Natsume, T. Tsujino, and S. Matsuura of JAERI for their frequent and helpful discussion.

It is a pleasure to acknowledge the continuous encouragement of H. Ishikawa of JAERI, K. Nakajima, H. Iwamoto (now IAEA), T. Koizumi, K. Higuchi, and H. Kawamoto of PNC and H. Yoshida of JAERI during this study.

The authors would like to express our appreciation to K. Matsumoto, Y. Asakura, K. Gonda, T. Shibata, and A. Kobe of PNC for their cooperative work in the various areas of Task-F and to other people of PNC who had been included in the special working group for the field test of the 10-day-detection-time model.

The authors wish to thank Taeko Suzuki, Kyoko Murata and T. Koyama of JAERI for their assistance in preparation of the manuscript.

REFERENCES

- 1) G. Hough, T. Shea, D. Tolchenkov: International Atomic Energy Agency: "Technical Criteria for The Application of IAEA Safeguards" IAEA-SM-231/112.
- 2) E.A. Hakkila, D.D. Cobb, H.A. Dayem, R.J. Dietz, E.A. Kern, E.P. Schelonka, J.P. Shipley, D.B. Smith, R.H. Augustson, J.W. Barnes: "Coordinated Safeguards for Materials Management in a Fuel Reprocessing Plant, Los Alamos Scientific Laboratory Report LA-6881, Vol.1 (September 1977).
- 3) E.A. Hakkila, J.W. Barnes, T.R. Canada, D.D. Cobb, S.T. Hsue, D.G. Langner, J.L. Parker, J.P. Shipley, D.B. Smith: Coordinated Safeguards for Materials Management in a Fuel Reprocessing Plant, II. Appendix, Los Alamos Scientific Laboratory Report LA-6881, Vol.II (September 1977).
- 4) John L. Jaech: "Statistical Methods in Nuclear Material Control", Exxon Nuclear Company (1973) TDI-26298.
- 5) UN Document A/6858, (October 1968).
- 6) See, for example, M. Wilrich and T. Taylor: "Nuclear Theft; Risks and Safeguards", Ballinger Publishing Company, Cambridge (1974).
- 7) K. Nakajima, T. Koizumi, N. Suyama and Y. Kishimoto: "Development of Safeguards Procedures for a Reprocessing Plant with Mechanical Head-end Mixer Settler Contactors Using a Purex Flowsheet" Final Report of IAEA Research Contract No. 796/RB (1971).
- 8) S.B. Watson and R.H. Rainey: "Modifications of the SEPHIS Computer Code for Calculating the Purex Solvent Extraction System", Oak Ridge National Laboratory Report ORNL-TM-5123 (December 1975).
- 9) Compiled by L.L. Lowry and R.H. Augustson.
Contributed by T.R. Canada, D.D. Cobb, J.P. Shipley and L.L. Lowry: "TASTEX T-F, Study of Selected Capabilities Needed to Apply DYMAG Principles to Safeguarding The Tokai Reprocessing Plant", LA-8070-MS.
- 10) D.D. Cobb, A.L. Beyerlein and L.E. Burkhurt: "In-Process Inventory Estimation for Pulsed Columns and Mixer-Settlers".