

本資料は 2001. 6. 6 日付けて登録区分、
変更する。

[技術情報室]

「軽水炉用」プルトニウム富化燃料のHBWR (第二次) 照射試験

(Ⅲ) IFA-529燃料集合体の照射データ中間報告

HBWR Irradiation Experiment for Plutonium Bearing "LWR-Type"
Fuel Rod (2nd)

(Ⅲ) Interim Report on Instrumental Data of IFA-529

1984年6月

動力炉・核燃料開発事業団

東海事業所

本資料の全部または一部を複写・複製・転載する場合は、下記にお問い合わせください。

〒319-1184 茨城県那珂郡東海村大字村松4番地49
核燃料サイクル開発機構
技術展開部 技術協力課

Inquiries about copyright and reproduction should be addressed to:
Technical Cooperation Section,
Technology Management Division,
Japan Nuclear Cycle Development Institute
4-49 Muramatsu, Tokai-mura, Naka-gun, Ibaraki, 319-1184
Japan

に
よ
知

© 核燃料サイクル開発機構 (Japan Nuclear Cycle Development Institute)
2001

「軽水炉用」プルトニウム富化燃料のHBWR(第二次)照射試験
 (Ⅲ) IFA-529燃料集合体の照射データ中間報告



HBWR Irradiation Experiment for Plutonium Bearing

"LWR-Type" Fuel Rod (2nd)

(Ⅲ) Interim Report on Instrumental Data of IFA-529

実施責任者 横内 洋二*

報告者 久保 稔** 安部 智之**

井坂 浩順***

期 間 1980年6月～1983年1月

目 的 軽水炉用プルトニウム富化燃料に関する第2次HBWR照射試験の照射データの
 中間報告

要 旨 本照射試験は、軽水炉へのプルトニウム利用技術開発の一環であり、ノルウェー
 国ハルデン炉(HBWR)を利用した試験としては、第1次試験(IFA-514)に続
 く、第2次試験である。本試験の目的は、軽水炉用プルトニウム燃料の照射特性の
 確認(混合転換法により製造された原料を用いた燃料を含む)及び照射パラメータ
 (ペレット-被覆管ギャップ)による照射挙動のちがいの把握である。さらに本試
 験により得られる照射中の計装データを用いて新型転換炉燃料設計用コードの信頼
 性向上を図ることができる。本報告は、昭和57年度までに得られたIFA-529の
 照射データをまとめたものである。

本集合体の照射は昭和55年6月30日から昭和58年1月2日まで約30ヶ月順調
 に照射が続けられており、昭和60年度まで照射する予定である。この照射期間中
 に記録した照射特性は以下の通りである。

最大集合体出力	245 kW
最大線出力	500 W/cm
最大燃焼度	14,133 MWd/t MOX
稼働率(稼働日数/照射日数)	47.4%

* プルトニウム燃料部設計開発課長

** プルトニウム燃料部設計開発課

*** 原子力技術(株)

目 次

1. 概 要	1
2. 照射条件	2
2.1 HBWR概要	2
2.2 照射位置	2
2.3 燃料棒と計装の配置	2
2.4 炉出力履歴	5
3. IFA-529 燃料集合体の設計概要	12
4. 燃料照射データ	15
4.1 計装データ処理	15
4.2 計装の状況	15
4.3 照射データ	15
5. 今後の照射計画	17
5.1 照射計画	17
5.2 データの解析・評価	17
6. 参考文献	19
付録1 IFA-529 各燃料棒の年別の線出力履歴（1980年度～1982年度）	
付録2 IFA-529 各燃料棒の月別の線出力履歴（1980年7月～1983年1月）	
付録3 IFA-529 の軸方向出力分布（1980年7月～1983年1月）	
付録4 IFA-529 計装データ	
～PF（燃料棒内圧）データ～ロッド1, ロッド2, ロッド3, ロッド4,	
ロッド5, ロッド6, ロッド8, ロッド10,	
ロッド12	
付録5 IFA-529 計装データ	
～EC（被覆管伸び）データ～ロッド7, ロッド9, ロッド10, ロッド11	
付録6 IFA-529 計装データ	
～EF（燃料スタック長伸び）データ～ロッド7, ロッド9, ロッド11	
付録7 IFA-529 計装データ	
～TF（燃料中心温度）データ～ロッド8, ロッド12	

1. 概 要

IFA-529は6本組の上下2クラスタ構造の計装付燃料集合体であり、軽水炉用プルトニウム燃料の照射特性の確認と、ATR燃料設計に用いる設計用計算コードの精度向上を目的としてハルデン炉にて照射されている。

照射は昭和55年6月30日から昭和58年1月2日までの約30ヶ月行われており、さらに昭和60年度まで照射される予定である。この期間に記録した最高線出力は500 W/cm (S 57.12.5)で、昭和58年1月2日におけるピークペレットの推定燃焼度は14,133 MWd/tMOXであった。

IFA-529燃料集合体は、上、下2段に配列した(2クラスタ)構造で、クラスタは短尺燃料(ペレットスタック長さ; 550 mm)6本その他、各構造材(センターチューブ、タイロッド、ケーブルチューブ)が同心円上に設置されている。このMOX燃料は以下のような特徴を持っている。

- (1) 燃料棒は軽水炉BWR 8×8タイプで、ペレットと被覆管のギャップをパラメータとした場合の機械的作用(PCMI)の調査ができる。
- (2) 混合転換法により製造される原料を用いた燃料の照射挙動上の確認をする。
- (3) 燃料棒は計装が取り付けられ、照射中の燃料挙動特性が解明できる。

上記の照射目的に従い、HBWRの照射試験条件を加味して、設計条件は次のように決められた。

- | | |
|------------------|-----------------------|
| (1) 燃料集合体出力 | 260 kW |
| (2) 最高燃料棒線出力 | 490 W/cm |
| (3) 最高燃料棒表面熱流束 | 124 W/cm ² |
| (4) 最終燃焼度(最高燃料棒) | 10,000 MWD/T |
| (5) 集合体冷却条件 | |
| (イ) 入口流速 | 0.3 m/s 以上 |
| (ロ) 流量 | 0.8 kg/s 以上 |

本報告書は、IFA-529燃料集合体の照射条件、照射履歴及び計装データをまとめたものである。

なお、本照射燃料の設計、製造については既に報告済である。^{1),2)}

2. 照射条件

2.1 HBWRの概要³⁾

HBWRは1959年、臨界に達した沸騰水型原子炉で、以来幾度かの改良を経て、現在に至っている。最近の炉心改良は、1983年初期に行なわれ、中性子束レベルを2～2.2倍に増やし、軽水動力炉と同じ中性子束条件を達成した。炉心燃料は60体であり、うち45体を計装付燃料とすることができる。以下にIFA-529の照射開始から、1983年1月2日までの主な運転条件を示す。

- | | |
|--------------|---|
| (1) 炉出力 | 最大 25 MW |
| (2) 冷却材圧力 | 34.4 ata |
| (3) 冷却材温度 | 240 °C |
| (4) 最大熱中性子束 | 約 0.5×10^{13} n/cm ² ・s |
| (5) 最大高速中性子束 | 約 0.5×10^{13} n/cm ² ・s |
| (6) 最大ガンマ束 | 0.5 W/g |
| (7) 炉心有効長 | 1,700 mm |

Fig. 2.1にHBWRの炉心の概要図を示す。

2.2 照射位置

IFA-529は1980年6月30日の原子炉起動時にFig. 2.2に示したように列4-0に装荷され、1983年1月2日までこの位置で照射された。

IFA-529燃料集合体の照射期間中の延べ稼働日数は434日で、延べ日数916日に対して47.4%の稼働率であった。HBWRの炉出力はIFA-529燃料集合体が照射された全期間について報告されていないが、定常状態で12～15 MWの範囲で運転されている。なお最大炉出力はTest Fuel Data Reportによると昭和57年3月24日の16.9 MWであった。1週間毎にまとめられた炉運転状況(炉出力及び冷却水温度)は、IFA-514燃料集合体の照射データ中間報告書⁴⁾にて報告済みである。

2.3 燃料棒と計装の配置

集合体内の燃料棒および計装の配置をFig. 2.3, 2.4に示す。また炉内計装を取付けたIFA-529燃料集合体の図面をFig. 2.5に示す。

燃料体は、天然ウラン粉末とプルトニウム粉末とを機械混合し、冷間成形後焼結したペレット「M.Bペレット」、硝酸ウランとの混合溶液をマイクロ波加熱法により直接脱硝後、焙焼・還元工程を経て処理した原料粉末と天然ウラン粉末とを機械混合・冷間成形後焼結したペレット「C.Pペレット」の2種類で、照射の目的に応じて、7種類のペレットが充填されている。次頁に燃料棒Noと計装の対応表を示す。また部材等の組合せをTable 2.1に示す。

燃 料 棒	ペレット種類*	上部計装	下部計装**
No. 529 - 1	Pellet D	non	PF
" - 2	" E	"	"
" - 3	" F	"	"
" - 4	" A	"	"
" - 5	" B	"	"
" - 6	" C	"	"
" - 7	" A	EF	EC
" - 8	" A G	PF	TF
" - 9	" B	EF	EC
" - 10	" B	PF	"
" - 11	" C	EF	"
" - 12	" C H	PF	TF

* Pellet A~Hの内容については, Table 2.1 参照

** PF; FPガス圧測定用

EF; 燃料スタック伸び測定用

EC; 被覆管伸び測定用

TF; 燃料中心温度測定用

中性子検出器の取付配置を Fig. 2.6 に示す。図中の寸法は IFA-529 燃料棒の燃料ペレット下端からの距離である。ND 3~ND 5 が半径方向, ND 1~ND 3 と ND 6 が軸方向分布測定用である。

Table 2.1 計装付燃料棒と部材の組合せ

Rod No.		Lower cluster rods						Upper cluster rods						Total	Remarks	
		529-1	- 2	- 3	- 4	- 5	- 6	- 7	- 8	- 9	-10	-11	-12			
Rod Parts																
Pellet	Fuel stack	C.P. pellet (φ 10.66) D	○55													
		" (φ 10.56) E		○55												
		" (φ 10.46) F			○55											
		MB pellet (φ 10.66) A				○55			○55	○40						
		" (φ 10.56) B					○55				○55	○55				
		" (φ 10.46) C						○55					○55	○40		
		MB hollow (φ 10.66) G								○15					○40	
		" (φ 10.46) H													○15	
Insulator	Solid (UO ₂)	○ 2	○ 2	○ 2	○ 2	○ 2	○ 2	○ 2	○ 1	○ 2	○ 2	○ 2	○ 1			
	Hollow (UO ₂)								○ 1				○ 1			
Insulator	Disc Zry-2	○	○	○	○	○	○									
	Disc (hollow) "								○				○			
Plenum spring	Spring with plate Spring	○	○	○	○	○	○	○	○	○	○	○	○			
Top end plug	Normal end plug	○	○	○	○	○	○									
	PF								○				○			
	EC															
	EF TE							○		○		○				
Bottom end plug	Normal end plug	○	○	○	○	○	○									
	PF															
	EC							○		○		○				
	EF TE								○				○			

2.4 炉出力履歴

HBWRは昭和55年6月30日にReactor Heatingが開始され、7月3日から出力上昇が開始された。しかし全出力で約4日間運転されただけで、7月14日に第3循環系内のバルブの修理のため炉停止された。運転再開は7月15日から行われ、その後、長短の炉停止を含め約150回の運転サイクルが行われた。その中の代表的な炉停止を以下に示す。

Table 2.1 HBWRのシャットダウン

炉 停 止 期 間	炉 停 止 原 因 (取 出 さ れ た IFA-No/装 荷 さ れ た IFA-No)
'80, 8 / 15 ~ 9 / 8 10 / 3 ~ 12 / 12	
'81, 1 / 17 ~ 1 / 29 2 / 8 ~ 4 / 1 4 / 8 ~ 4 / 11 6 / 7 ~ 6 / 20 8 / 25 ~ 9 / 2 10 / 3 ~ 12 / 20	Shut-down for PC1 Repair PA3 Repair Shut-down Na Steam delivery to SF Shut-down Period (161, 205, 413.3, 437.4, 517.6/413.4, 432.3, 512.5, 517.7)
'82, 2 / 3 ~ 2 / 25 3 / 17 ~ 3 / 20 4 / 7 ~ 4 / 8 4 / 12 ~ 5 / 19 5 / 30 ~ 6 / 14 6 / 27 ~ 6 / 30 7 / 5 ~ 7 / 7 7 / 11 ~ 7 / 13 7 / 31 ~ 8 / 13 8 / 18 ~ 8 / 19 8 / 24 ~ 9 / 20 10 / 13 ~ 10 / 17 10 / 25 ~ 11 / 8 11 / 20 ~ 11 / 24 12 / 8 ~ 12 / 17	Shut-down Period (412.6, 501.4, 517.7, 519.4/412.7, 501.5, 519.5) Shut-down Period (512.5, 516.1, 519.5, 522.1/511.4, 525.1) Shut-down Period (511.4, 524.4/524.3) Shut-down Period (525.1, 524.3/525.2) Shut-down Period (525.2/525.3) Shut-down Period (525.3/520.2) Shut-down Period (435.2, 525.4/420.5, 512.6, 519.6, 524.4) Shut-down Period (519.6, 524.4/) Shut-down Period (402.3, 420.5, 507.6, 519.6/402.4, 420.6, 512.7, 519.7, 524.4) Shut-down Period for Reactor Leakage Search Shut-down Period (512.7, 519.7/517.8, 541)

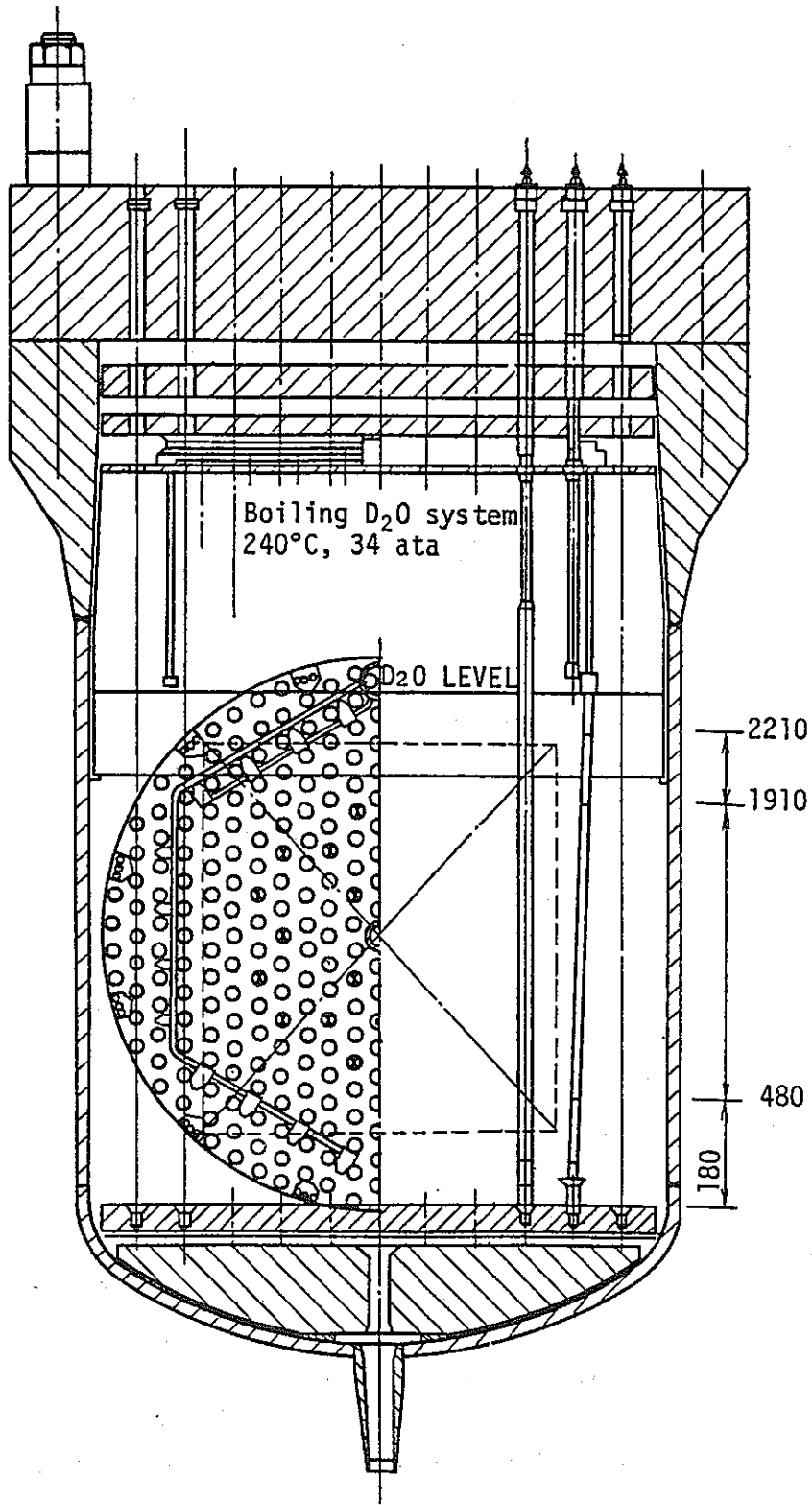
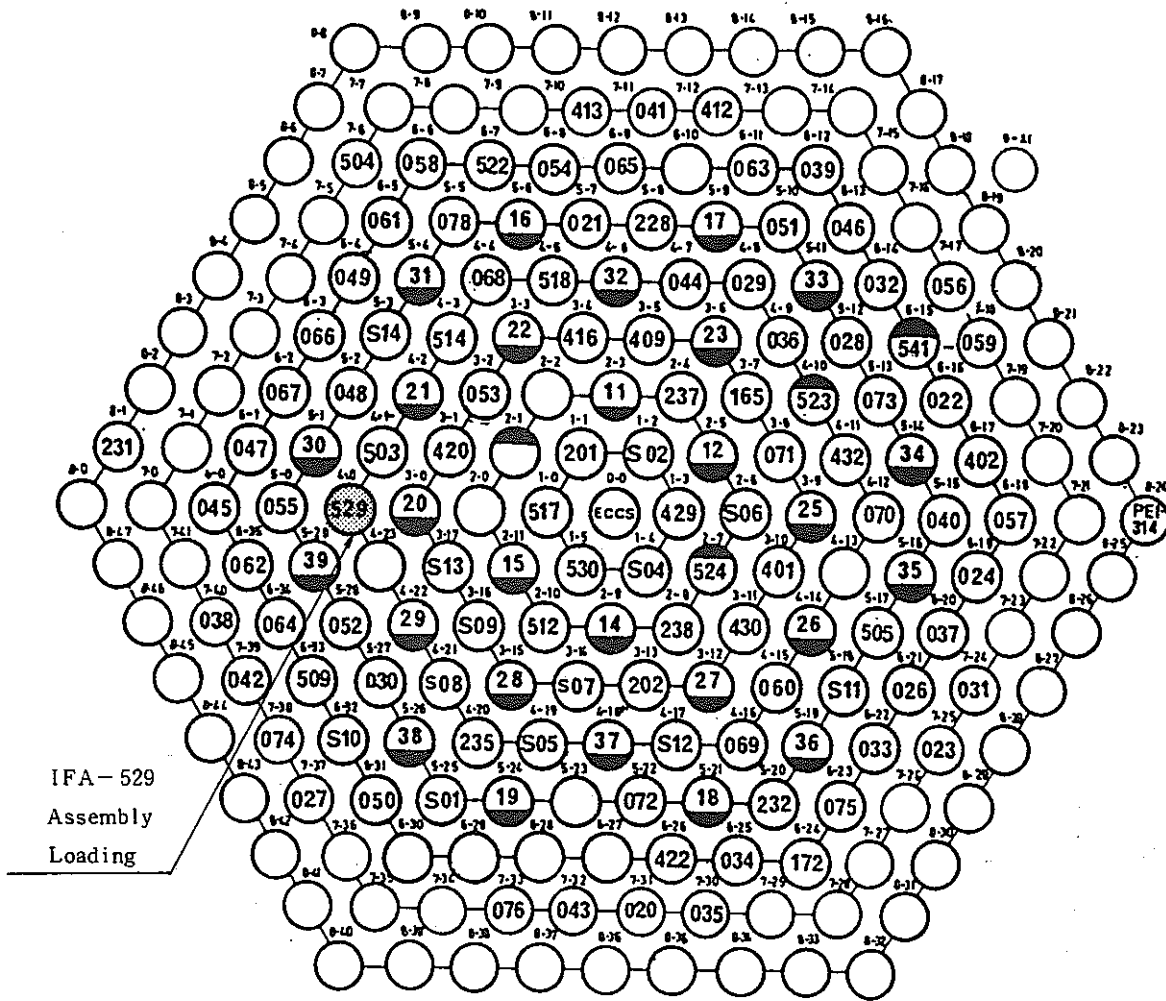
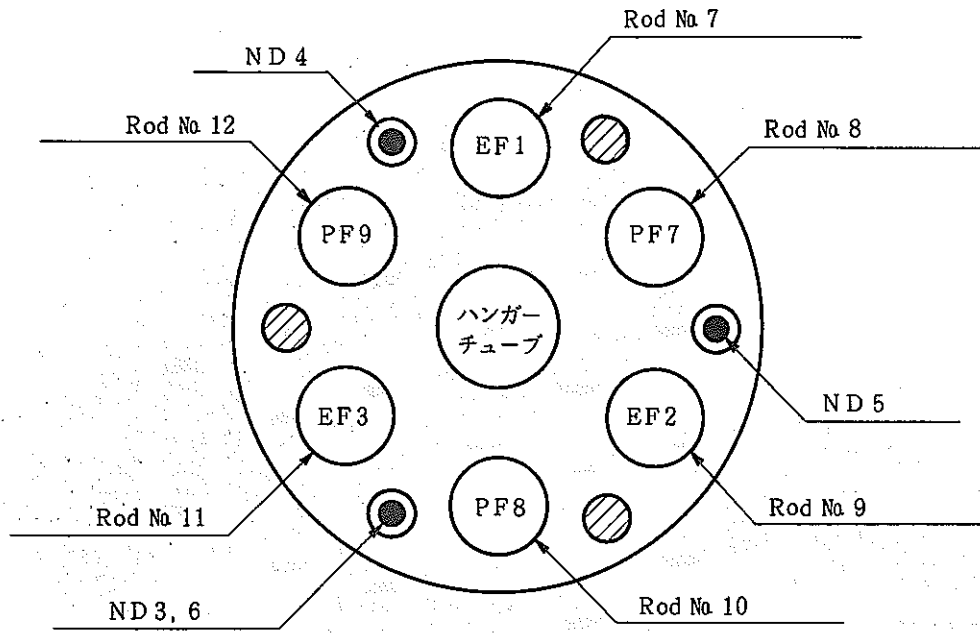

Fig. 2.1 HBWR 炉心概略图



HBWR IV CORE LOADING No.67		Dec. -82
19	Control rod (CS 19)	total : 27
202	Instrumented fuel assembly (IFA-202)	" : 34
021	Standard third charge assembly	" : 57
S01	Third charge spike assembly	" : 14
523	Pressure flask	" : 4

Fig. 2.2 1983年1月までの IFA-529 の照射位置



上部計装

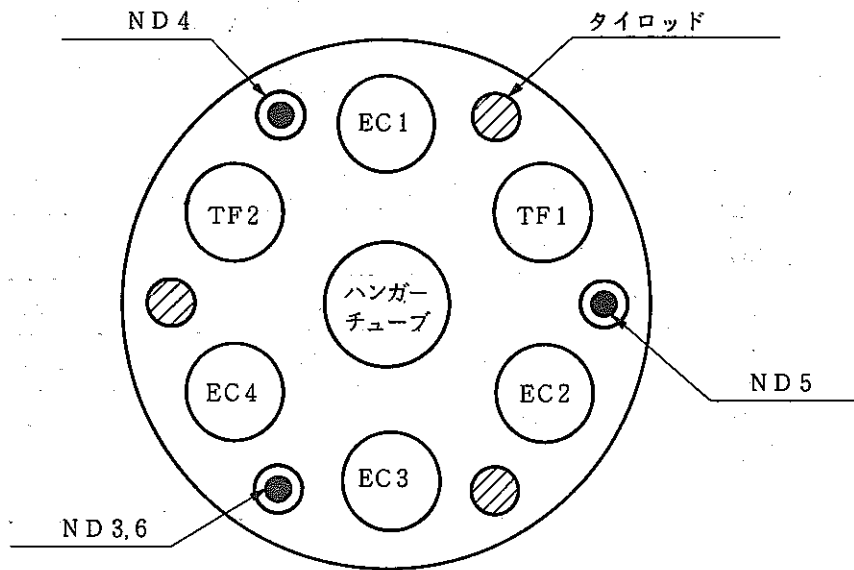

下部計装

Fig. 2.3 IFA-529 燃料棒配置 (上部クラスター)

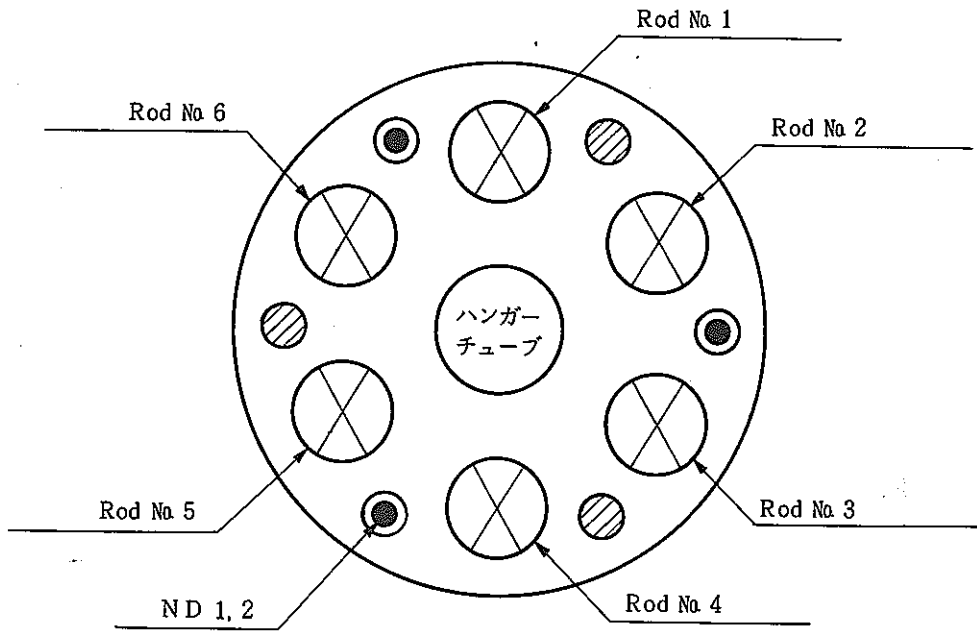

上 部 計 装

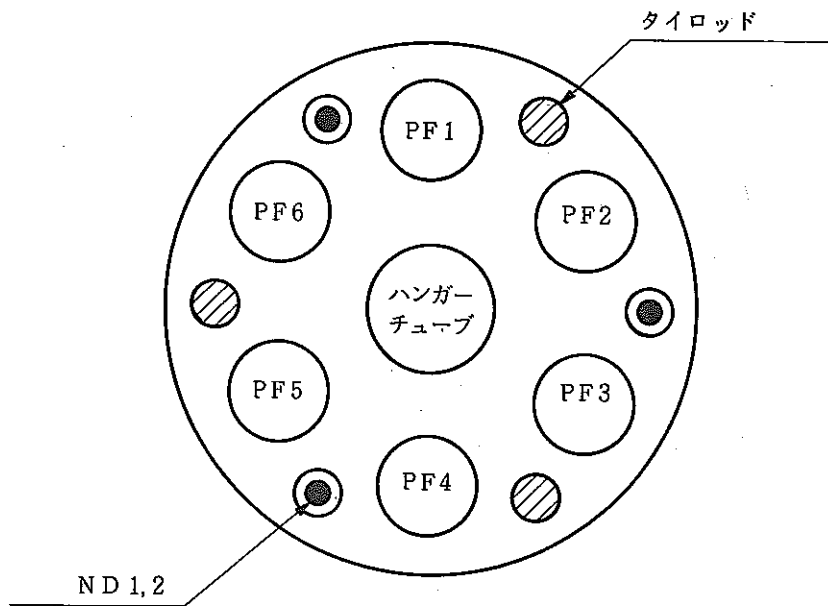

下 部 計 装

Fig. 2.4 IFA-529 燃料棒配置 (下部クラスター)

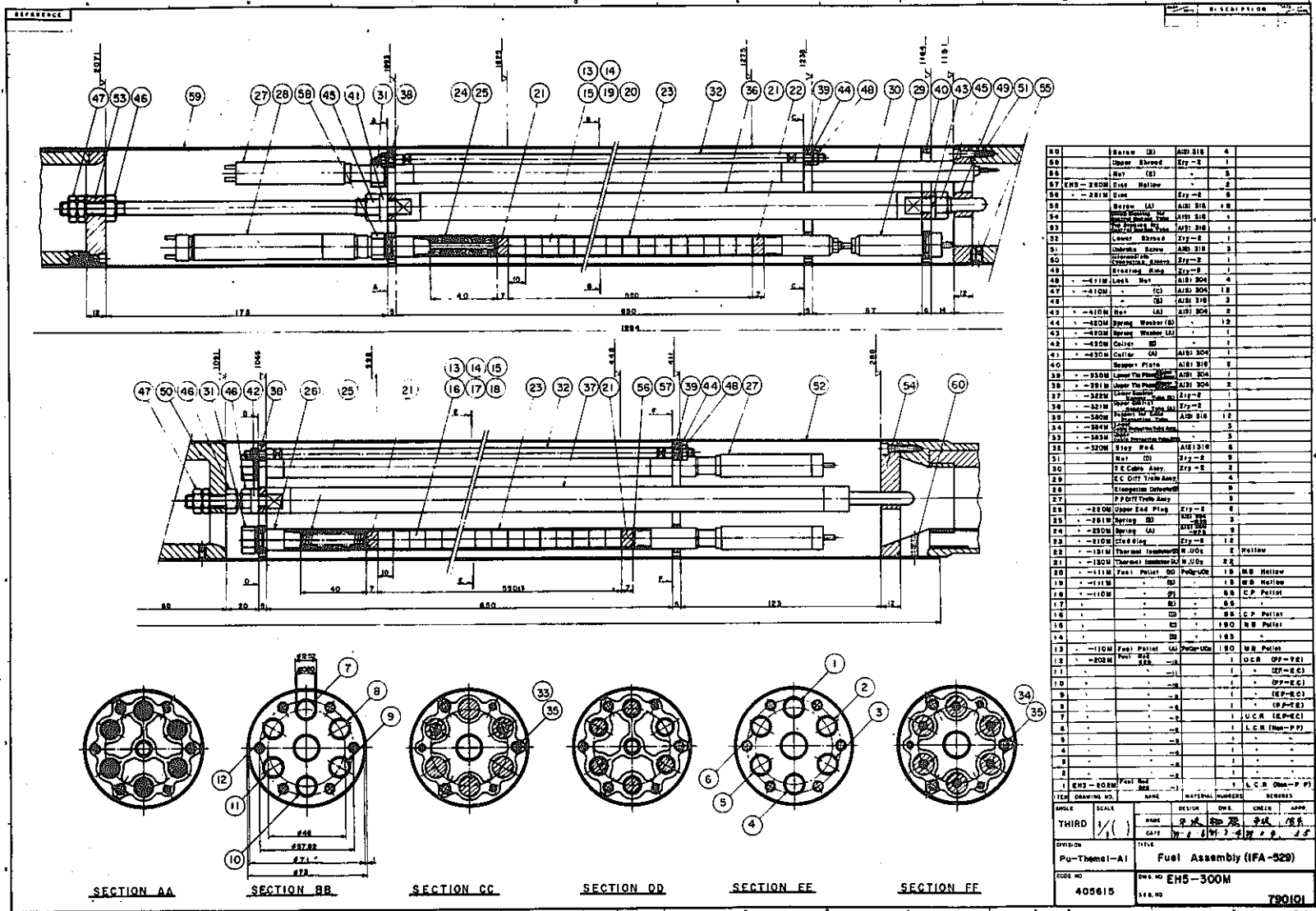

Fig. 2.5 IFA-529 燃料集合体図面

POWER REACTOR AND NUCLEAR FUEL DEVELOPMENT CORPORATION, TOKAI

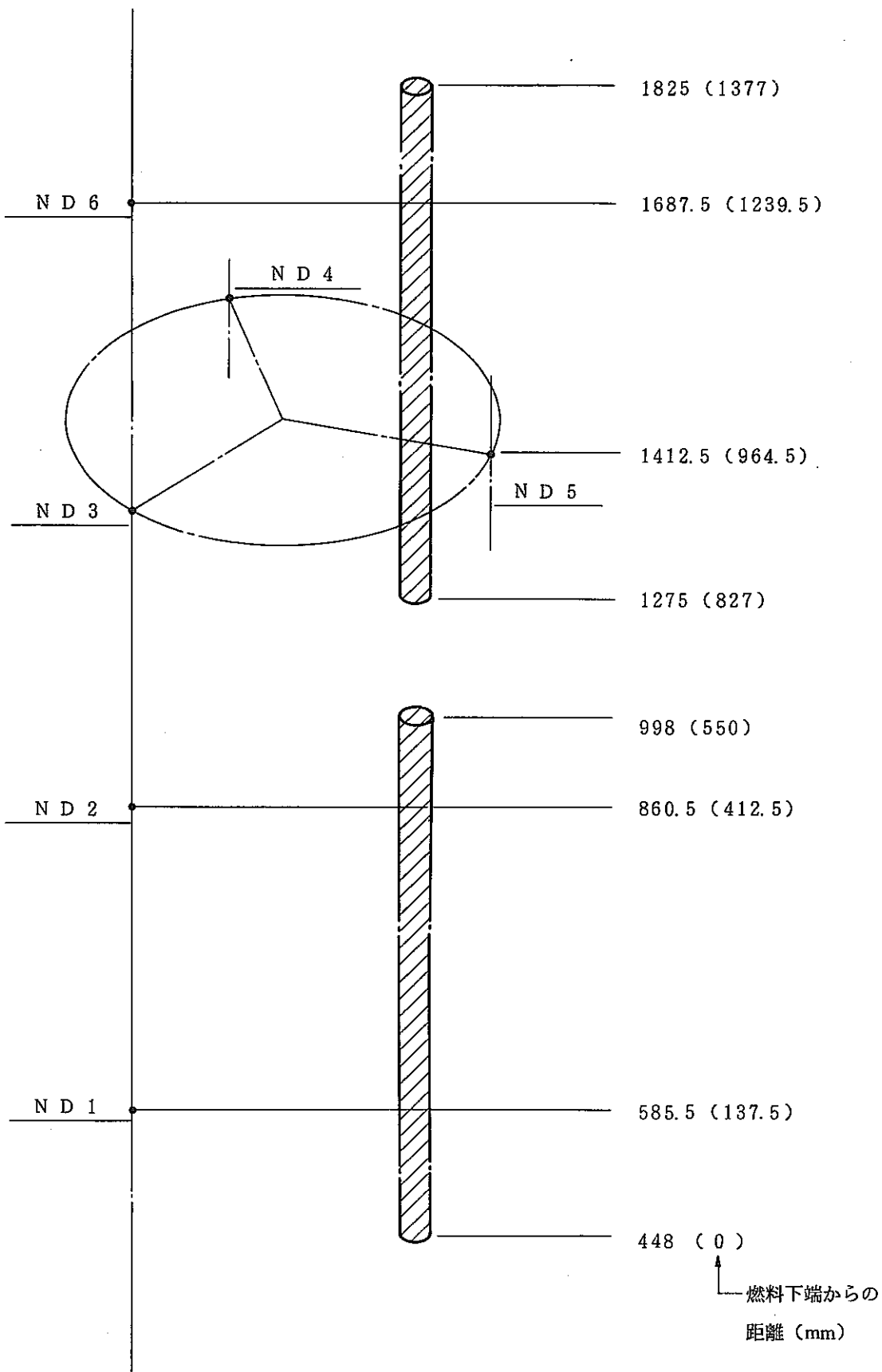

Fig. 2.6 IFA-529 中性子検出器の取付位置

3. IFA-529 燃料集合体の設計概要

IFA-529 燃料集合体は次のような目的を達成するために設計された。

- (1) 燃料ペレットと被覆管とのギャップをパラメータとした場合の機械的相互作用(PCMI)の研究
- (2) 混合転換燃料の確性試験
- (3) 単体分離法による燃料と混合転換燃料との照射挙動の比較研究
- (4) これらの燃料に計装(燃料棒計装)を取り付けて、次の照射中の挙動特性を調べる。
 - (イ) 燃料棒全長の伸び
 - (ロ) ペレットスタック長の伸び量および焼きしまり量
 - (ハ) ペレット中心温度
 - (ニ) FPガスの圧力およびFPガス放出率

以上の目的に添って設計された燃料集合体の設計概要を以下に示す。

(1) 集合体

- | | |
|---|------------|
| a. 集合体当りの燃料クラスタ数 | 2 (上部, 下部) |
| b. " PuO ₂ ・UO ₂ 重量 | 約 6.2 kg |
| c. " PuO ₂ 重量 | 約 515 g |

(2) クラスタ

- | | |
|---------------------------|------------|
| a. クラスタ当りの燃料棒本数 | 6本 |
| b. " タイロッド数 | 3本 |
| c. " センターハンガチューブ | 1本 |
| d. " 中性子検出器用保護管(ケーブルチューブ) | 3本 |
| e. " タイプレート数 | 2個(上部, 下部) |
| f. 燃料棒配置 | 3角格子 |
| g. 格子間隔 | 24 mm |

(3) 燃料棒

- | | |
|---------------|---------------|
| a. ペレットスタック長さ | 550 mm |
| b. プレナム長さ | 40 mm |
| c. 断熱ペレット | 天然ウラン(高さ7 mm) |
| d. 充填ガス | He 1気圧 |

(4) 燃料ペレット

- | | |
|--------------|--|
| a. 材質 | PuO ₂ ・UO ₂ 焼結ペレット |
| b. ウラン濃縮度 | 天然ウラン組成 |
| c. プルトニウム富化率 | ~6 w/o fiss. Pu |
| d. ペレット密度 | 94 % T.D. |

- e. ペレット直径 10.55 mm (公称径)
- f. ペレット形状 チャンファ付
- g. ペレット高さ 10 mm
- h. プルトニウム同位元素組成 (w/o)
 - Pu - 238 0.85
 - Pu - 239 66.6 $Pu^f = 73.9 \text{ w/o}$
 - Pu - 240 22.2
 - Pu - 241 7.3
 - Pu - 242 3.0
 - Am - 241 2.4

(5) 被覆管 (軽水炉 8×8タイプ使用)

- a. 材 質 ジルカロイ-2
- b. 外 径 12.52 mm
- c. 肉 厚 0.86 mm
- d. 内 径 10.80 mm

(6) シュラウド管

- a. 材 質 ジルカロイ-2
- b. 内 径 71 mm
- c. 長 さ 約 868 mm (下部), 1126 mm (上部)
- d. 肉 厚 1 mm

(7) 計装 (集合体当り)

- a. タービン型流量計 (チャンネル入口, 出口) 2 基
- b. 冷却材重水温度測定用熱電対 (チャンネル入口, 出口) 6 "
- c. 集合体出力測定用中性子検出器 6 "
- d. 燃料破損検出器 (蒸気サンプラー) 1 "
- e. 流量調整用バルブ 1 "

(8) 計装 (燃料棒)

- a. 被覆管伸び測定器 (EC) 4 基
- b. 燃料スタック伸び測定器 (EF) 3 "
- c. 燃料中心軸温度測定器 (TE) 2 "
- d. プレナム圧測定器 (PF) 9 "

燃料棒の図面を Fig. 3.1 に示す。

4. 燃料照射データ

4.1 計装データ処理

IFA-529 に取り付けられた計装より得られるデータ TFDR (Test Fuel Data Report) として数サイクル毎にハルデンプロジェクトより入手した。

磁気テープに記録された TFDR は、HBWR 照射試験データ整理コード「HALFMOON」を用いて編集を行った。

なお、「HALFMOON」コードの概要は IFA-514 燃料集合体の照射データ中間報告書⁴⁾にて報告済みである。

4.2 計装の状況

計装は概ね順調に作動している。以下に各計装の状況をまとめる。

(1) 被覆管伸び測定器 (EC)

EC1 (Rod-7), EC2 (Rod-9), EC3 (Rod-11) は順調に作動している。

(2) 燃料スタック伸び測定器 (EF)

EF1 (Rod-7), EF2 (Rod-9), EF3 (Rod-11) は順調に作動している。

(3) 燃料中心軸温度測定器 (TF)

TF1 (Rod-8), TF2 (Rod-12) 共に順調に作動している。

(4) プレナム圧測定器 (PF)

PF2 (Rod-2) が 1981 年 2 月に 2 次ケーブルの回路系ショートのため停止したが、1982 年 12 月 6 日より順調に作動している。PF1 (Rod-1), PF3 (Rod-3), PF4 (Rod-4), PF5 (Rod-5), PF6 (Rod-6) は順調に作動している。

(5) タービン型流量計 (FI, FO)

出口流量計 (FI) は 1981 年 6 月, 入口流量計 (FO) は 1982 年 7 月に停止した。

(6) 冷却材重水温度測定用熱電対

順調に作動している。

(7) 集合体出力測定用中性子検出器 (ND)

順調に作動している。

4.3 照射データ

「HALFMOON」から得られた各燃料棒の 1980 年度から 1983 年度までの年別の線出力履歴を付録 1 に、1980 年 7 月から 1983 年 1 月までの月別の線出力履歴を付録 2 に示す。また付録 3 には「HALFMOON」より得られた主要サイクルの軸方向出力分布を示す。

付録 4 には、ハルデンプロジェクトより送られてきた PF (燃料棒内圧) データを、付録 5 には

EC（被覆管伸び）データを、付録6には、EF（燃料スタック伸び）データを、付録7にはTF（燃料中心温度）データを示す。

またハルデンプロジェクトより送られてきた1980年6月から1983年1月までのハルデン炉の運転履歴は、IFA-514集合体の照射データ中間報告書に報告済である⁴⁾。

5. 今後の計画

5.1 照射計画

IFA-529は、1986年3月まで照射を継続する予定である。現在の所、計装は概ね順調に作動しており、今後の照射により、高燃焼度領域における照射データを得る。なお、HBWRは1983年1月から3月までの3ヶ月、高フラックス化の改良工事が行なわれ、軽水炉並の濃縮度の試験燃料を用いた照射試験が可能となった。この高フラックス化に伴い、IFA-529は炉心外側へ移され、Fig. 5.1に示す様に、8-22チャンネルに装荷された。

5.2 データの解析・評価

IFA-529から得られる計装データは、IFA-514から得られる計装データとともに、計装データ処理コード「HALFMOON」を用いて評価されており、今回得られたデータについての評価結果は、ハルデン拡大会議等にて発表した^{9)~8)}。また、本試験より得られる計装データは、ATR燃料設計コード「ATFUEL」の信頼性向上のための検証データとして用いており、今後得られるデータを用いて、高燃焼度領域の信頼性向上を図る予定である。

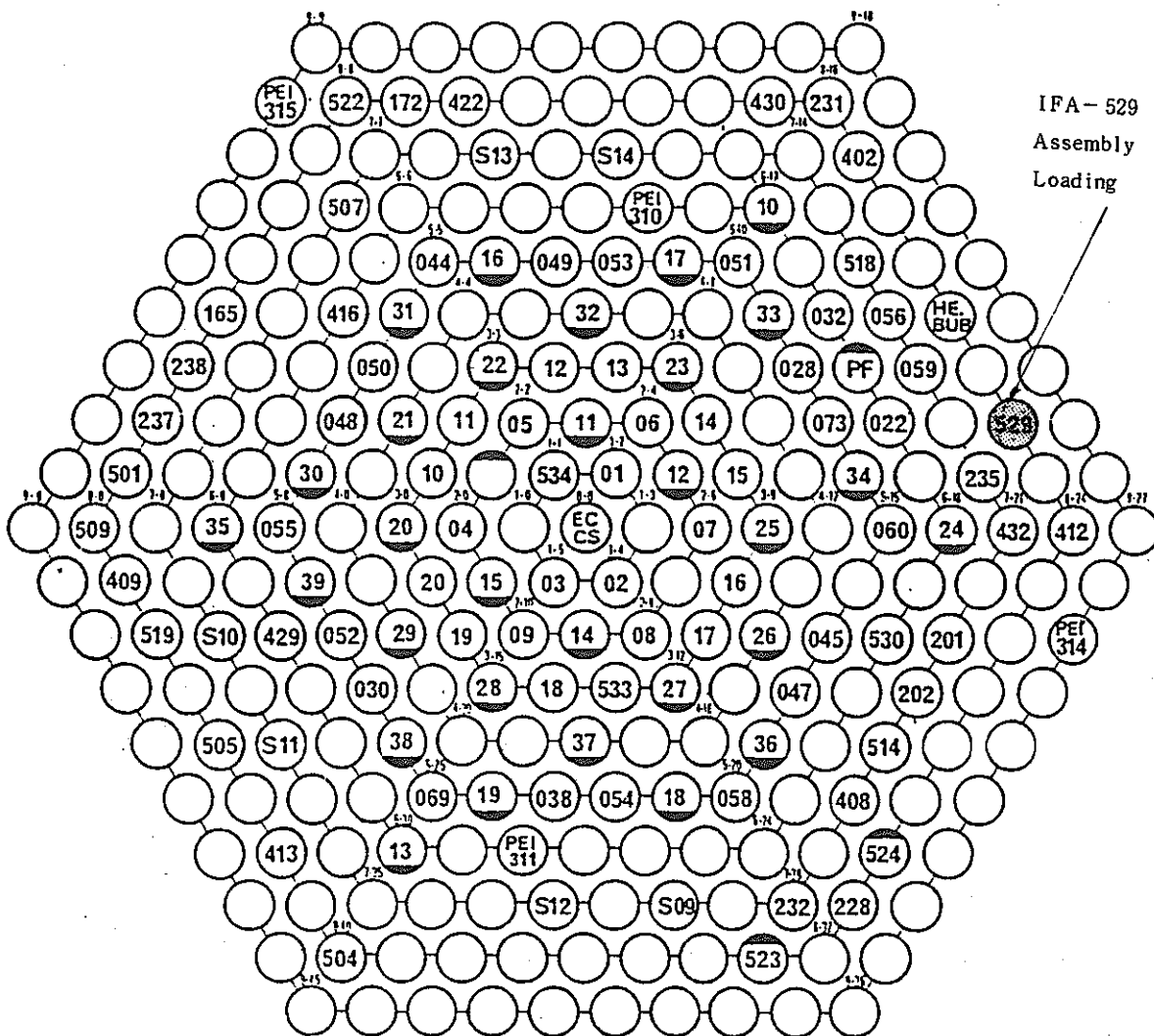

HBWR Y CORE LOADING No.1		February -83
19	Control rod (CS 19)	total: 30
202	Instrumented Fuel Assembly (IFA-202)	35
021	Standard third charge assembly	22
S01	Thlrd charge spike assembly	6
09	Standard fifth charge assembly	20
523	Pressure flask	4

Fig. 5.1 HBWR 炉心改良後の燃料棒配置

6. 参 考 文 献

- 1) 湯本, 平沢, 清永, 千崎, 板川, 鹿島, “「軽水炉用」プルトニウム富化燃料のHBWR (第二次) 照射試験(I) IFA-529 燃料集合体の設計”, SN841-79-53, 1979年10月
- 2) 本田, 横内, 衣笠, 堀井, 関, 豊島, 石川, 鹿島 “「軽水炉用」プルトニウム富化燃料のHBWR (第二次) 照射試験(II) IFA-529 燃料要素の製造”, PNC ZN843-83-01, 1983年4月
- 3) OECD ハルデンプロジェクト 25 周年記念パンフレット
- 4) 横内, 久保, 安部, 井坂, “「軽水炉用」プルトニウム富化燃料のHBWR 照射試験, (III) IFA-514 燃料集合体の照射データ中間報告”, PNC ZN841-83-69, 1983年9月
- 5) Y. Yokouchi, T. Kajiyama, R. Yumoto, “Thermal and Mechanical Behaviours of Plutonium-Uranium Mixed Oxide Fuel (IFA-514 and IFA-529)”, Enlarged HPG Meeting, Hango, Norway (1981)
- 6) M. Kubo, T. Abe, Y. Yokouchi, “Thermal and Mechanical Behaviours of Plutonium-Uranium Mixed Oxide Fuel (IFA-514 and IFA-529 Interim Report)”, Enlarged HPG Meeting, Loen, Norway (1983)
- 7) 安部, 久保, 横内, “PuO₂-UO₂ 燃料の炉内照射特性ハルデン炉における IFA-514, 529 燃料の照射特性”, 原子力学会「昭 58 分科会」G6
- 8) K. Domoto, Y. Yokouchi, Y. Mishima, “The Development of ATR MOX Fuels”, IAEA Specialists Meeting on Improved Utilization of Water Reactor Fuel with Special Emphasis on Extended Burnups and Plutonium Recycling, CEN/SCK Mol, Belgium (1984)

付 録 1

I F A - 529 各燃料棒の年別の線出力履歴

(1980年～1982年度)

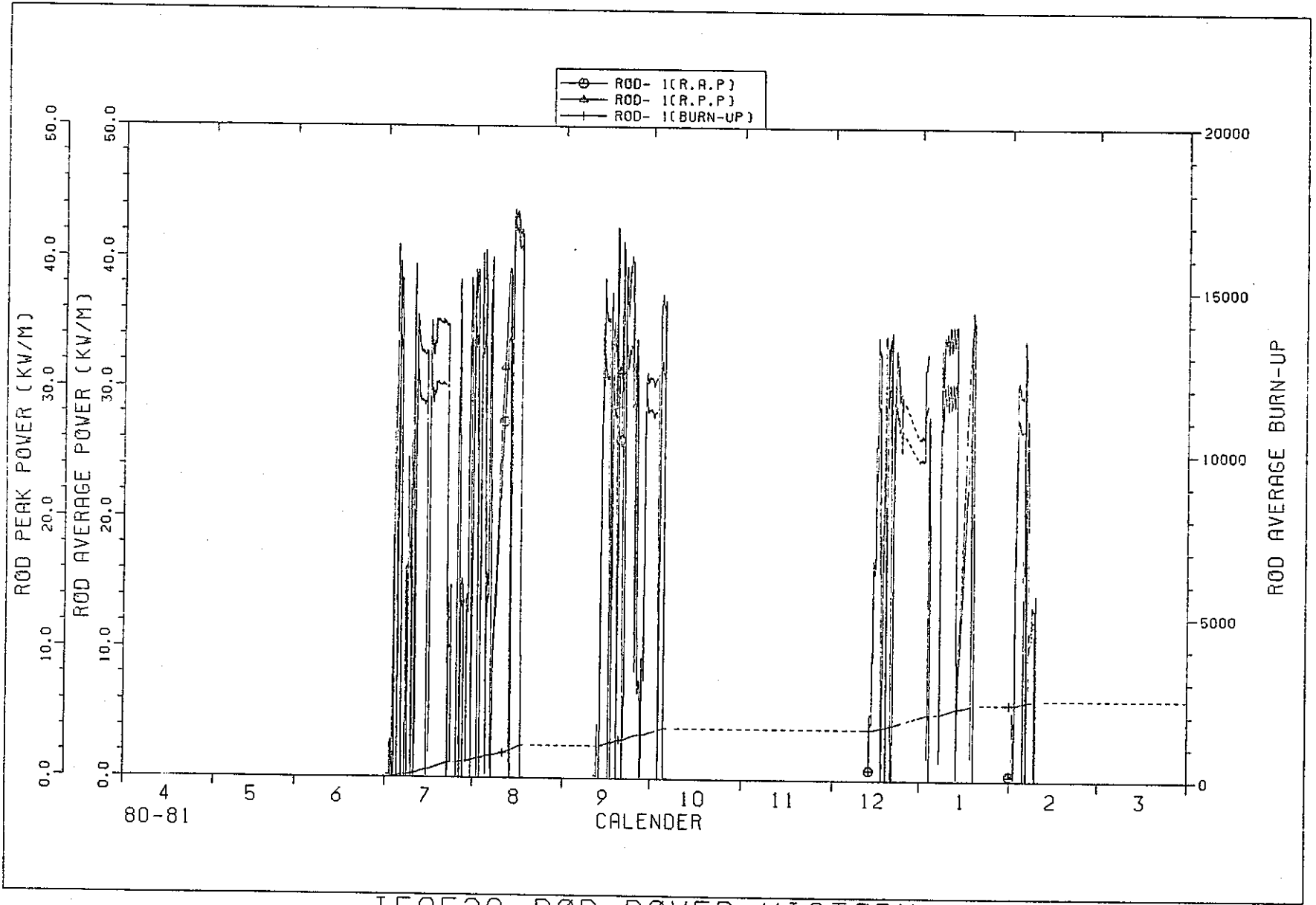

IFA529 ROD POWER HISTORY

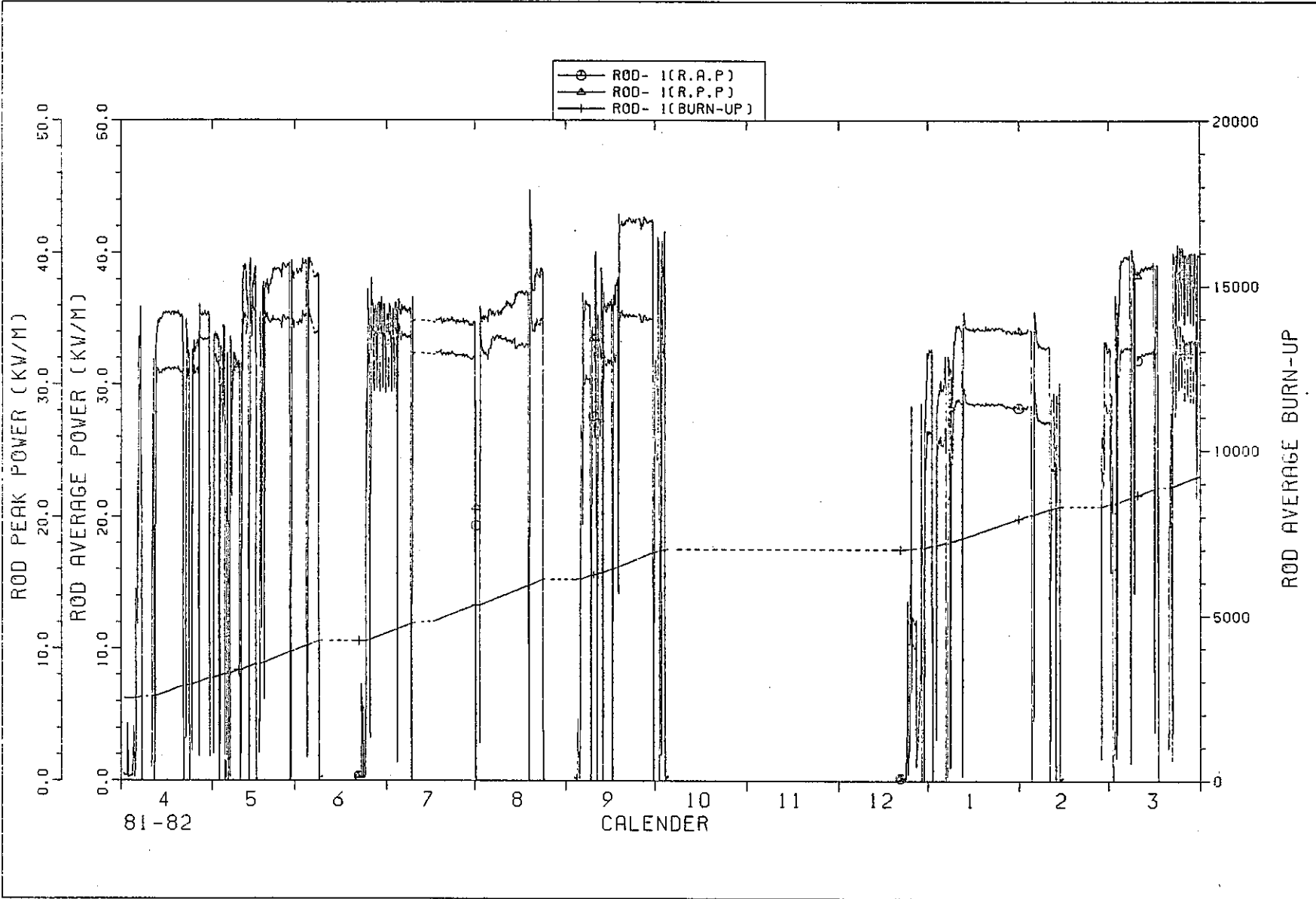

IFA529 ROD POWER HISTORY

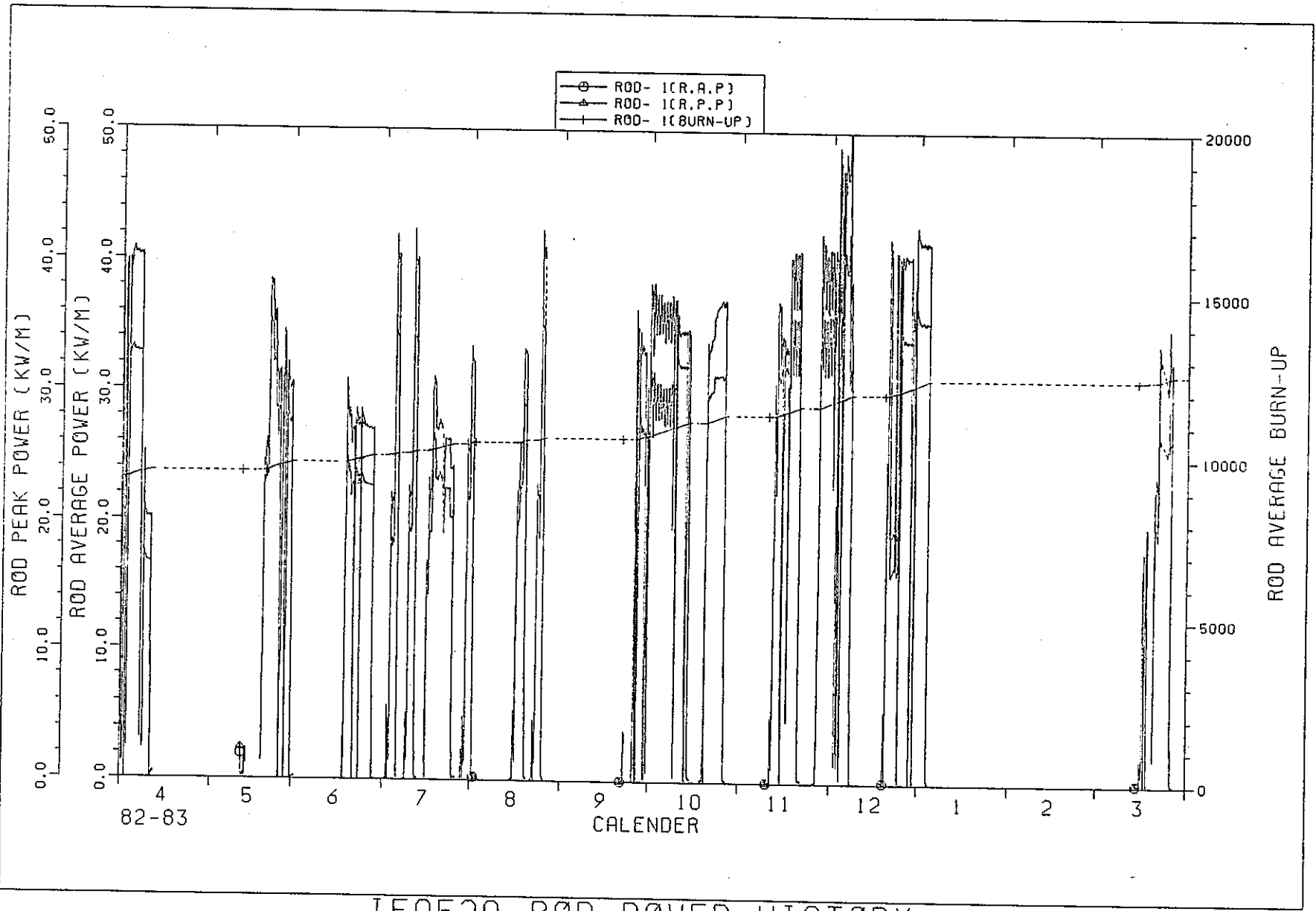

IFA529 ROD POWER HISTORY

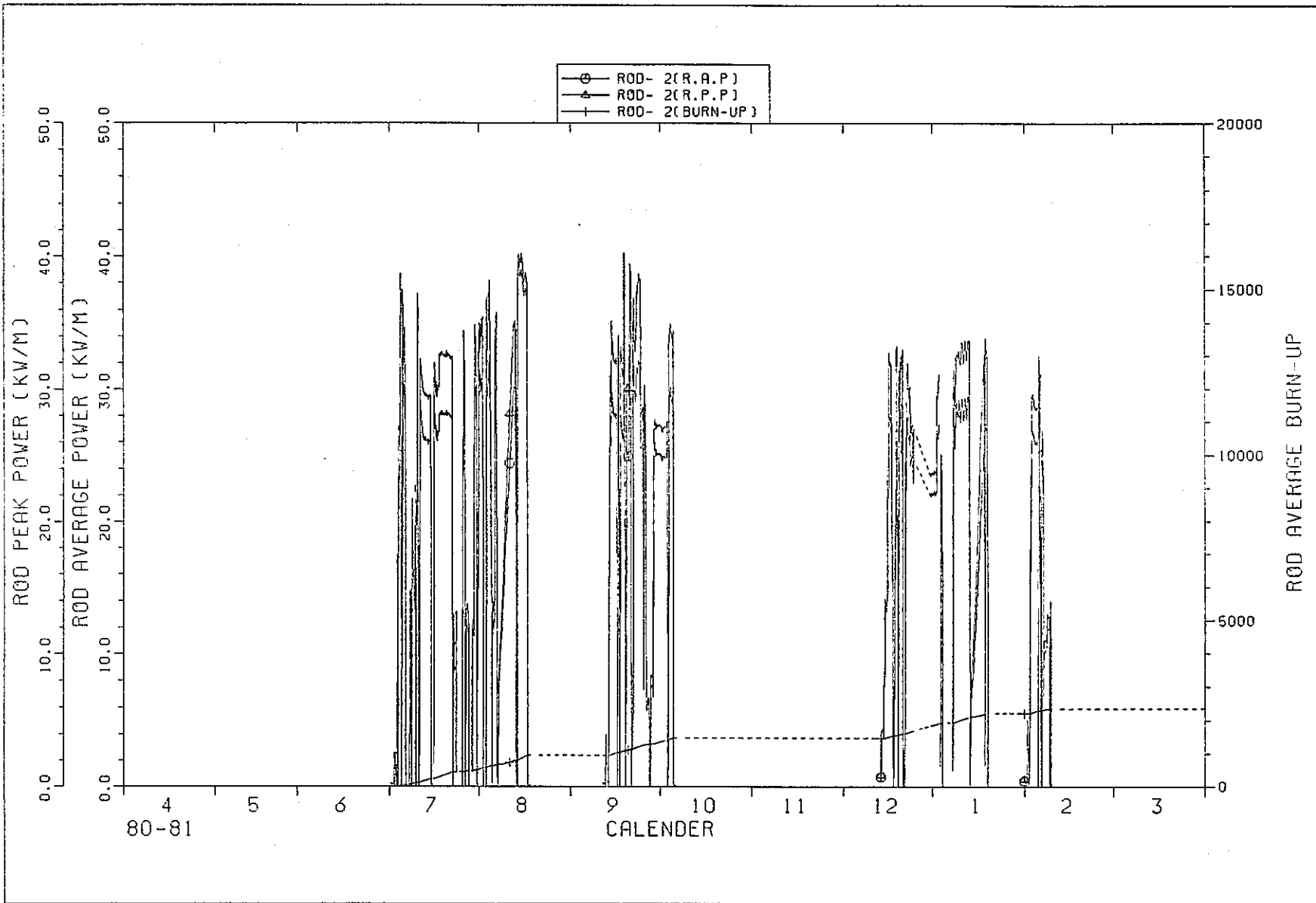

IFA529 ROD POWER HISTORY

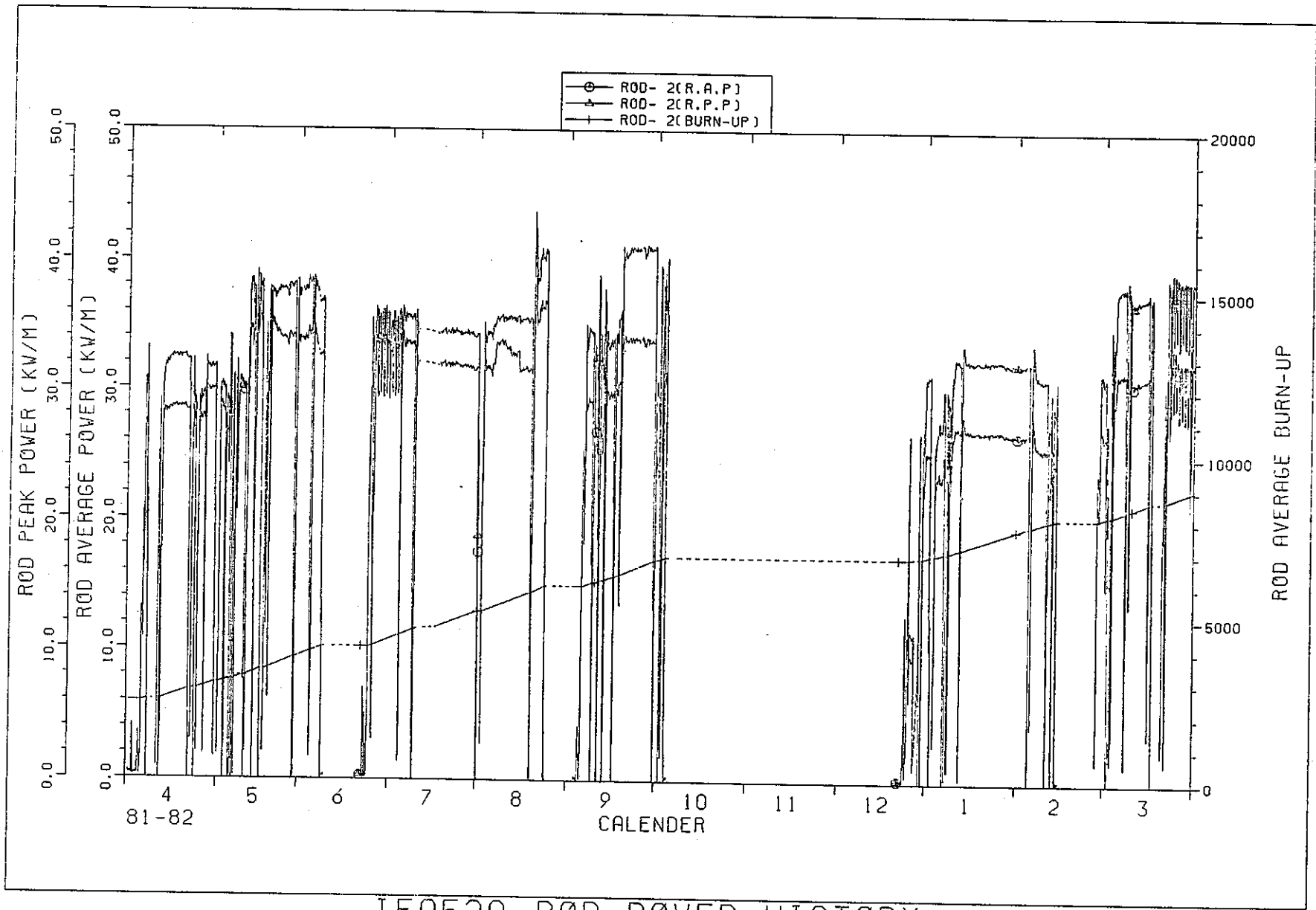

IFA529 ROD POWER HISTORY

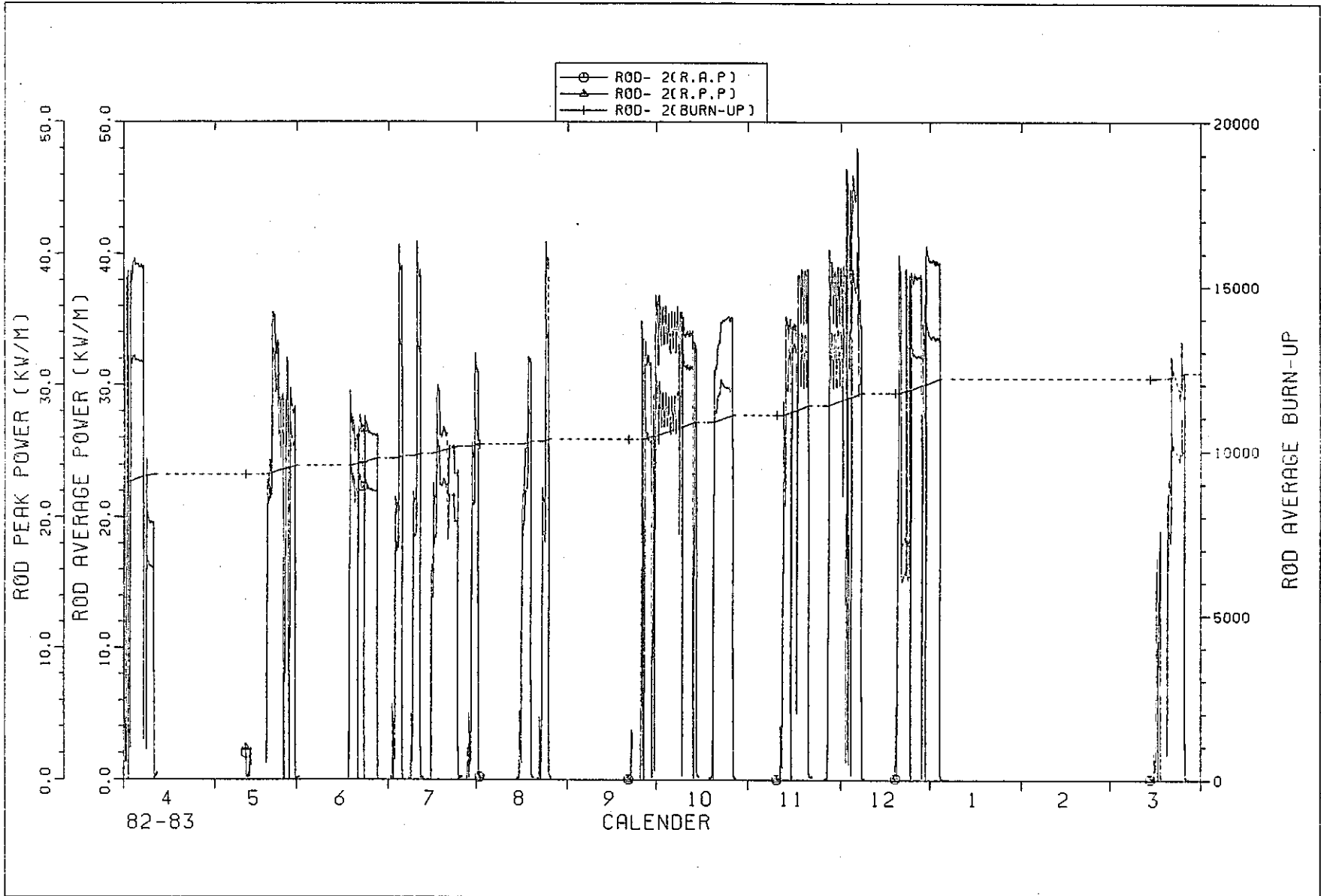

IFA529 ROD POWER HISTORY

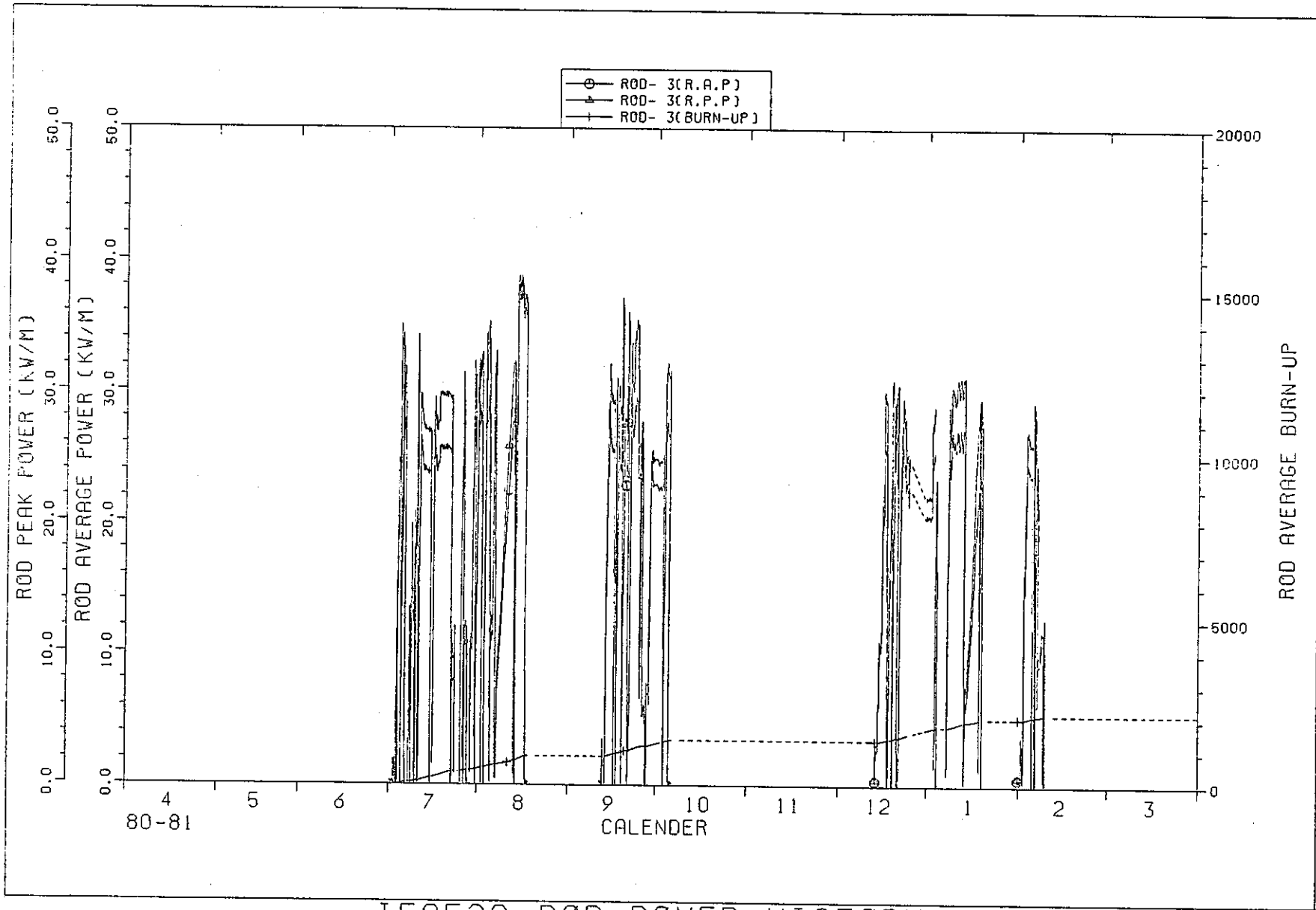

IFA529 ROD POWER HISTORY

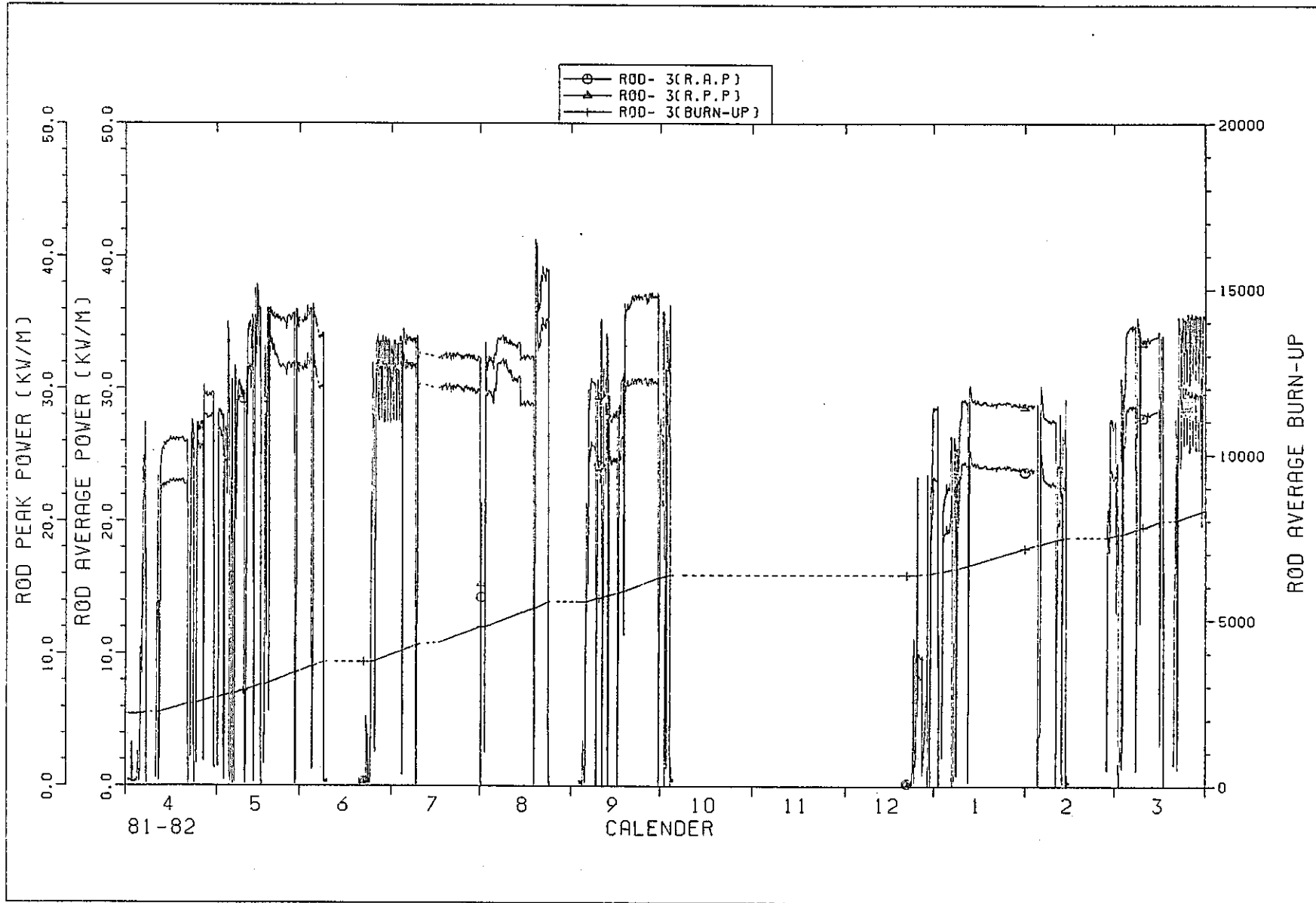

IFA529 ROD POWER HISTORY

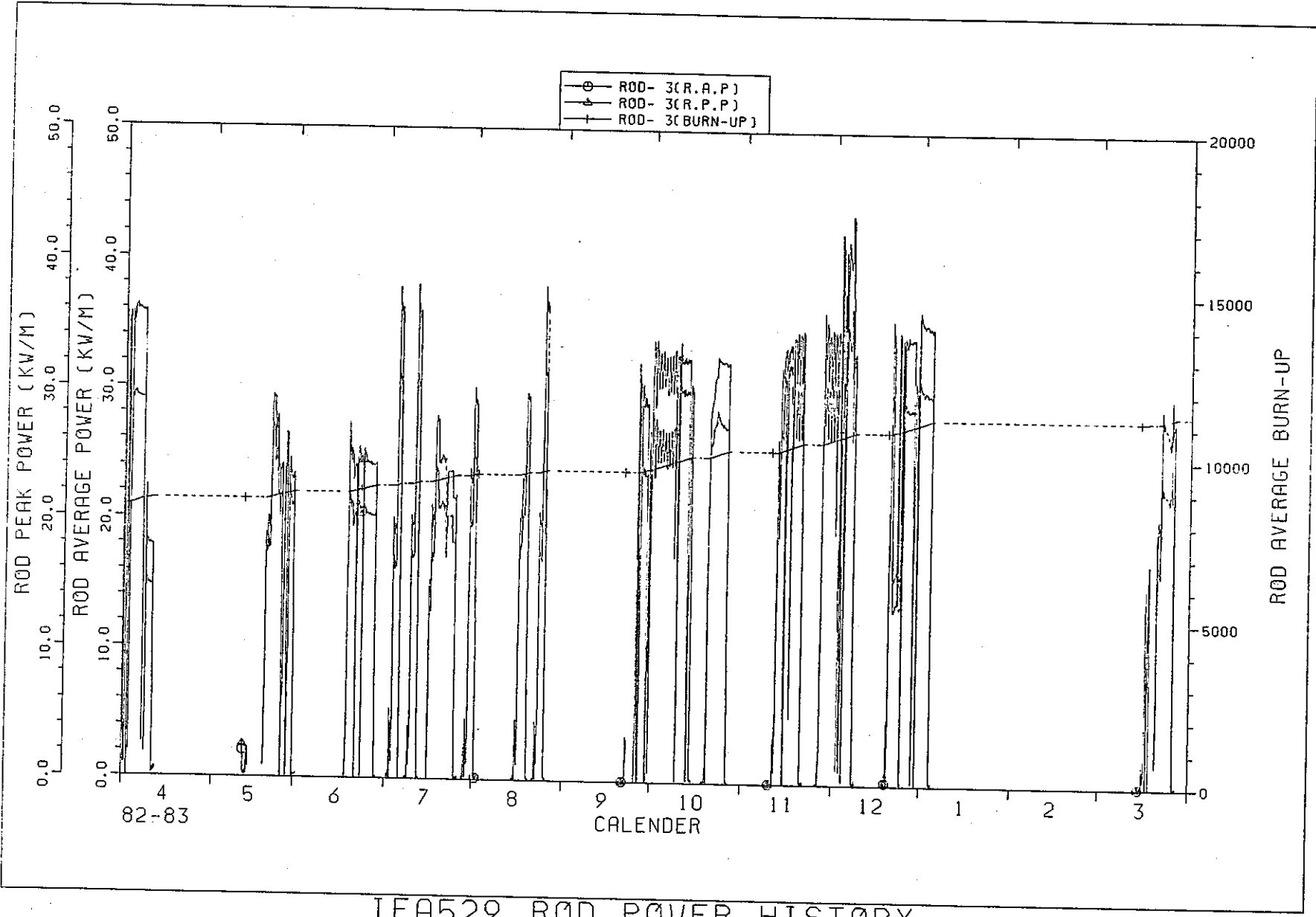

IFA529 ROD POWER HISTORY

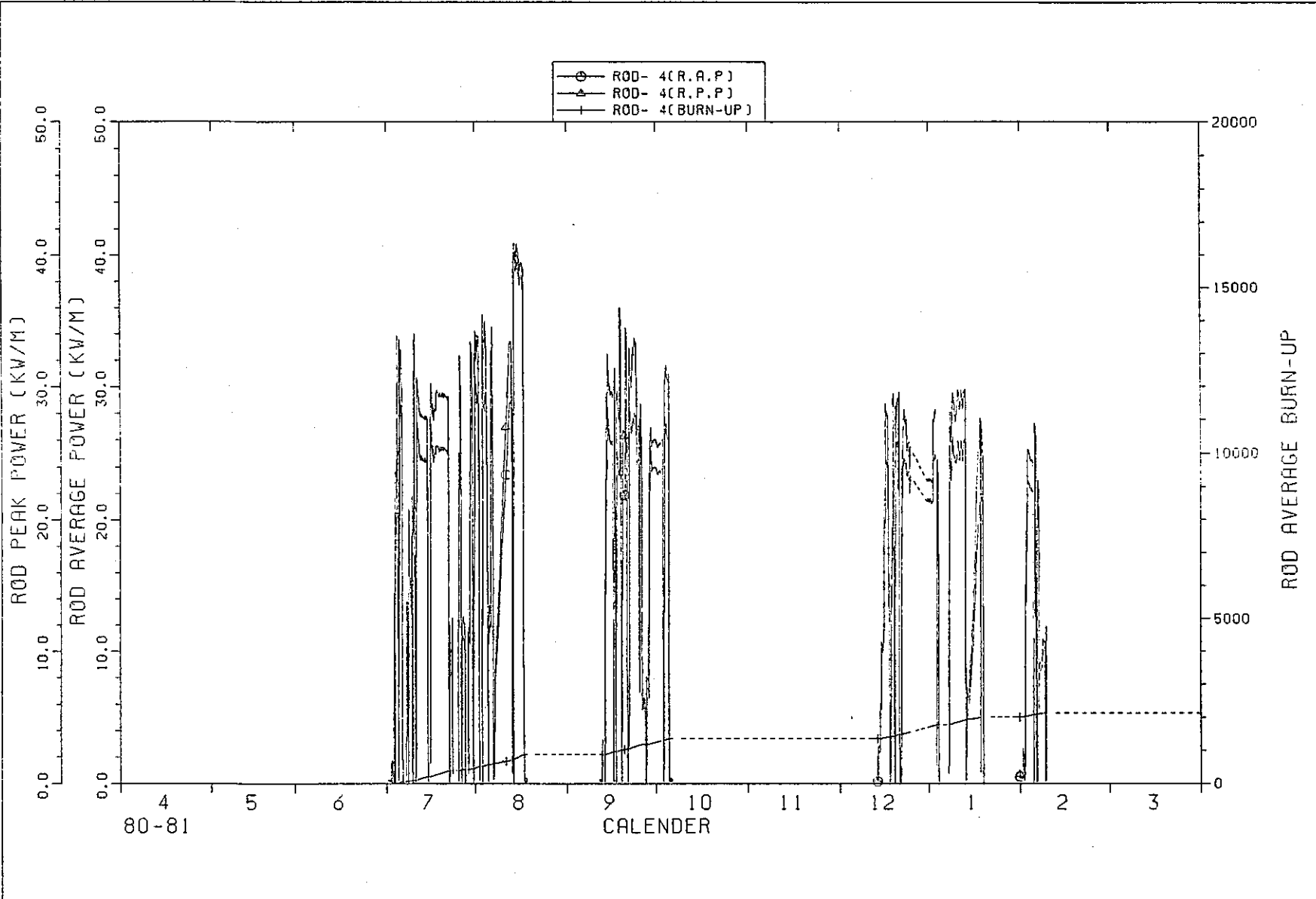

IFA529 ROD POWER HISTORY

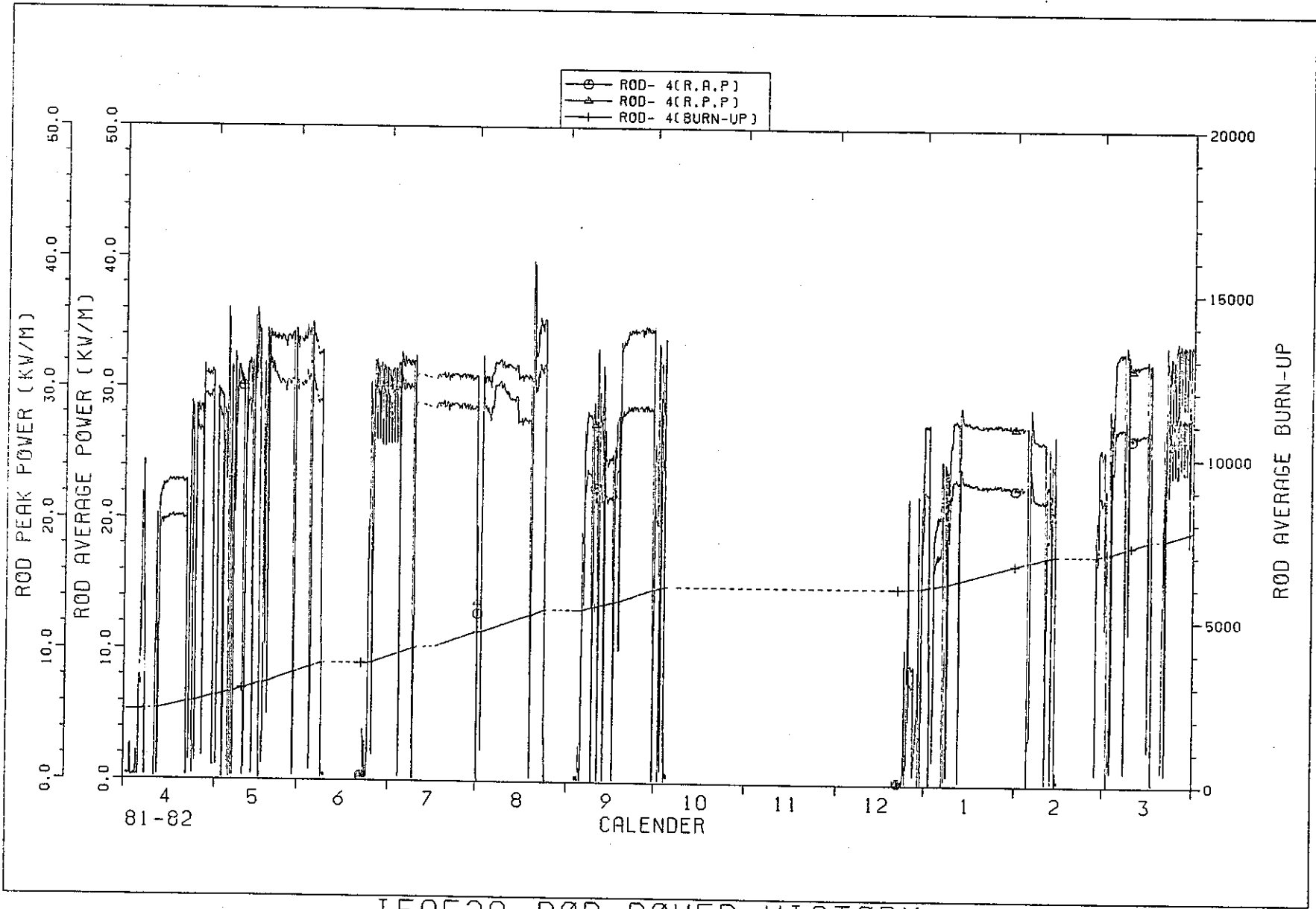

IFA529 ROD POWER HISTORY

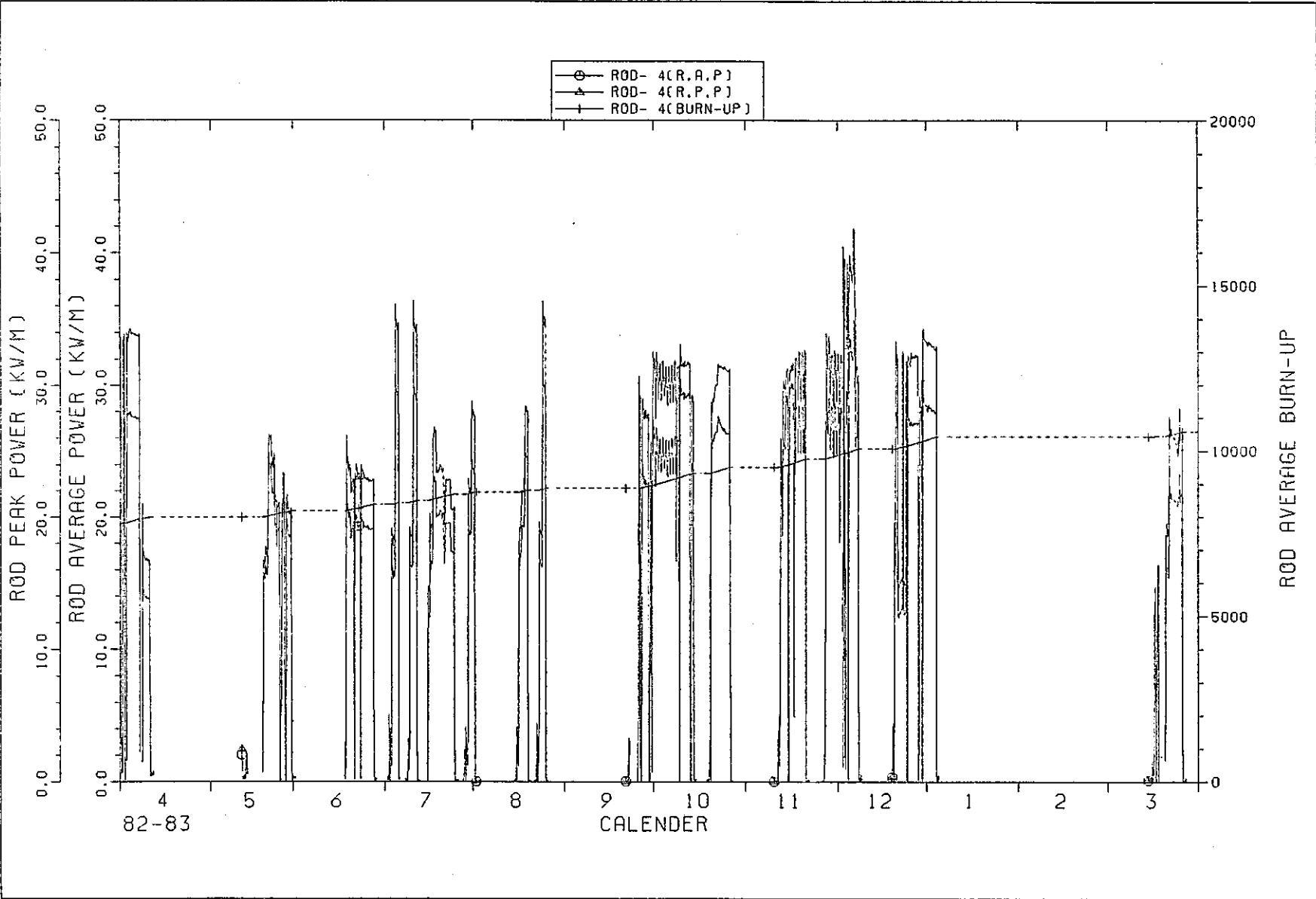

IFA529 ROD POWER HISTORY

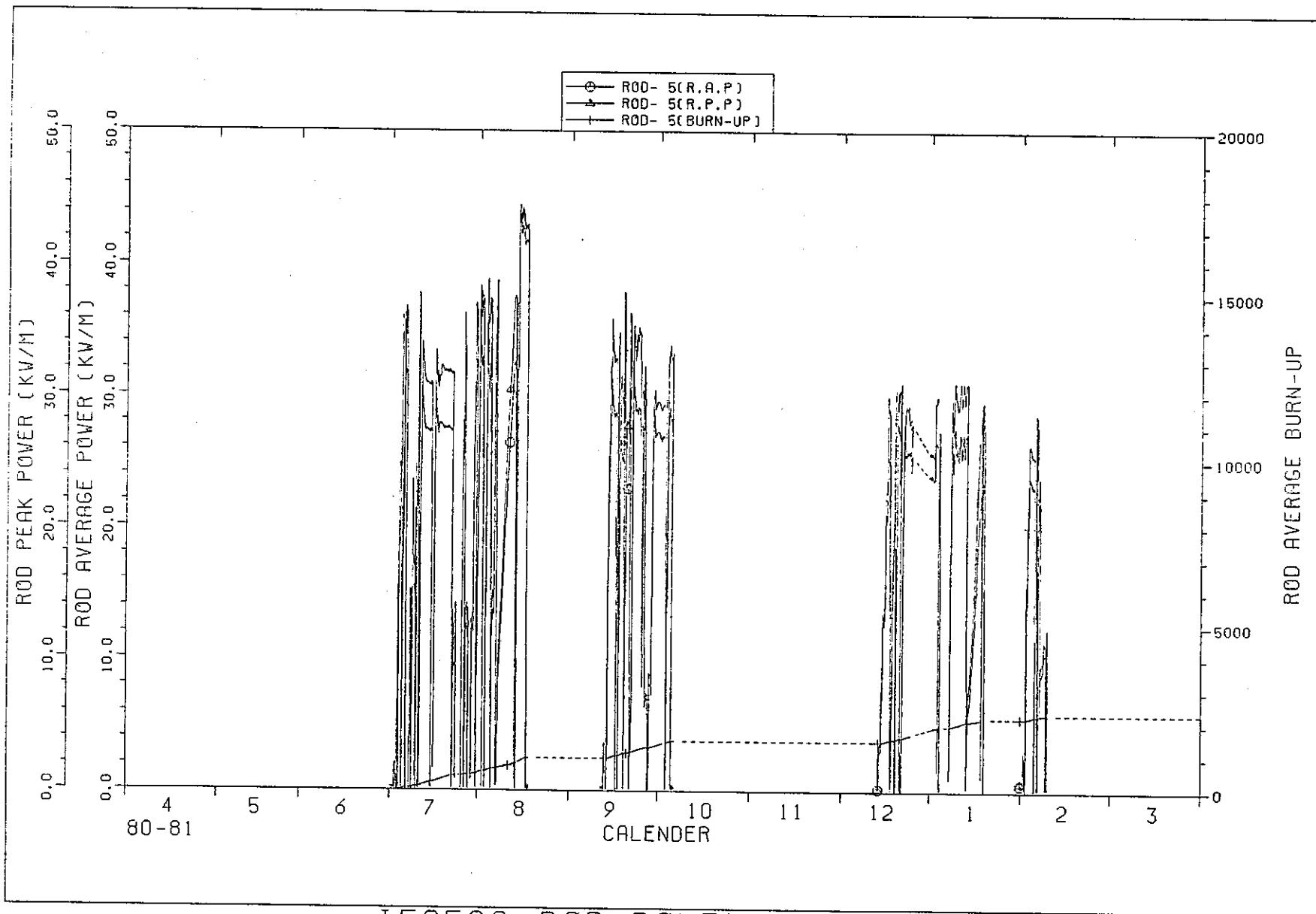

IFA529 ROD POWER HISTORY

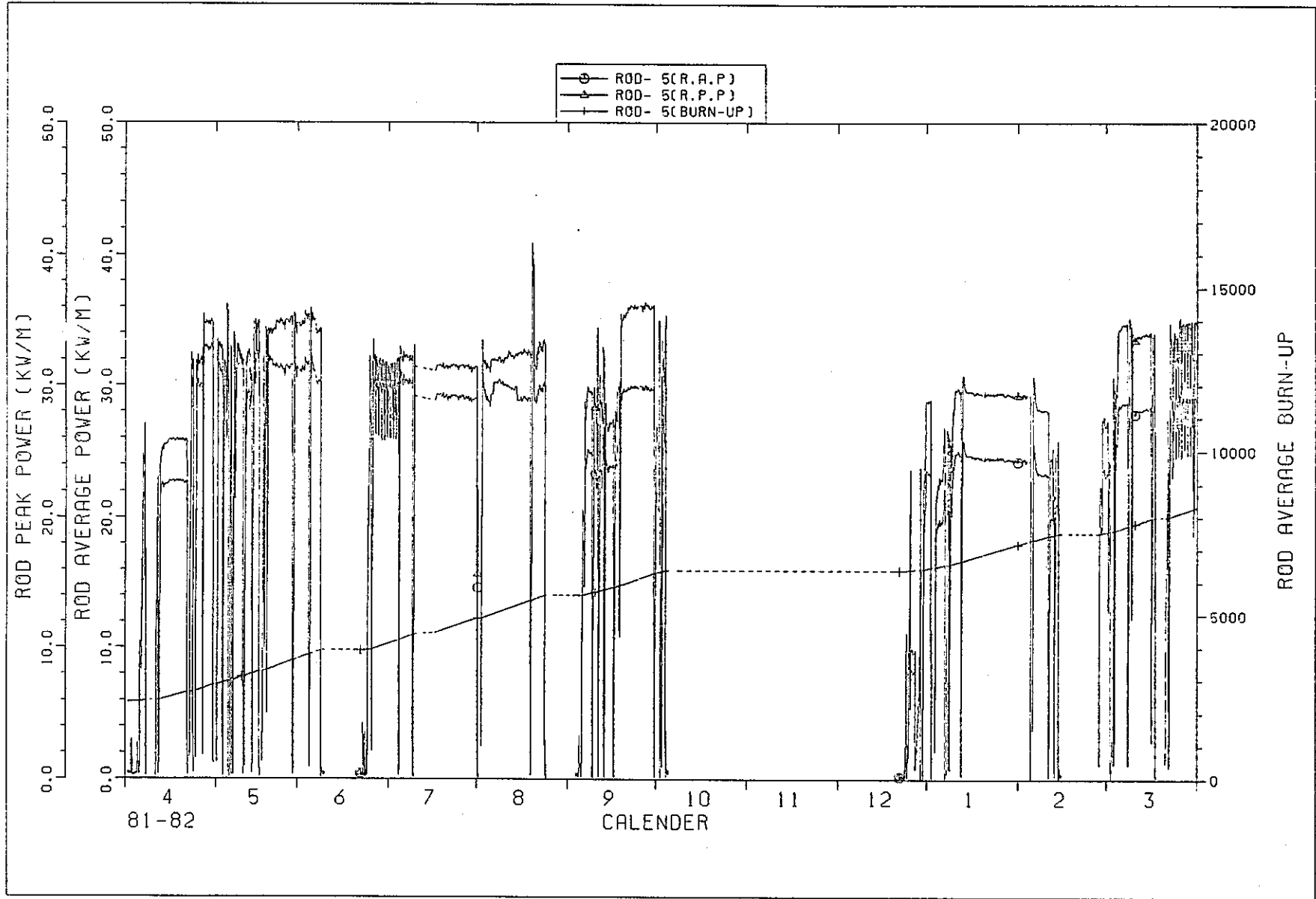

IFA529 ROD POWER HISTORY

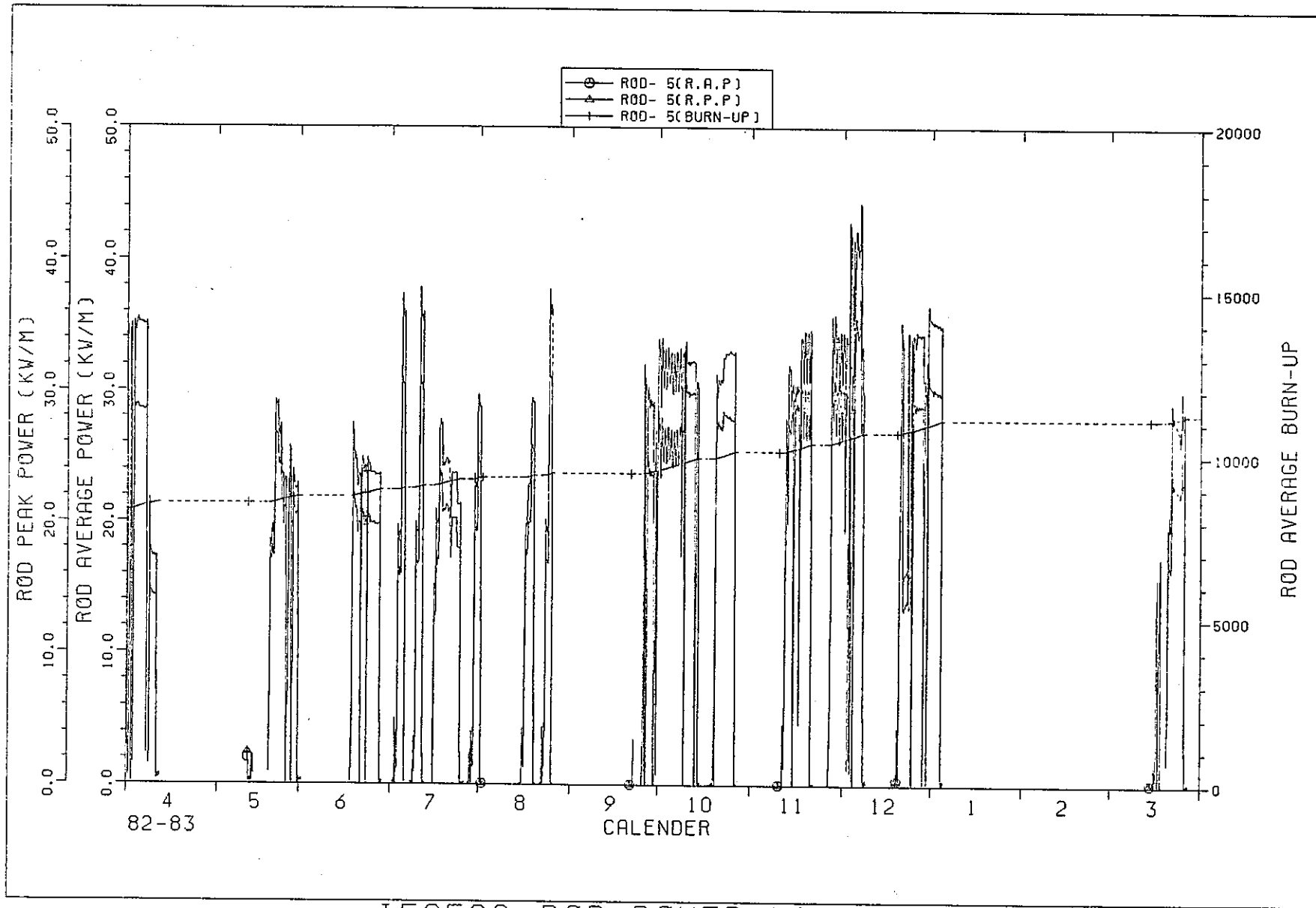

IFA529 ROD POWER HISTORY

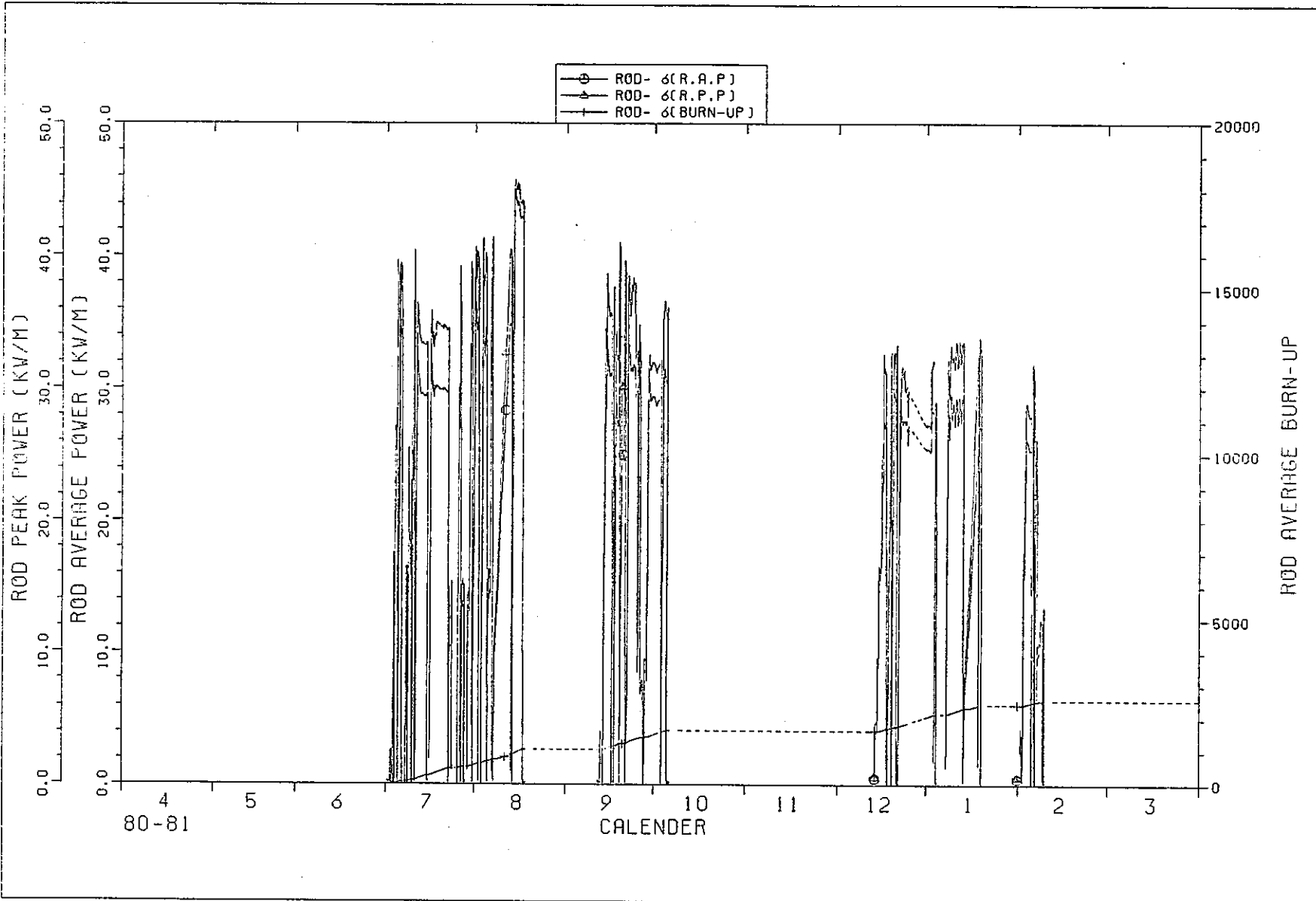

IFA529 ROD POWER HISTORY

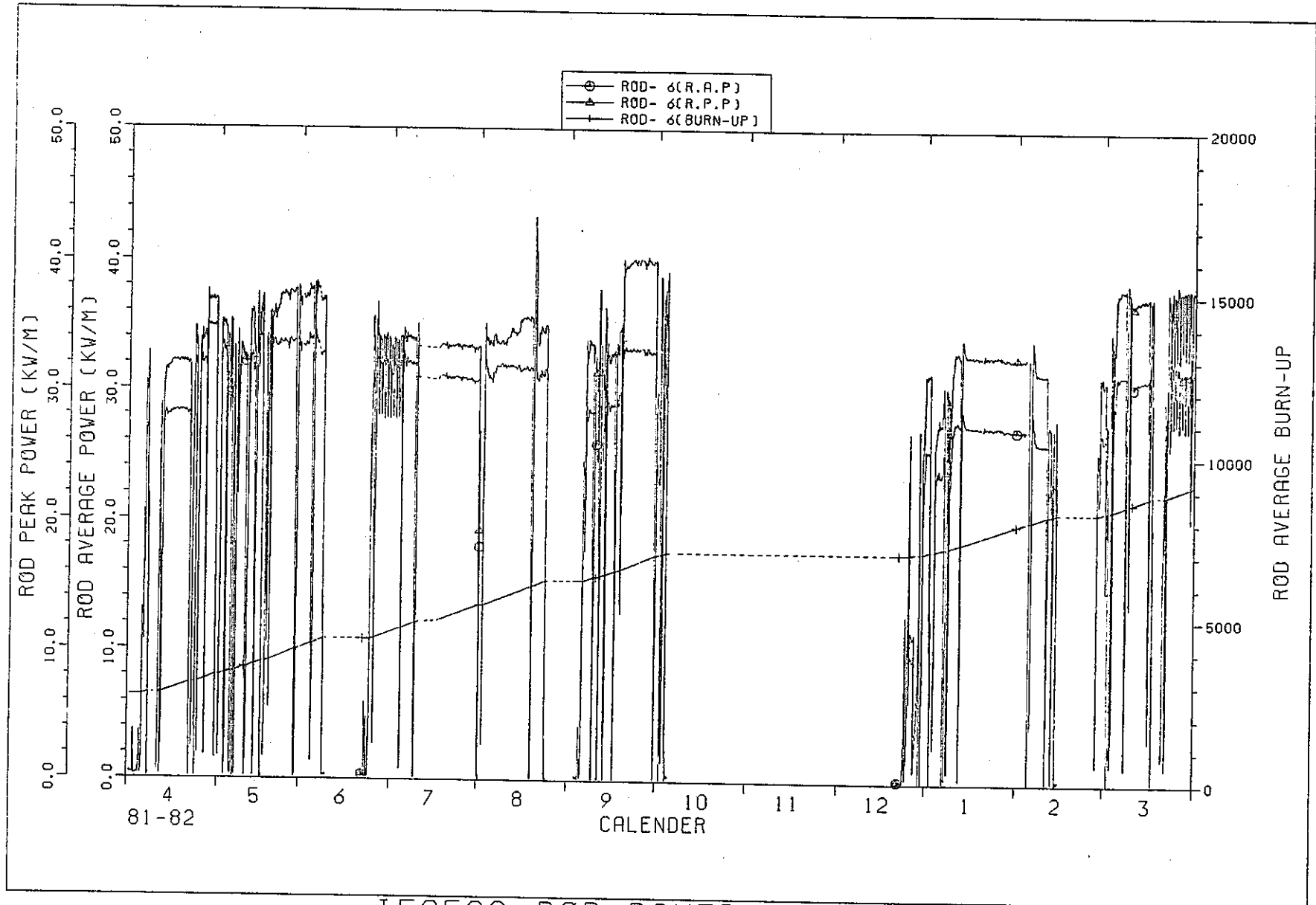

IFA529 ROD POWER HISTORY

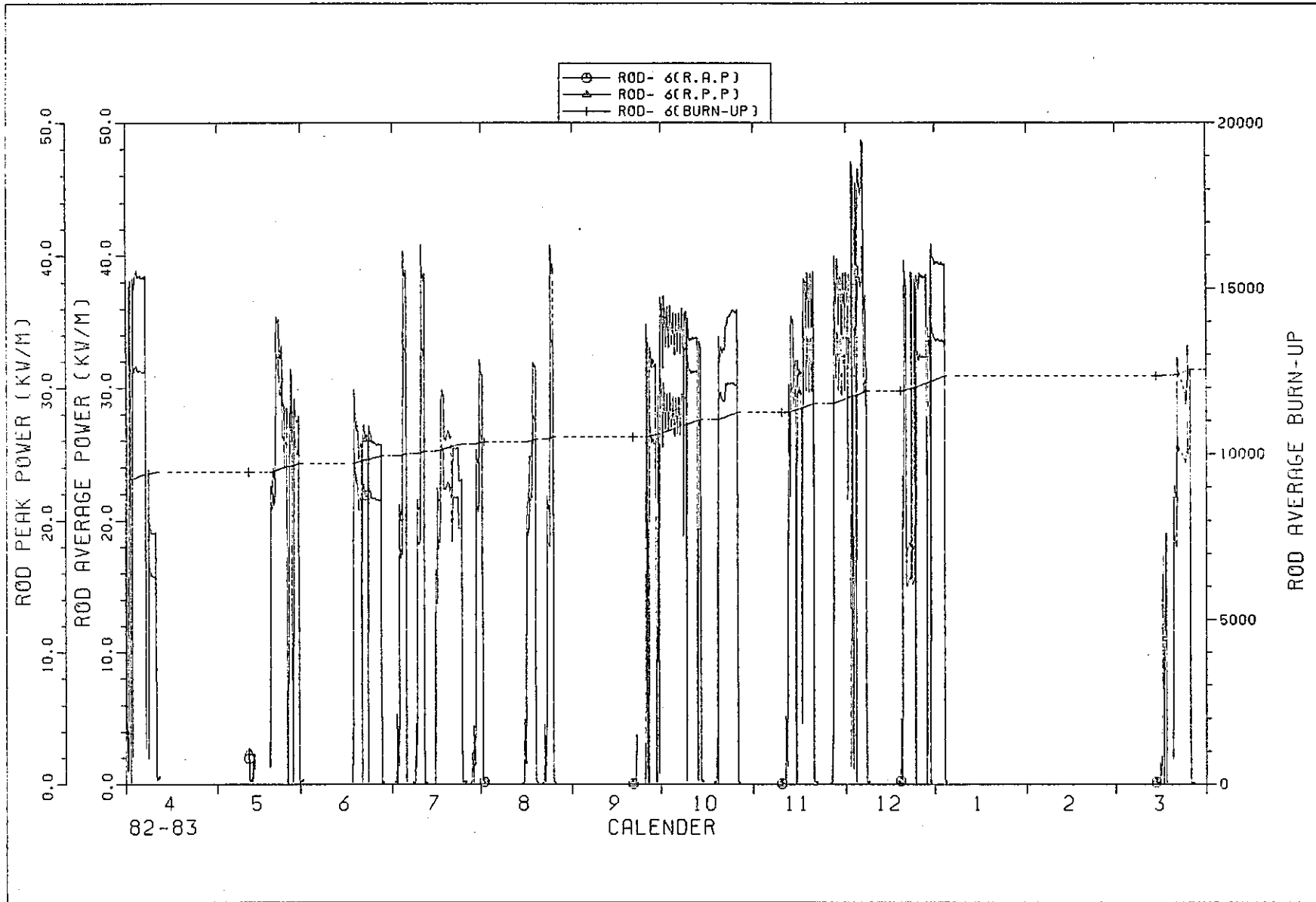

IFA529 ROD POWER HISTORY

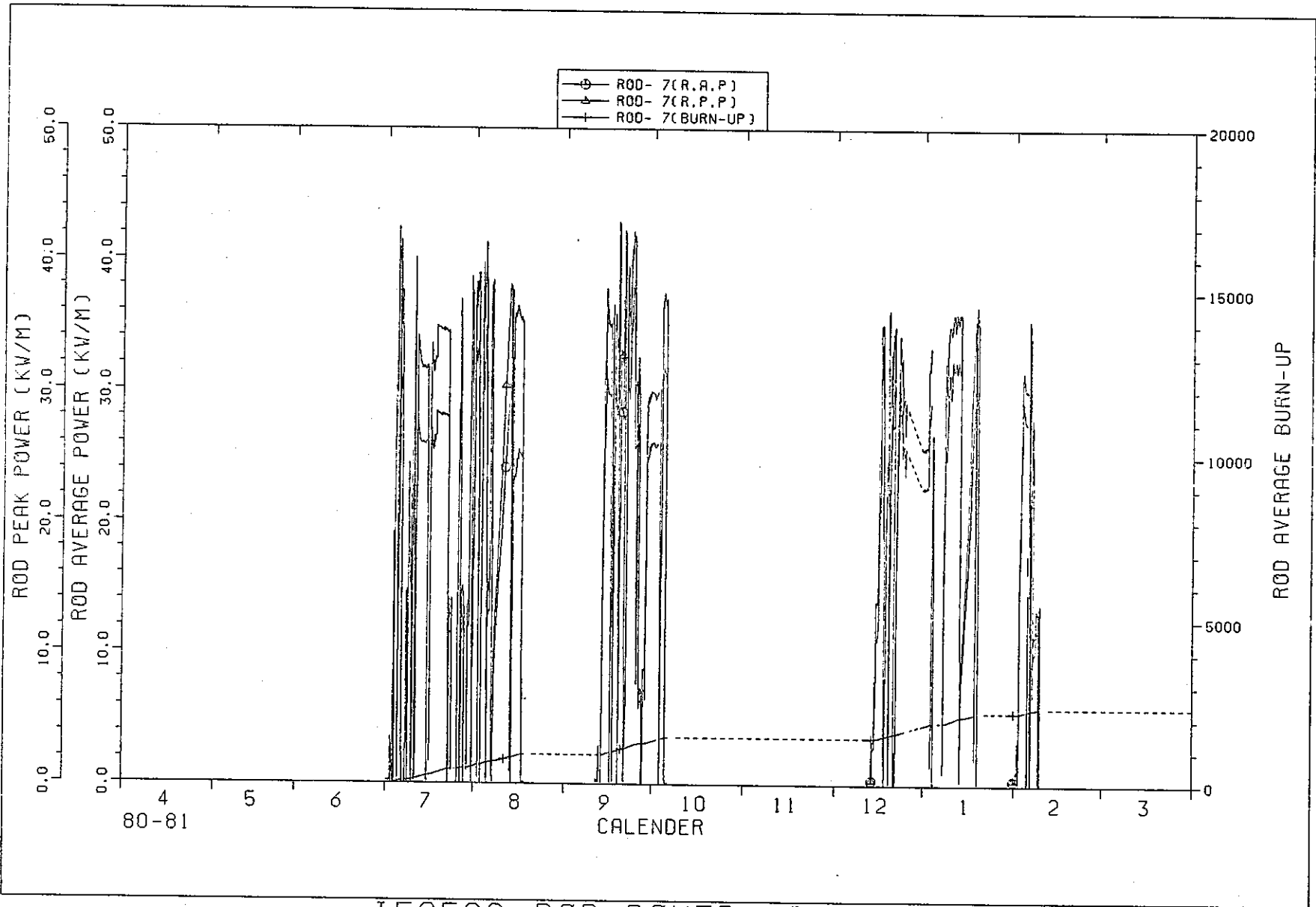

IFA529 ROD POWER HISTORY

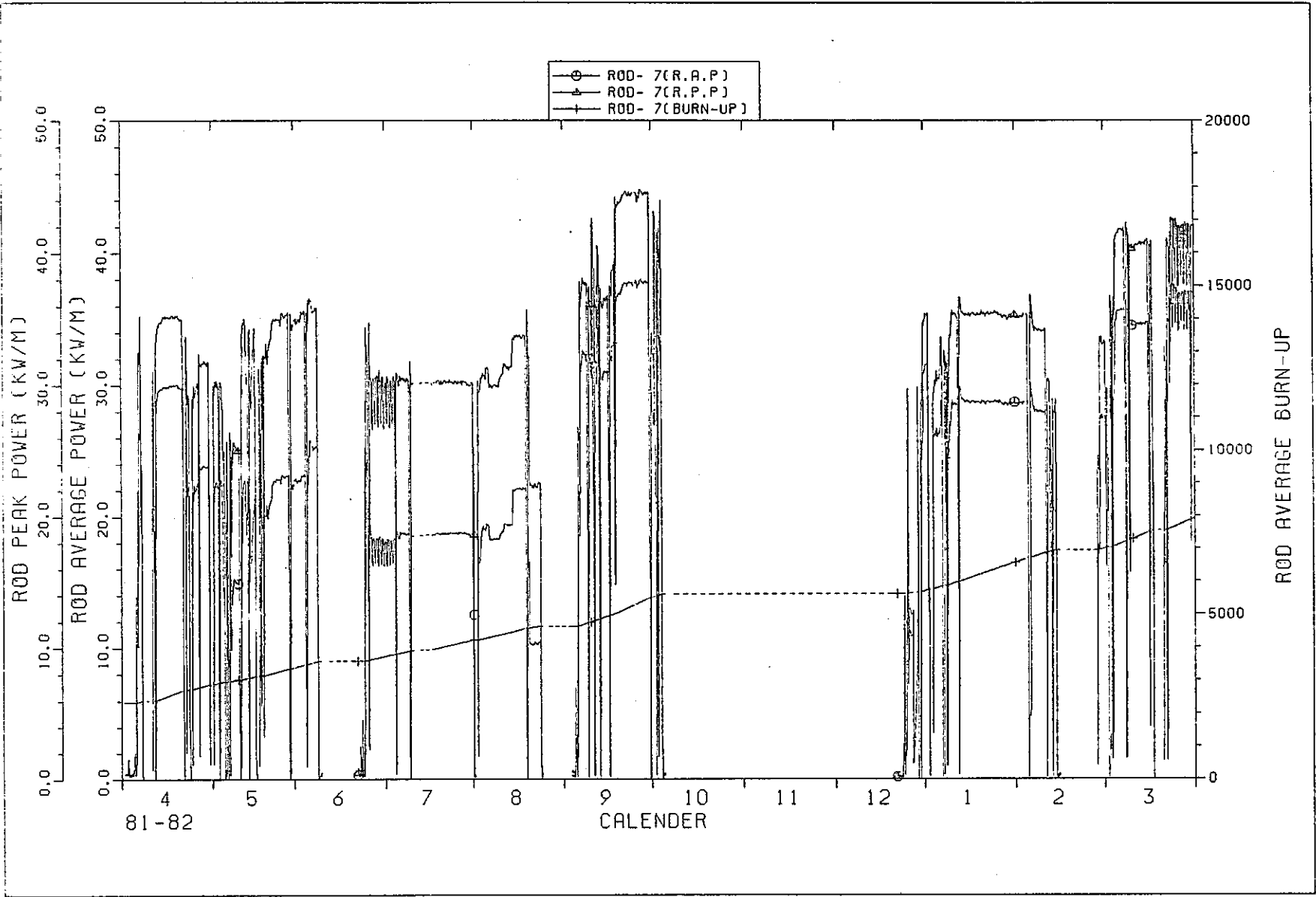

IFA529 ROD POWER HISTORY

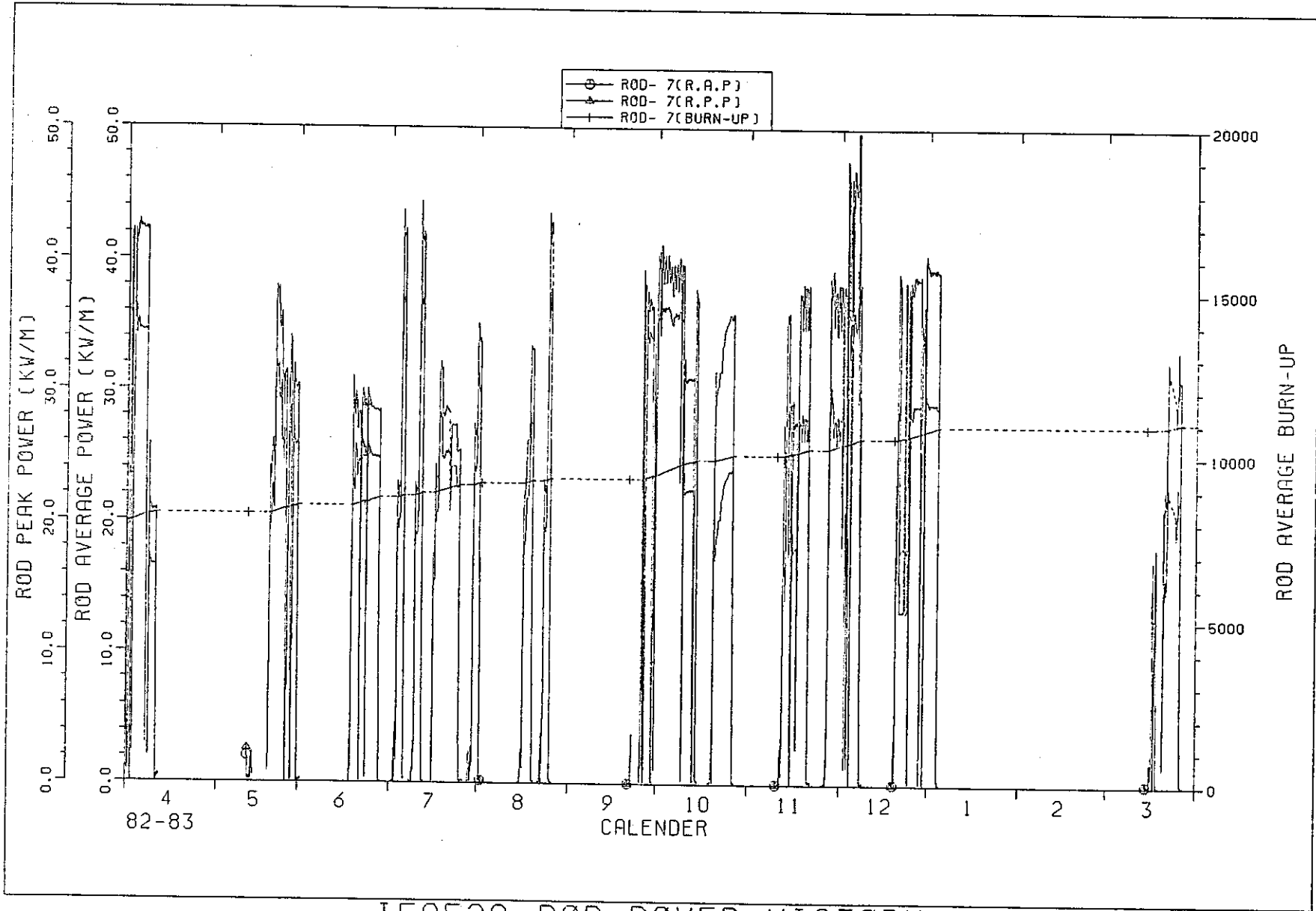

IFA529 ROD POWER HISTORY

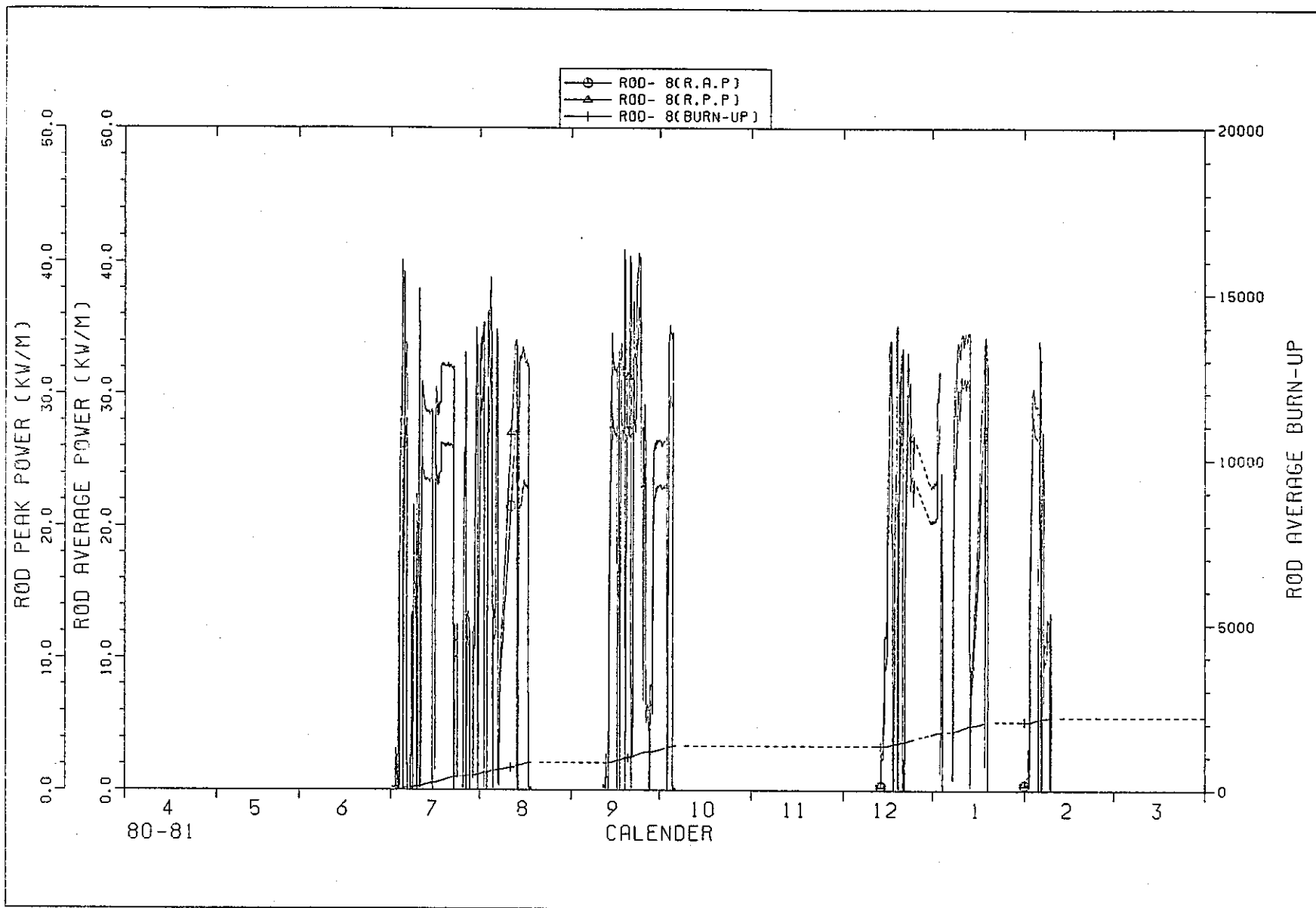

IFA529 ROD POWER HISTORY

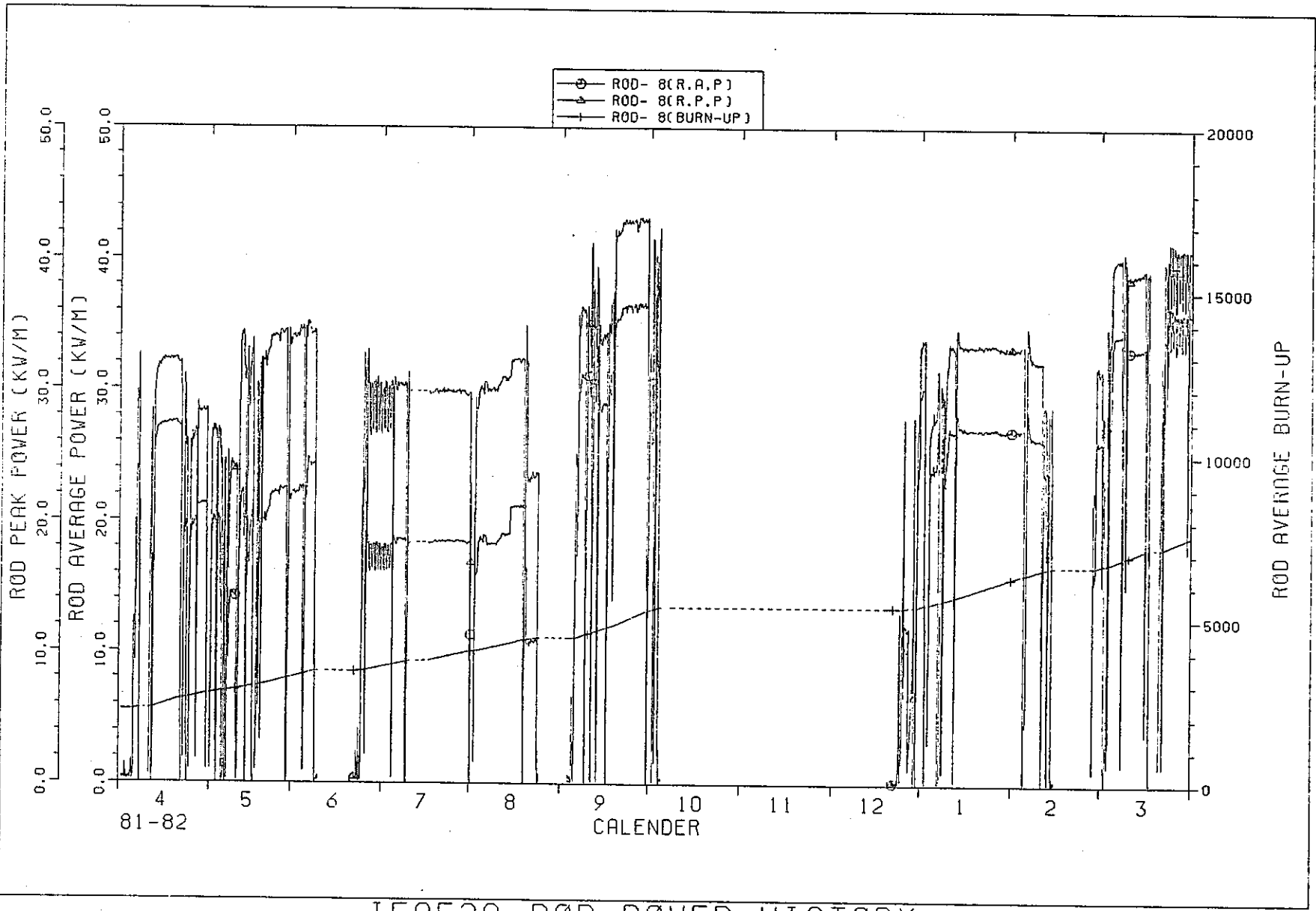

IFA529 ROD POWER HISTORY

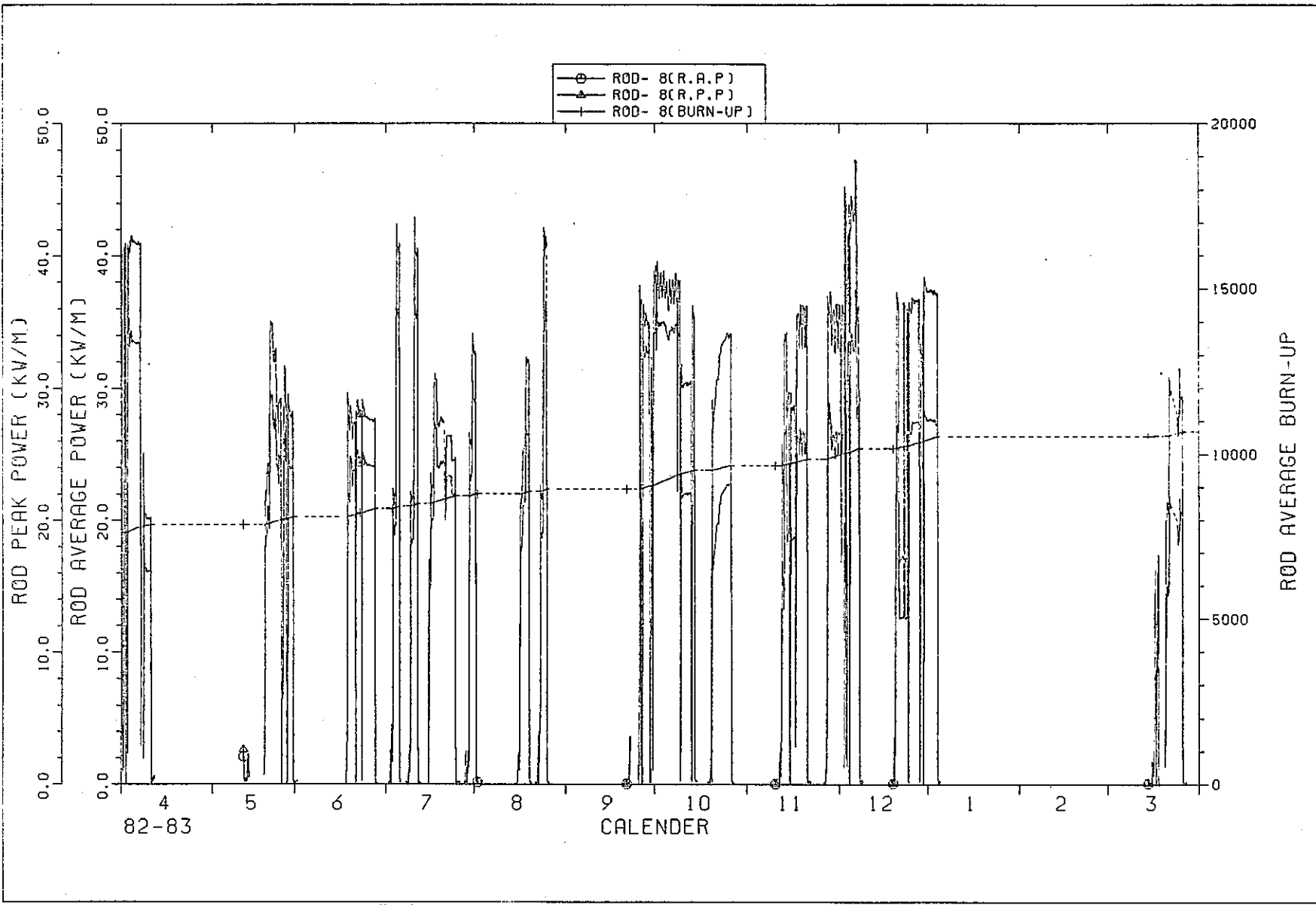

IFA529 ROD POWER HISTORY

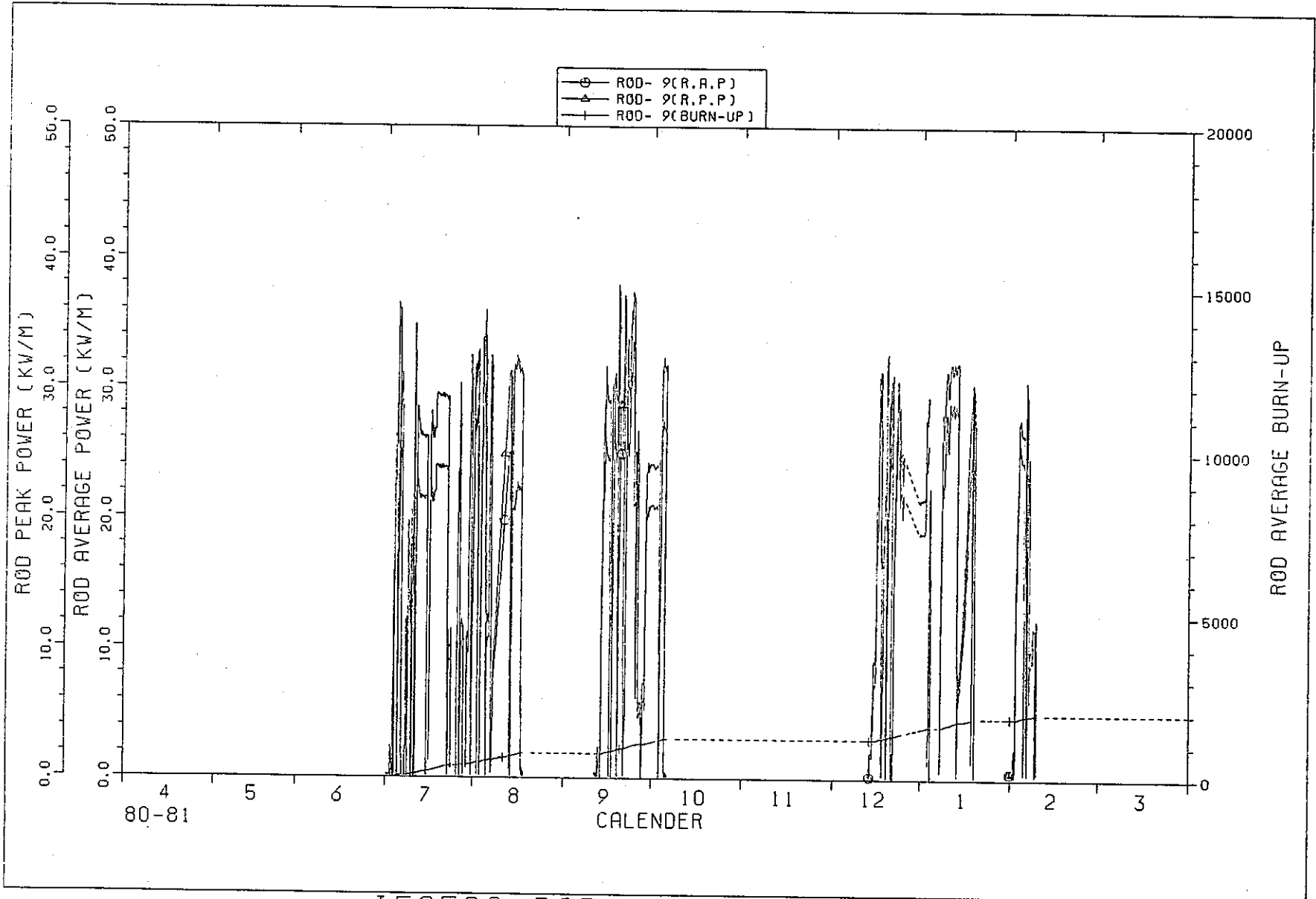

IFA529 ROD POWER HISTORY

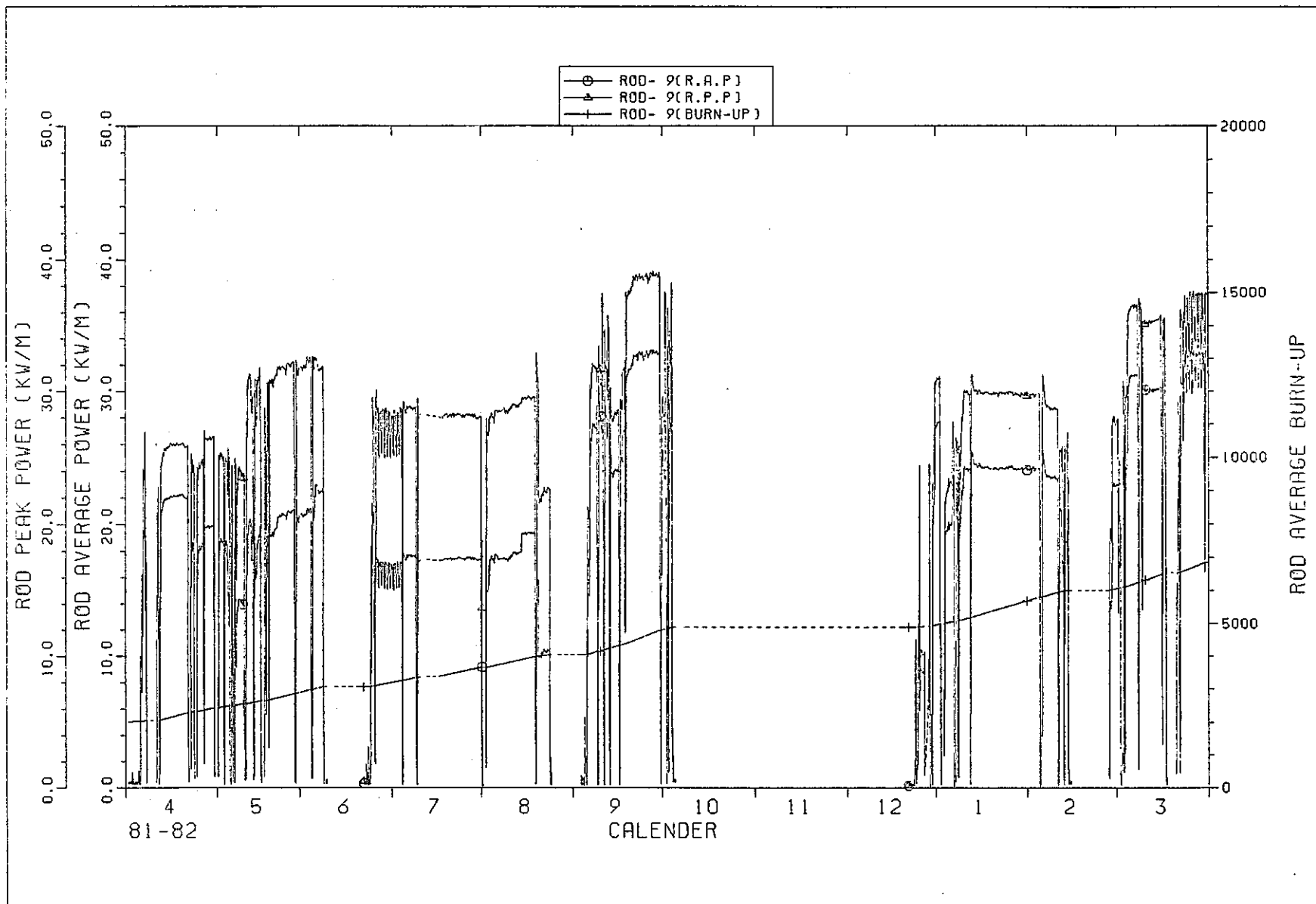

IFA529 ROD POWER HISTORY

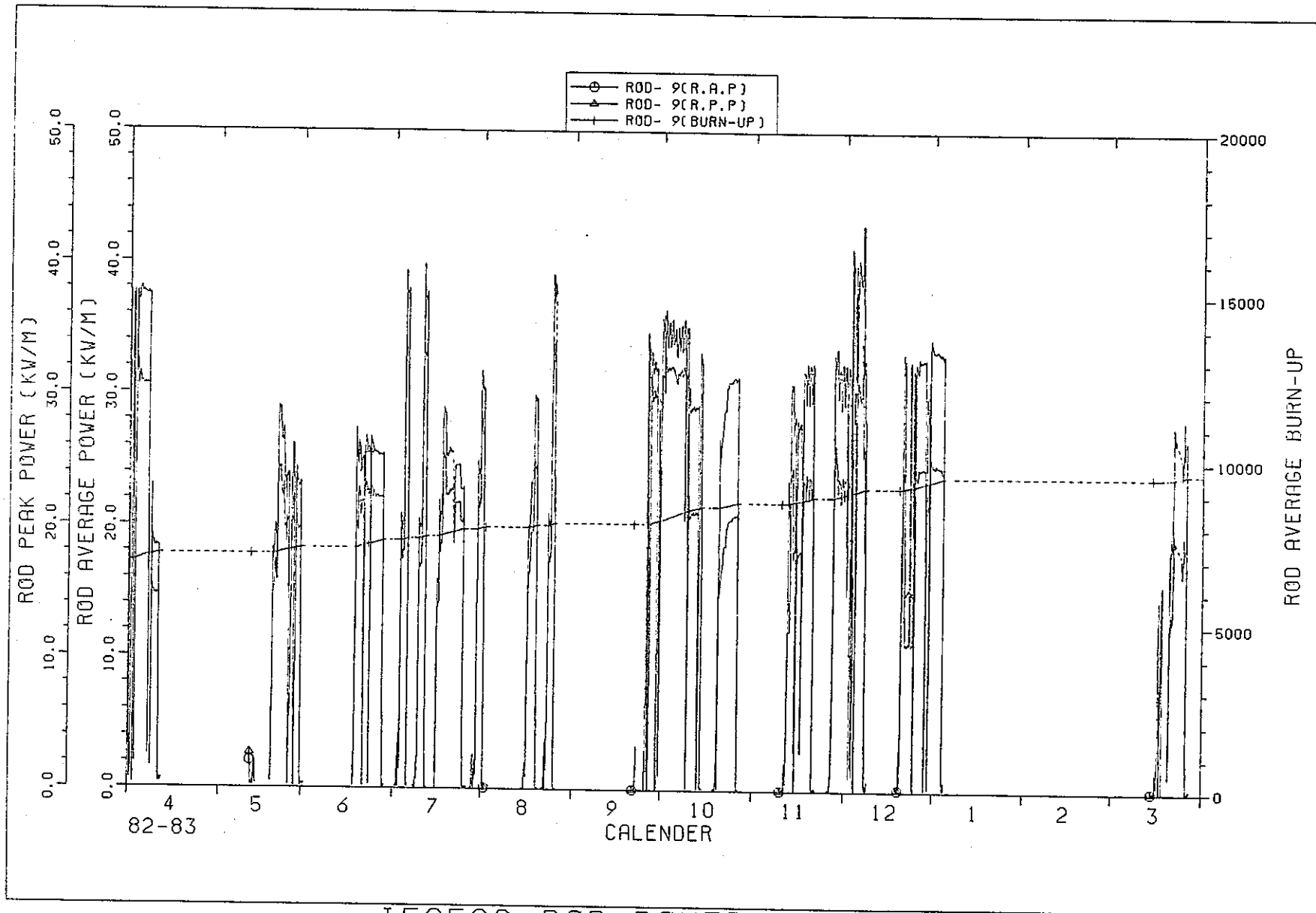

IFA529 ROD POWER HISTORY

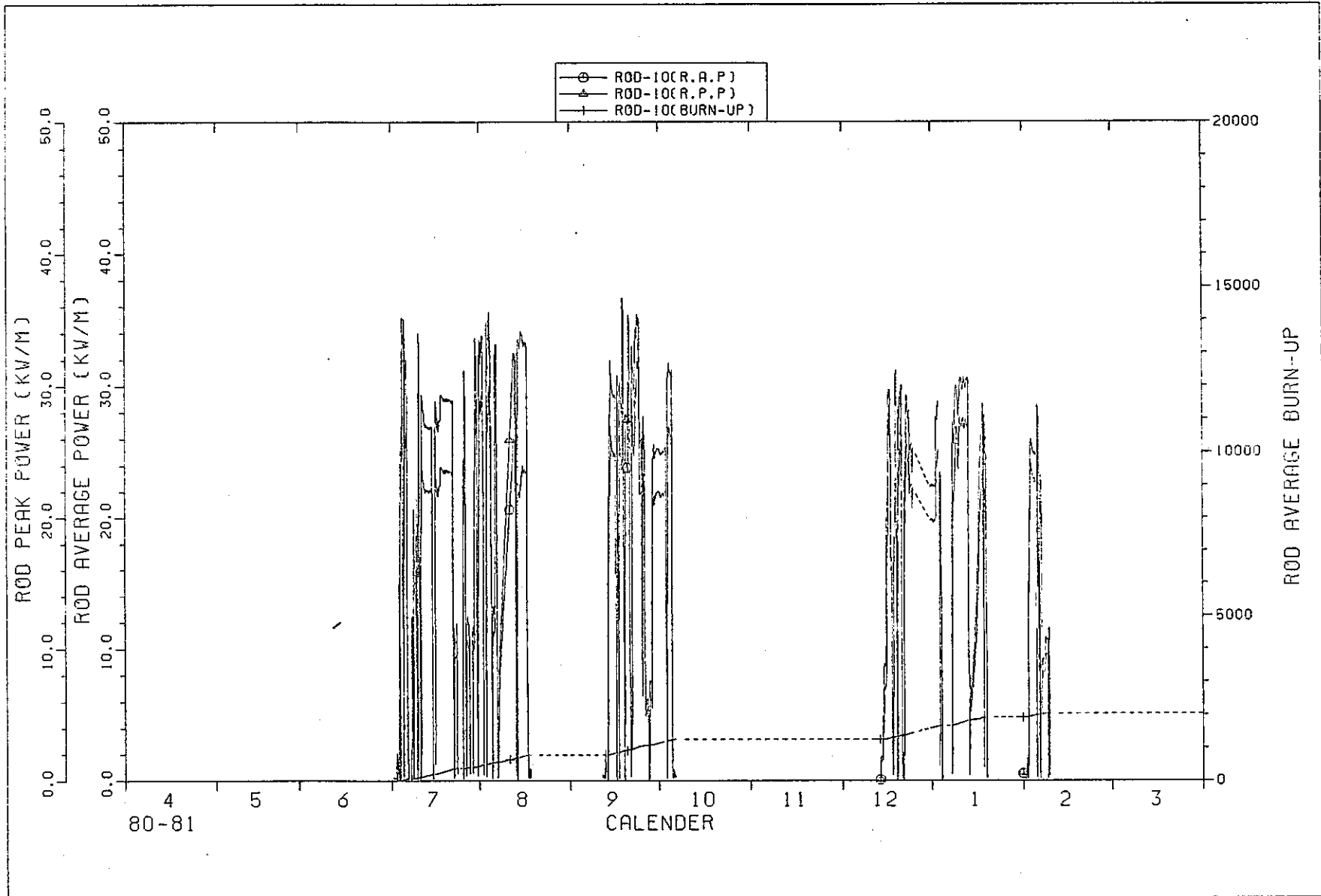

IFA529 ROD POWER HISTORY

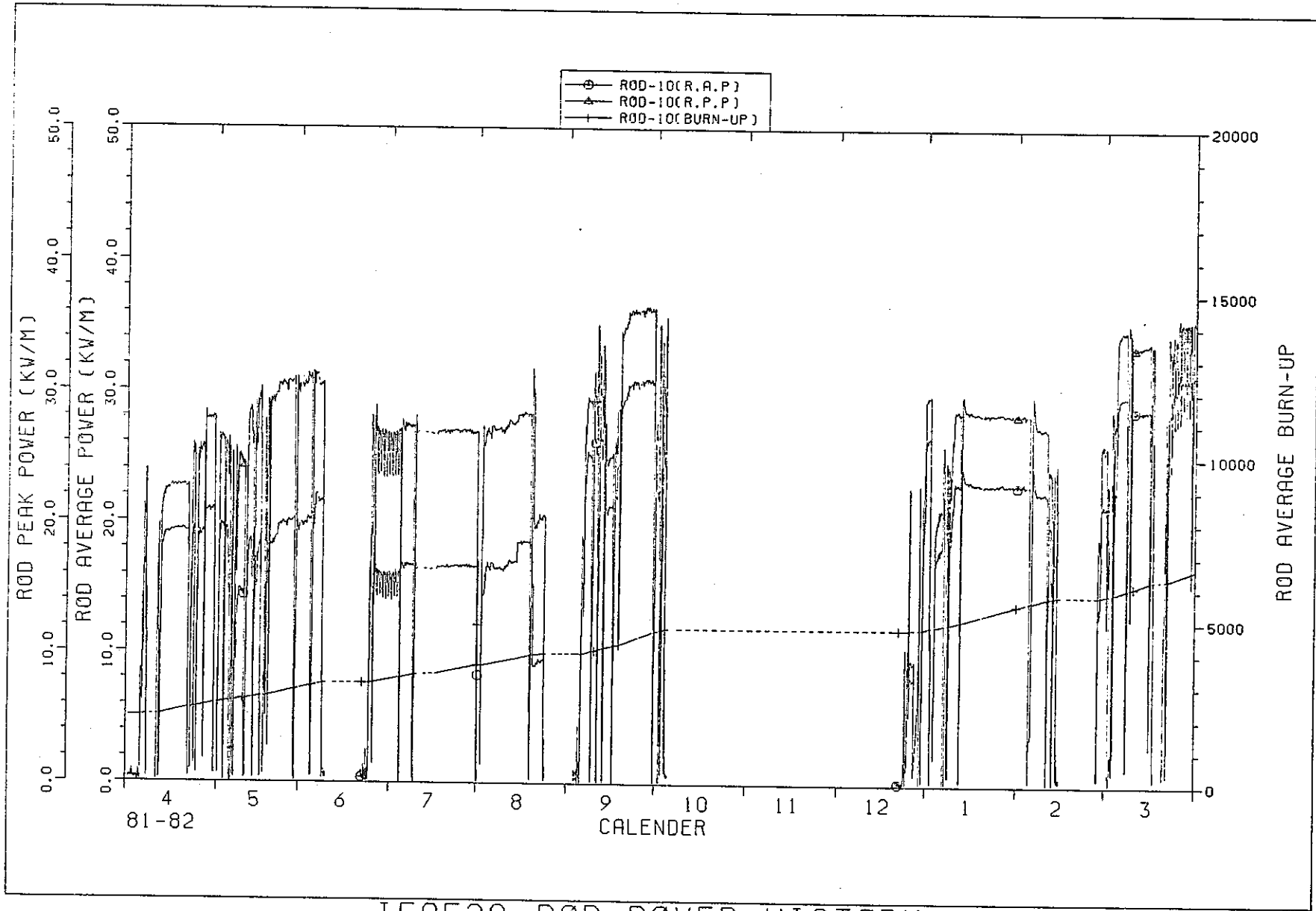

IFA529 ROD POWER HISTORY

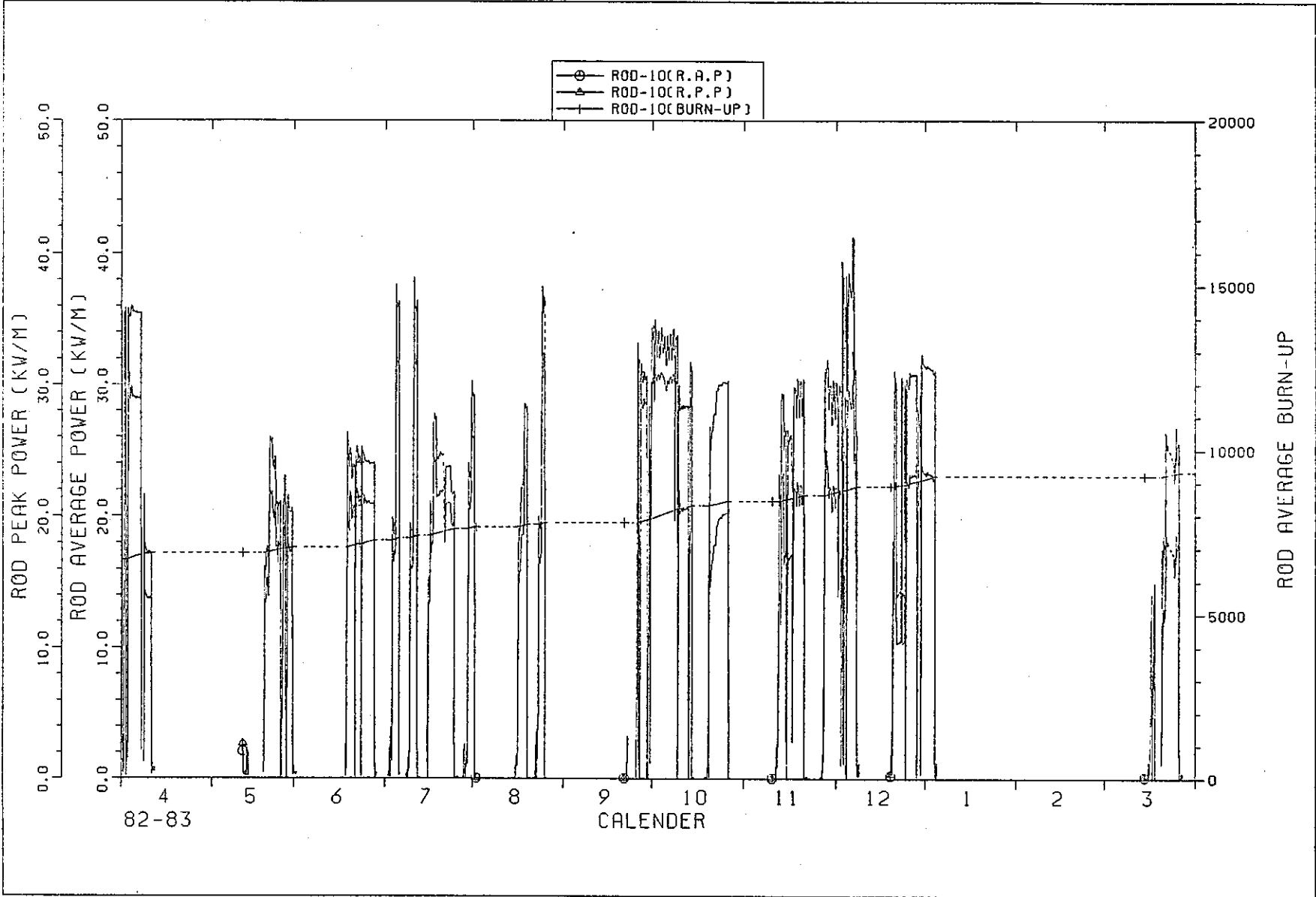

IFA529 ROD POWER HISTORY

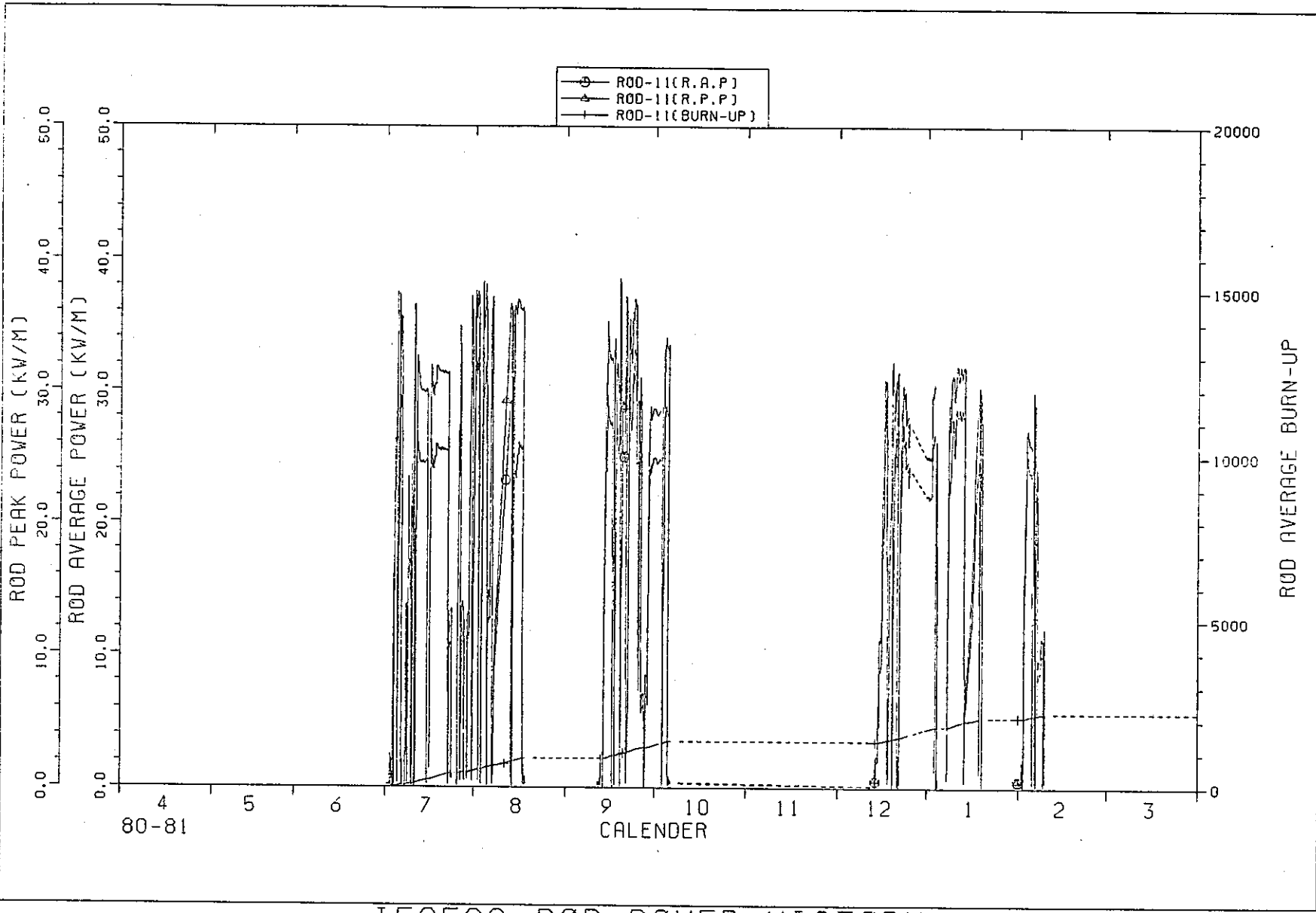

IFA529 ROD POWER HISTORY

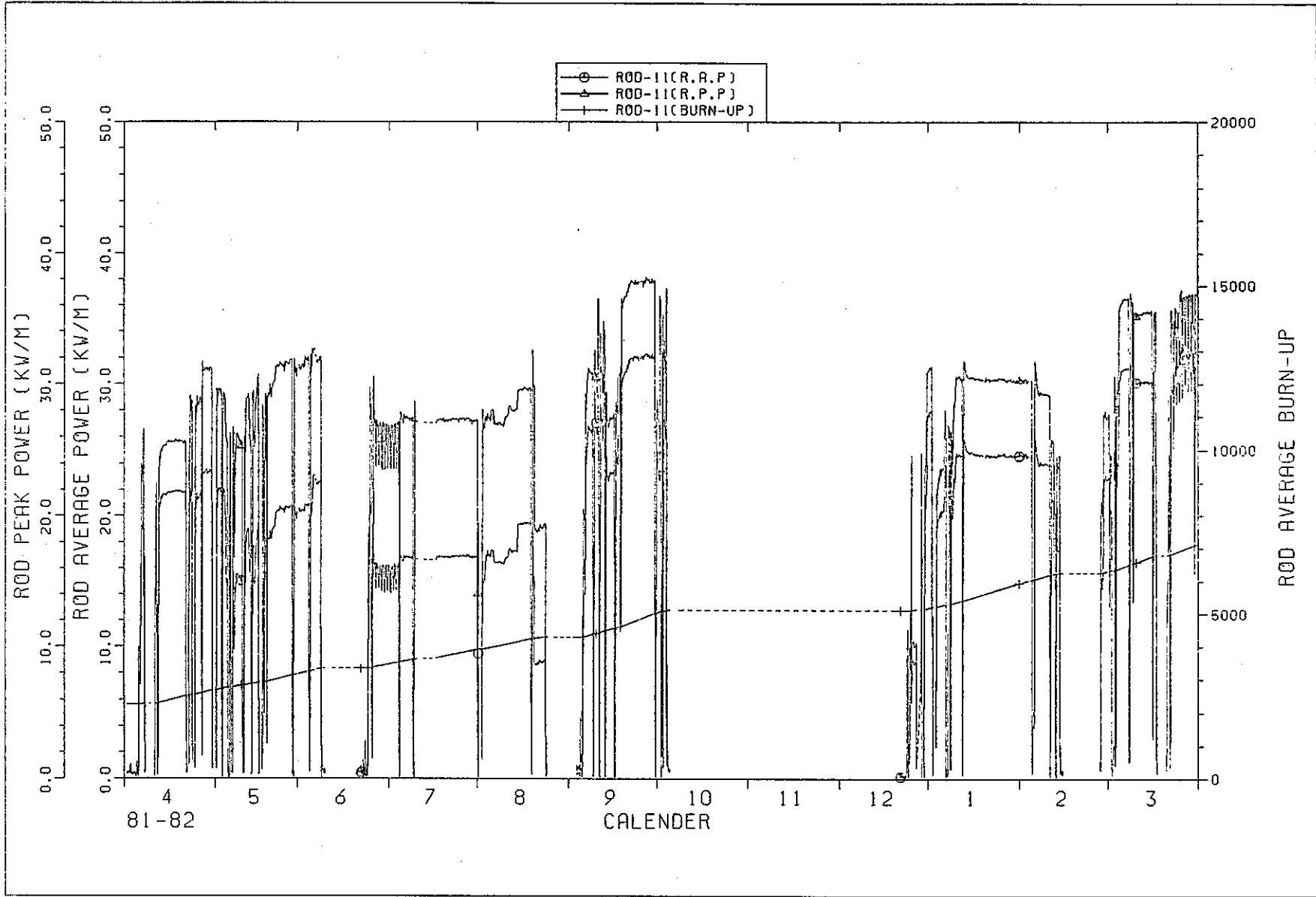

IFA529 ROD POWER HISTORY

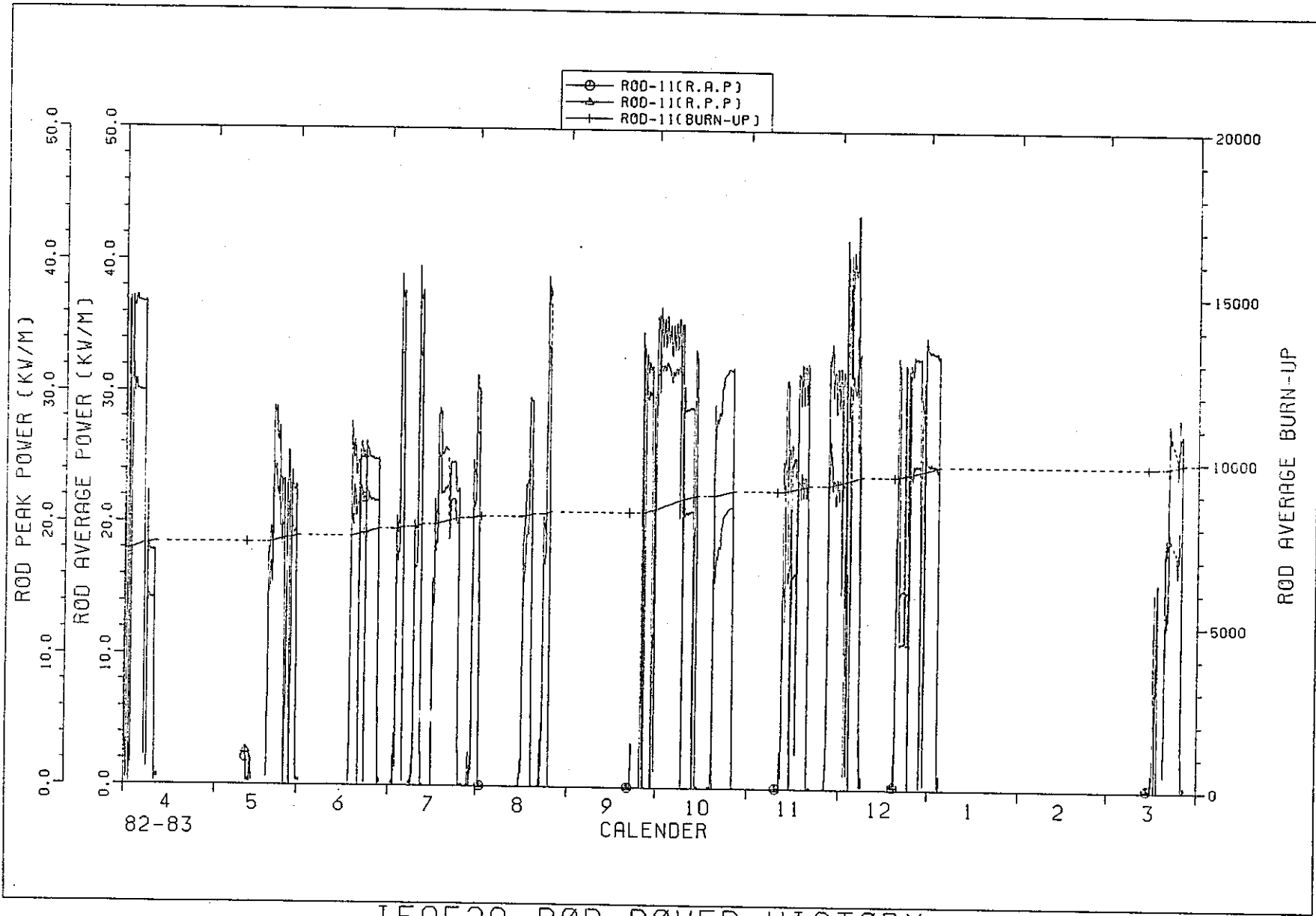

IFA529 ROD POWER HISTORY

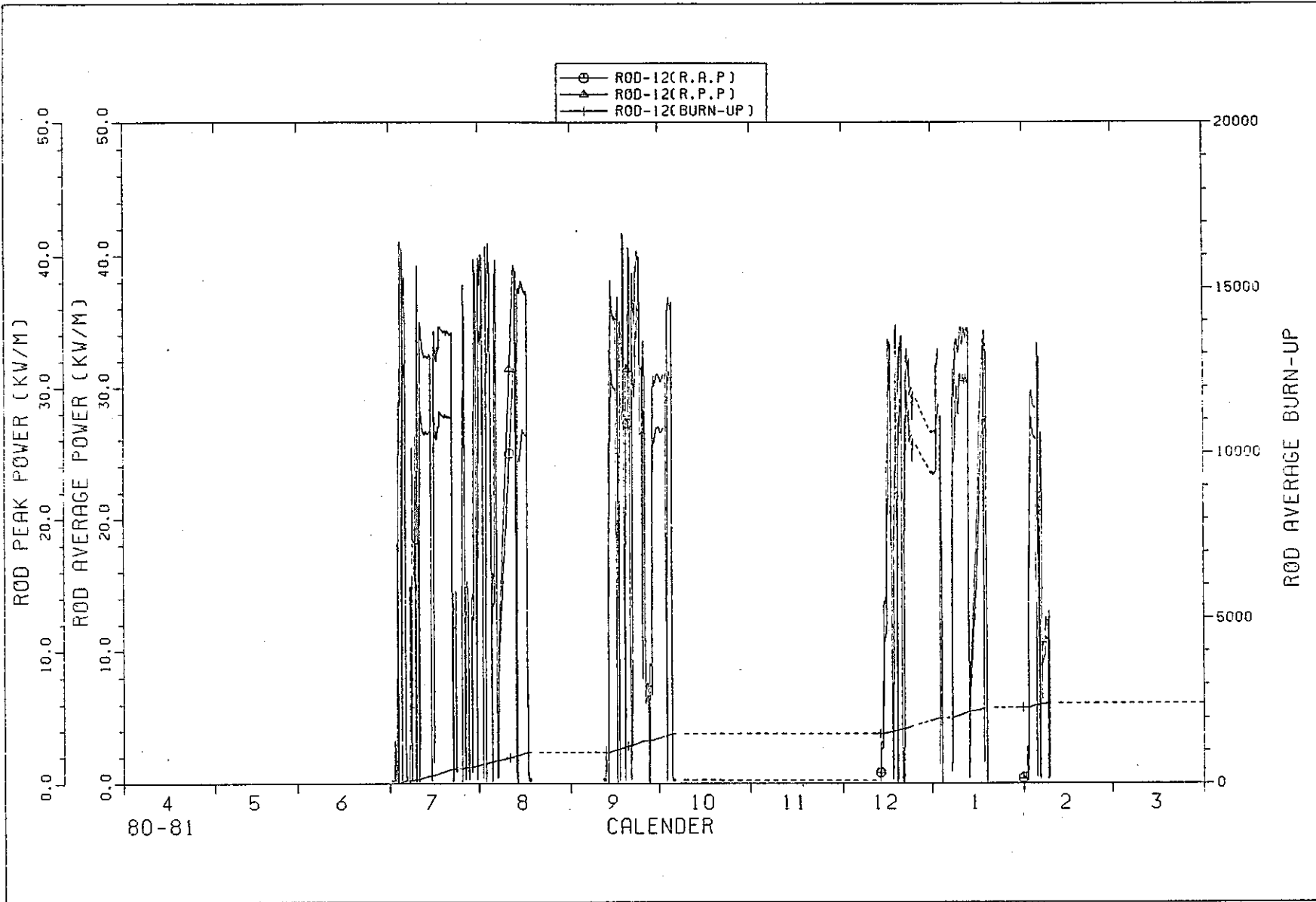

IFA529 ROD POWER HISTORY

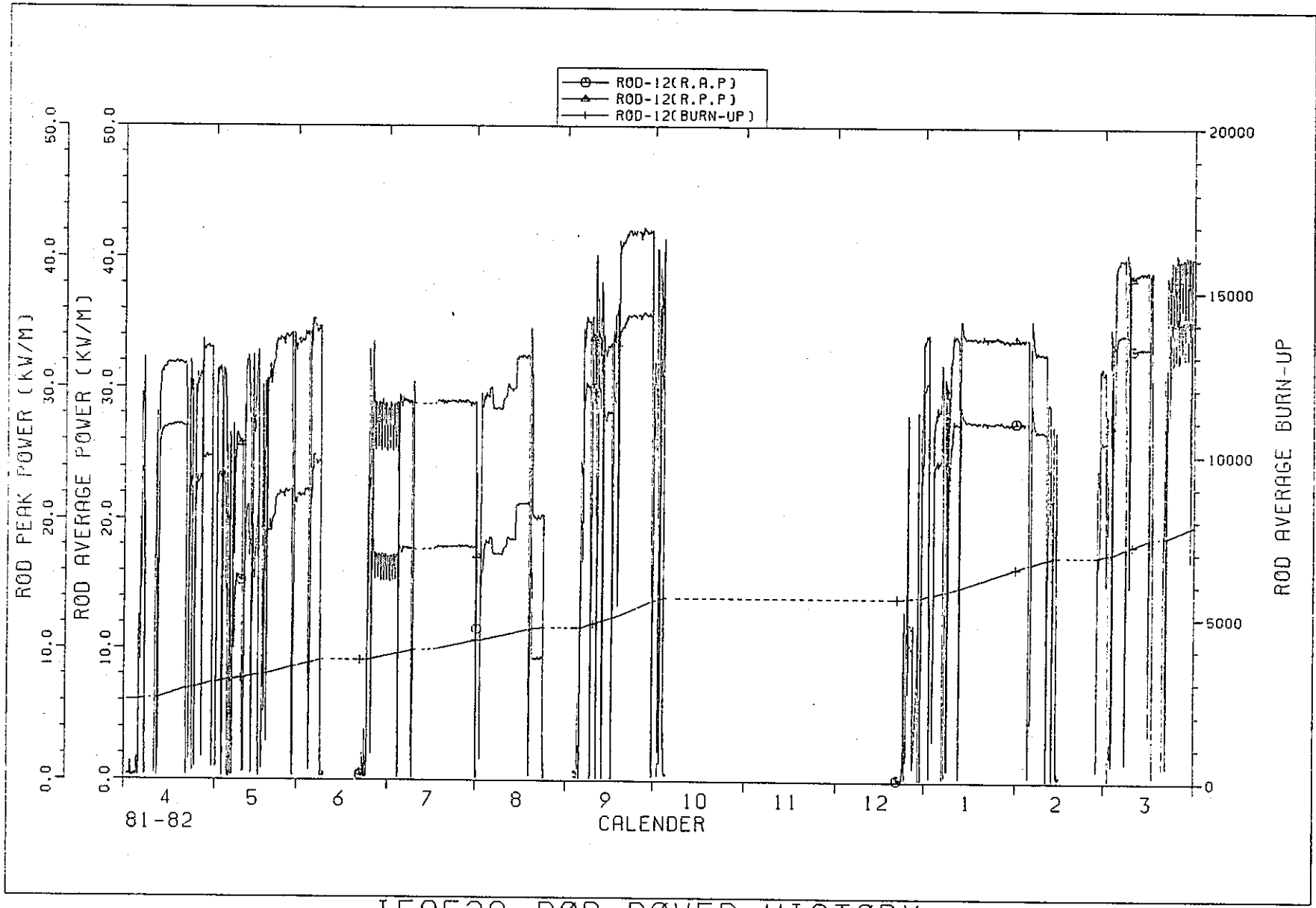

IFA529 ROD POWER HISTORY

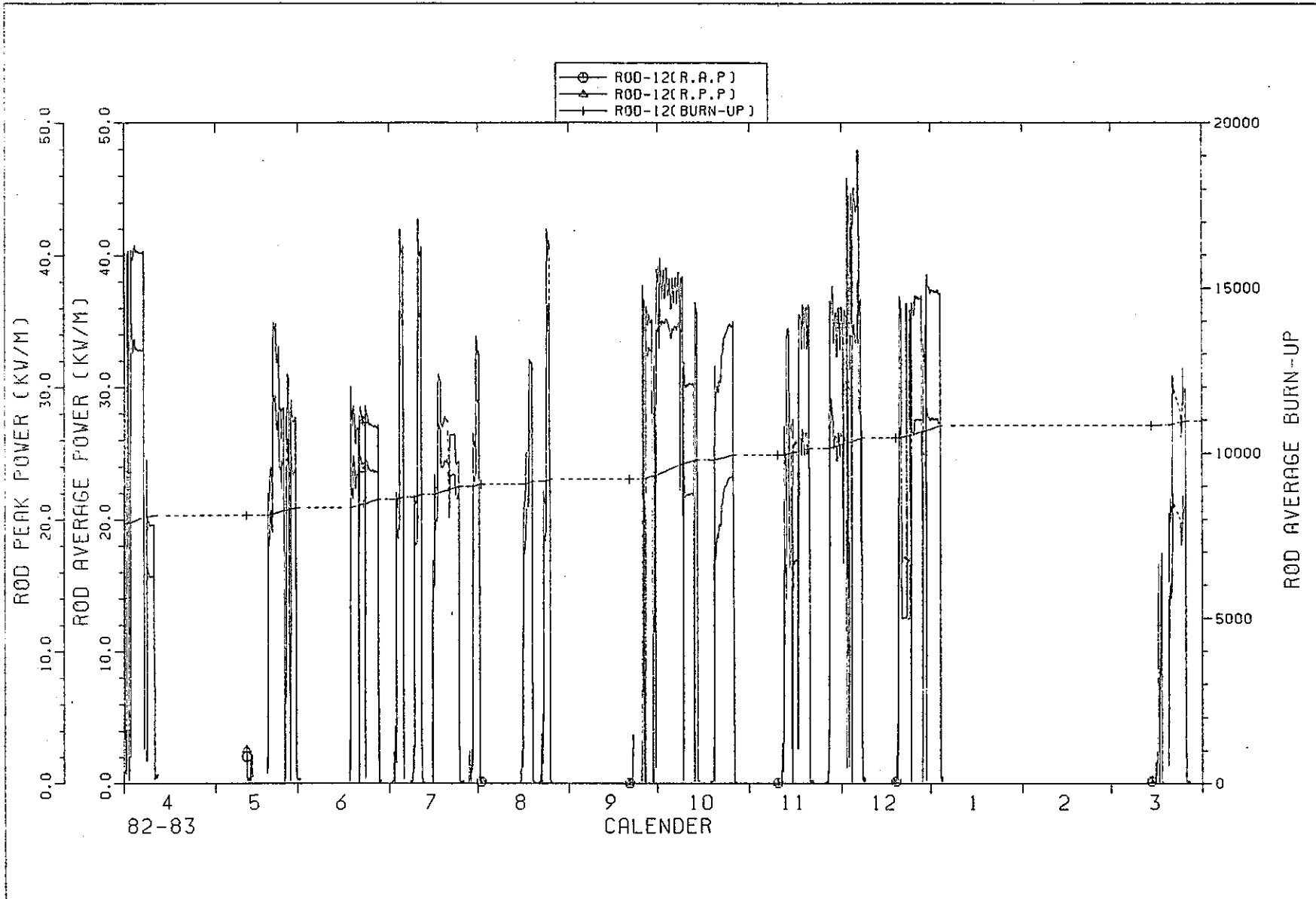

IFA529 ROD POWER HISTORY

付 録 2

I F A - 529 各燃料棒の月別の線出力履歴

(1980年7月～1983年1月)

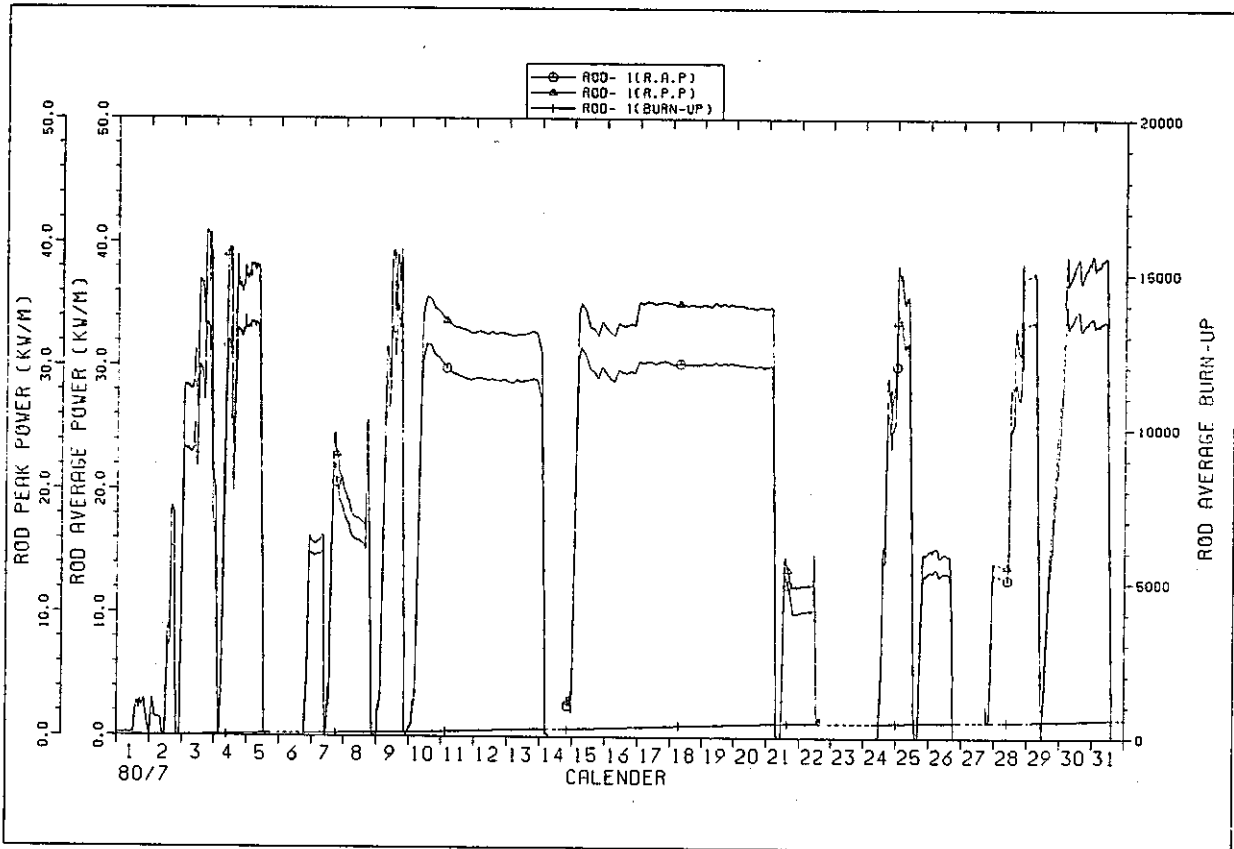

IFA529 ROD POWER HISTORY

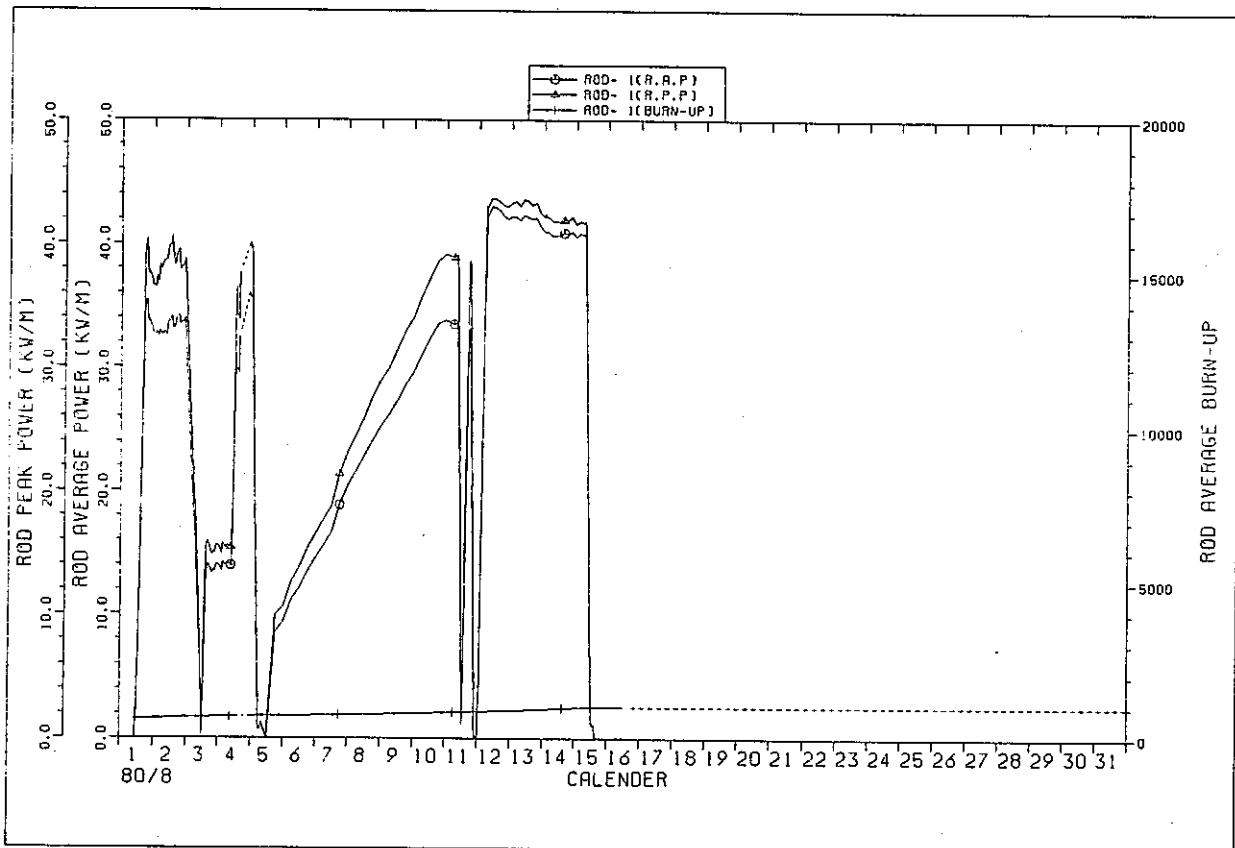

IFA529 ROD POWER HISTORY

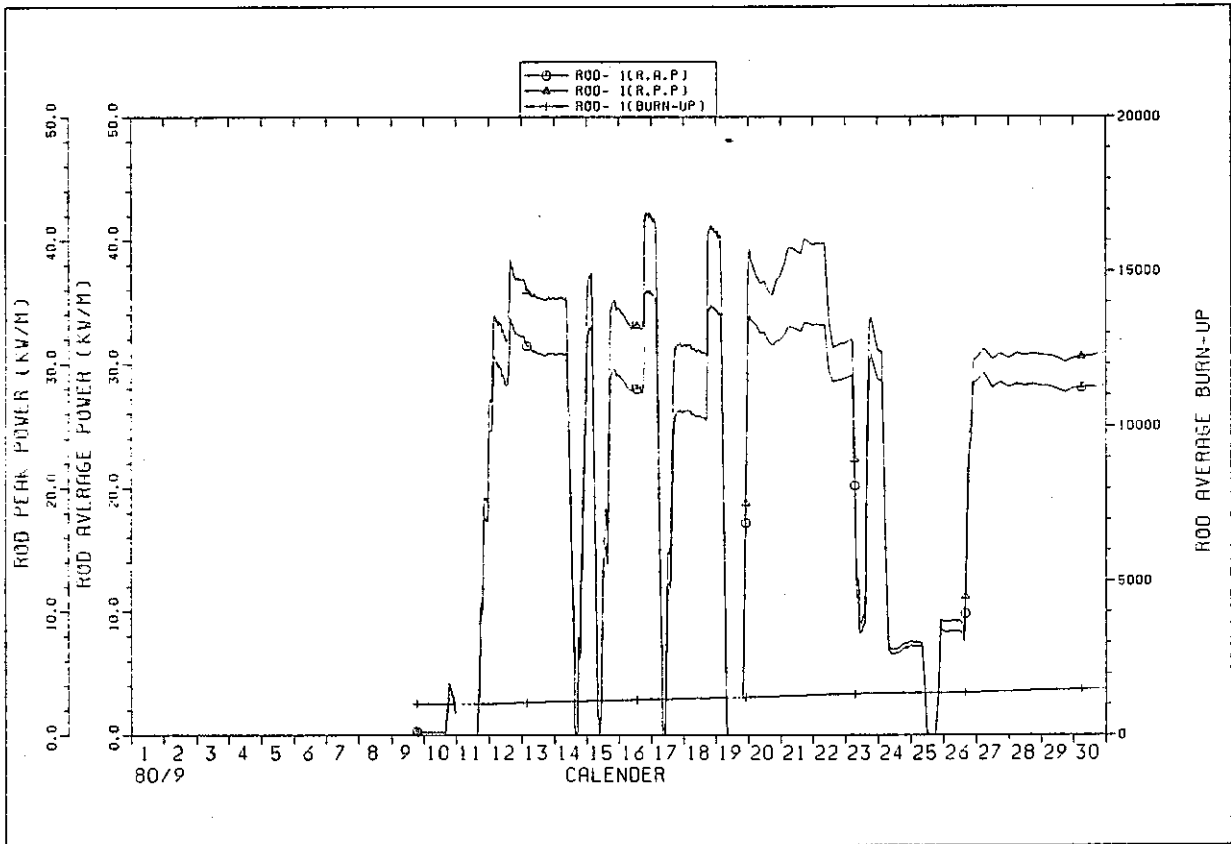

IFA529 ROD POWER HISTORY

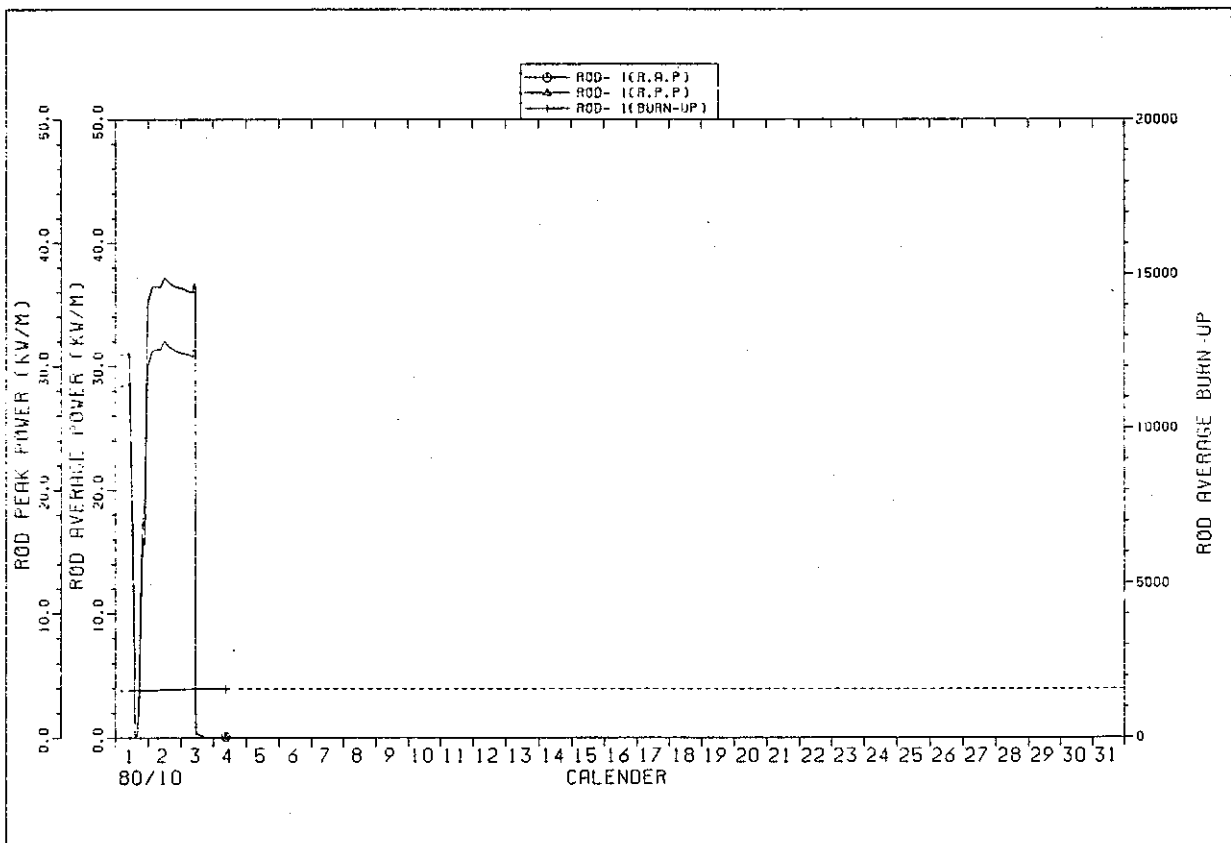

IFA529 ROD POWER HISTORY

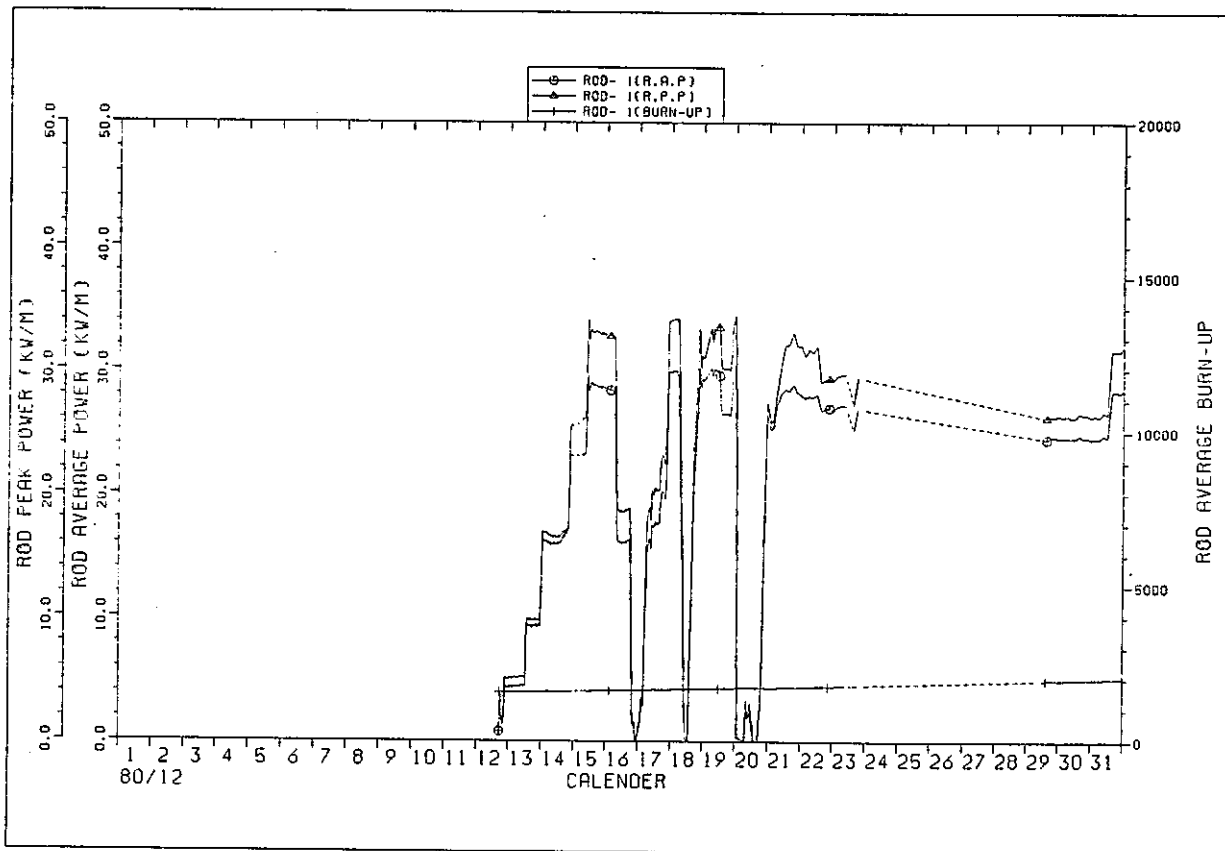

IFA529 ROD POWER HISTORY

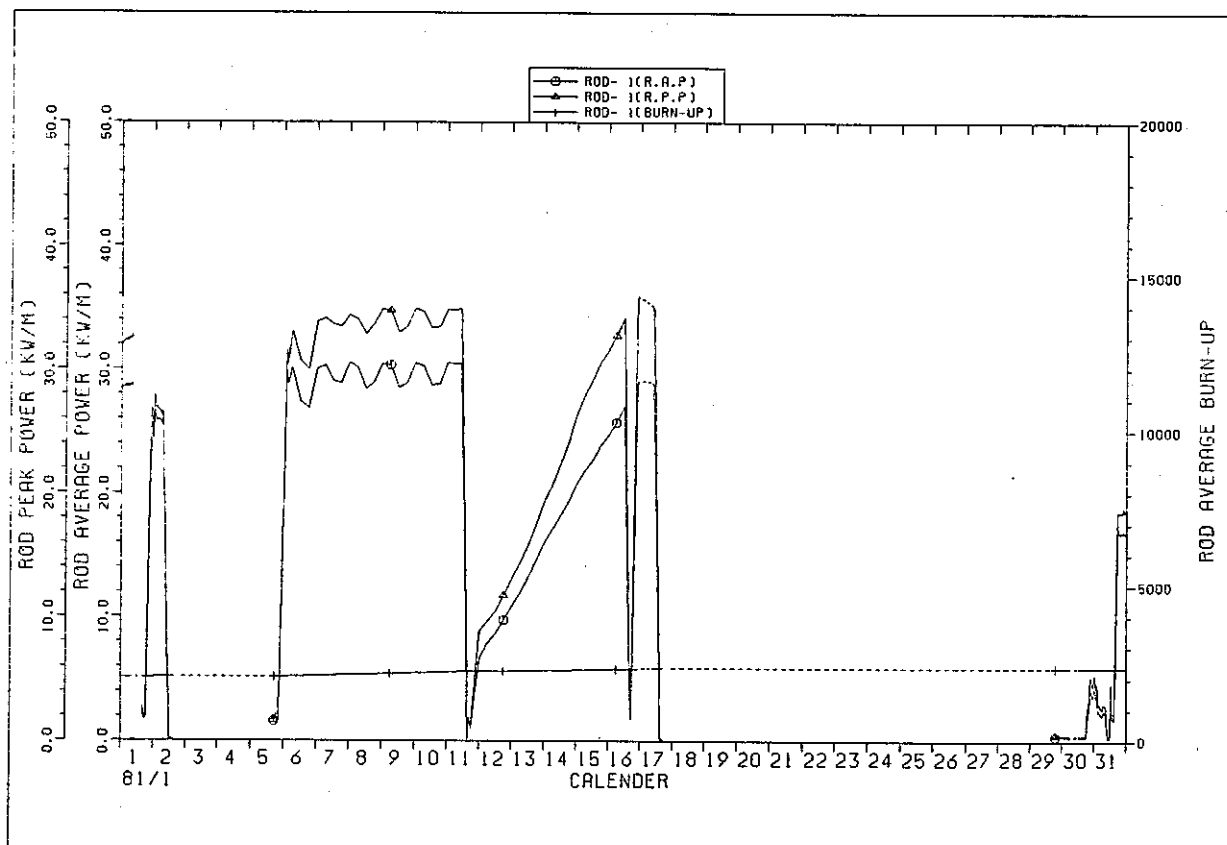

IFA529 ROD POWER HISTORY

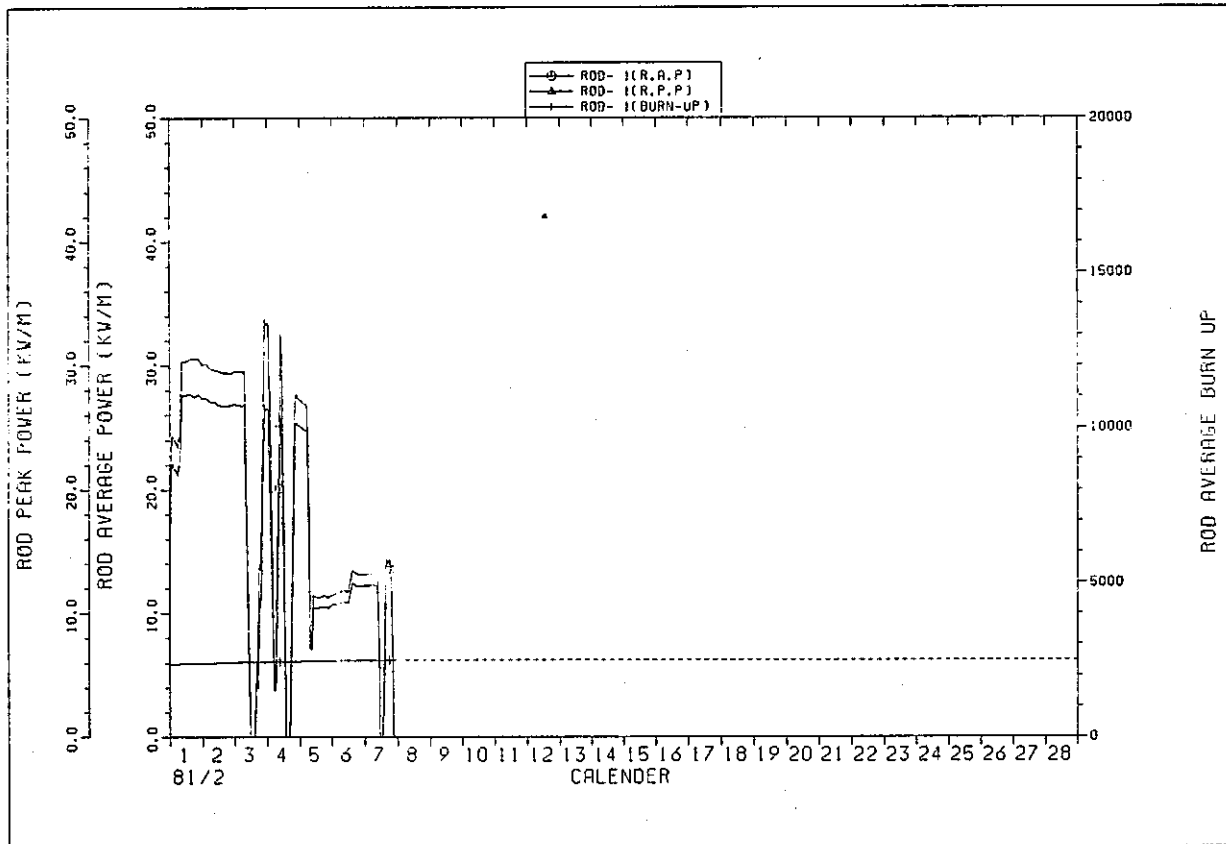

IFA529 ROD POWER HISTORY

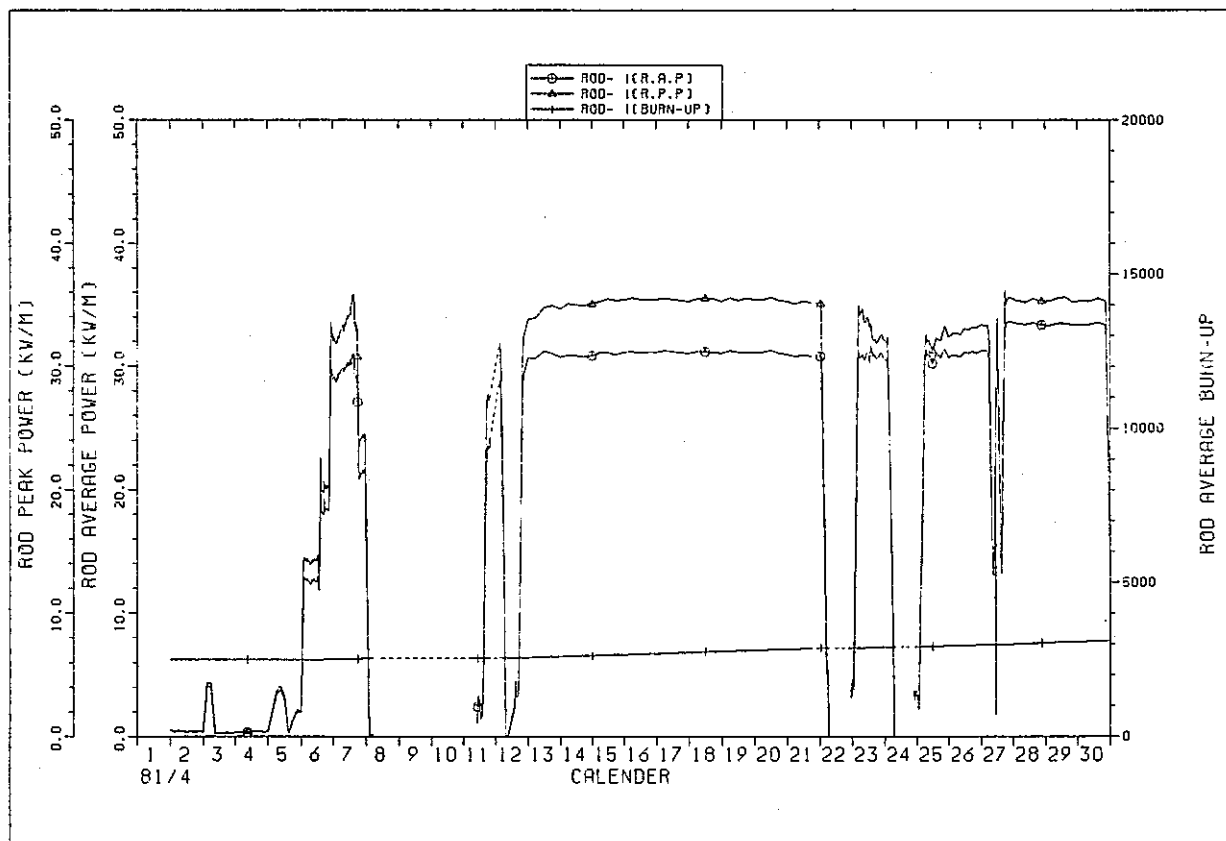

IFA529 ROD POWER HISTORY

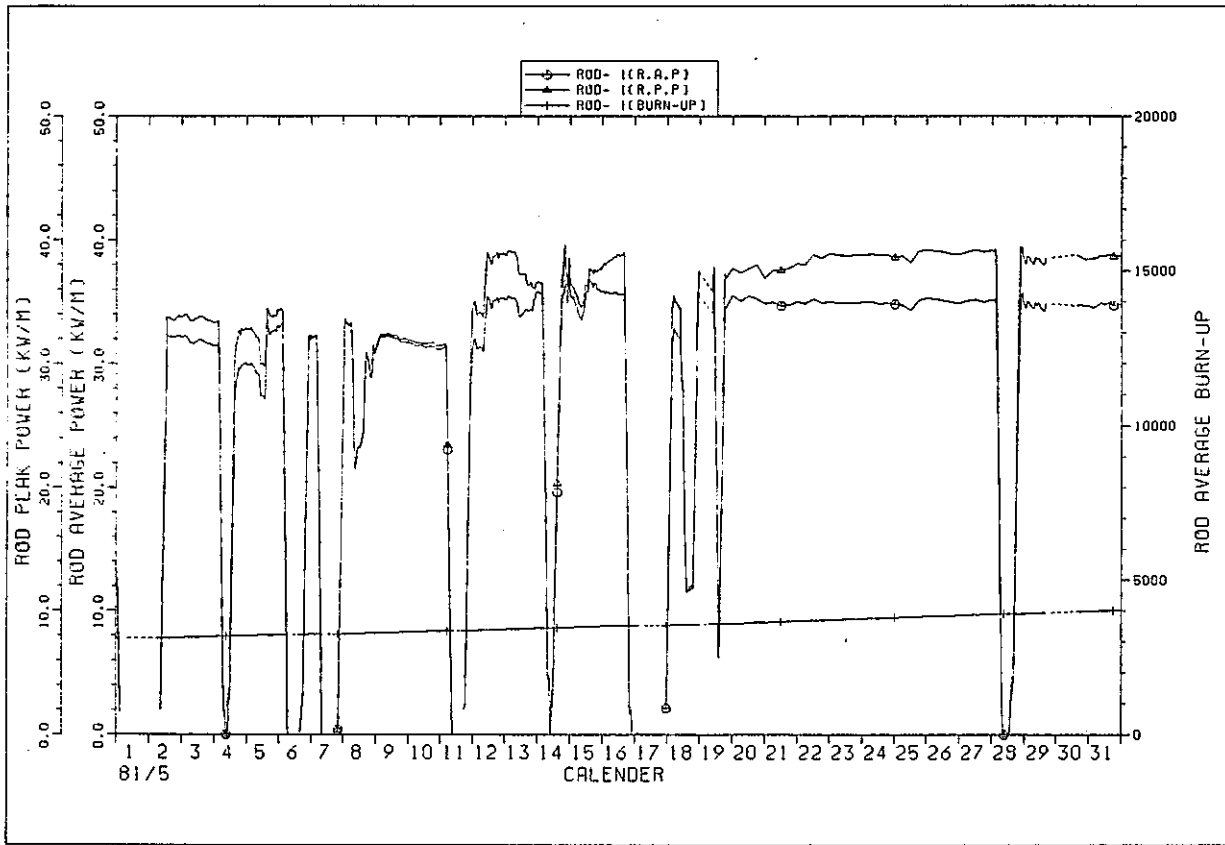

IFA529 ROD POWER HISTORY

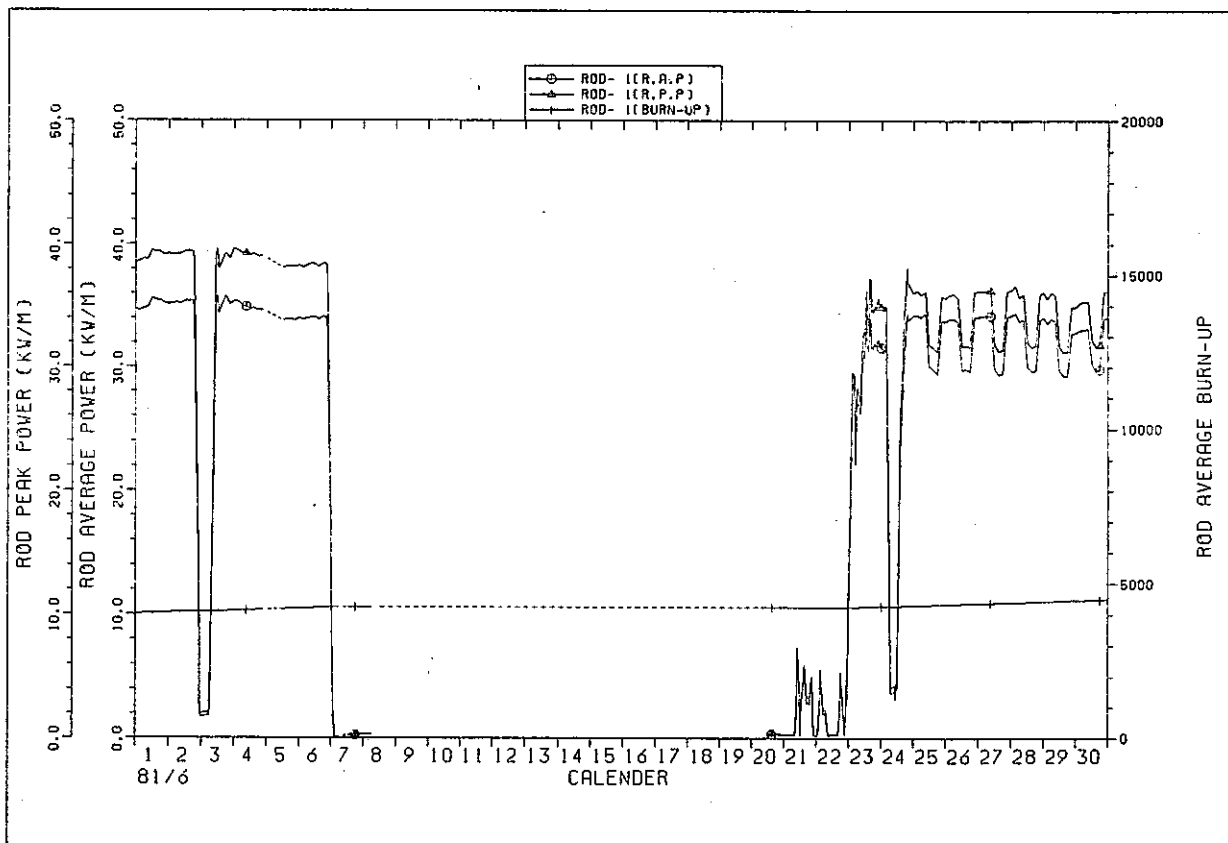

IFA529 ROD POWER HISTORY

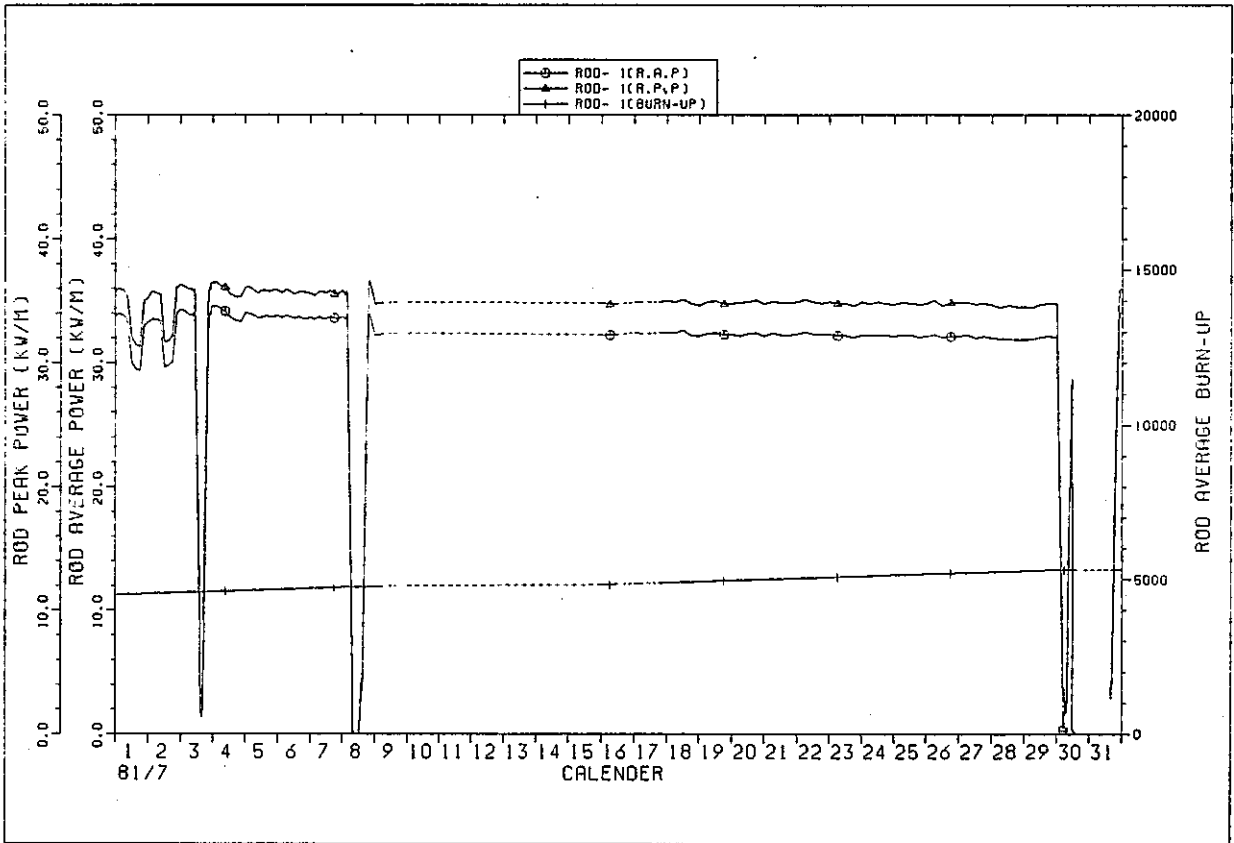

IFA529 ROD POWER HISTORY

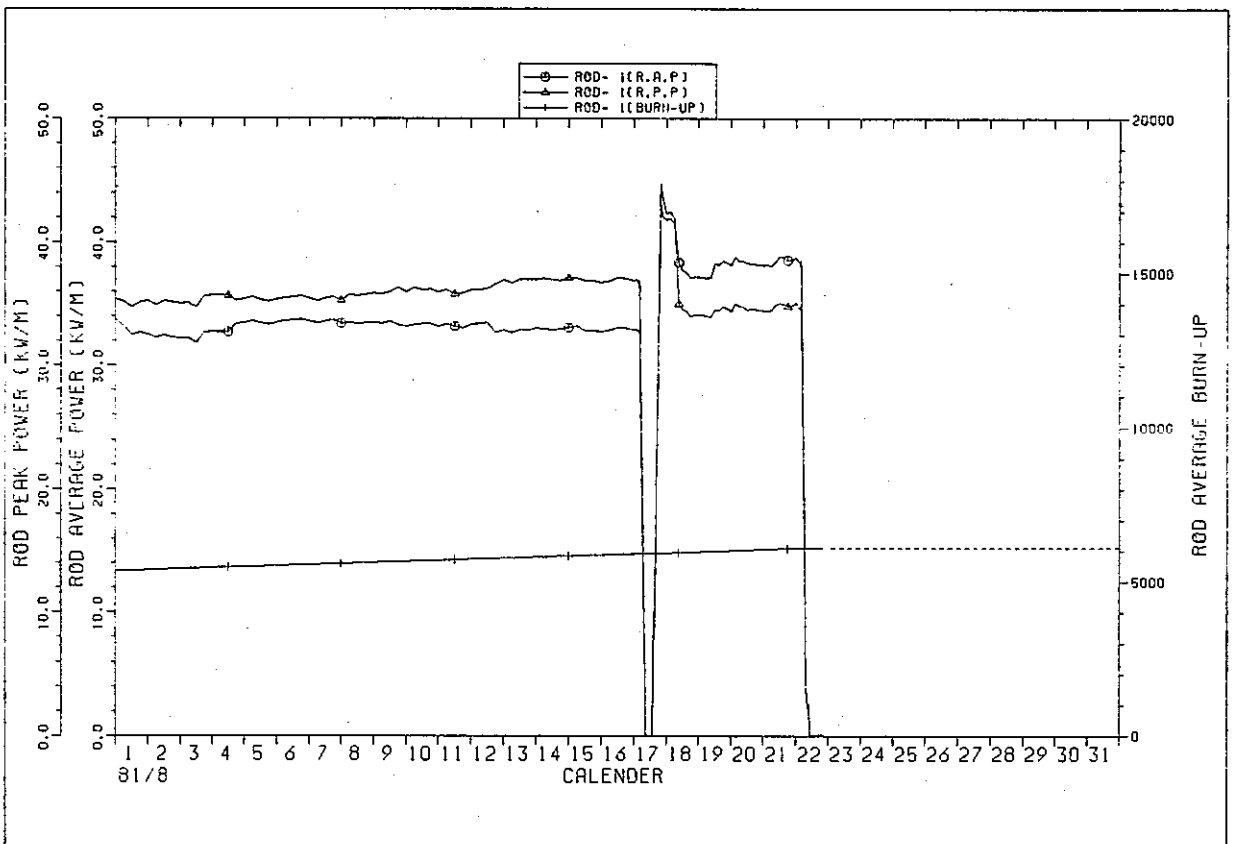

IFA529 ROD POWER HISTORY

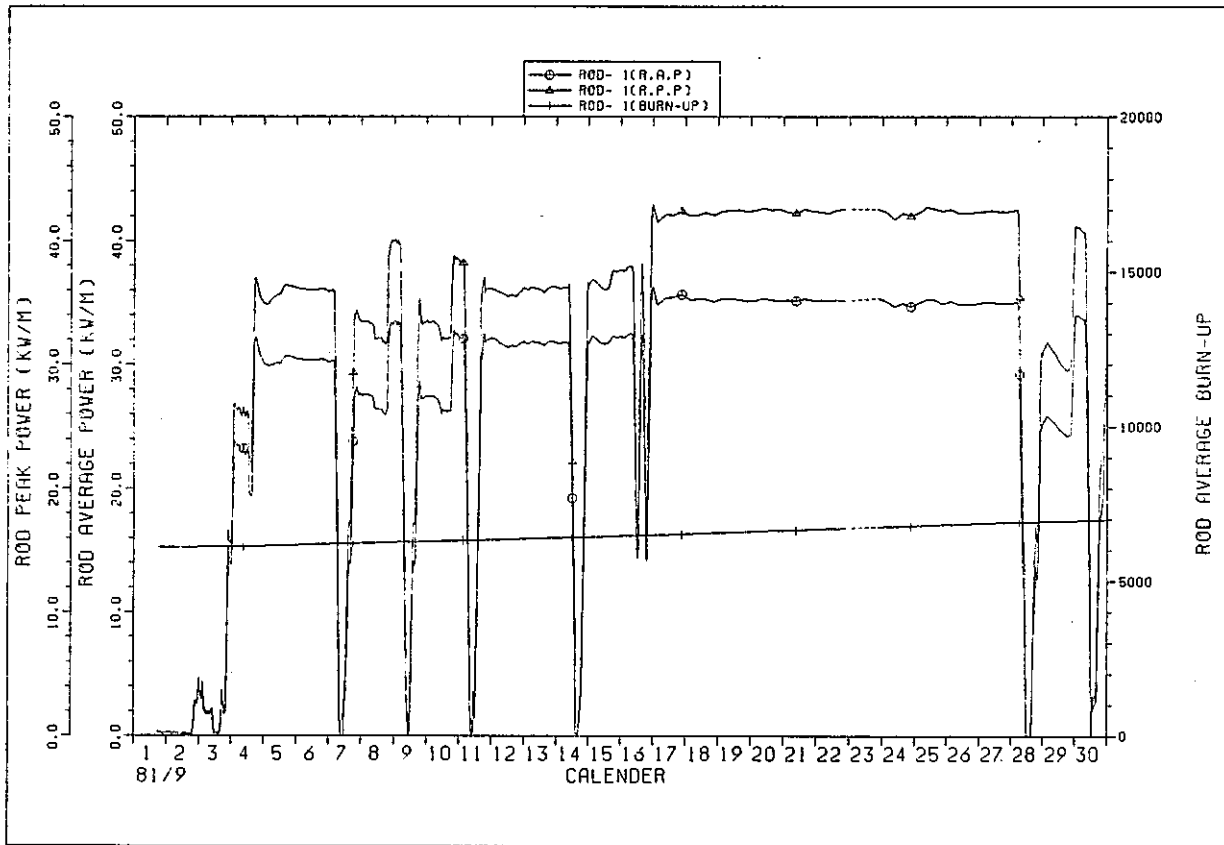

IFA529 ROD POWER HISTORY

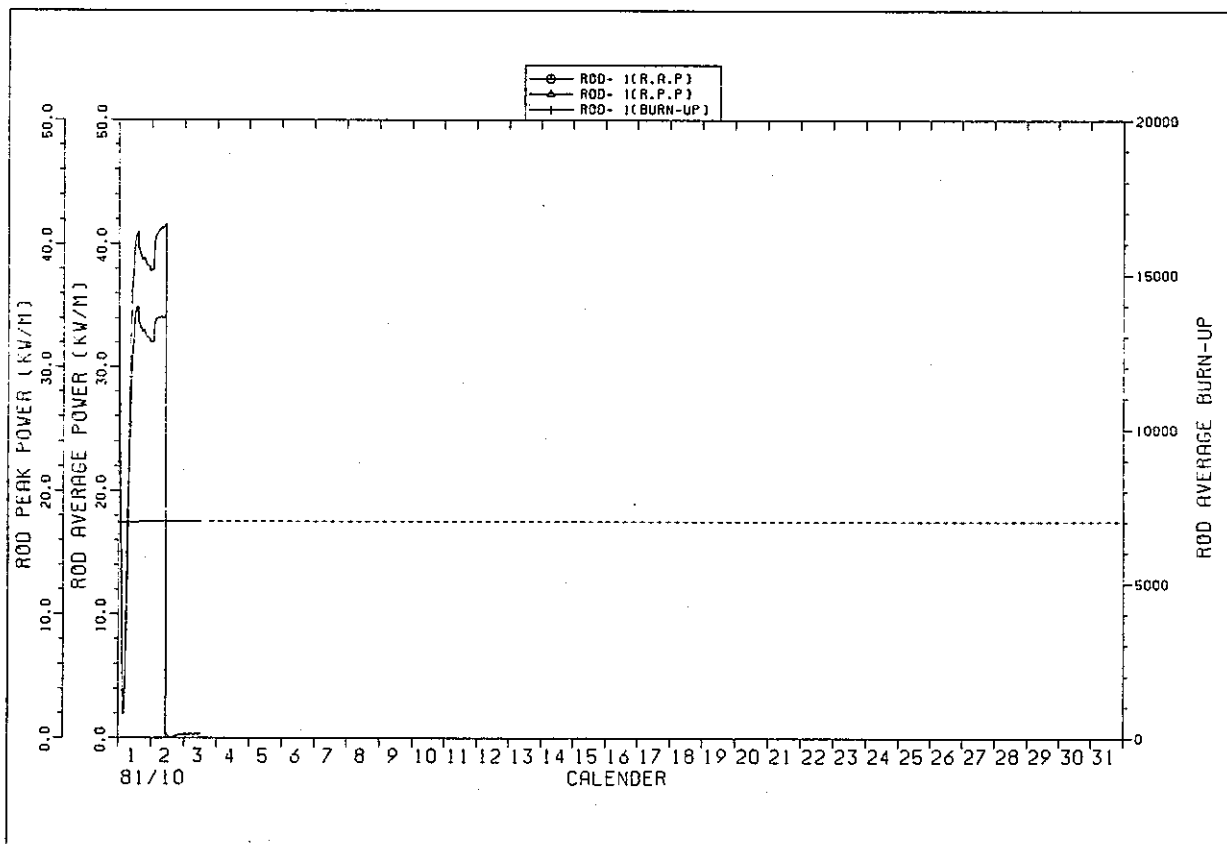

IFA529 ROD POWER HISTORY

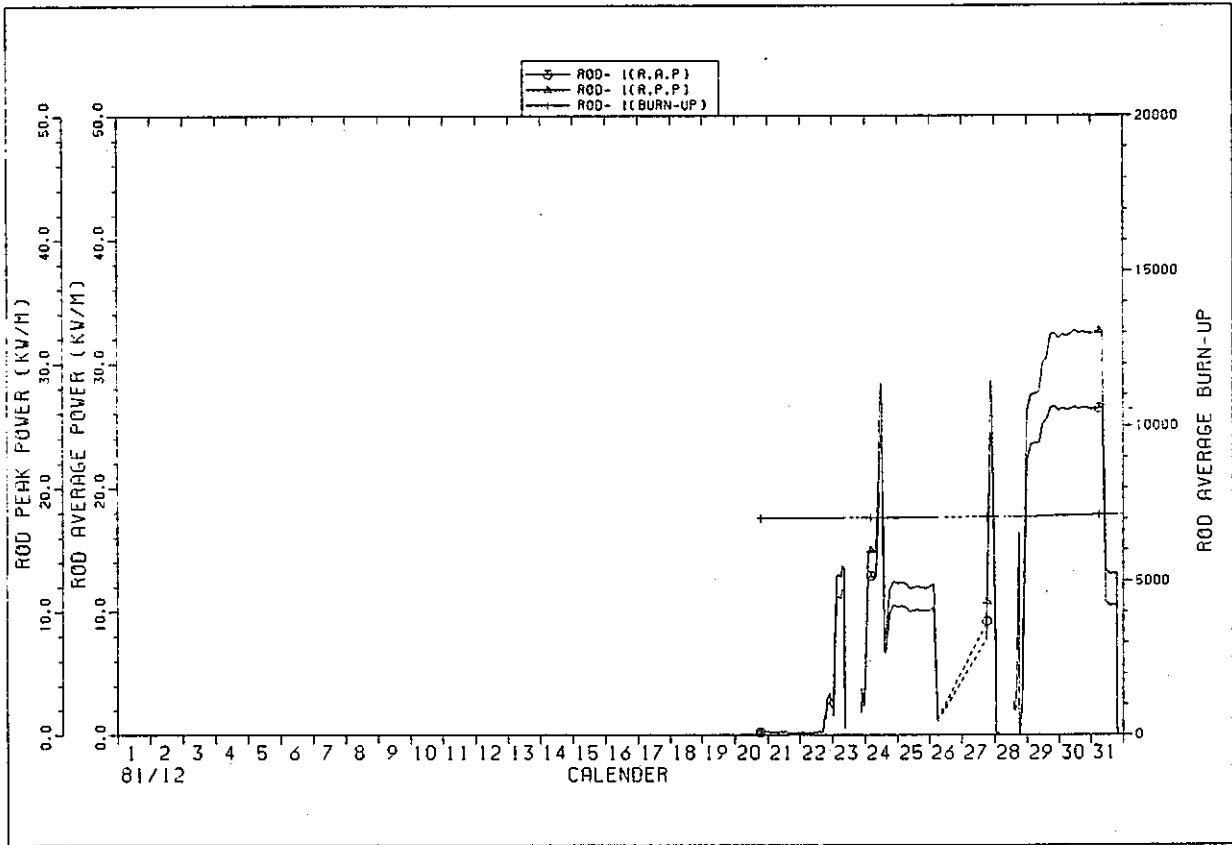

IFA529 ROD POWER HISTORY

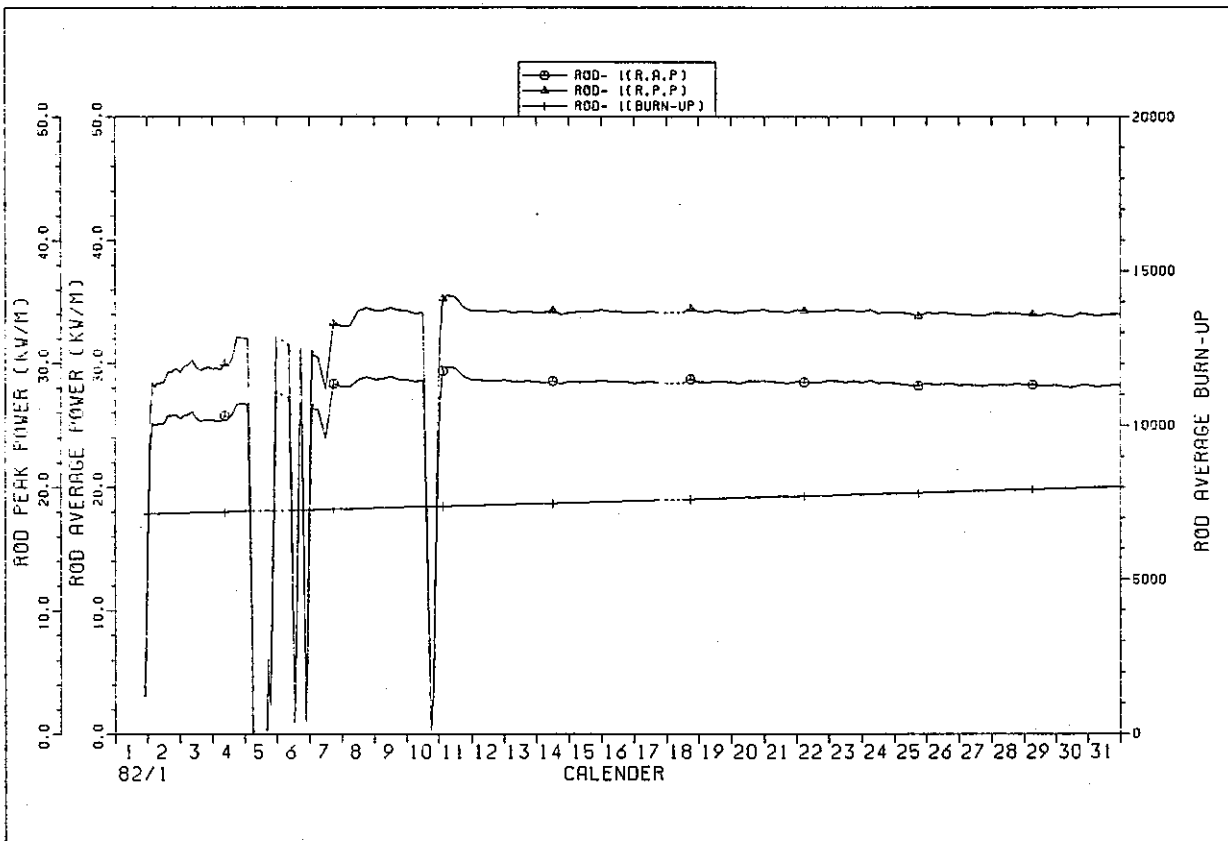

IFA529 ROD POWER HISTORY

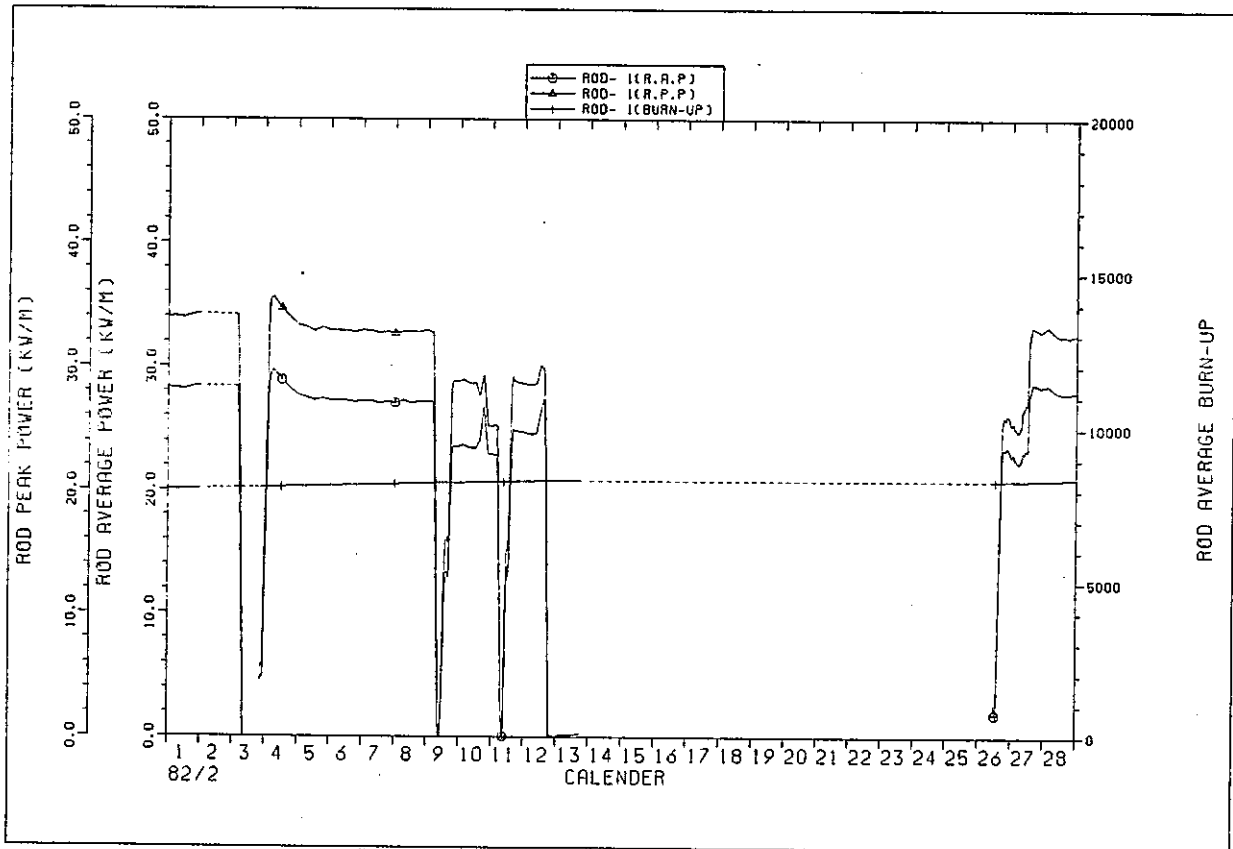

IFA529 ROD POWER HISTORY

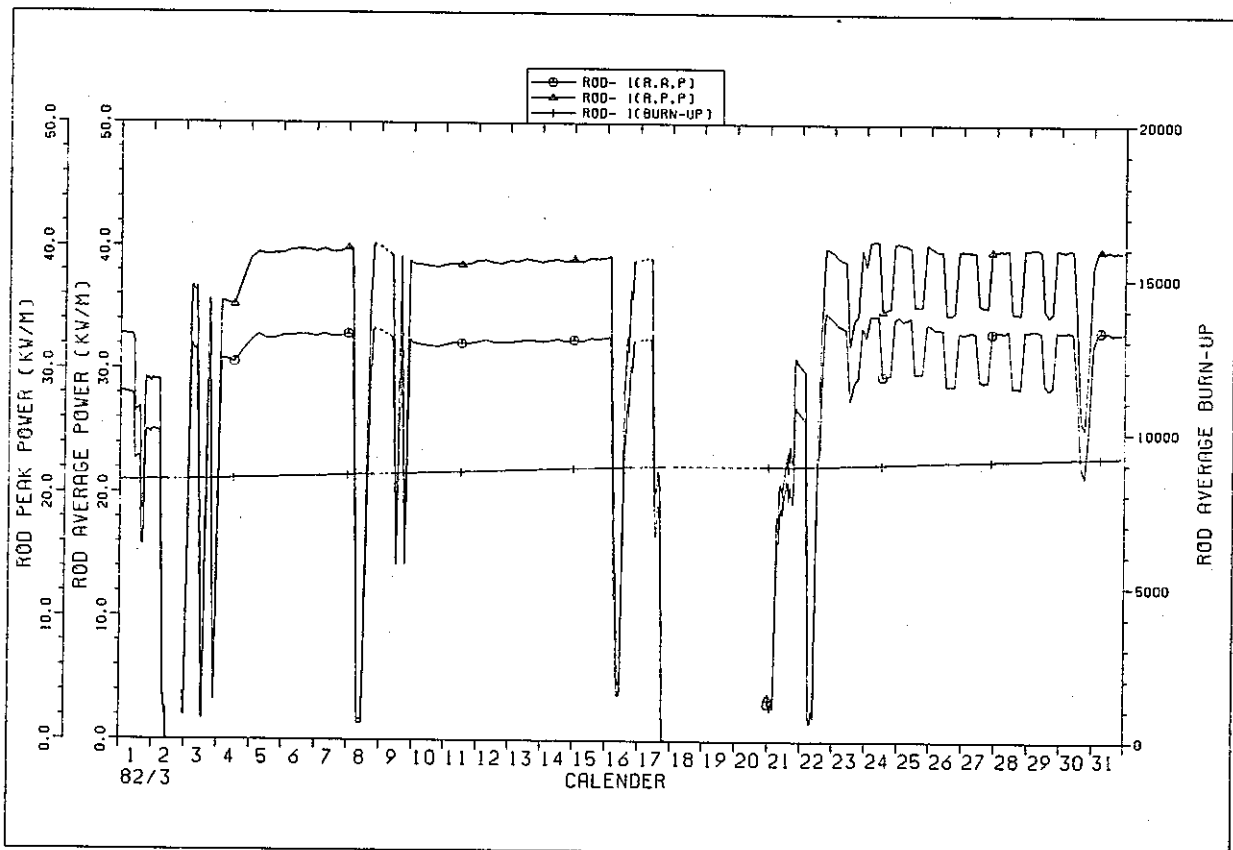

IFA529 ROD POWER HISTORY

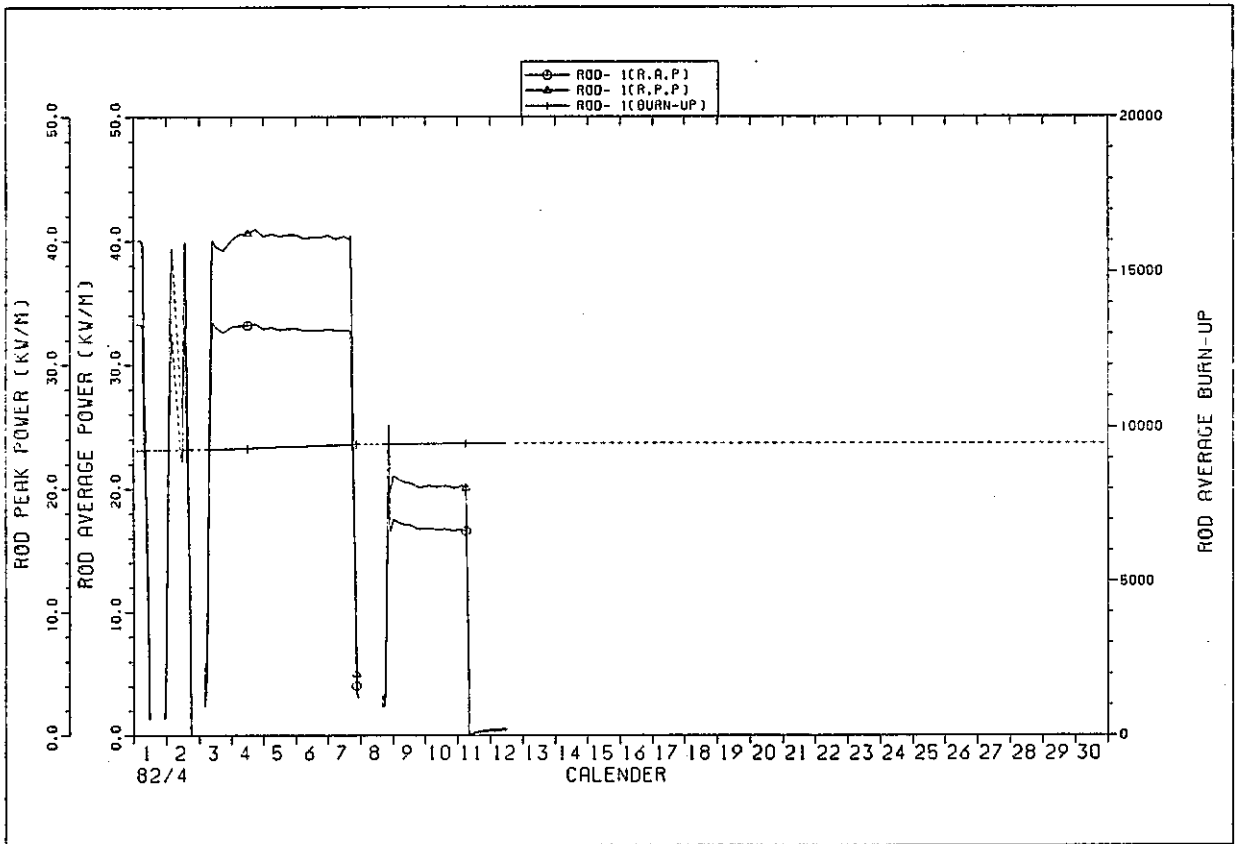

IFA529 ROD POWER HISTORY

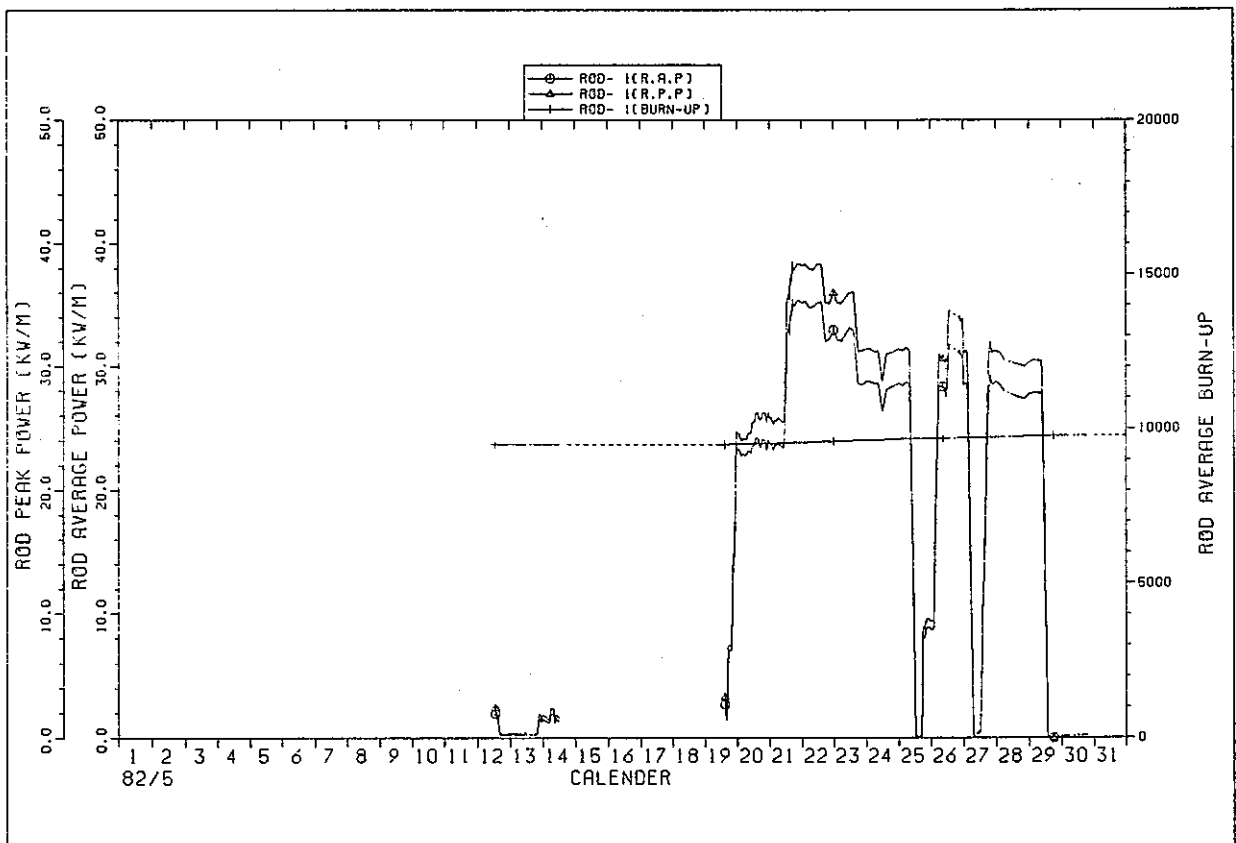

IFA529 ROD POWER HISTORY

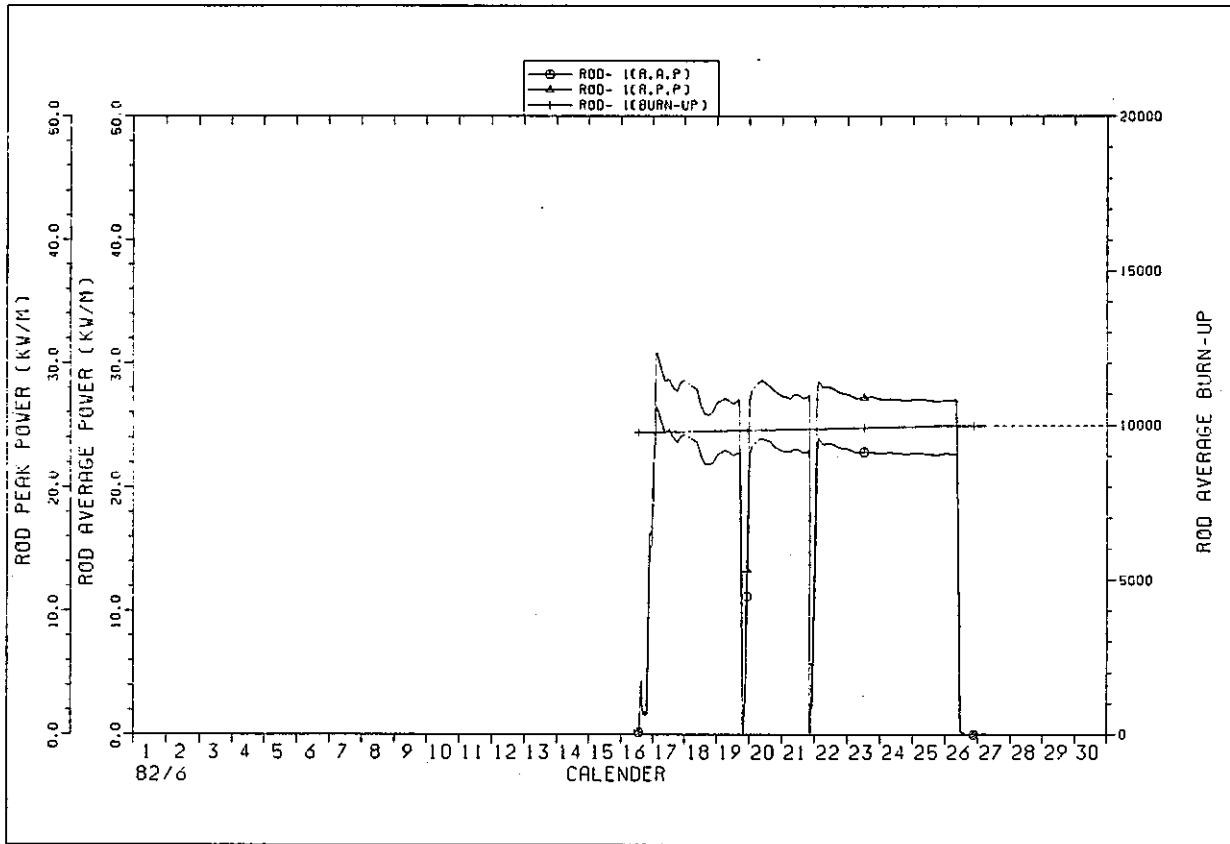

IFA529 ROD POWER HISTORY

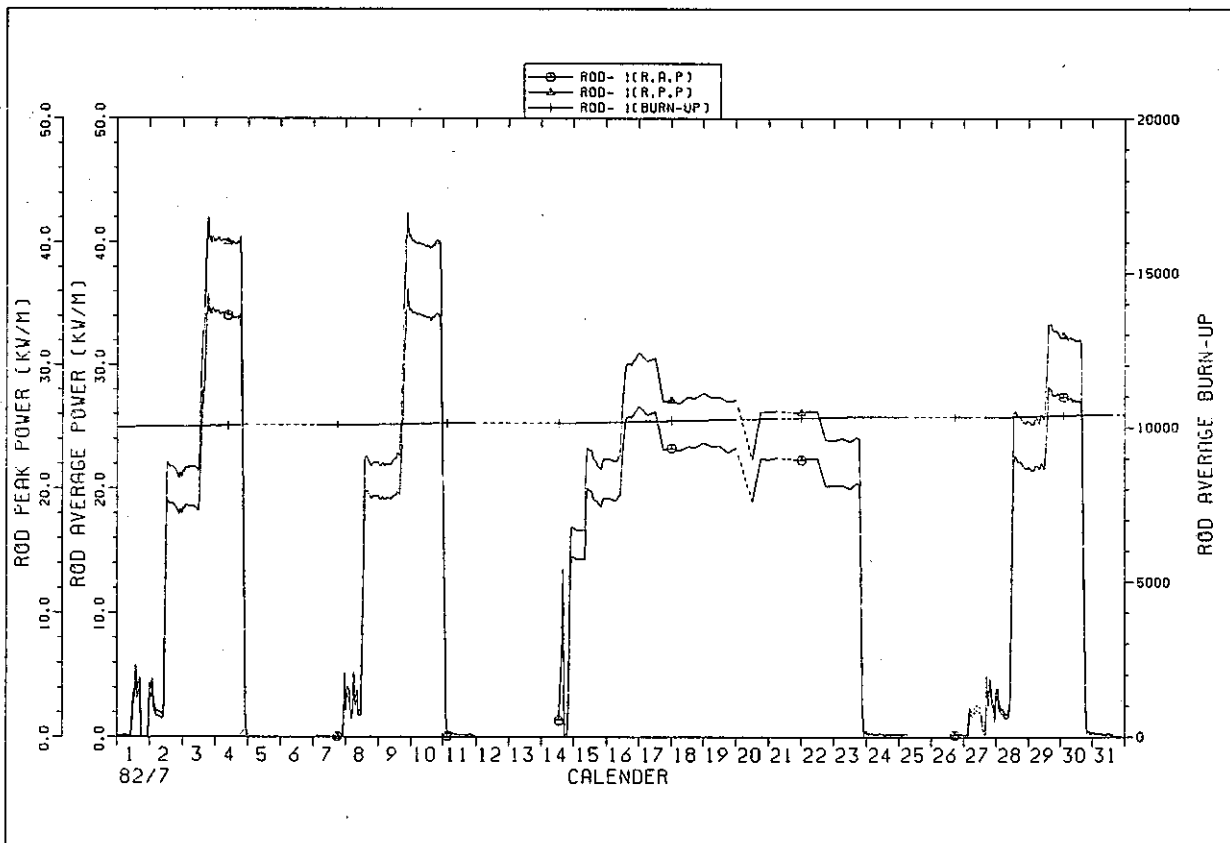

IFA529 ROD POWER HISTORY

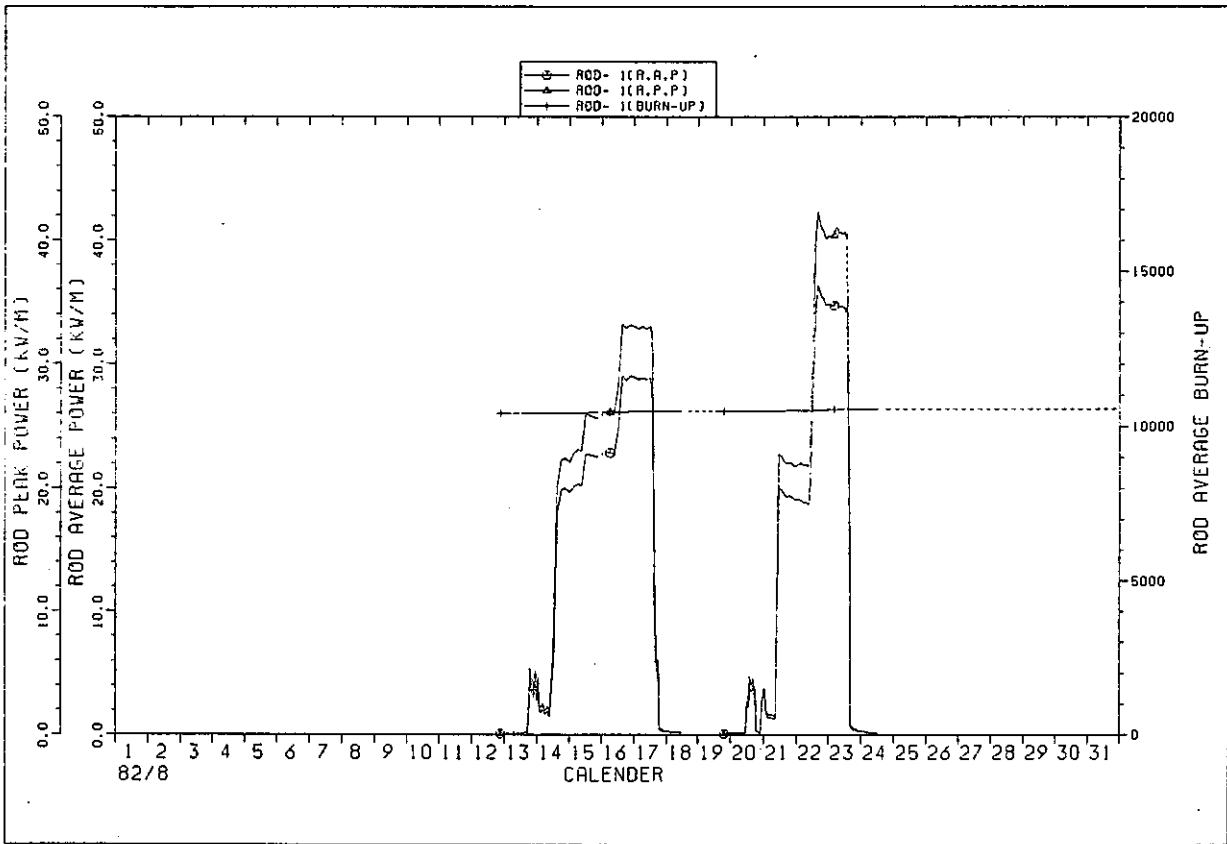

IFA529 ROD POWER HISTORY

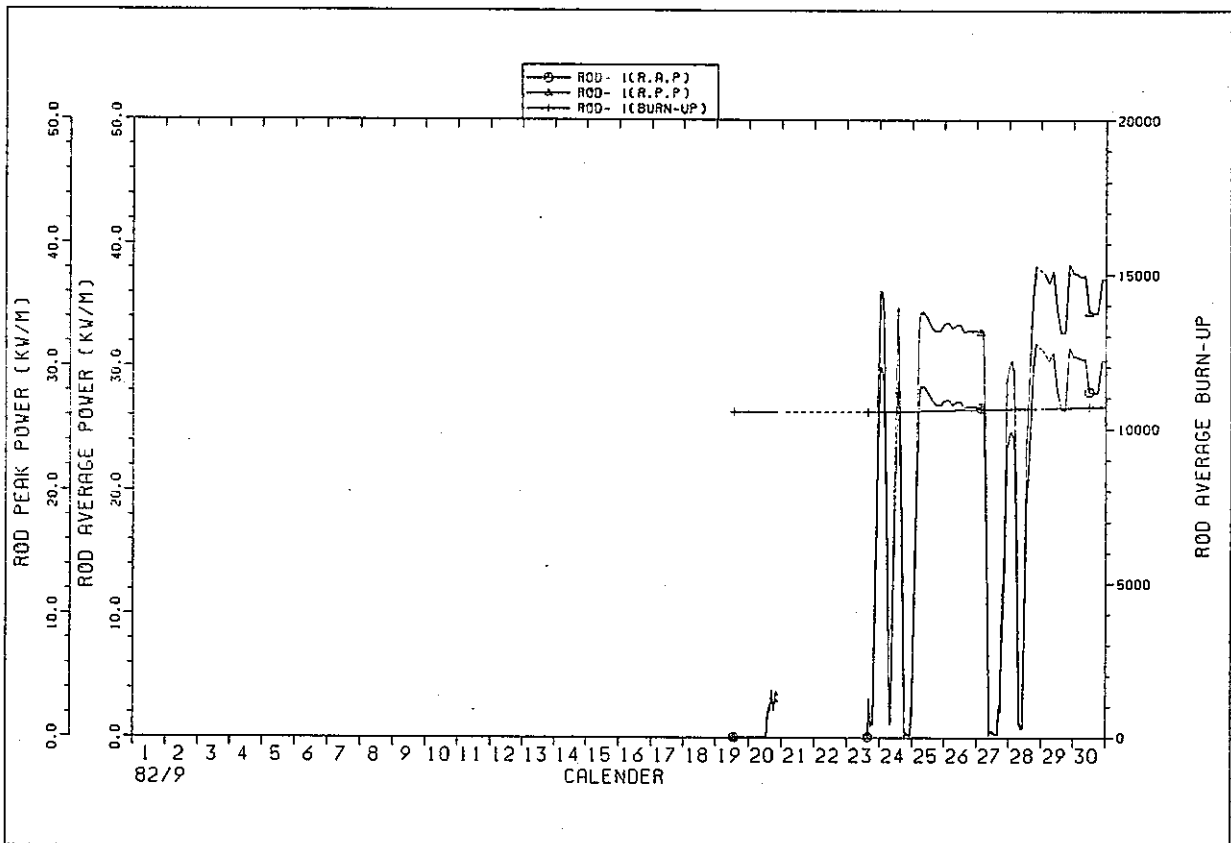

IFA529 ROD POWER HISTORY

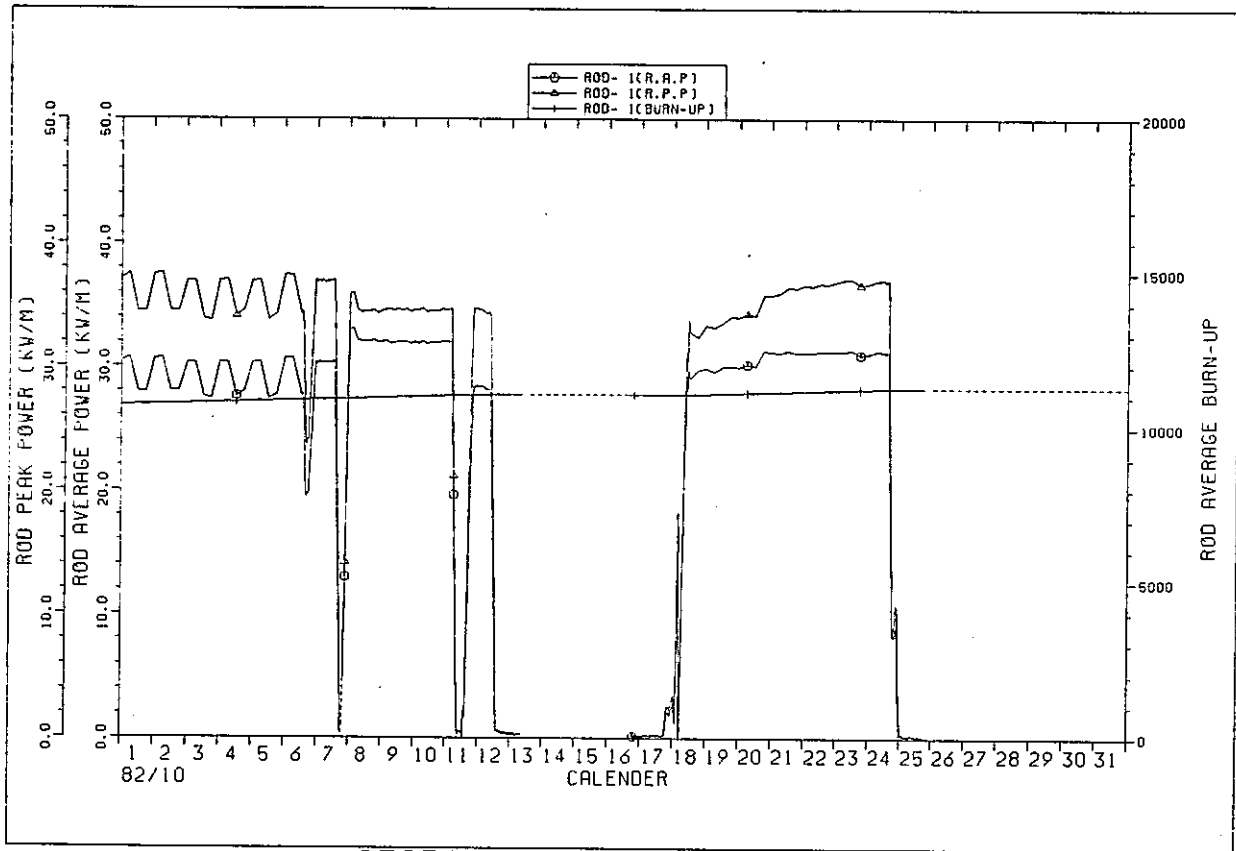

IFA529 ROD POWER HISTORY

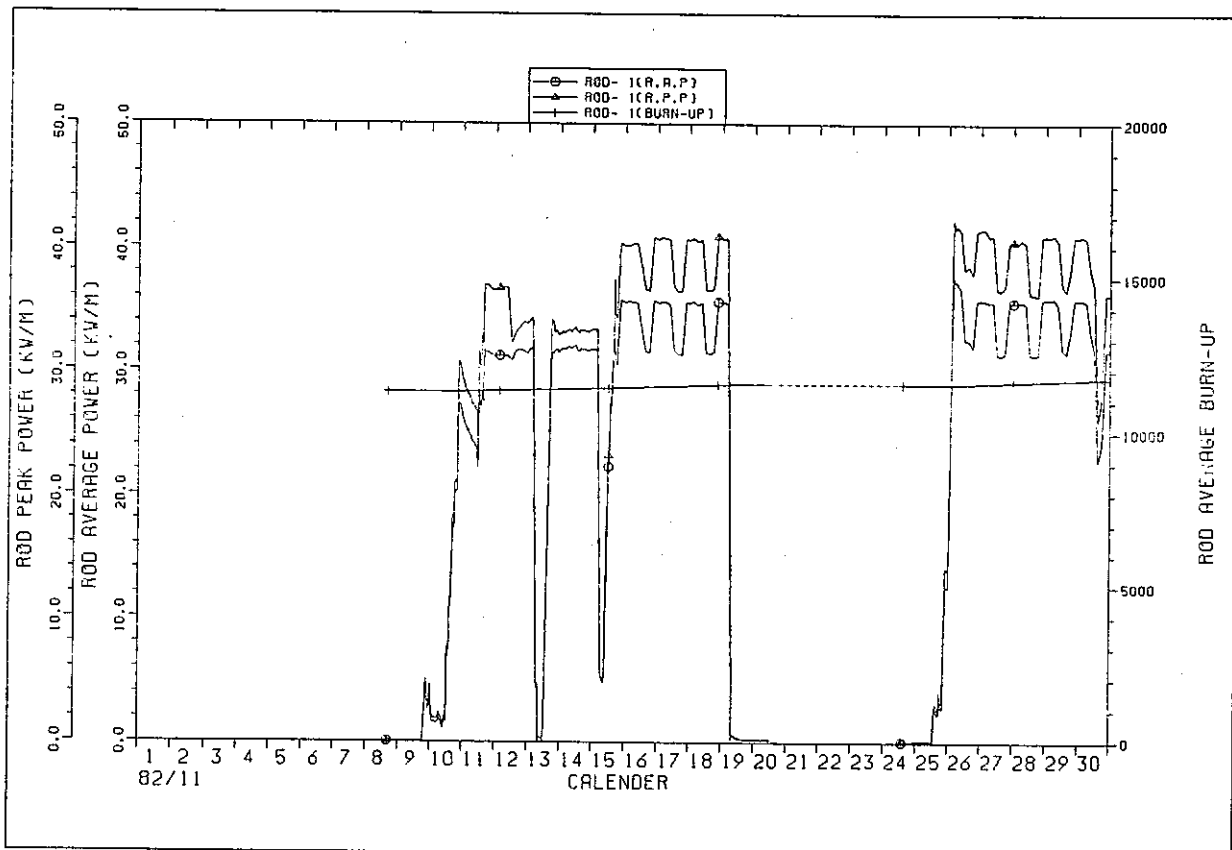

IFA529 ROD POWER HISTORY

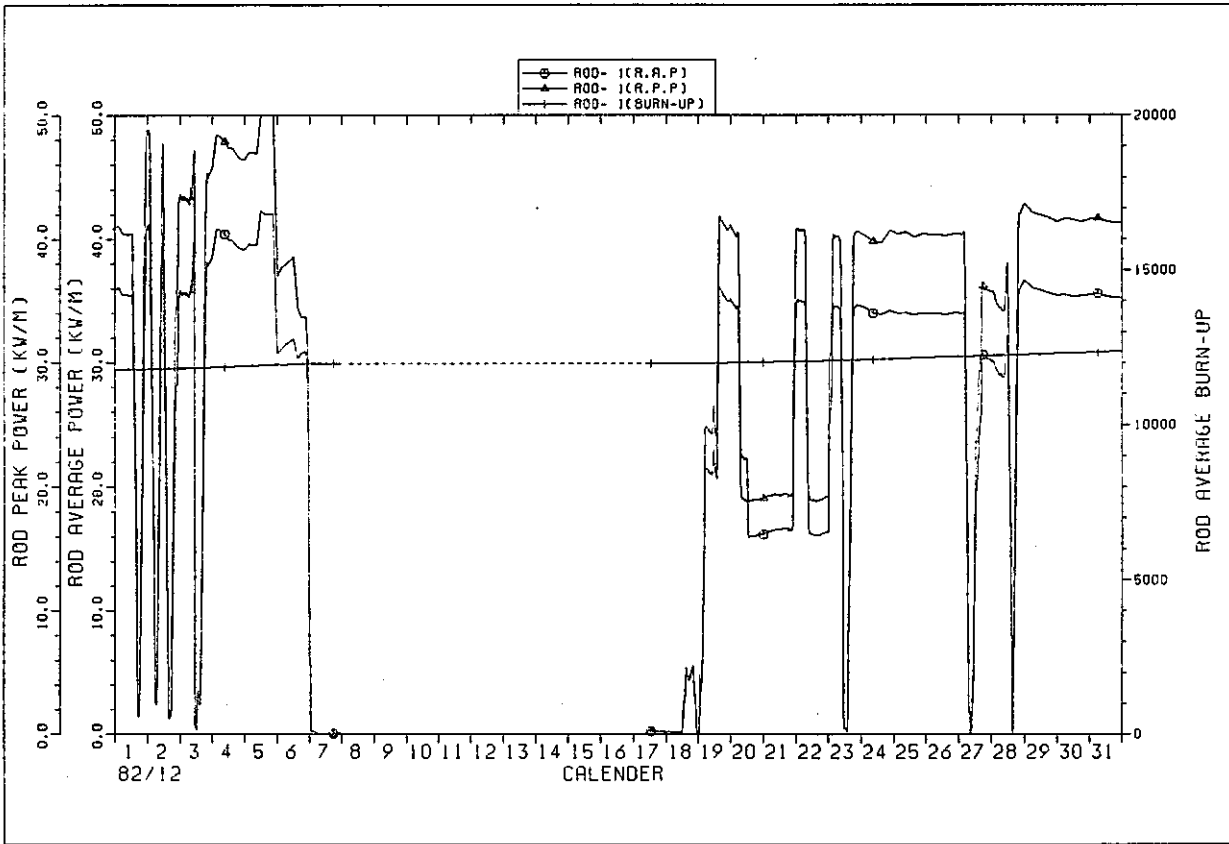

IFA529 ROD POWER HISTORY

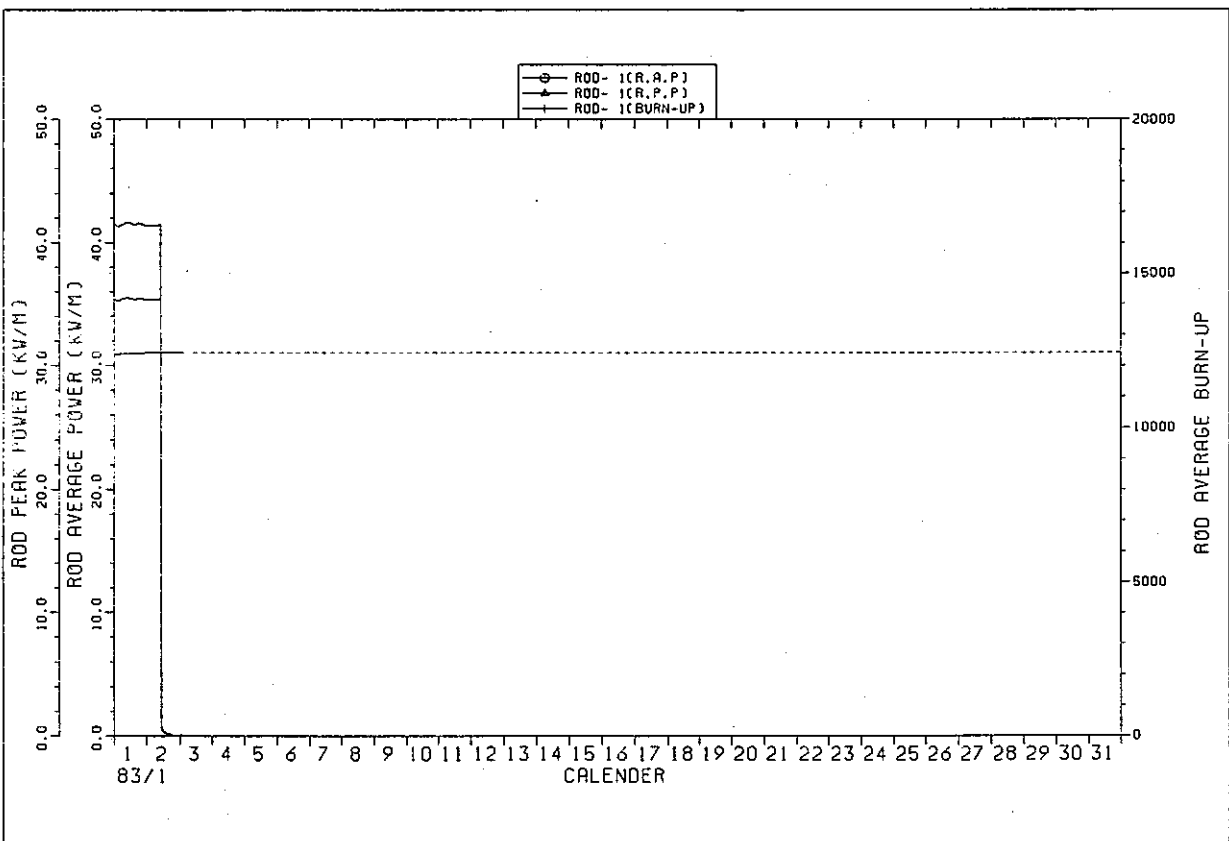

IFA529 ROD POWER HISTORY

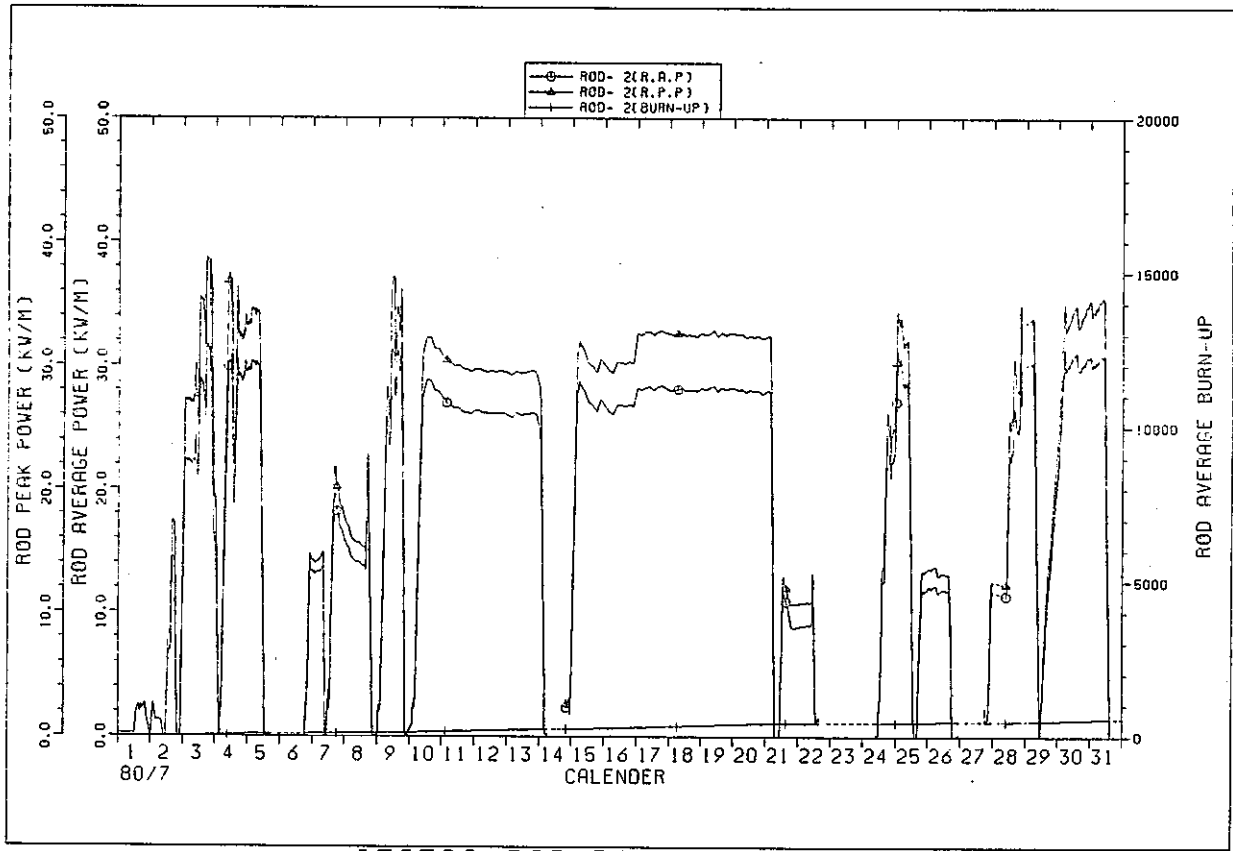

IFA529 ROD POWER HISTORY

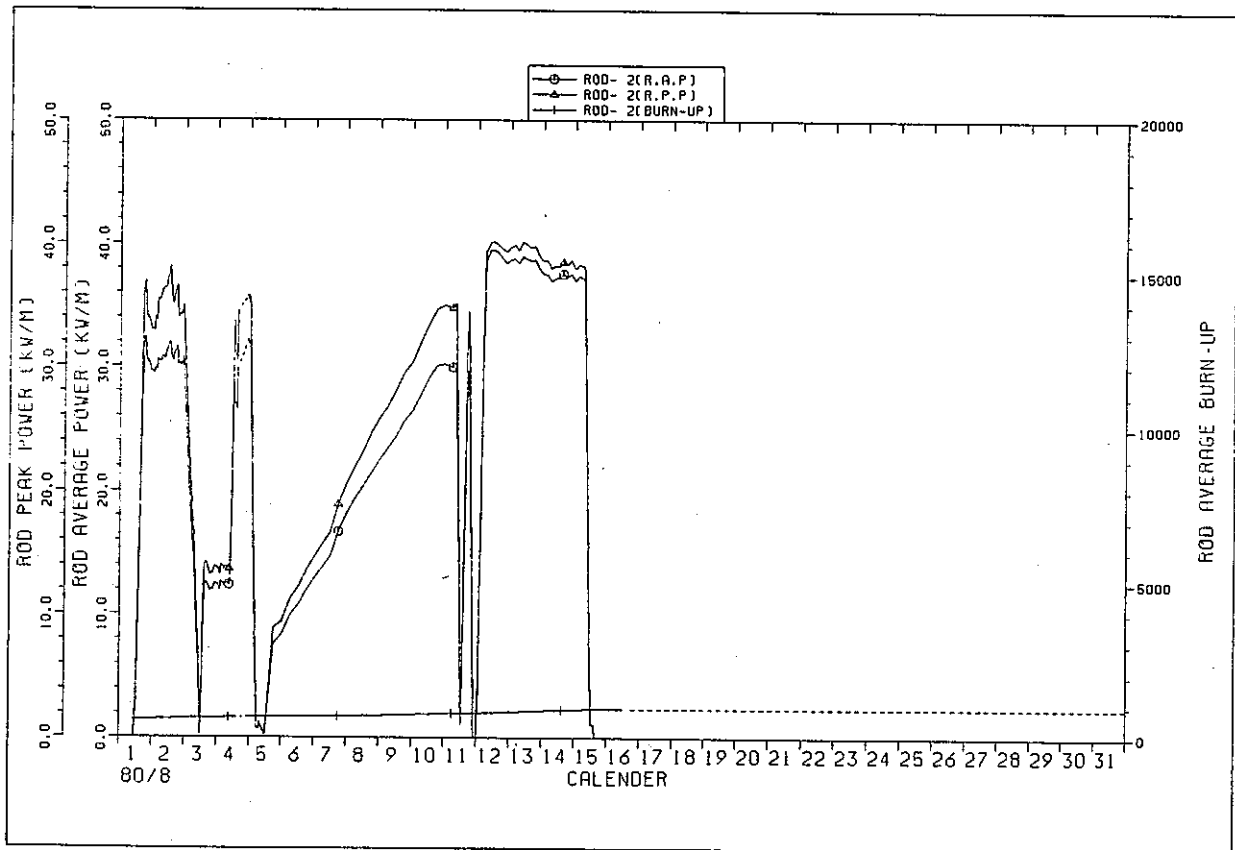

IFA529 ROD POWER HISTORY

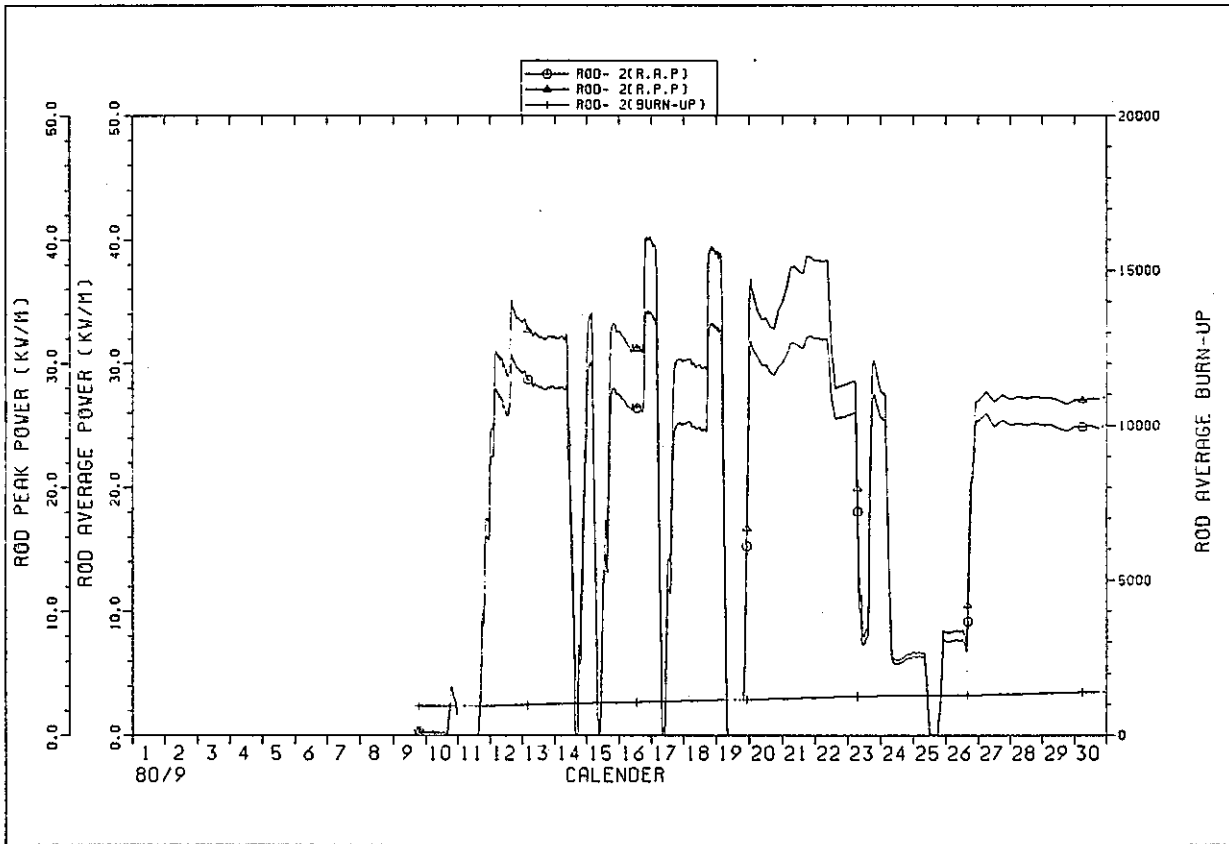

IFA529 ROD POWER HISTORY

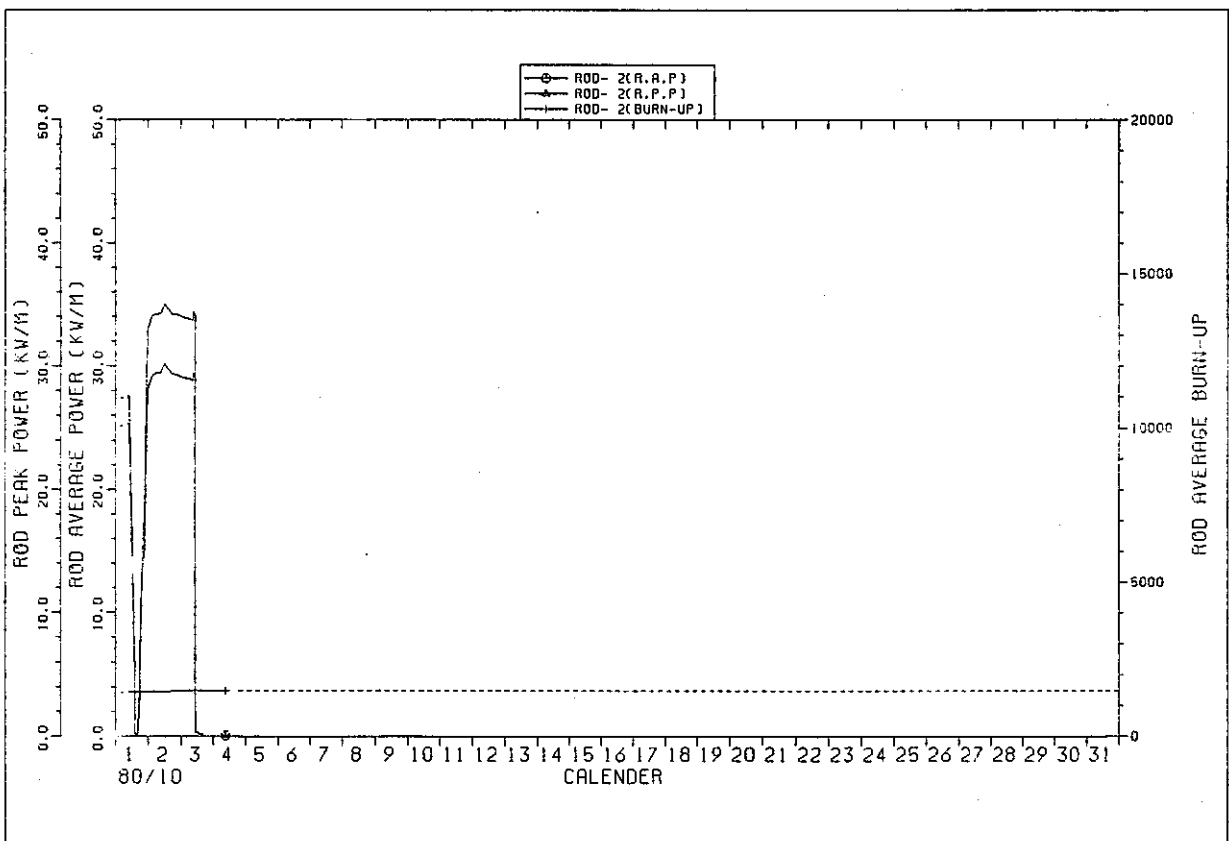

IFA529 ROD POWER HISTORY

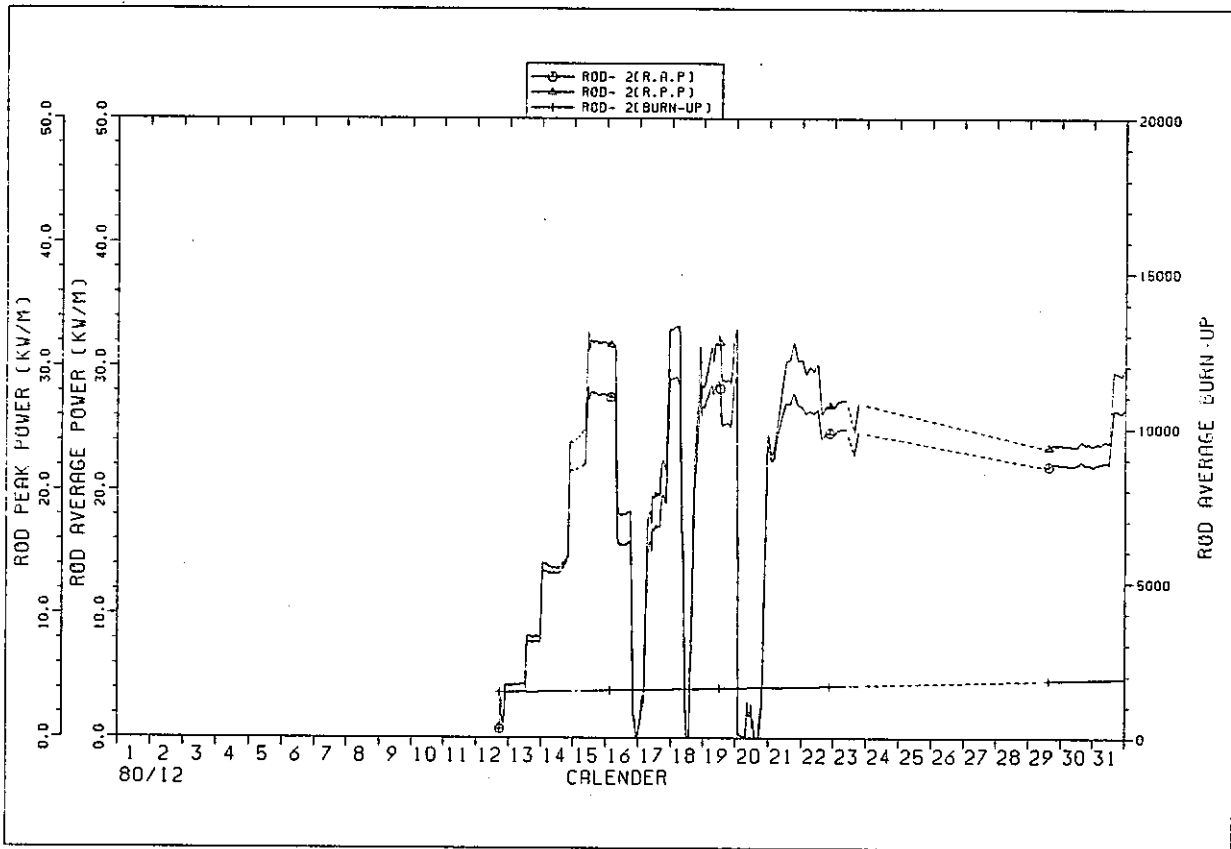

IFA529 ROD POWER HISTORY

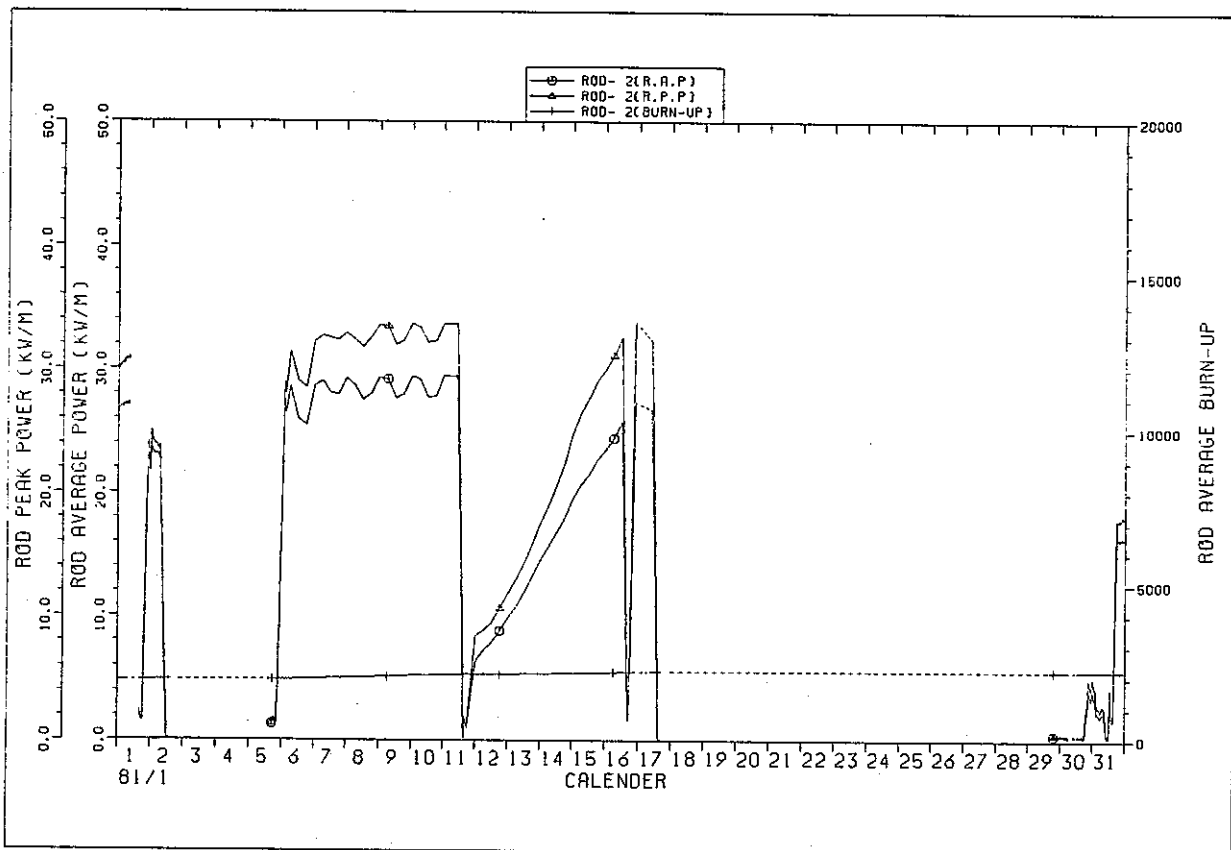

IFA529 ROD POWER HISTORY

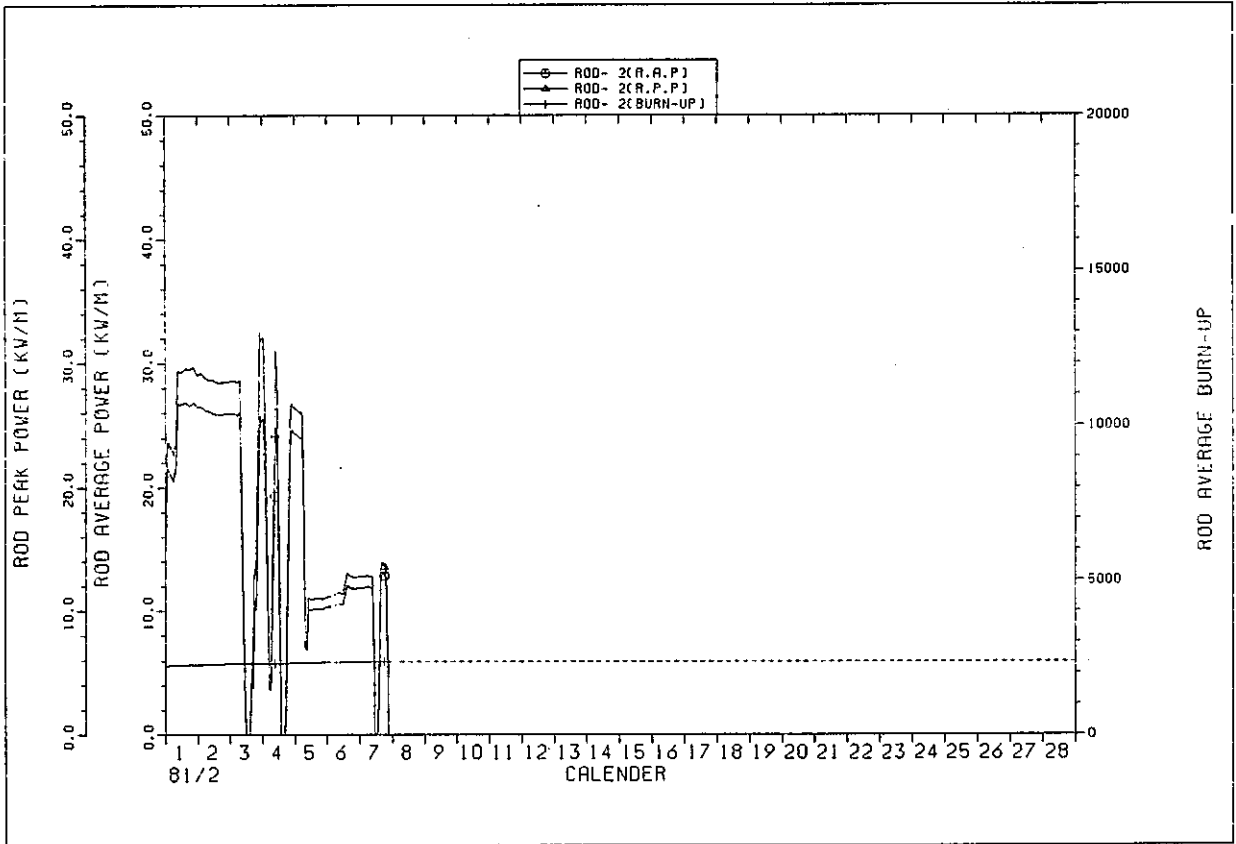

IFA529 ROD POWER HISTORY

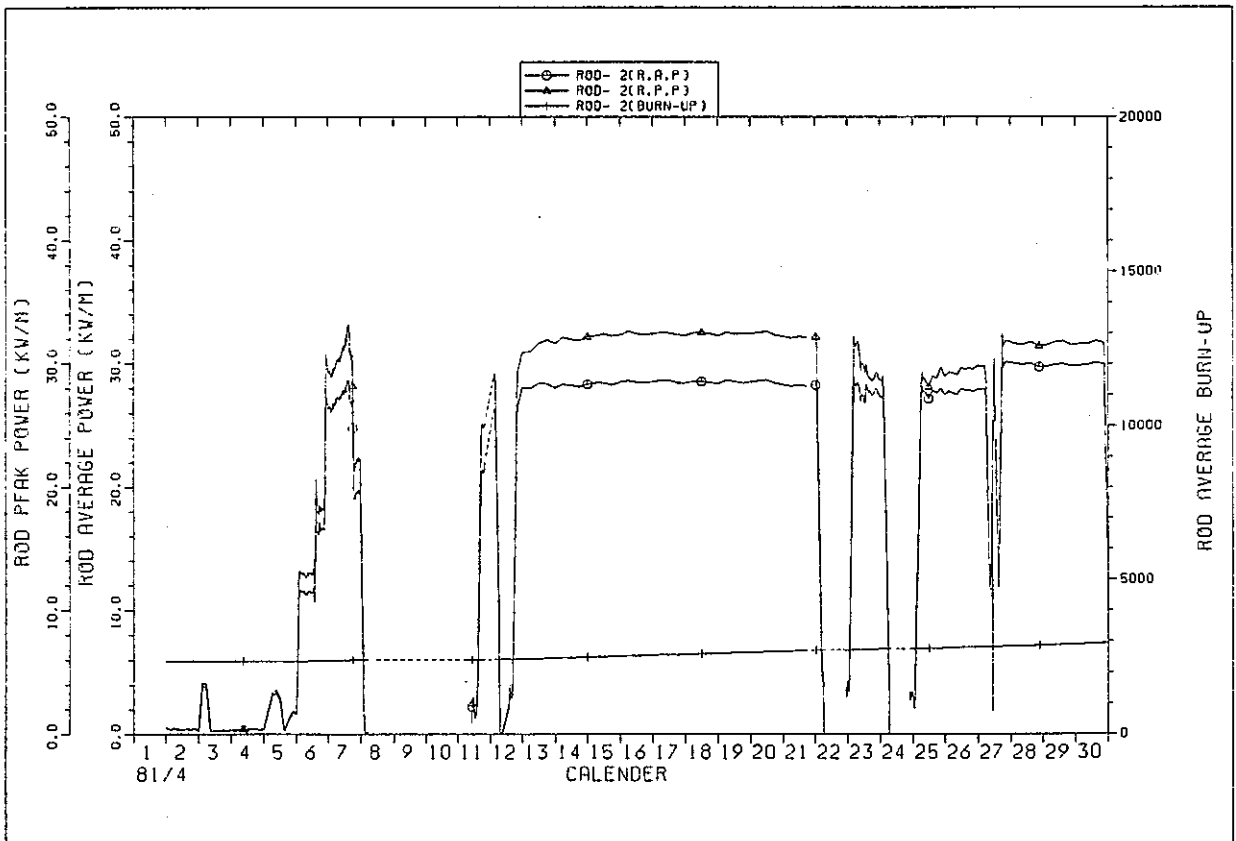

IFA529 ROD POWER HISTORY

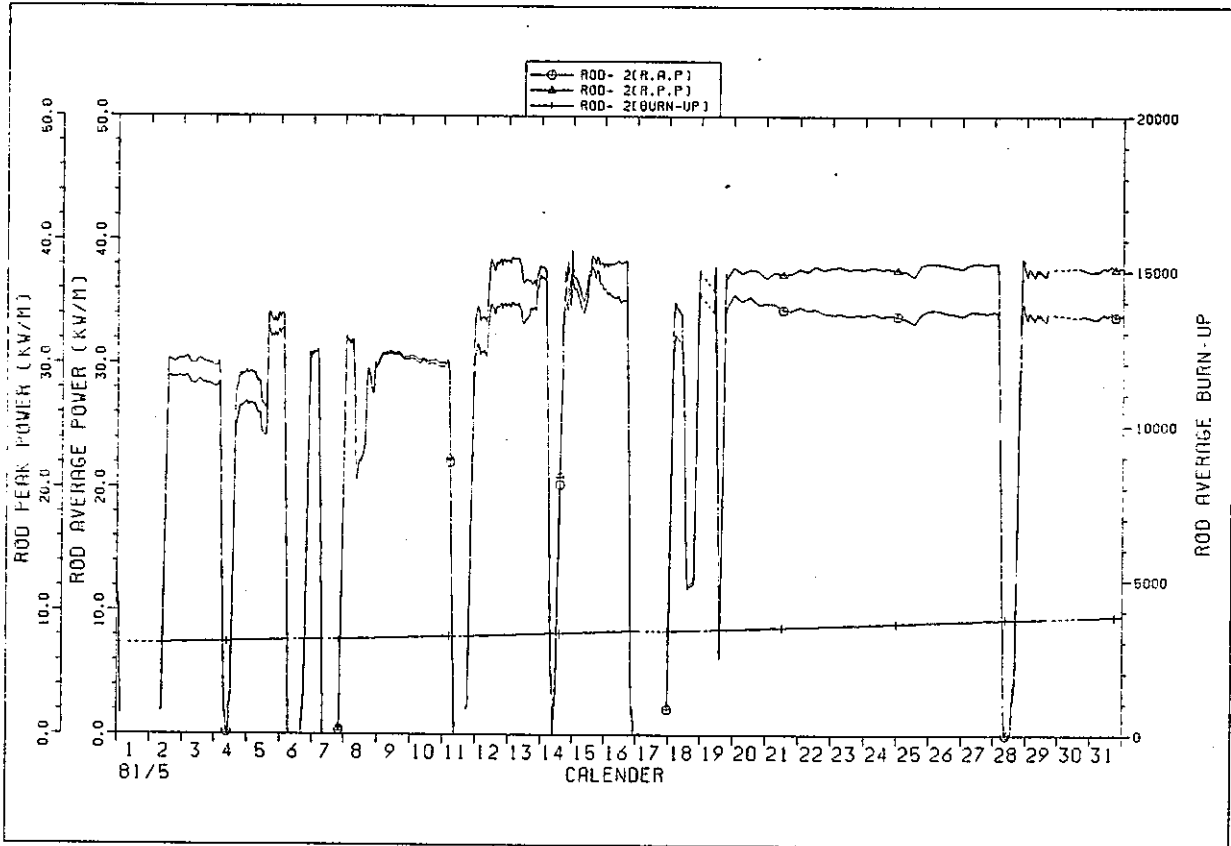

IFA529 ROD POWER HISTORY

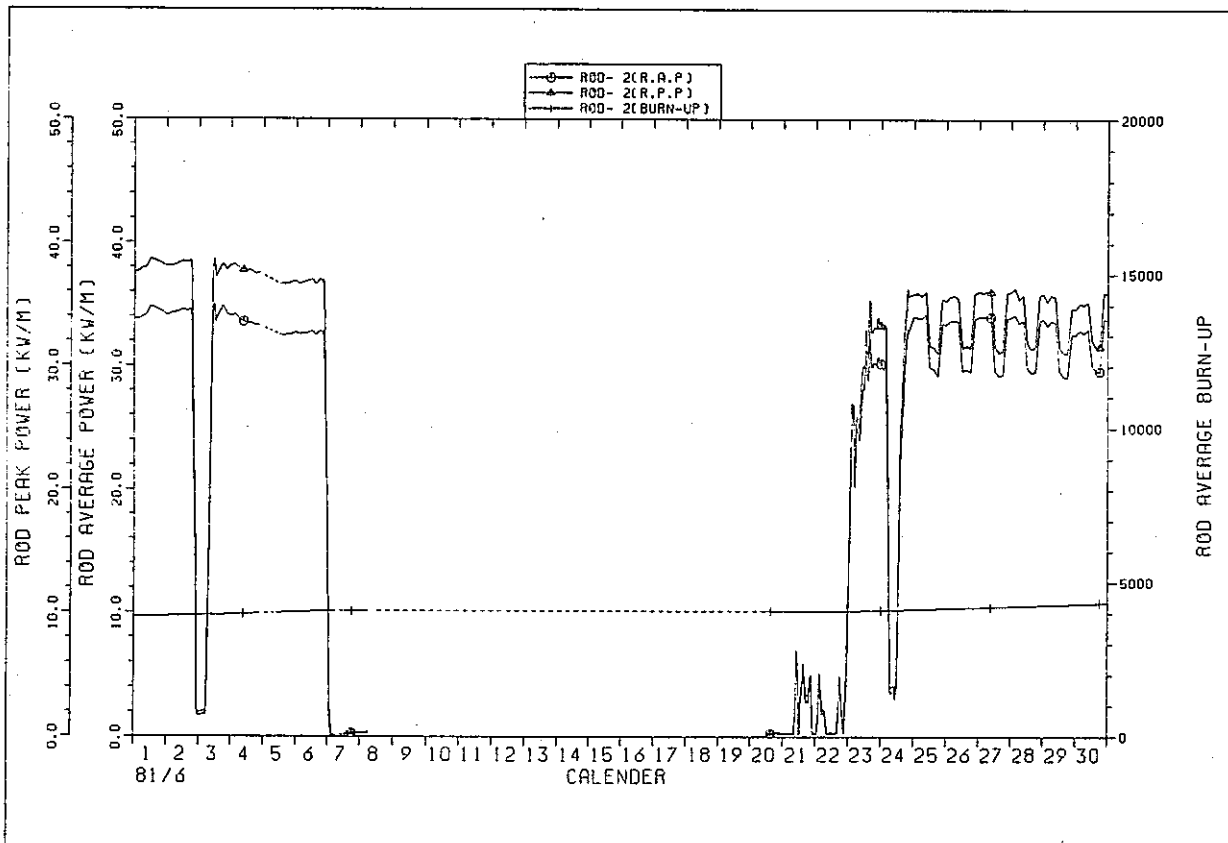

IFA529 ROD POWER HISTORY

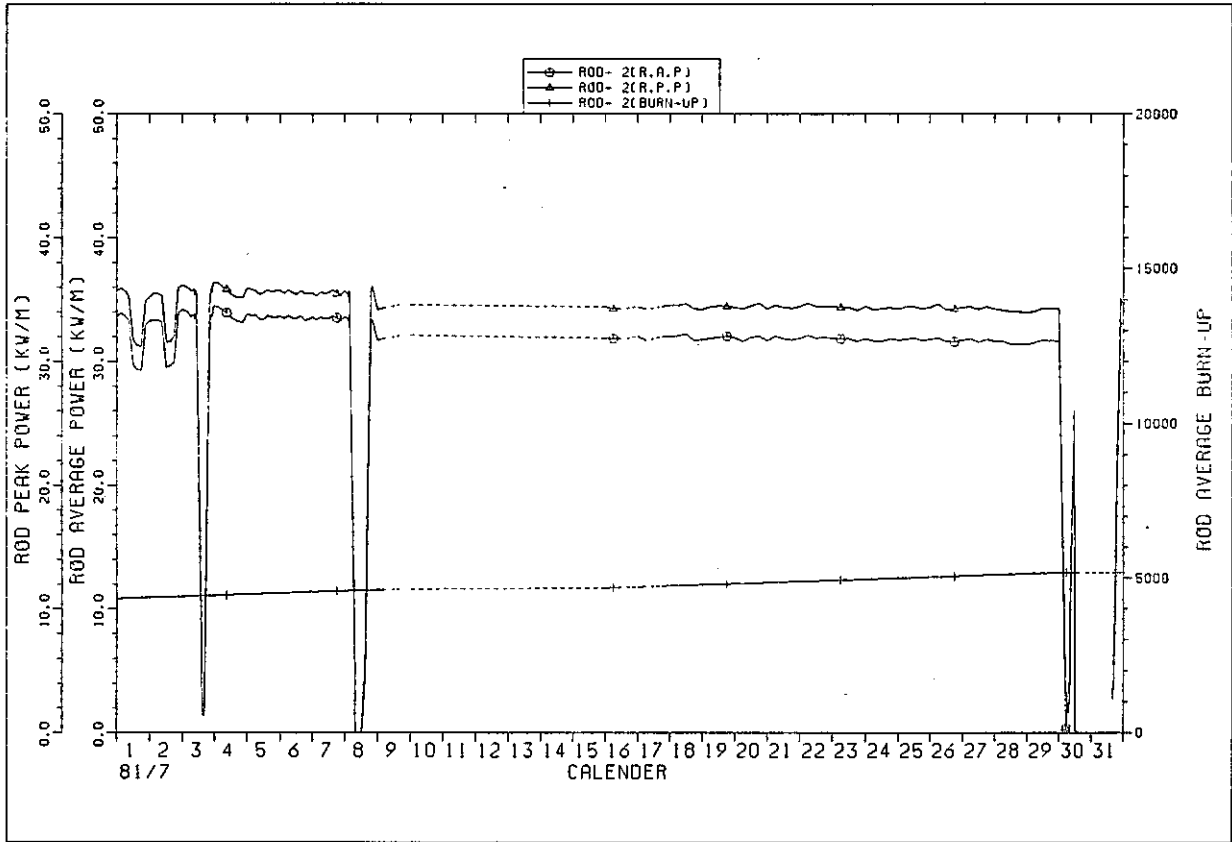

IFA529 ROD POWER HISTORY

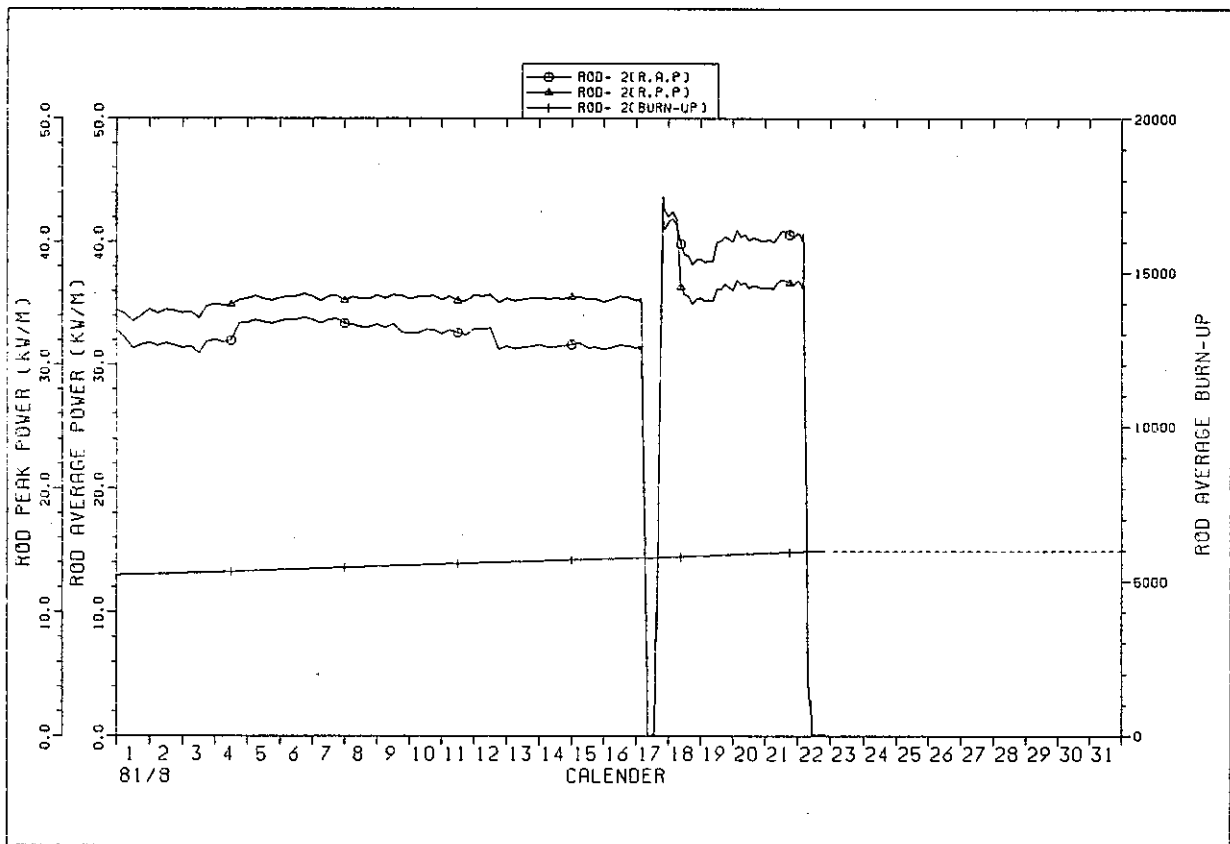

IFA529 ROD POWER HISTORY

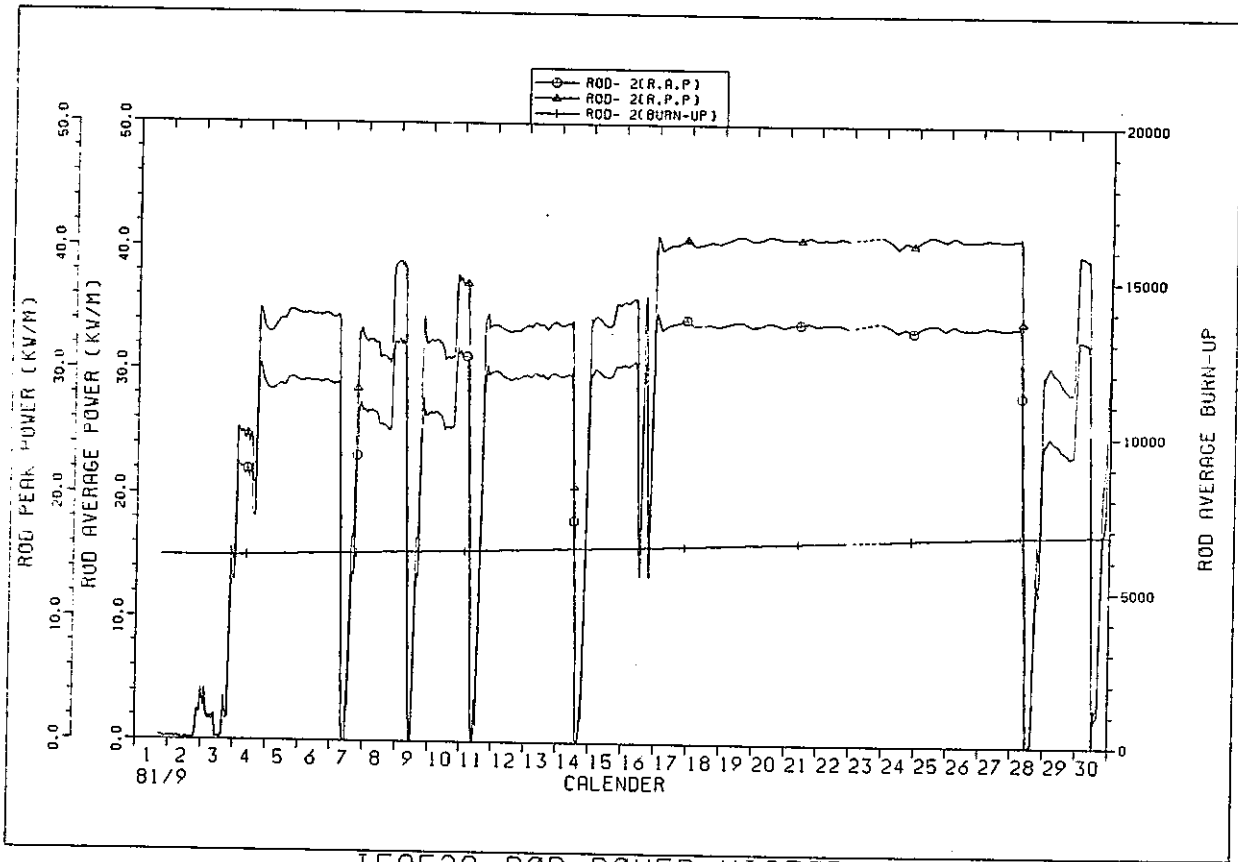

IFA529 ROD POWER HISTORY

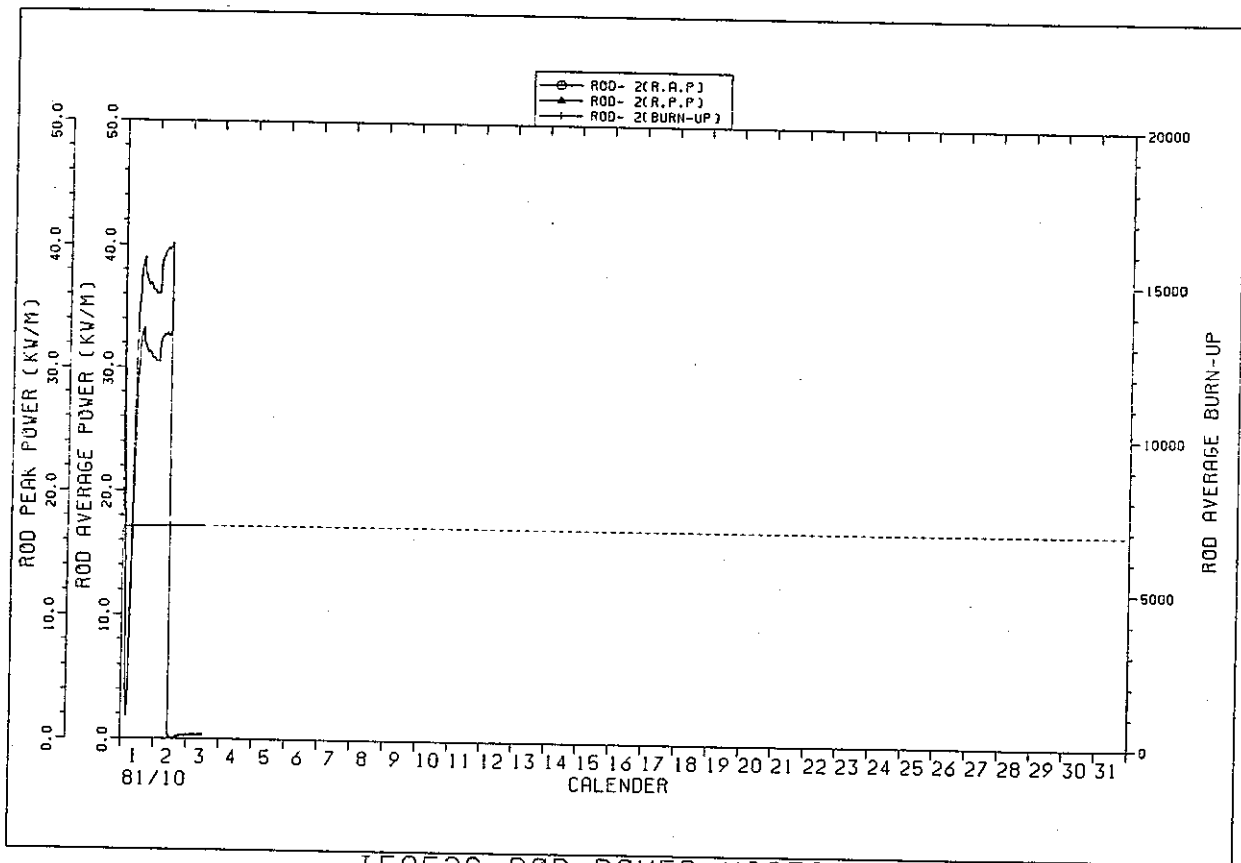

IFA529 ROD POWER HISTORY

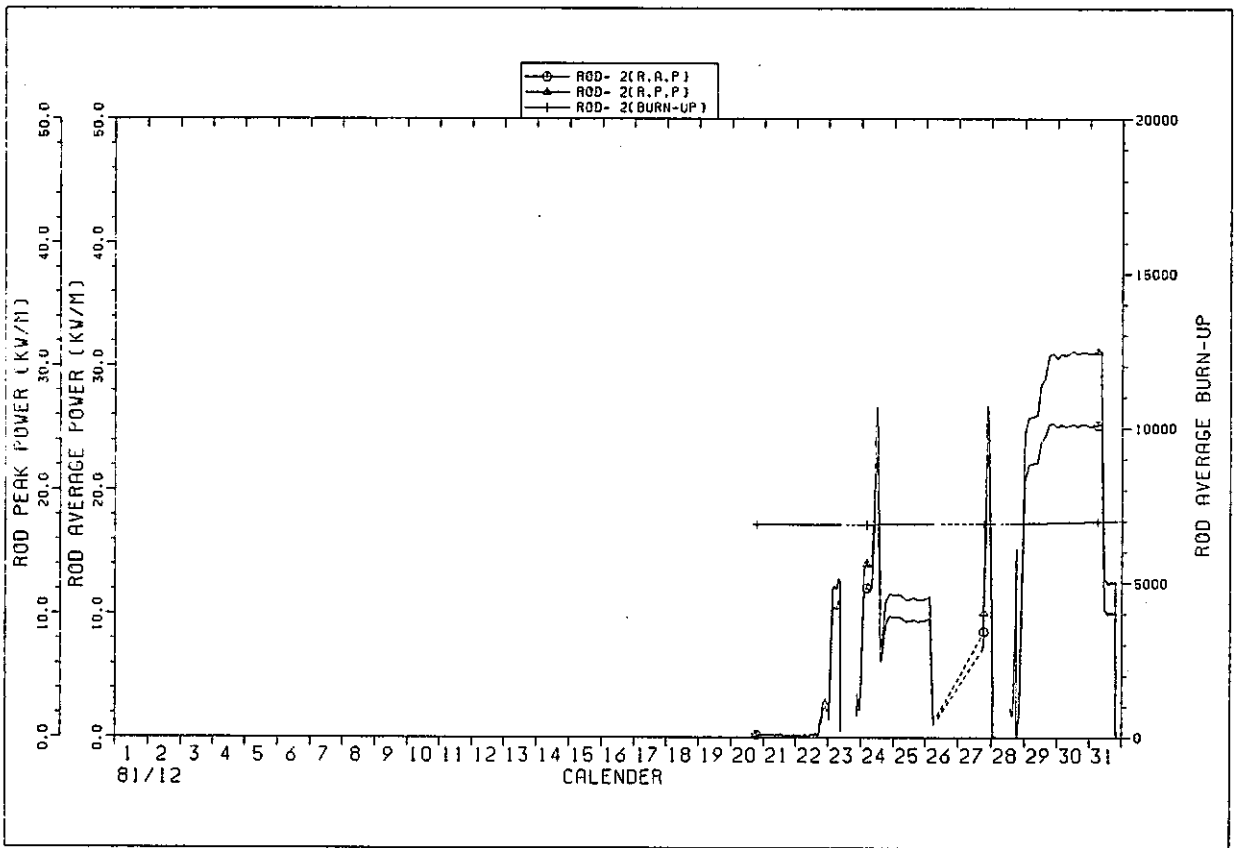

IFA529 ROD POWER HISTORY

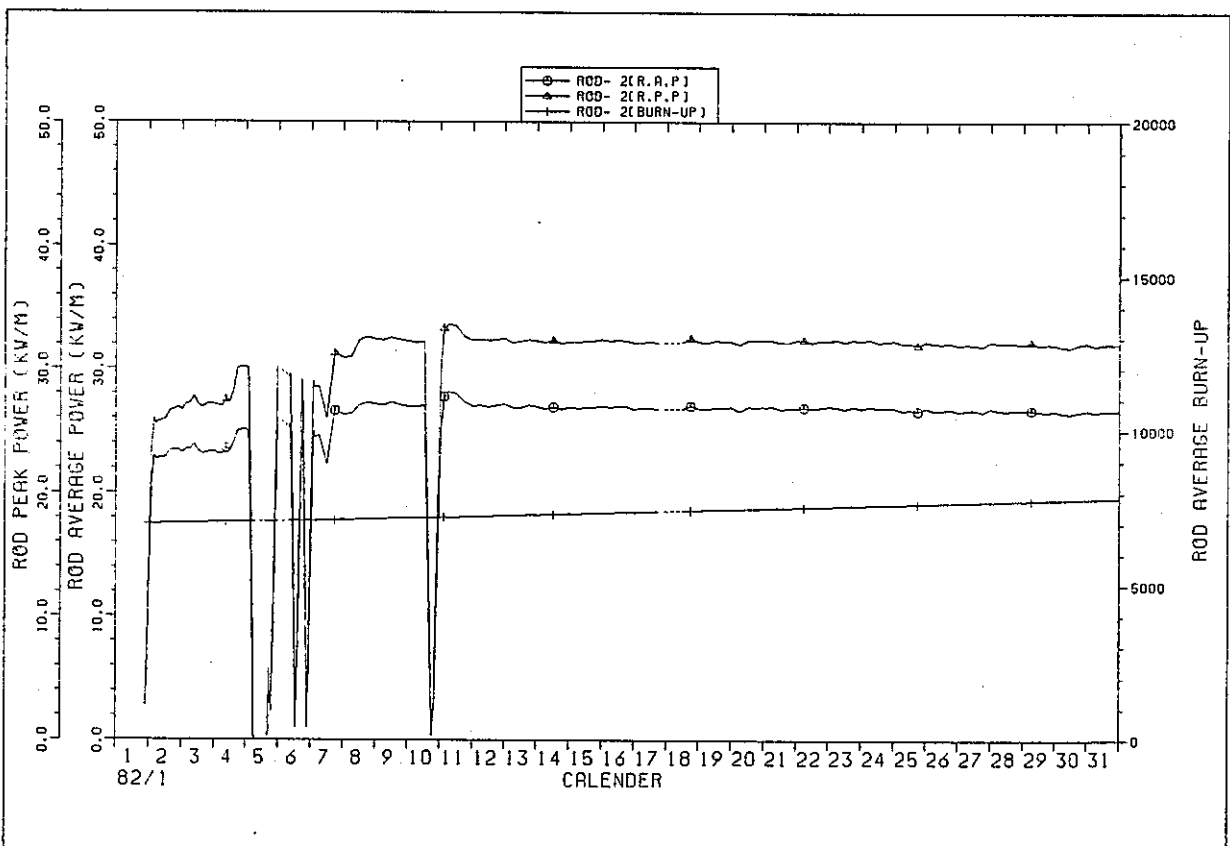

IFA529 ROD POWER HISTORY

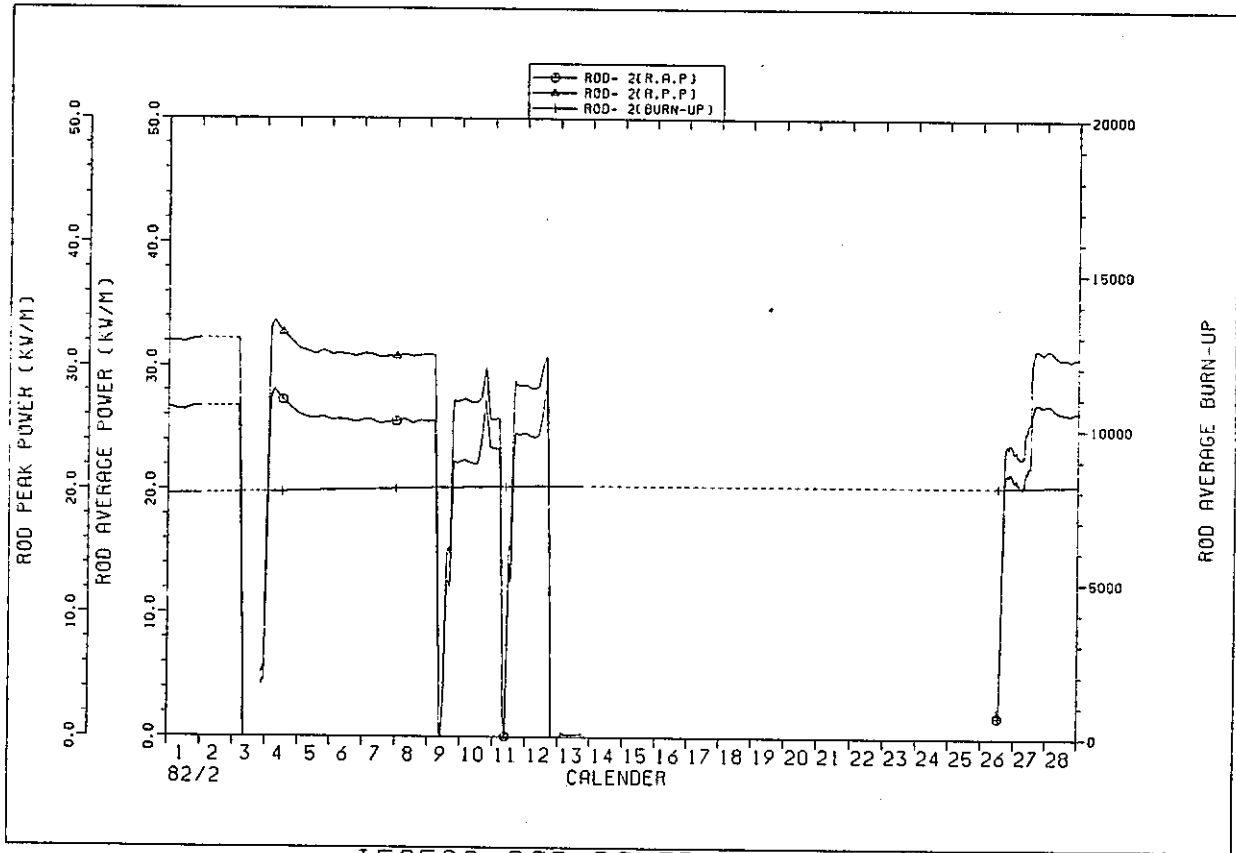

IFA529 ROD POWER HISTORY

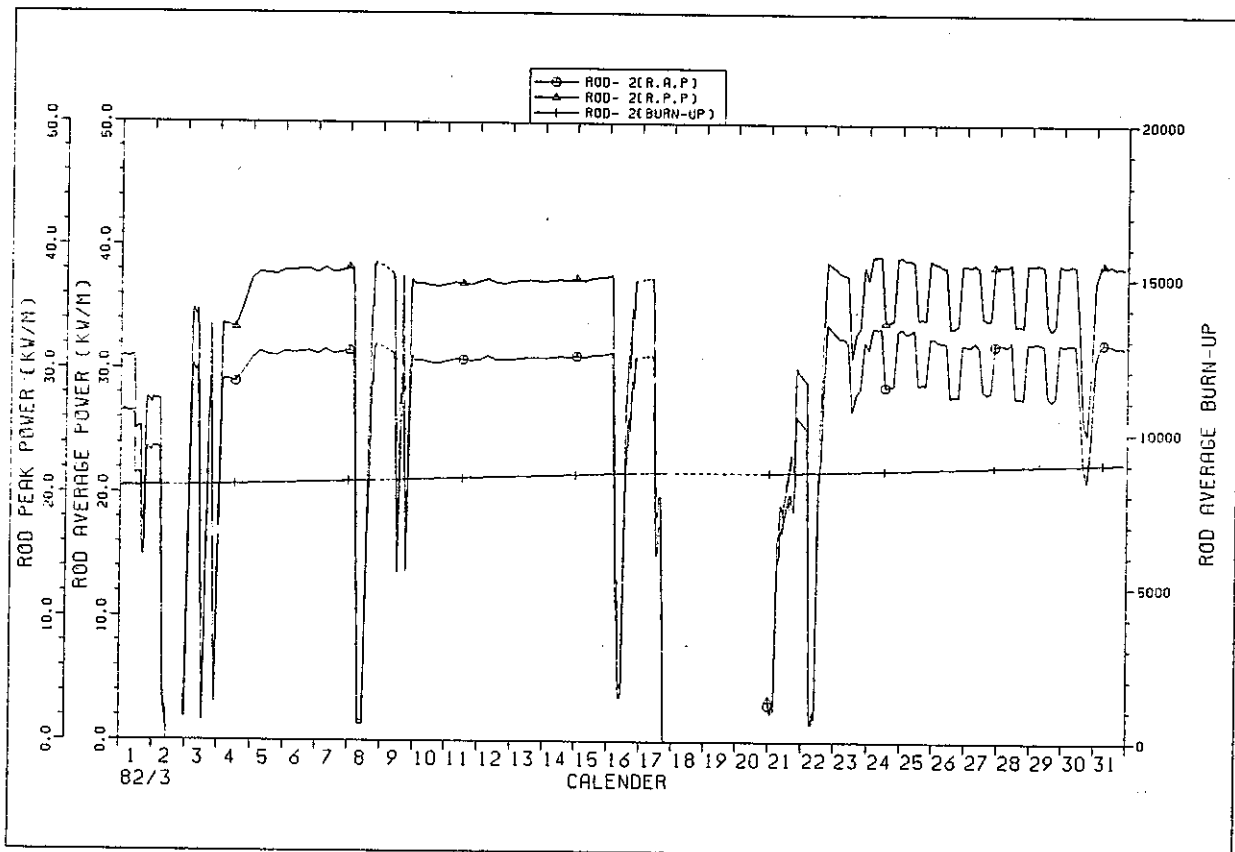

IFA529 ROD POWER HISTORY

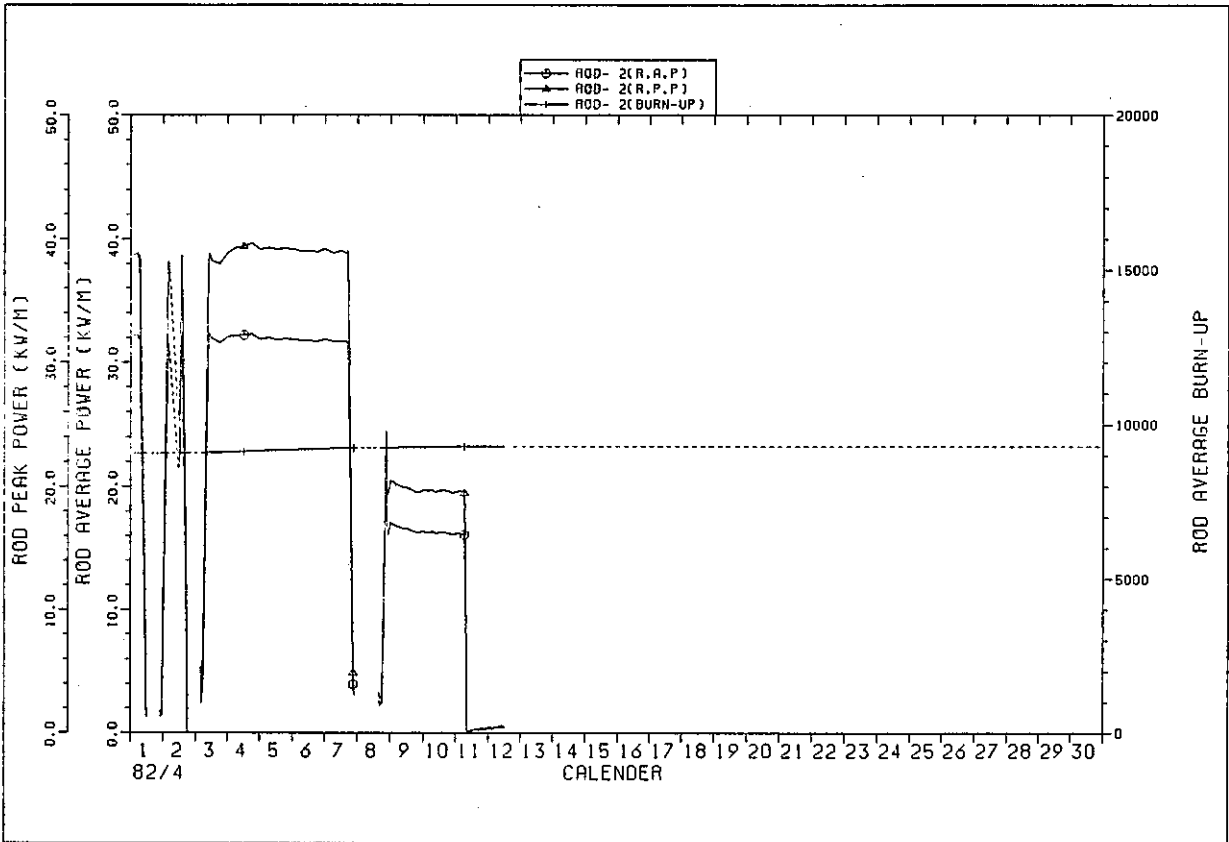

IFA529 ROD POWER HISTORY

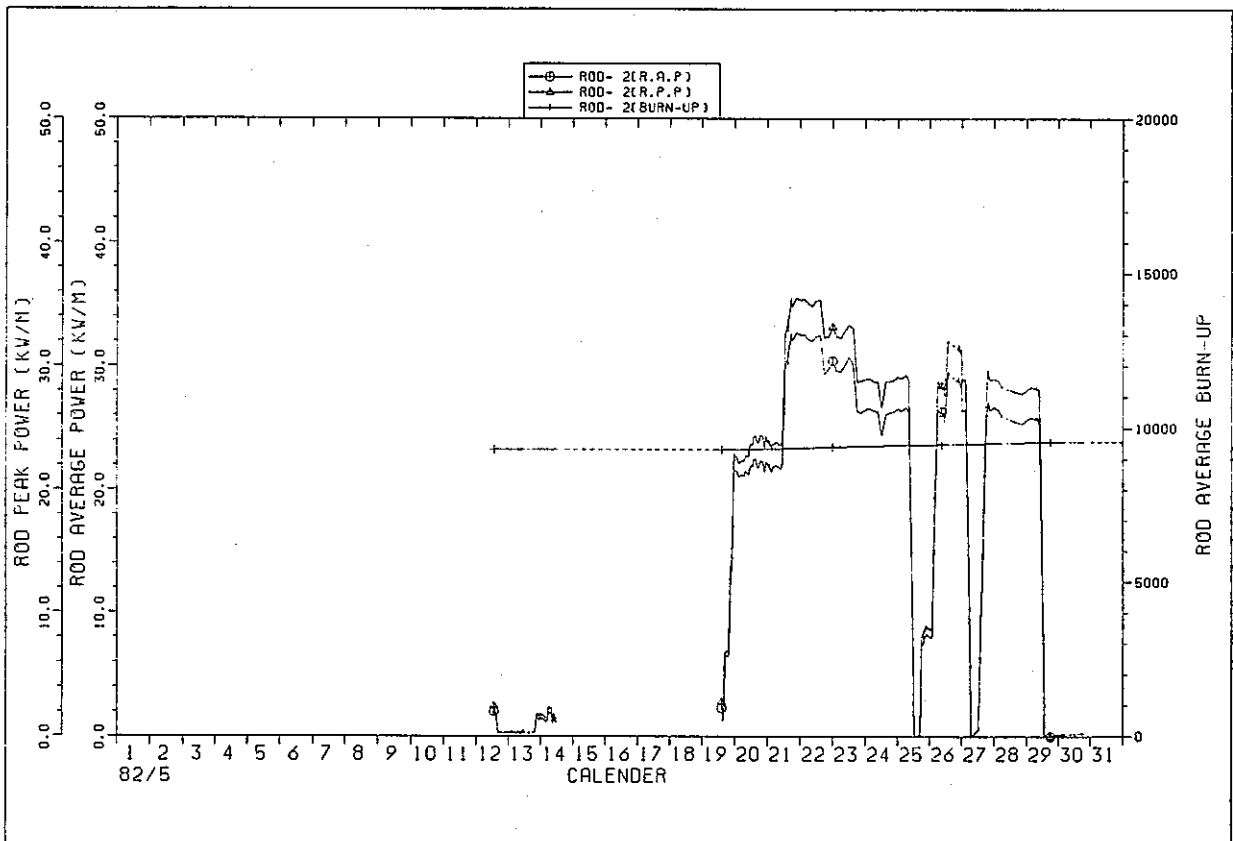

IFA529 ROD POWER HISTORY

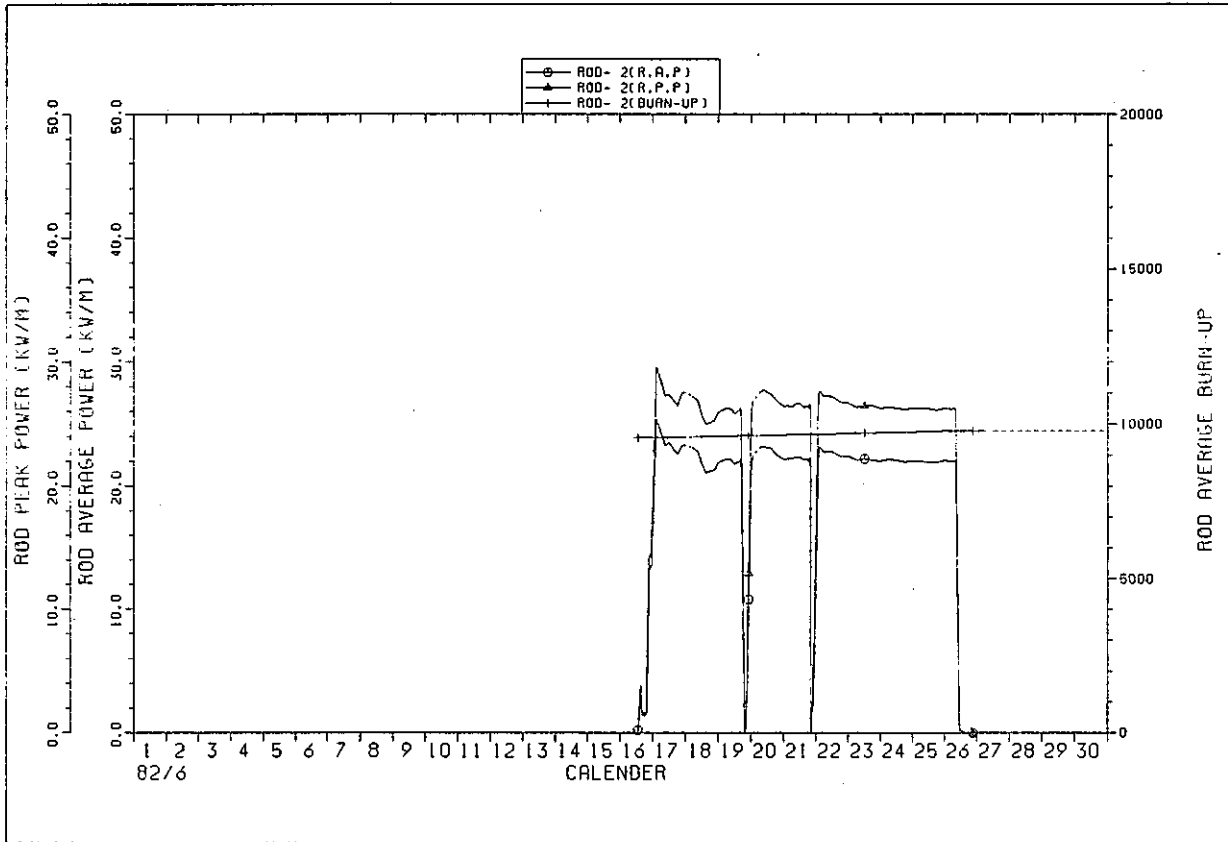

IFA529 ROD POWER HISTORY

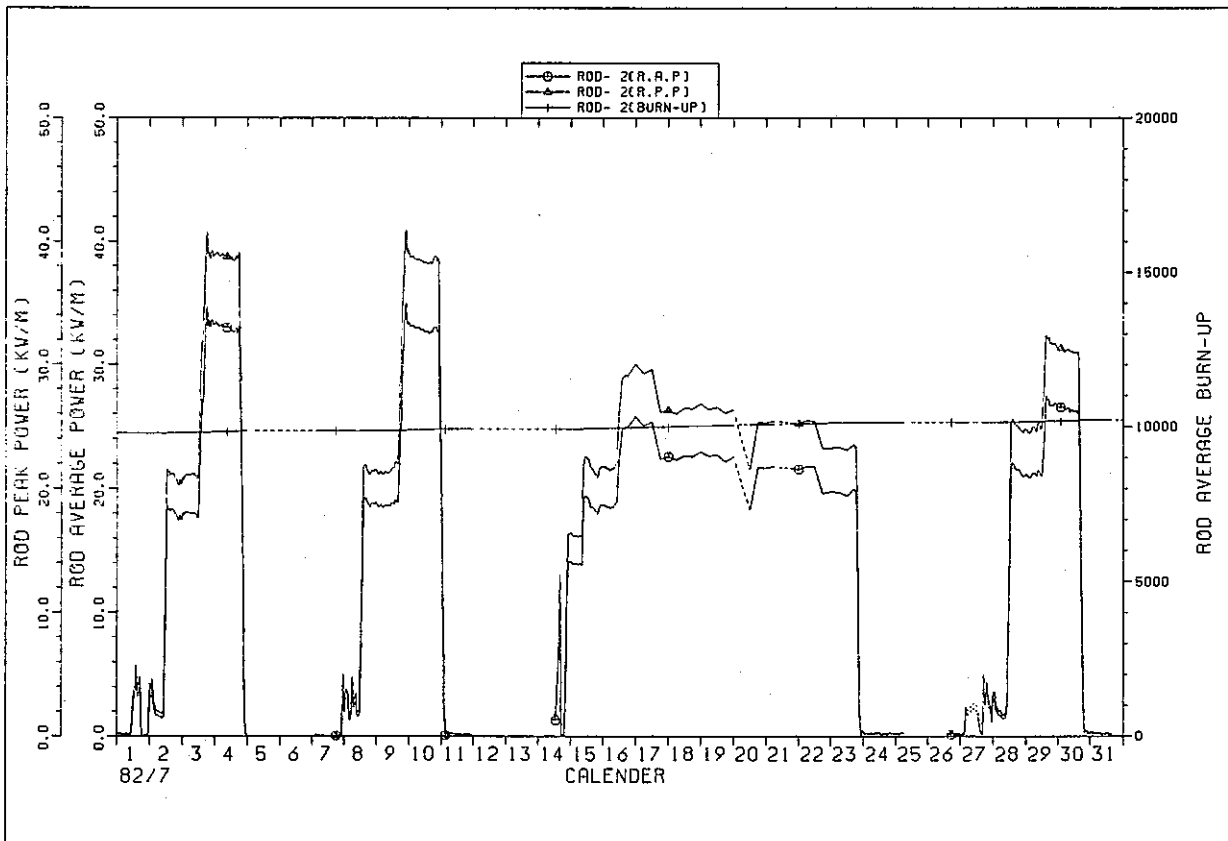

IFA529 ROD POWER HISTORY

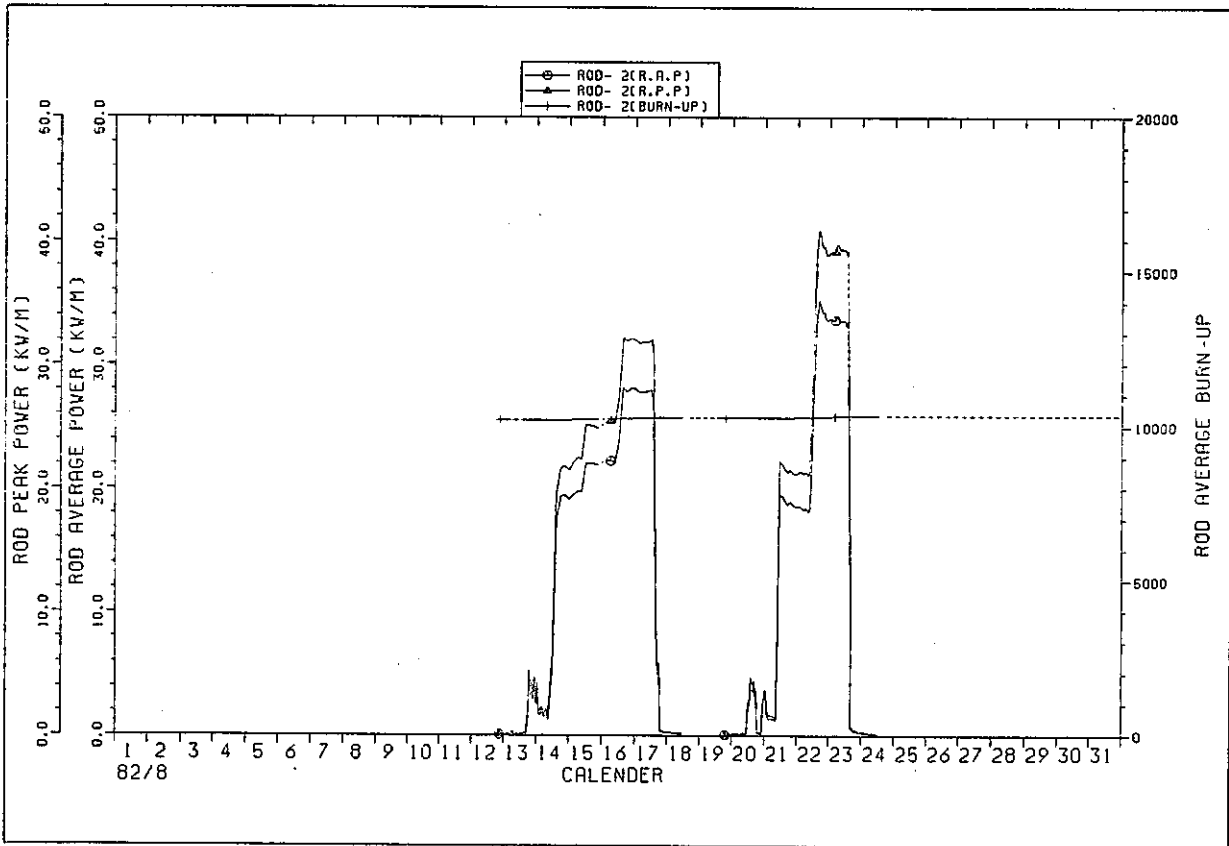

IFA529 ROD POWER HISTORY

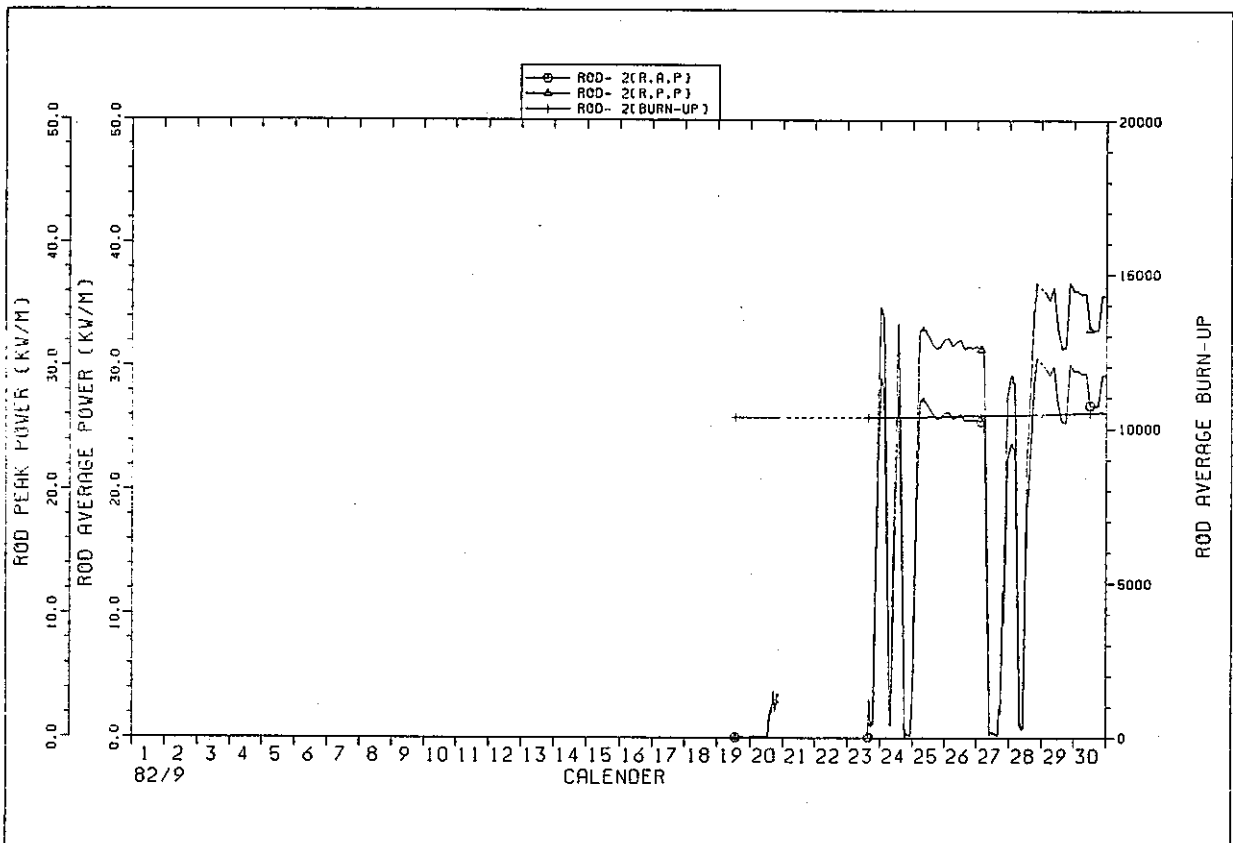

IFA529 ROD POWER HISTORY

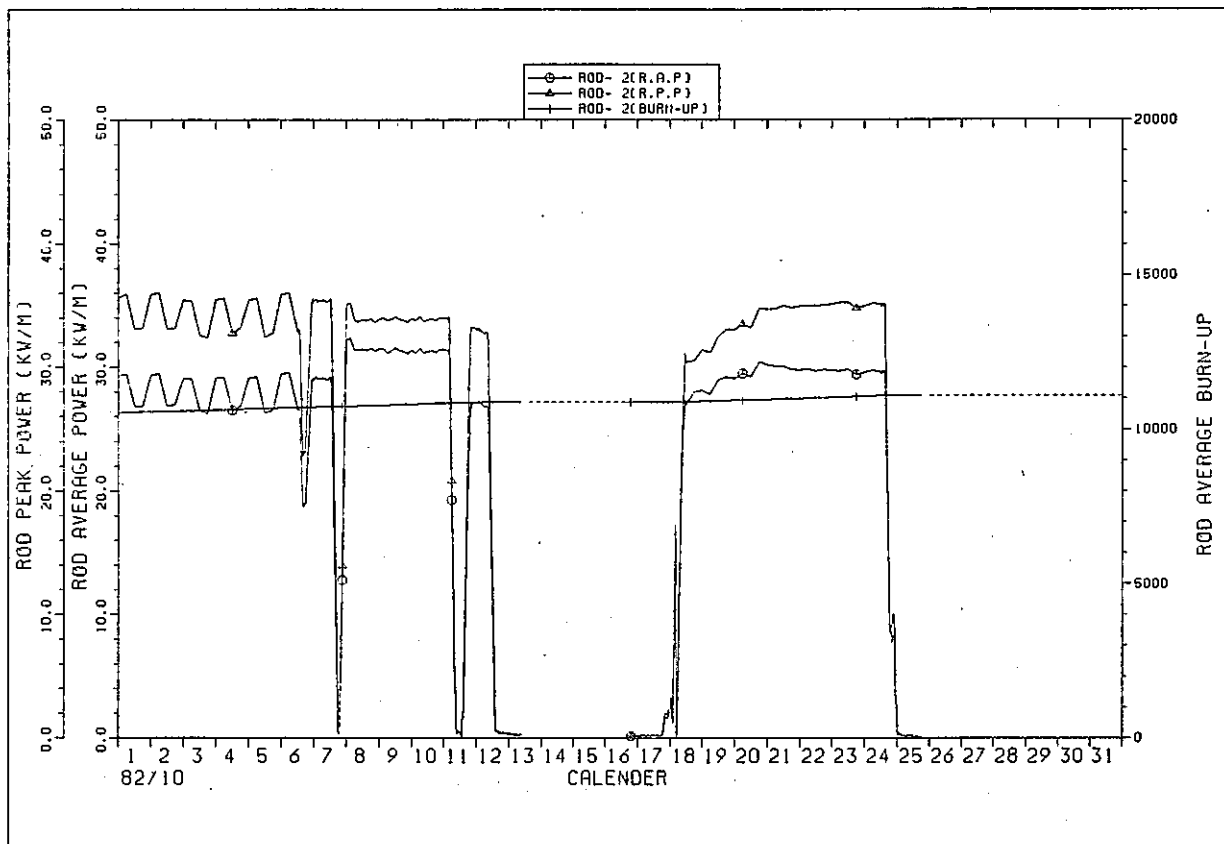

IFA529 ROD POWER HISTORY

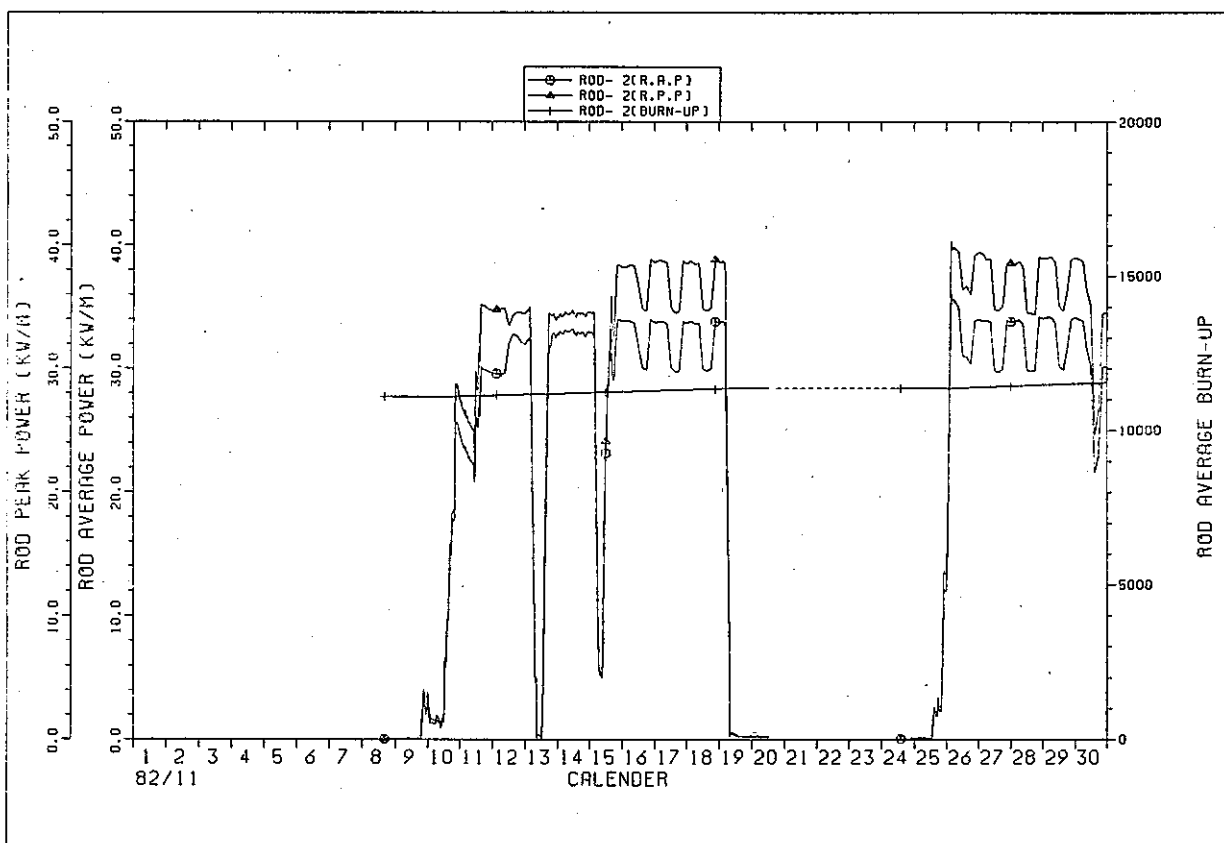

IFA529 ROD POWER HISTORY

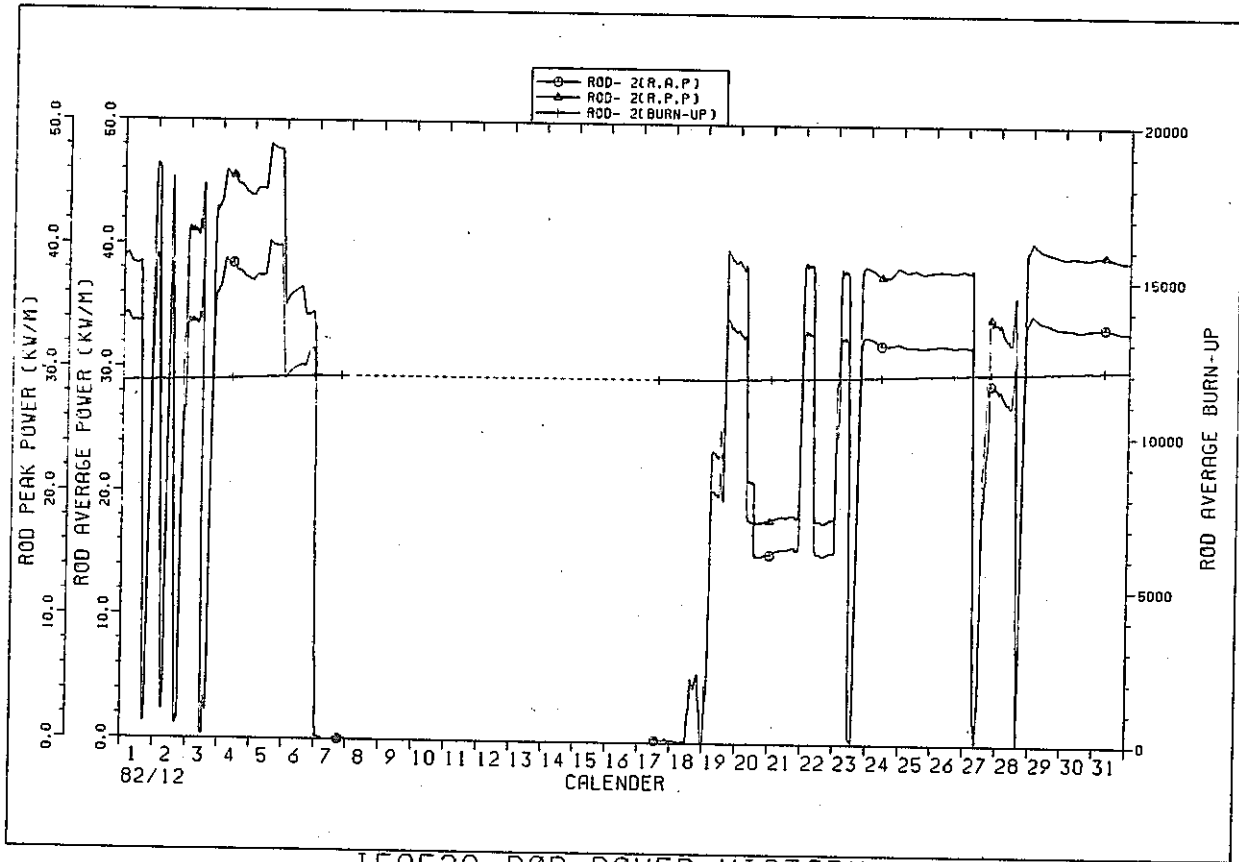

IFA529 ROD POWER HISTORY

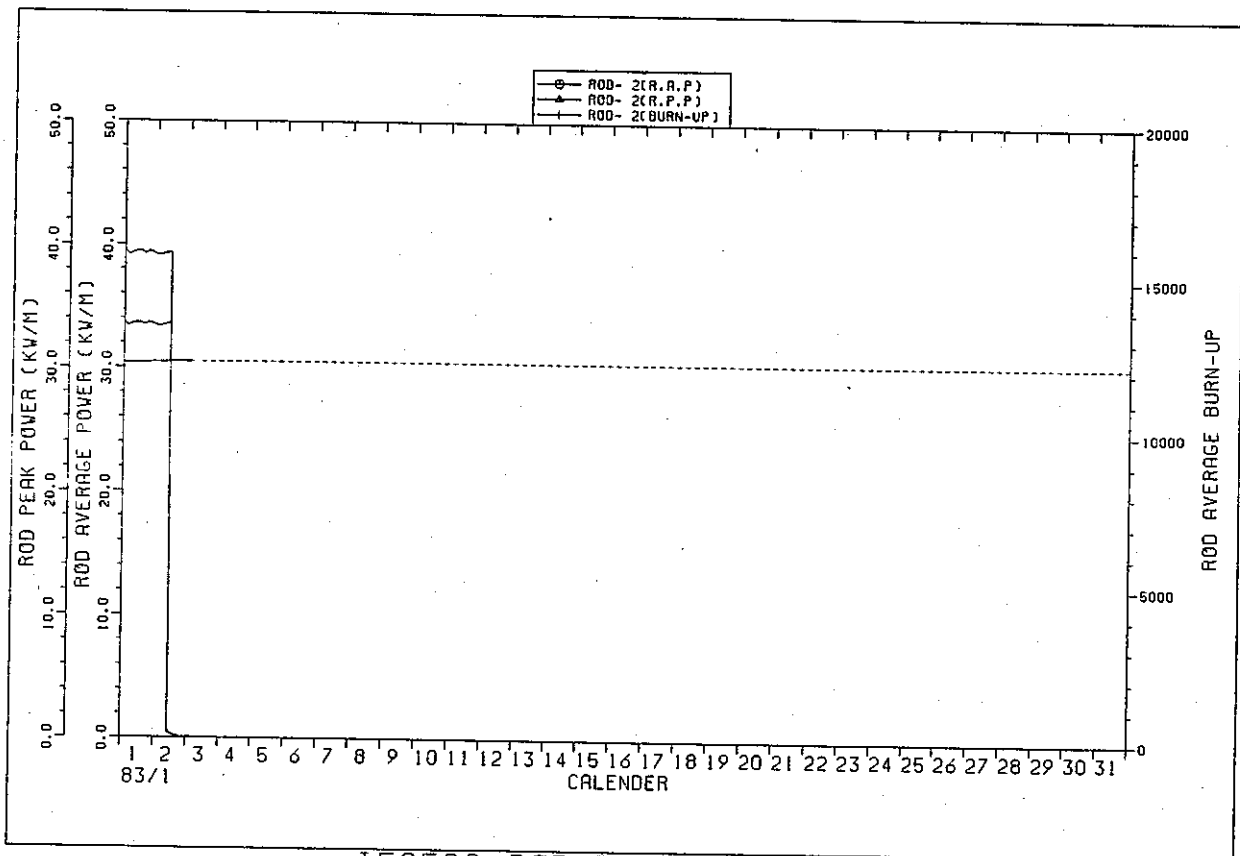

IFA529 ROD POWER HISTORY

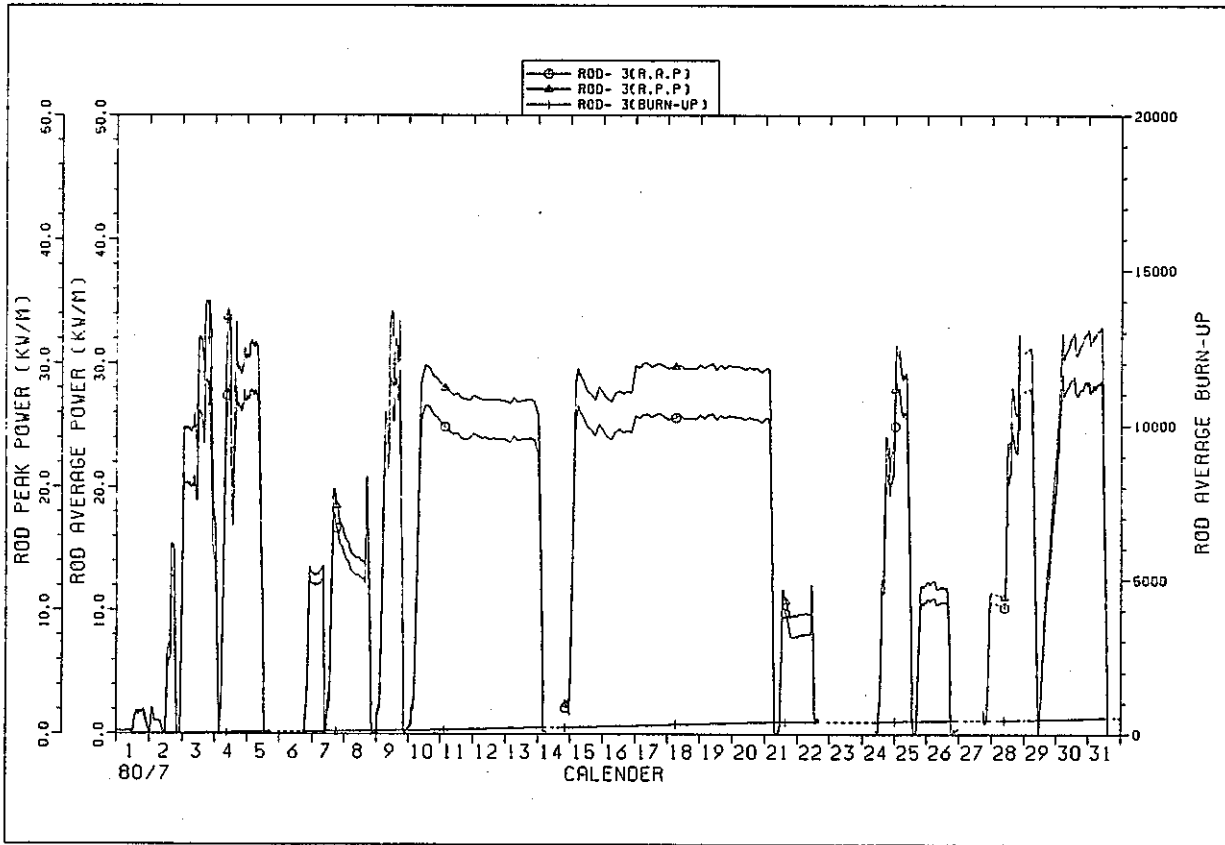

IFA529 ROD POWER HISTORY

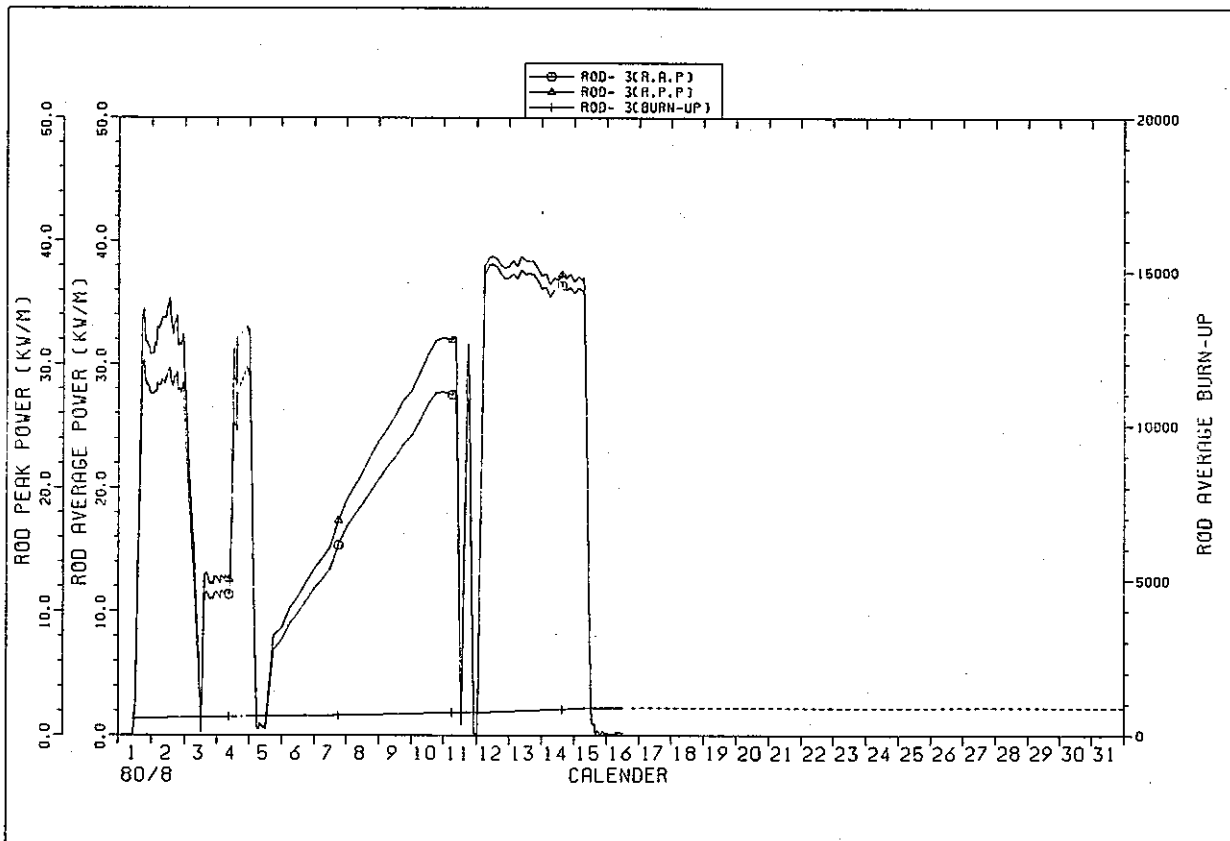

IFA529 ROD POWER HISTORY

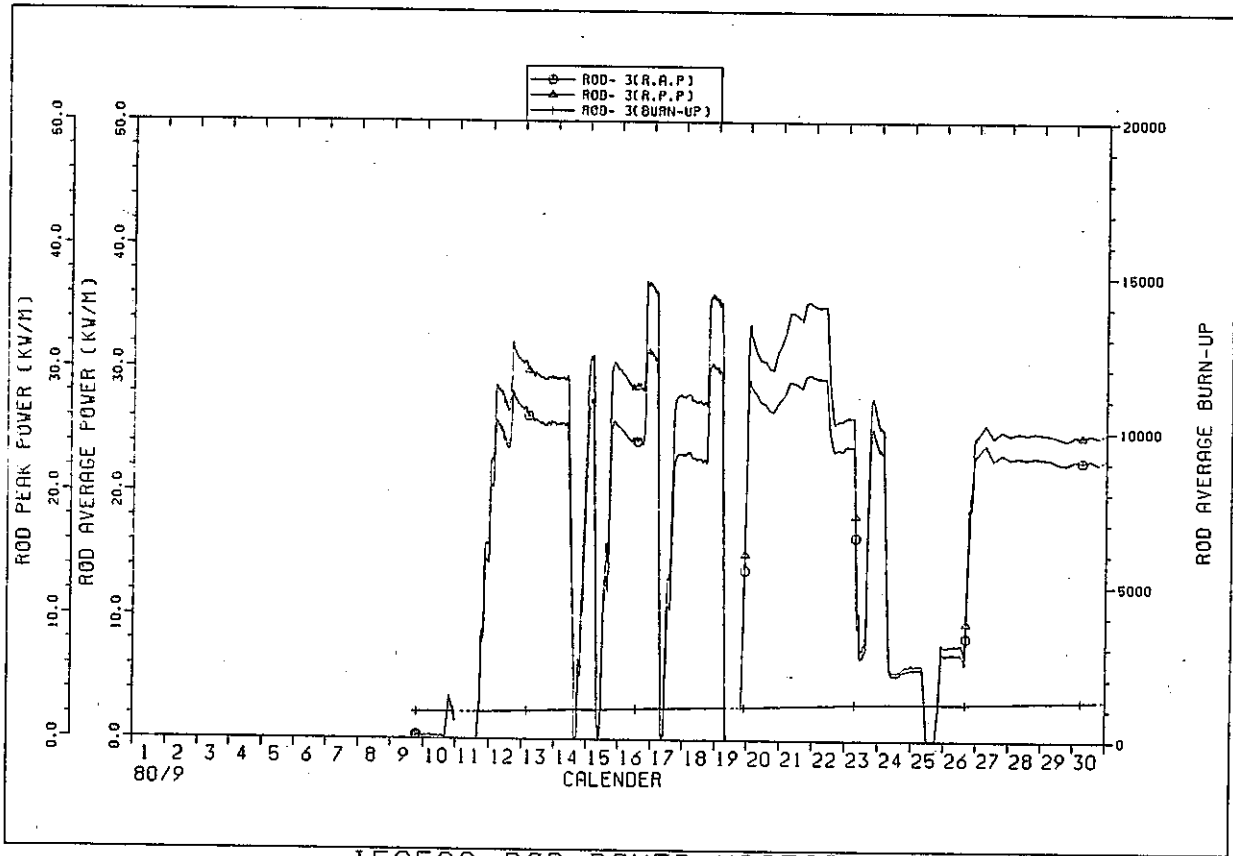

IFA529 ROD POWER HISTORY

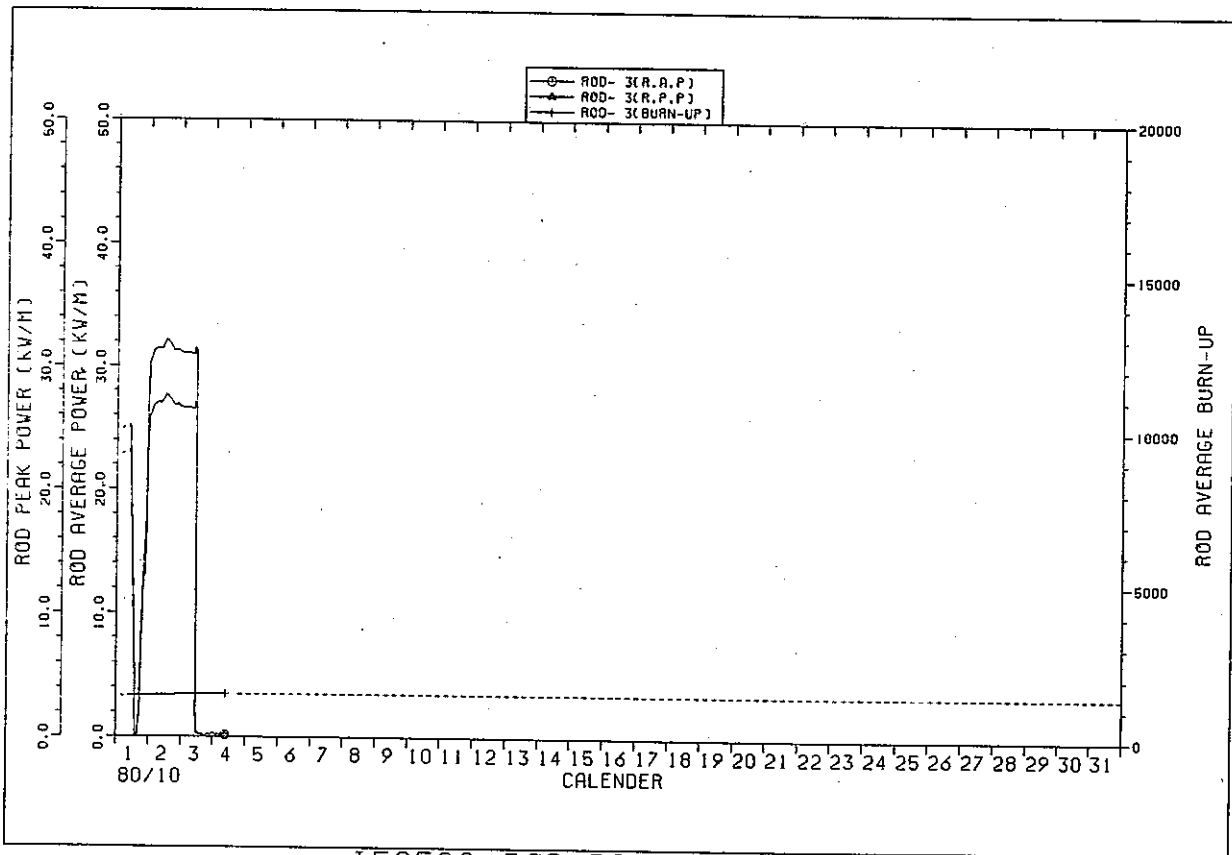

IFA529 ROD POWER HISTORY

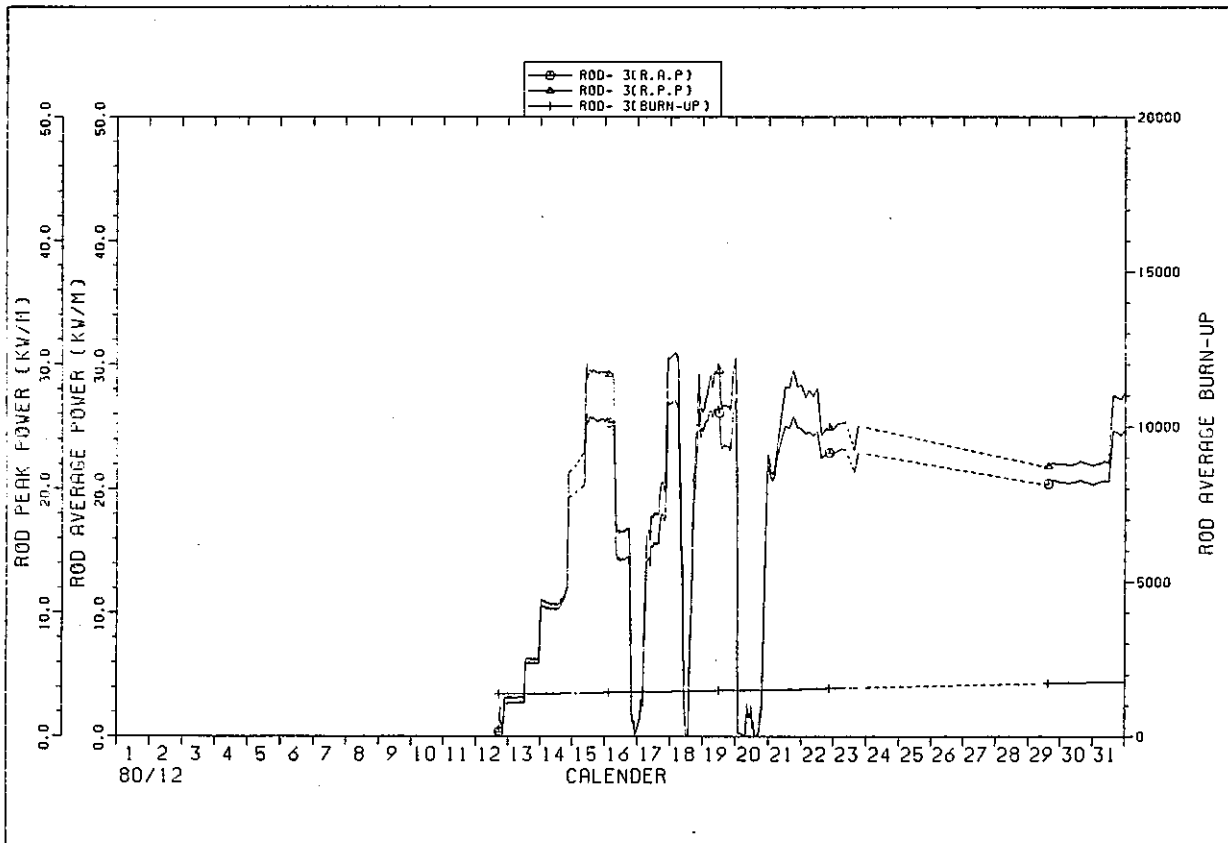

IFA529 ROD POWER HISTORY

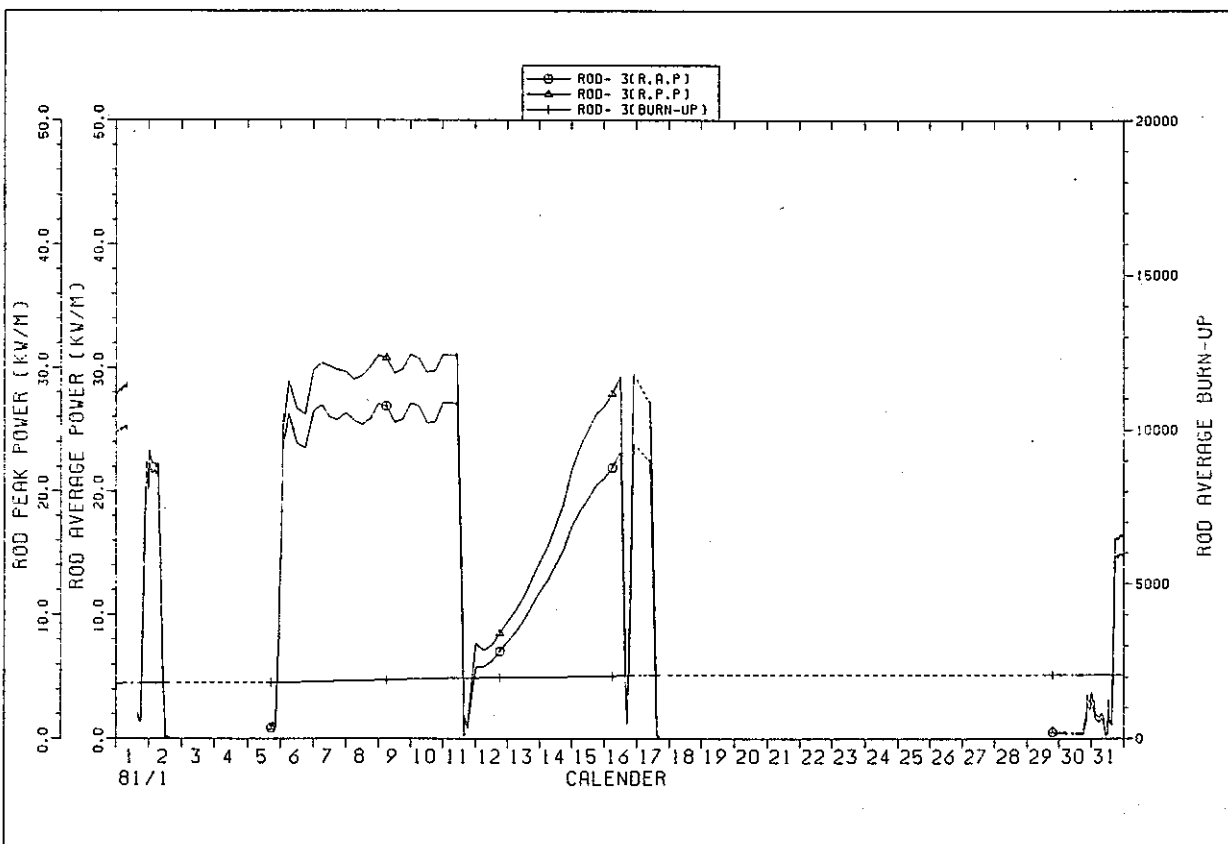

IFA529 ROD POWER HISTORY

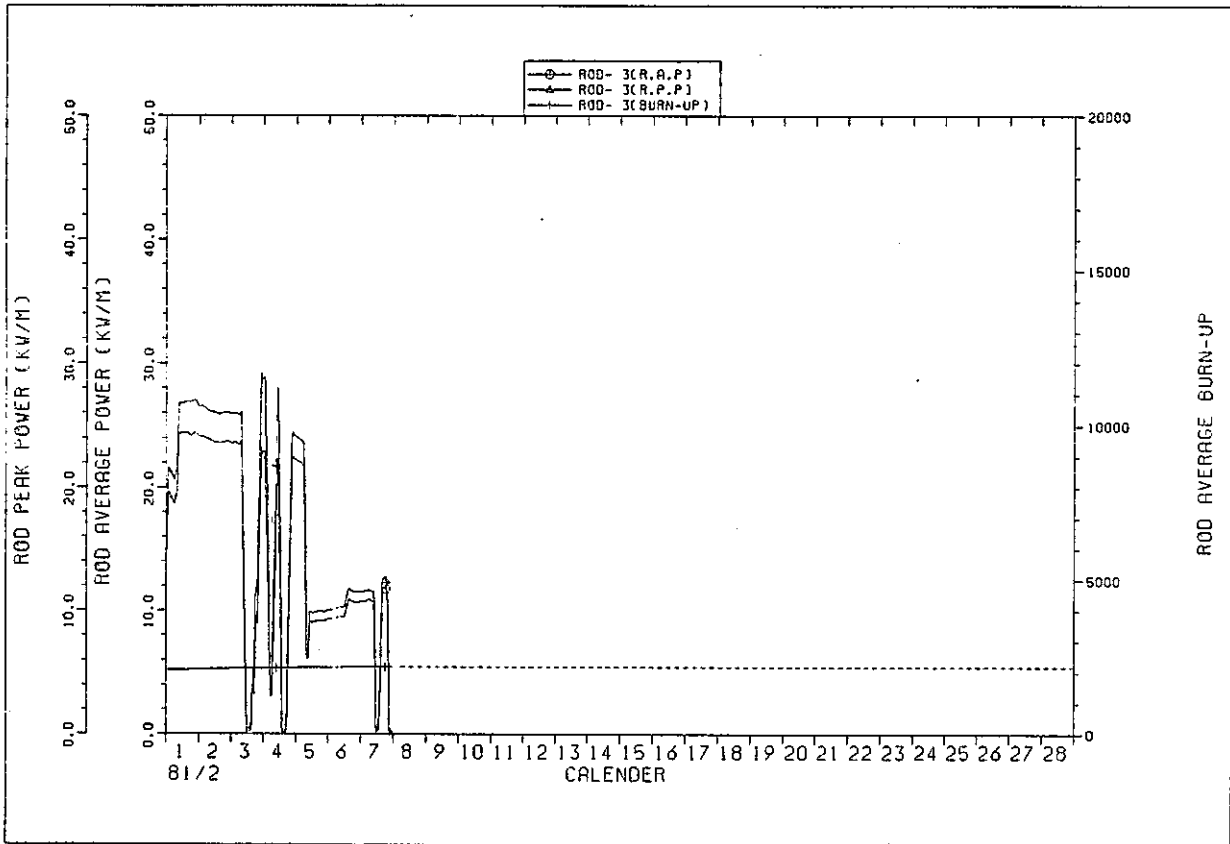

IFA529 ROD POWER HISTORY

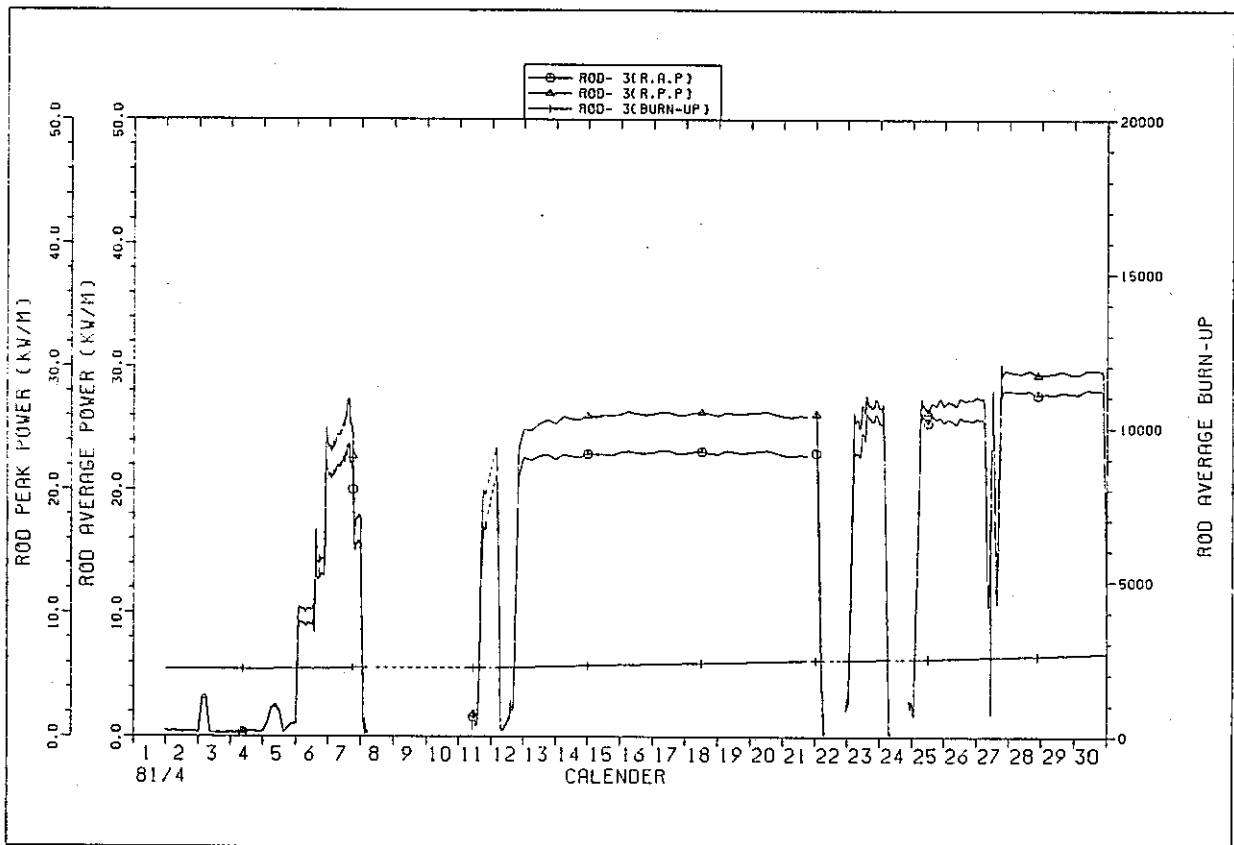

IFA529 ROD POWER HISTORY

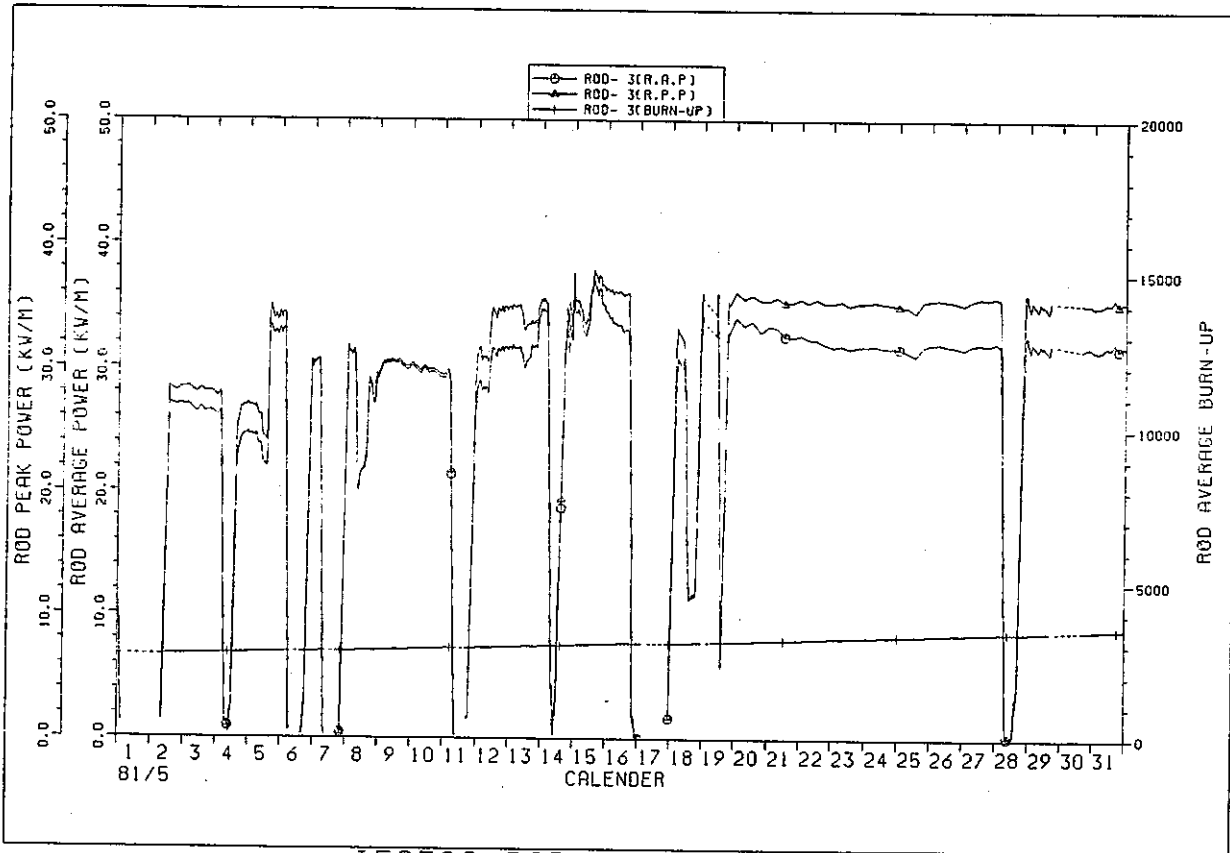

IFA529 ROD POWER HISTORY

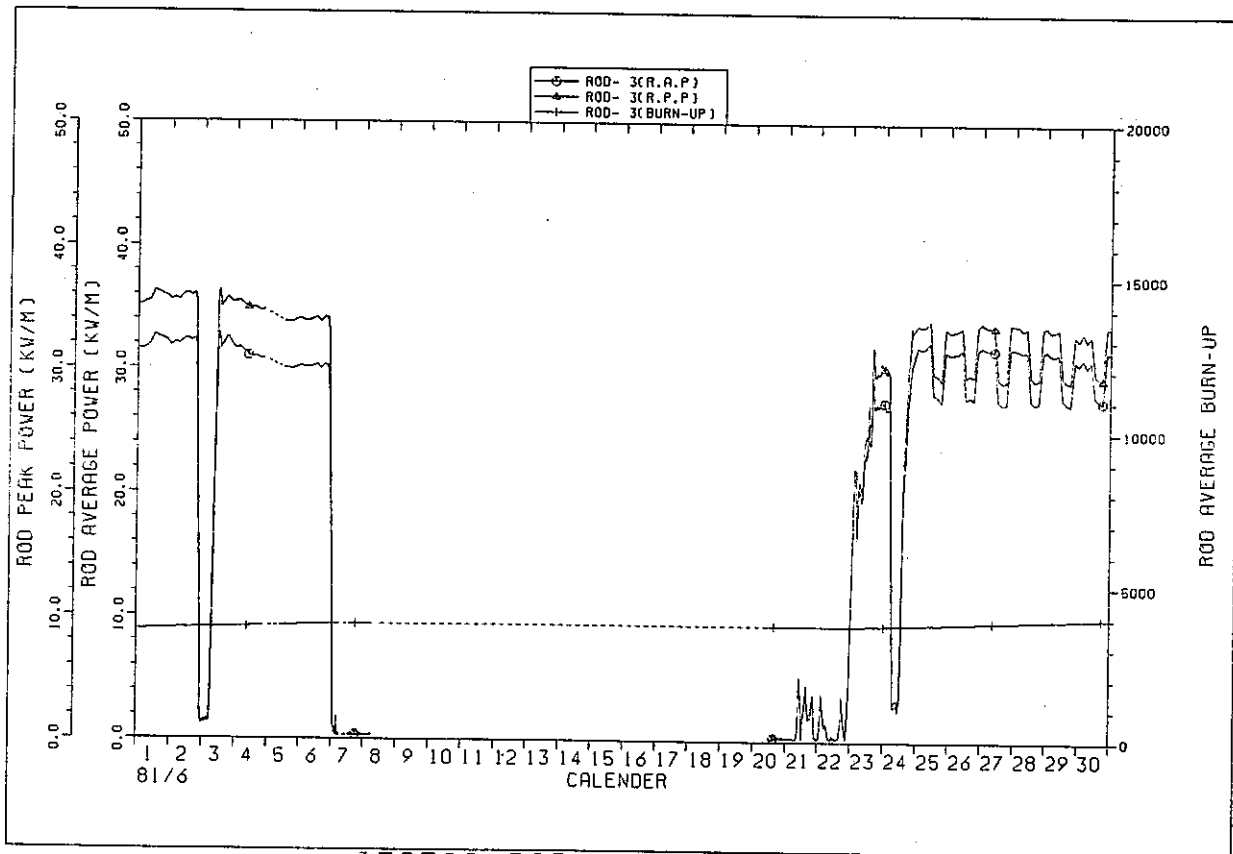

IFA529 ROD POWER HISTORY

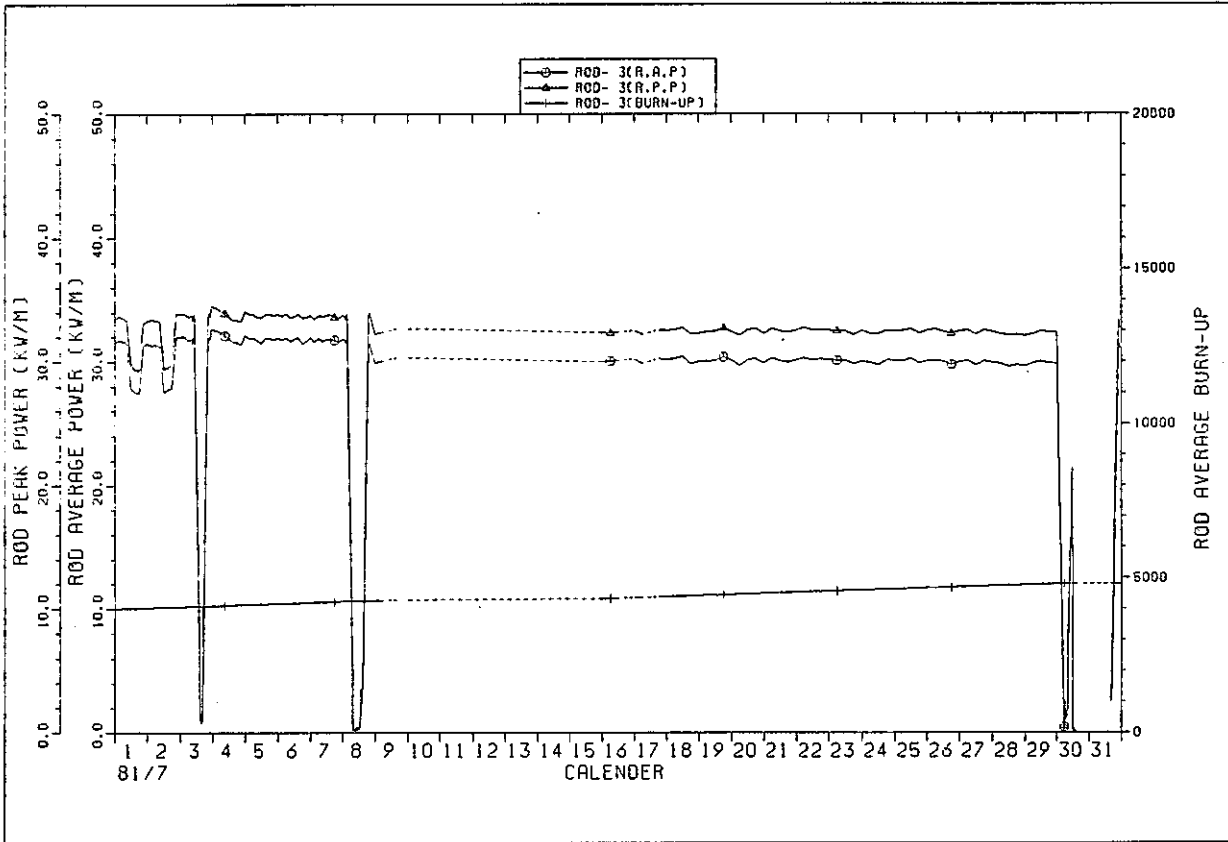

IFA529 ROD POWER HISTORY

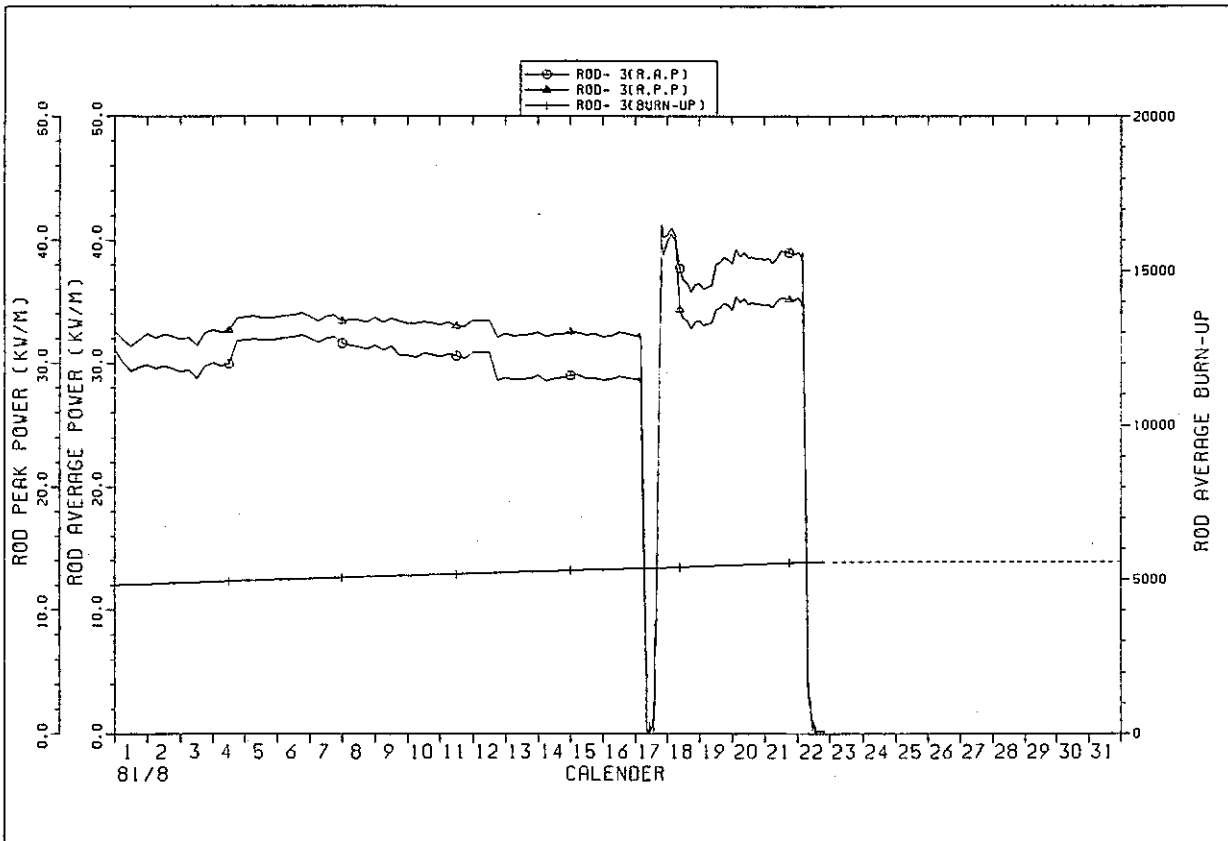

IFA529 ROD POWER HISTORY

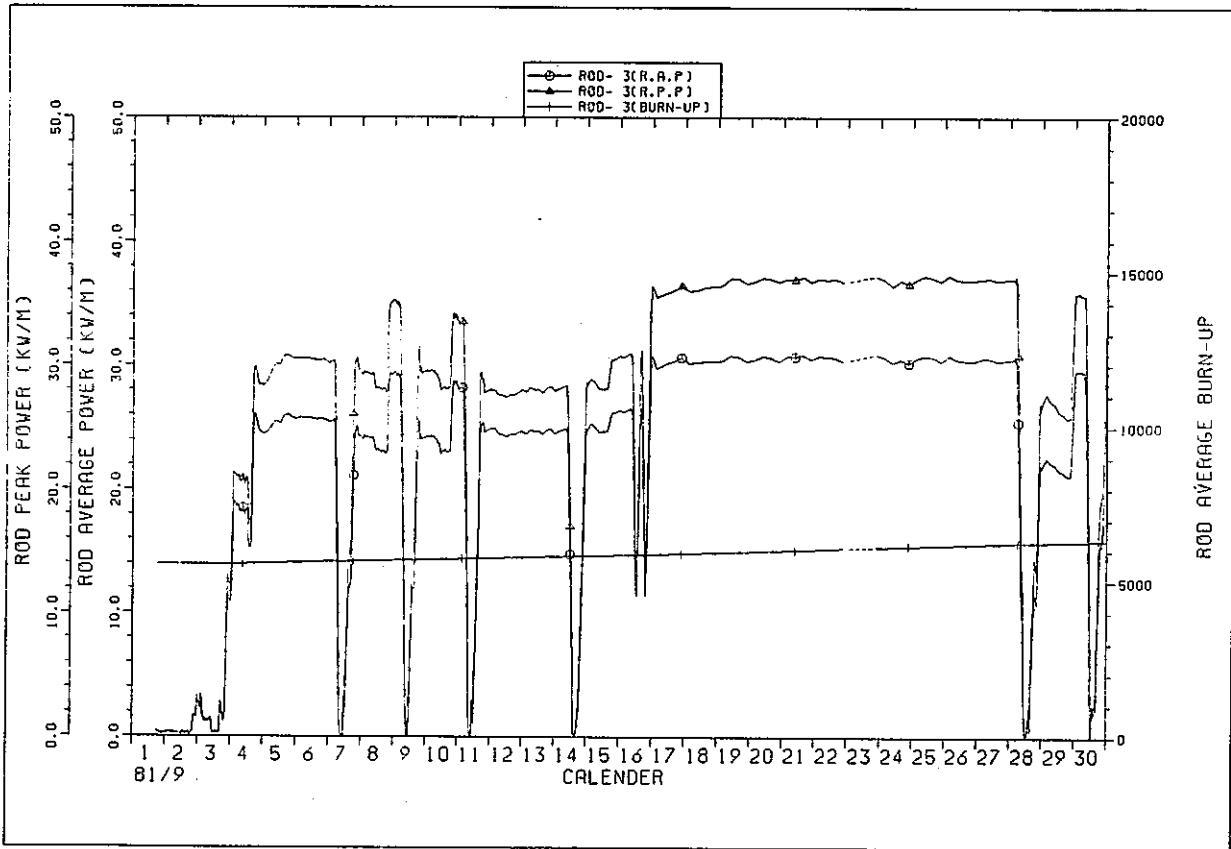

IFA529 ROD POWER HISTORY

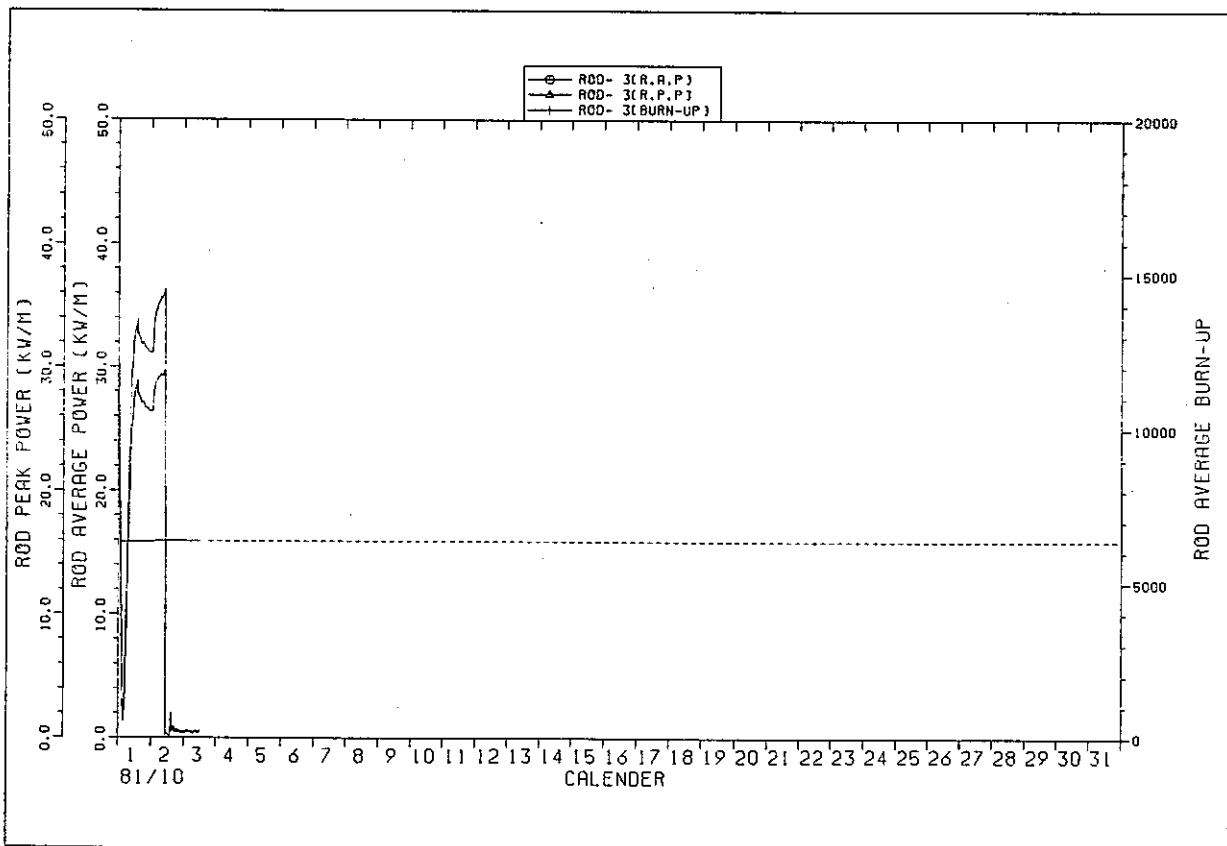

IFA529 ROD POWER HISTORY

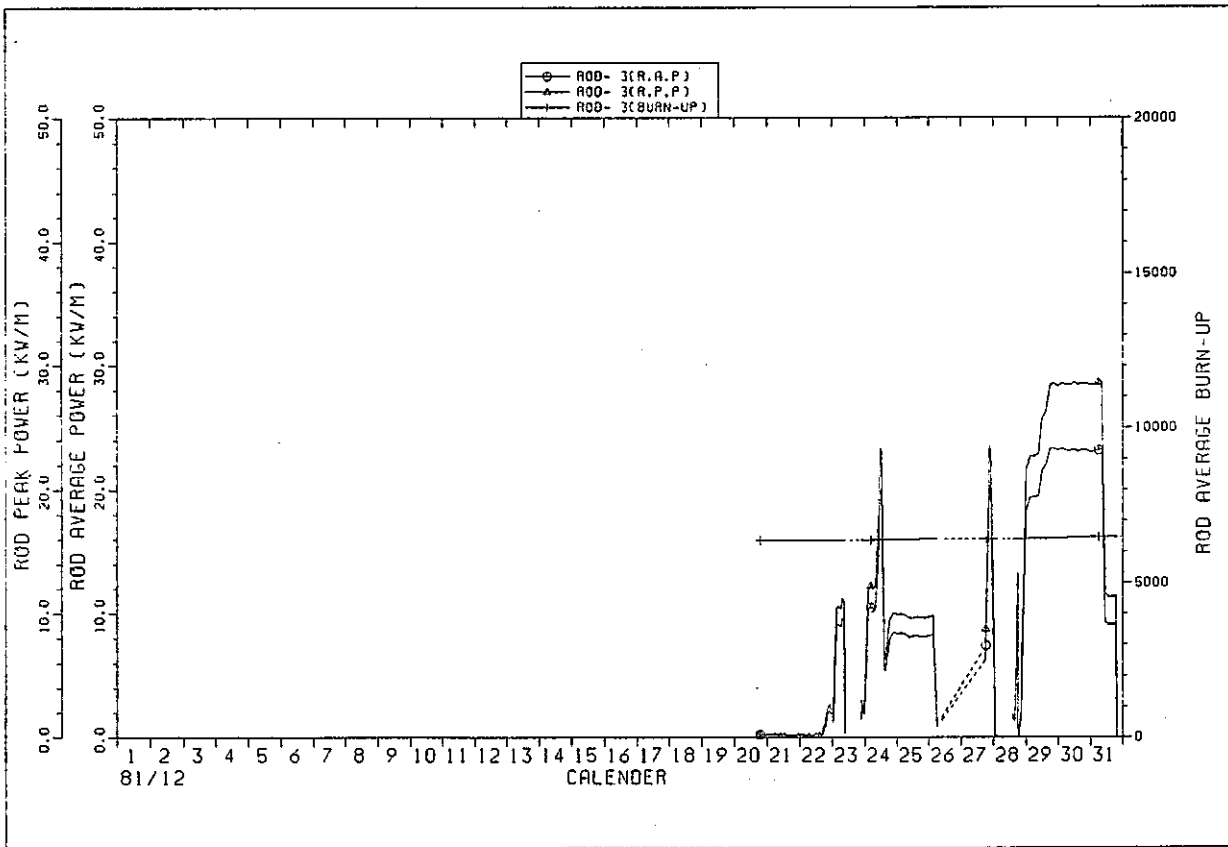

IFA529 ROD POWER HISTORY

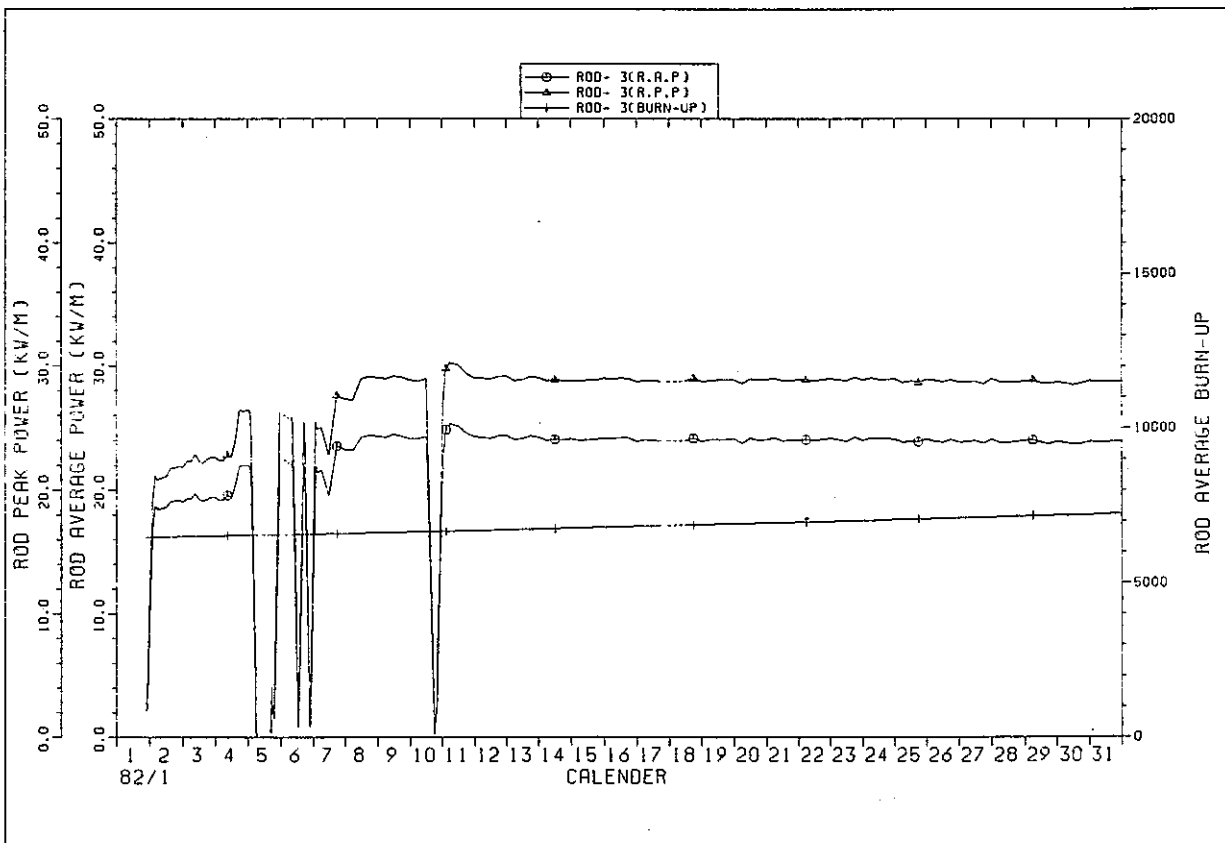

IFA529 ROD POWER HISTORY

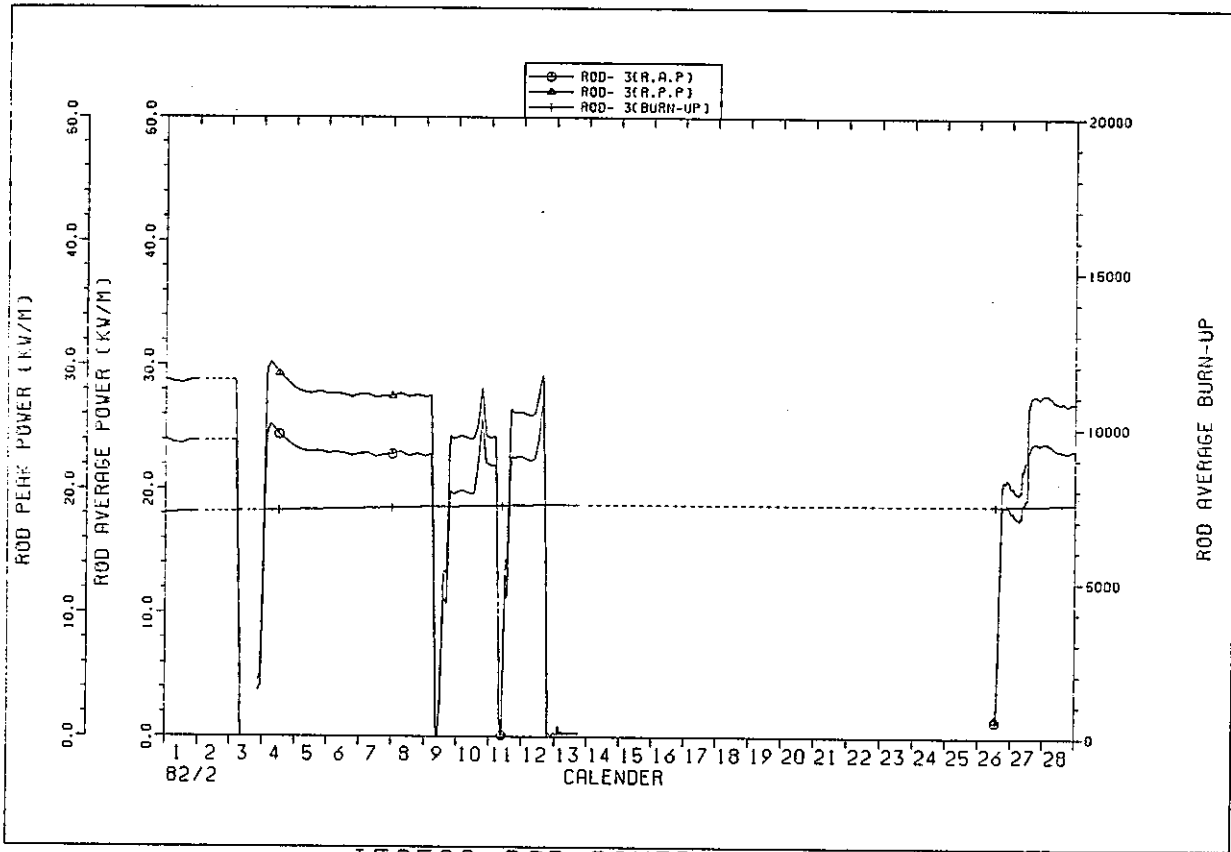

IFA529 ROD POWER HISTORY

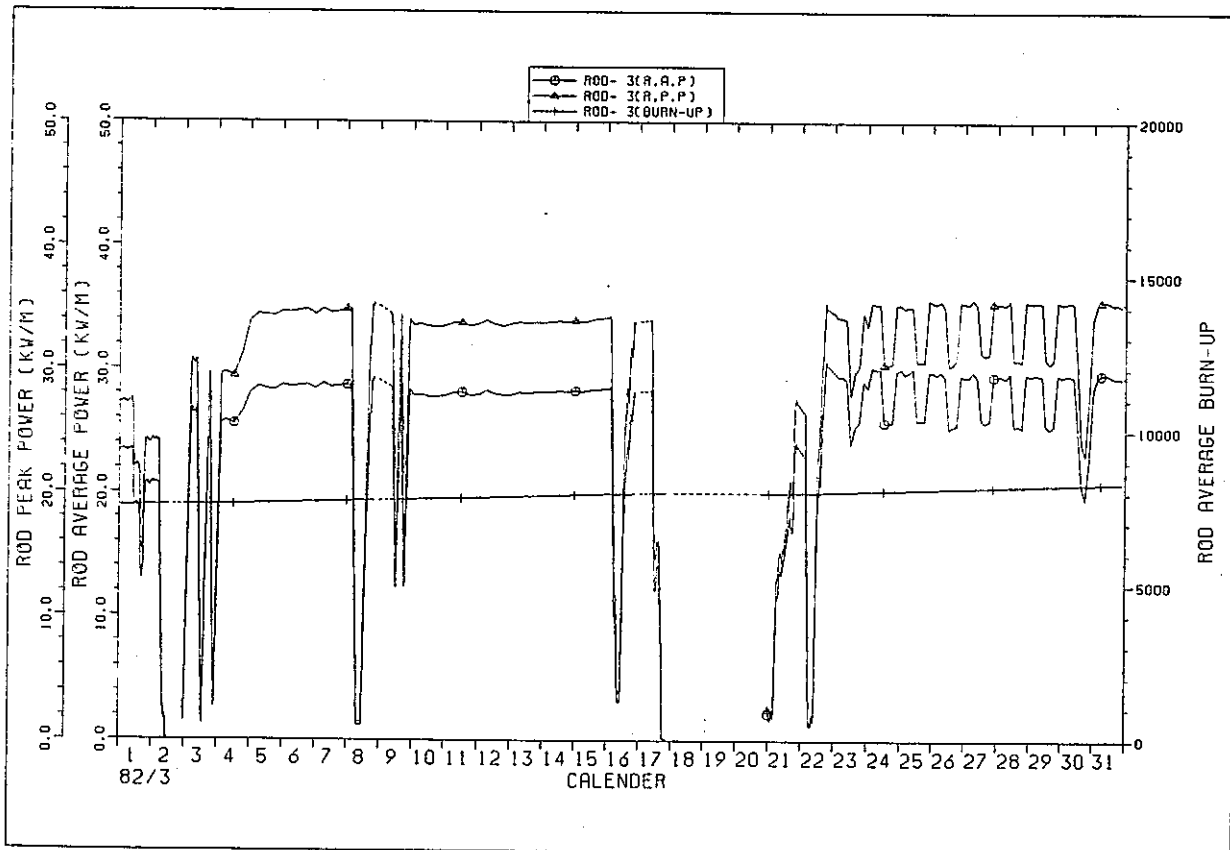

IFA529 ROD POWER HISTORY

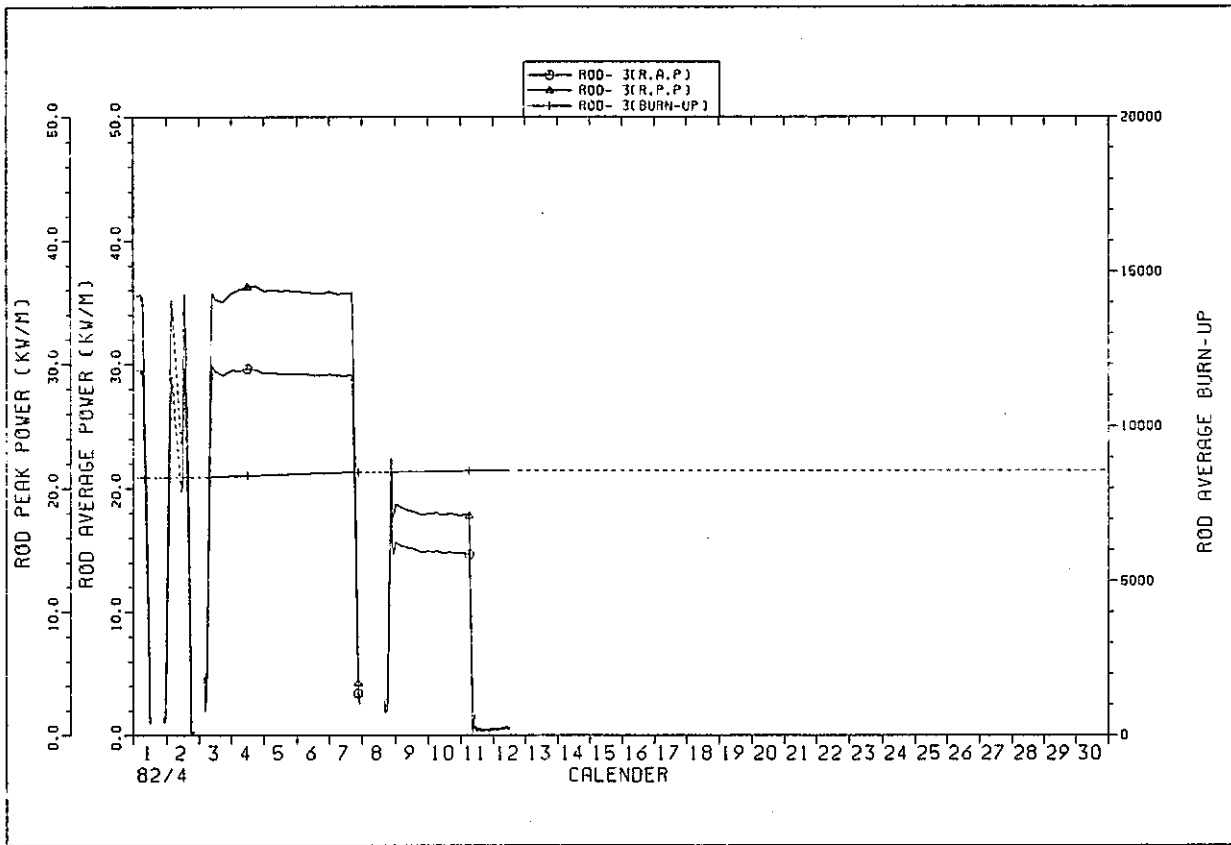

IFA529 ROD POWER HISTORY

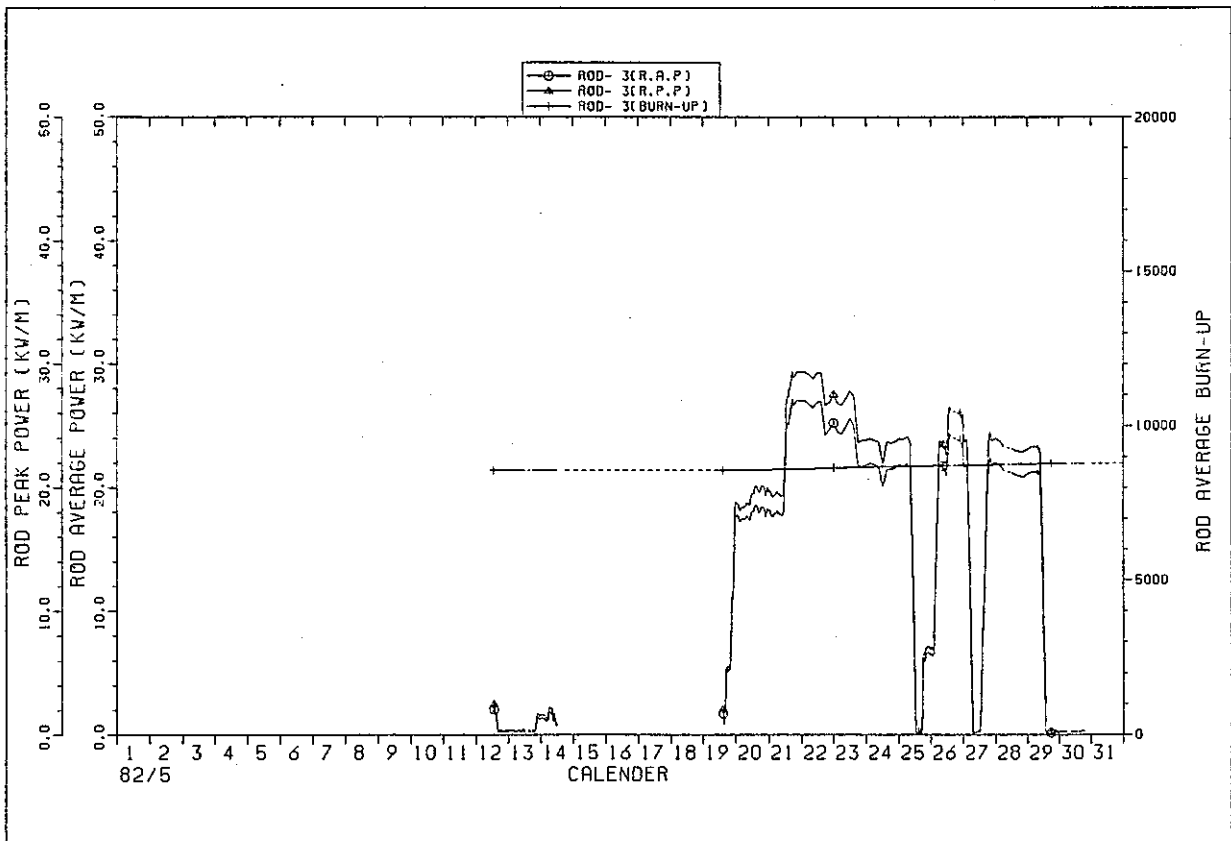

IFA529 ROD POWER HISTORY

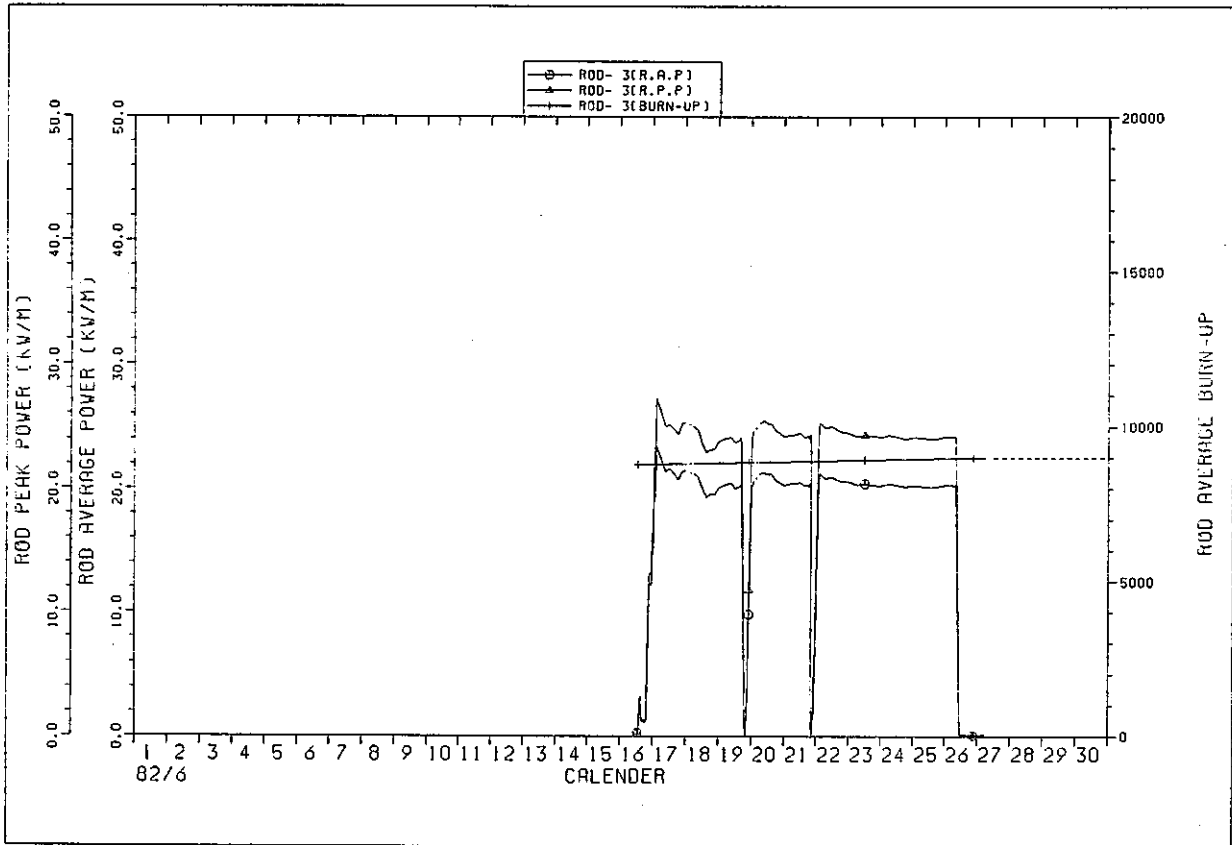

IFA529 ROD POWER HISTORY

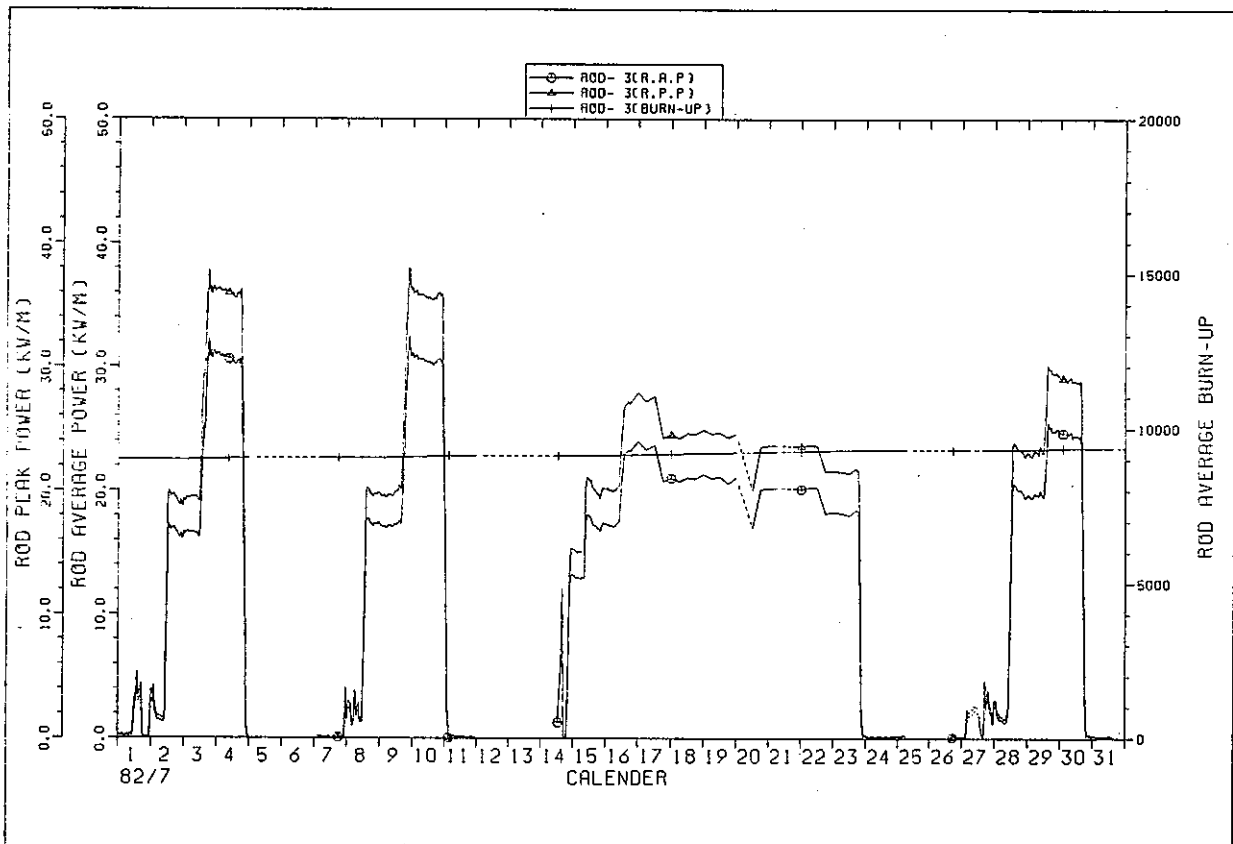

IFA529 ROD POWER HISTORY

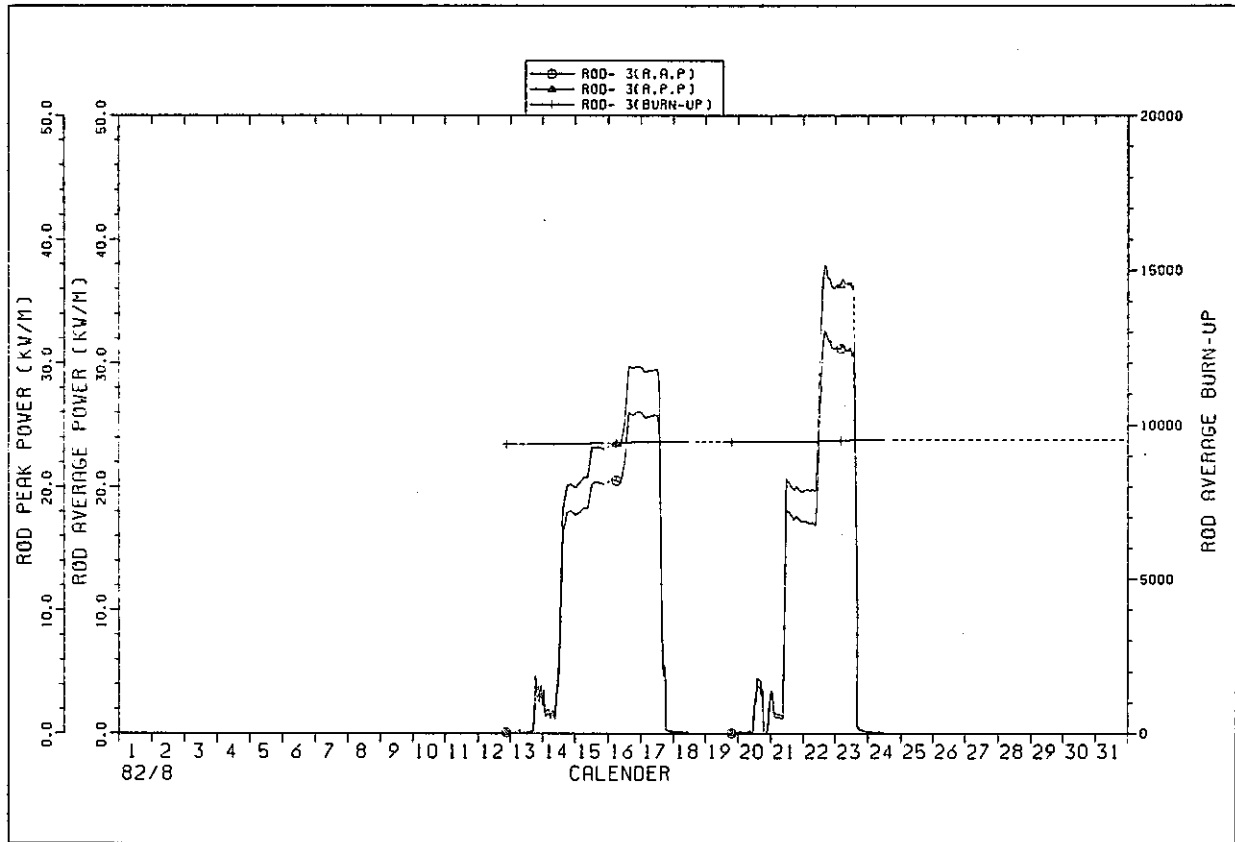

IFA529 ROD POWER HISTORY

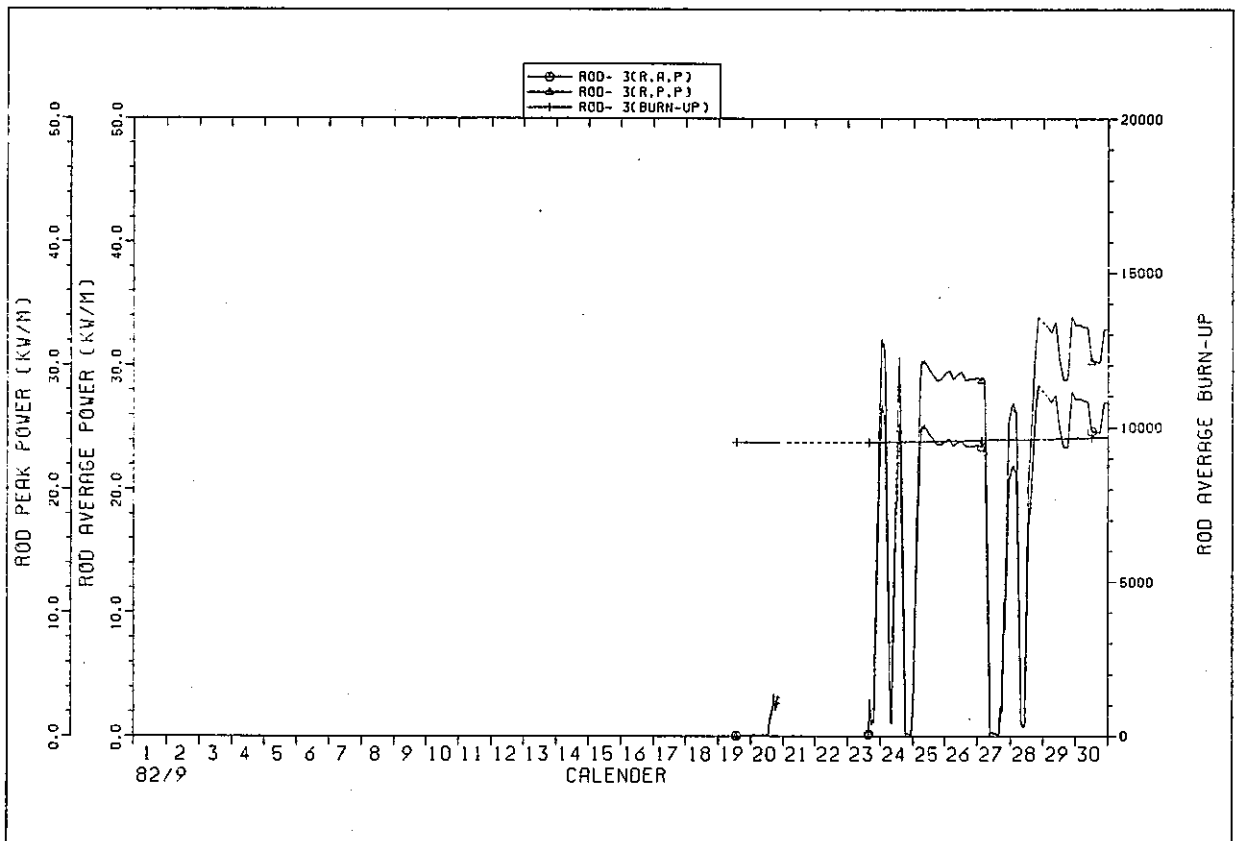

IFA529 ROD POWER HISTORY

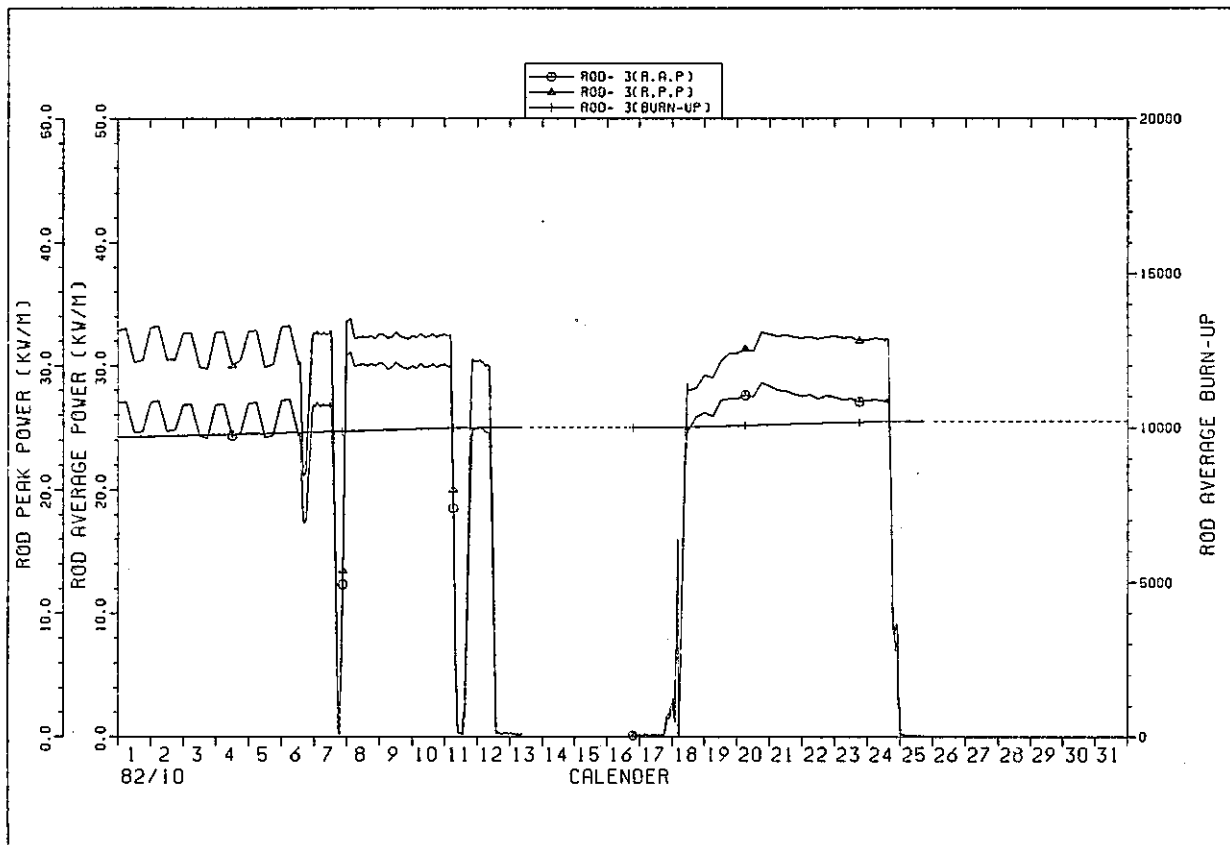

IFA529 ROD POWER HISTORY

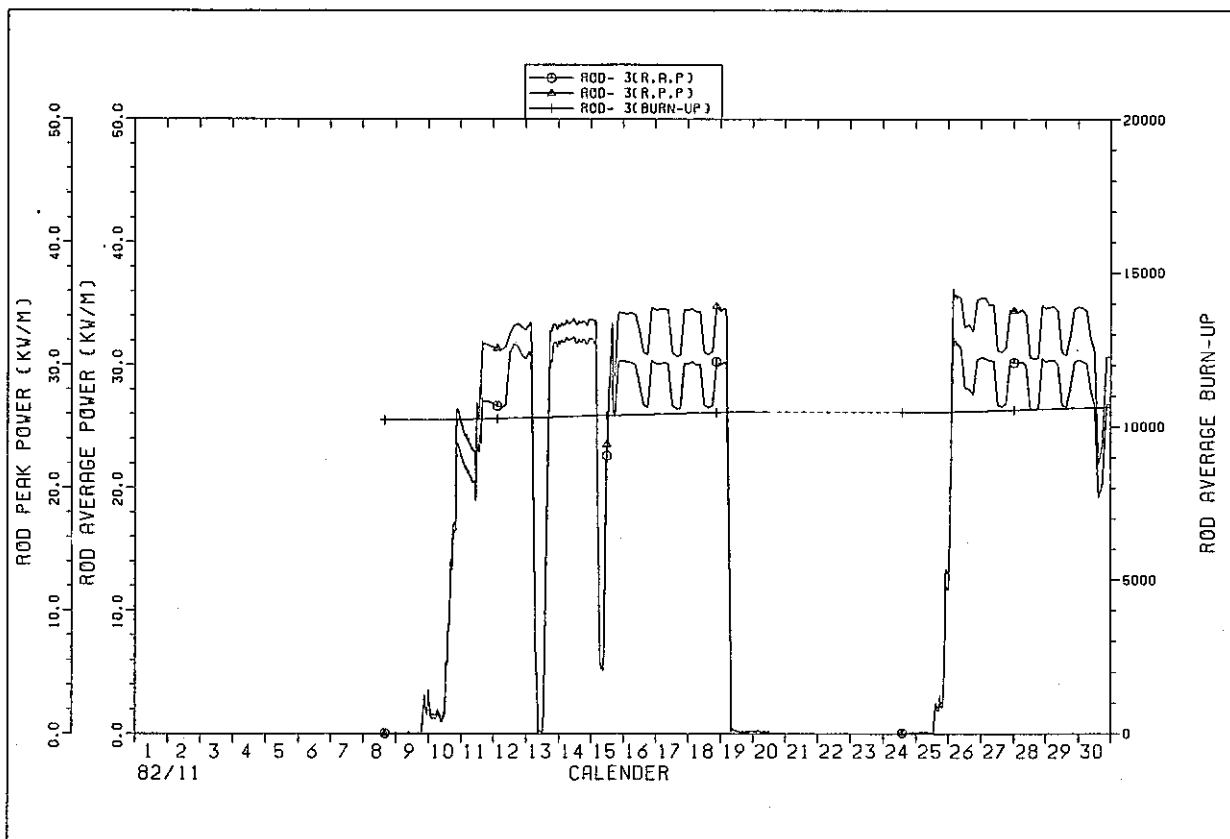

IFA529 ROD POWER HISTORY

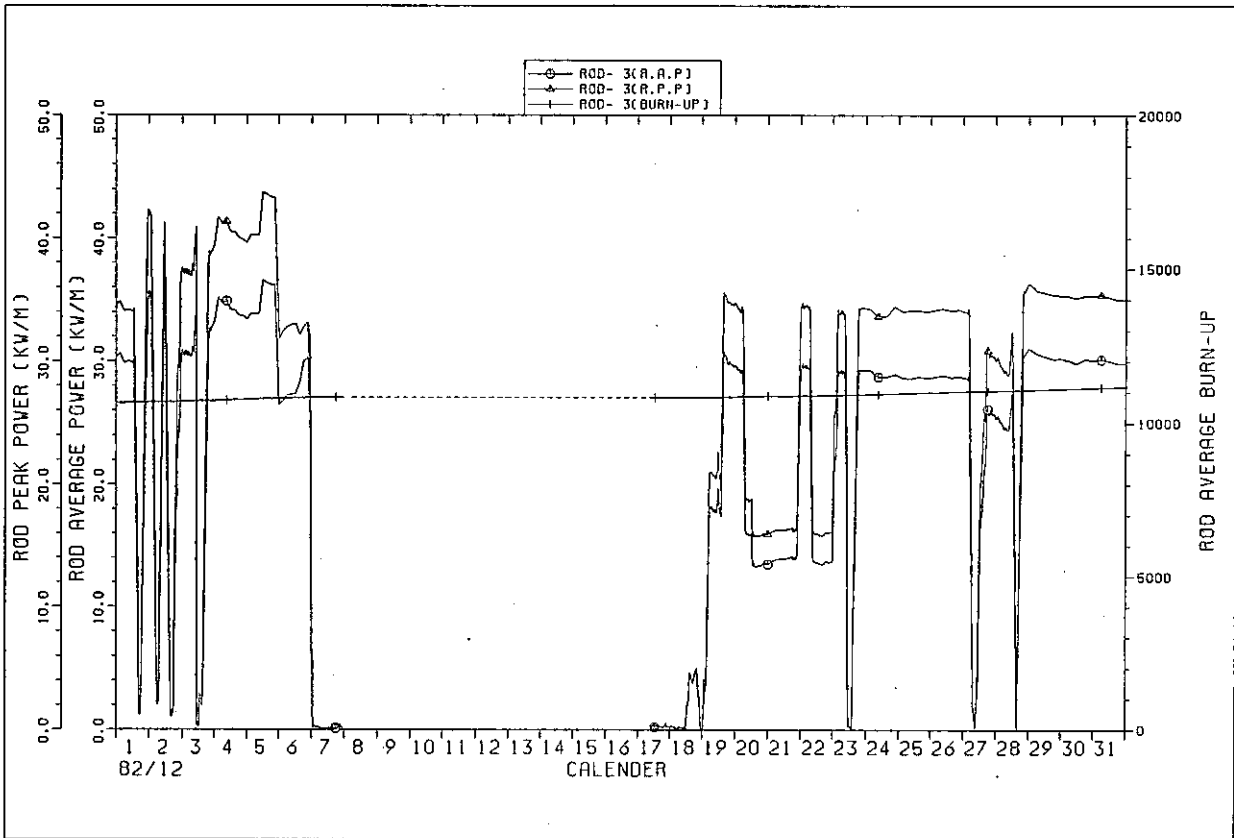

IFA529 ROD POWER HISTORY

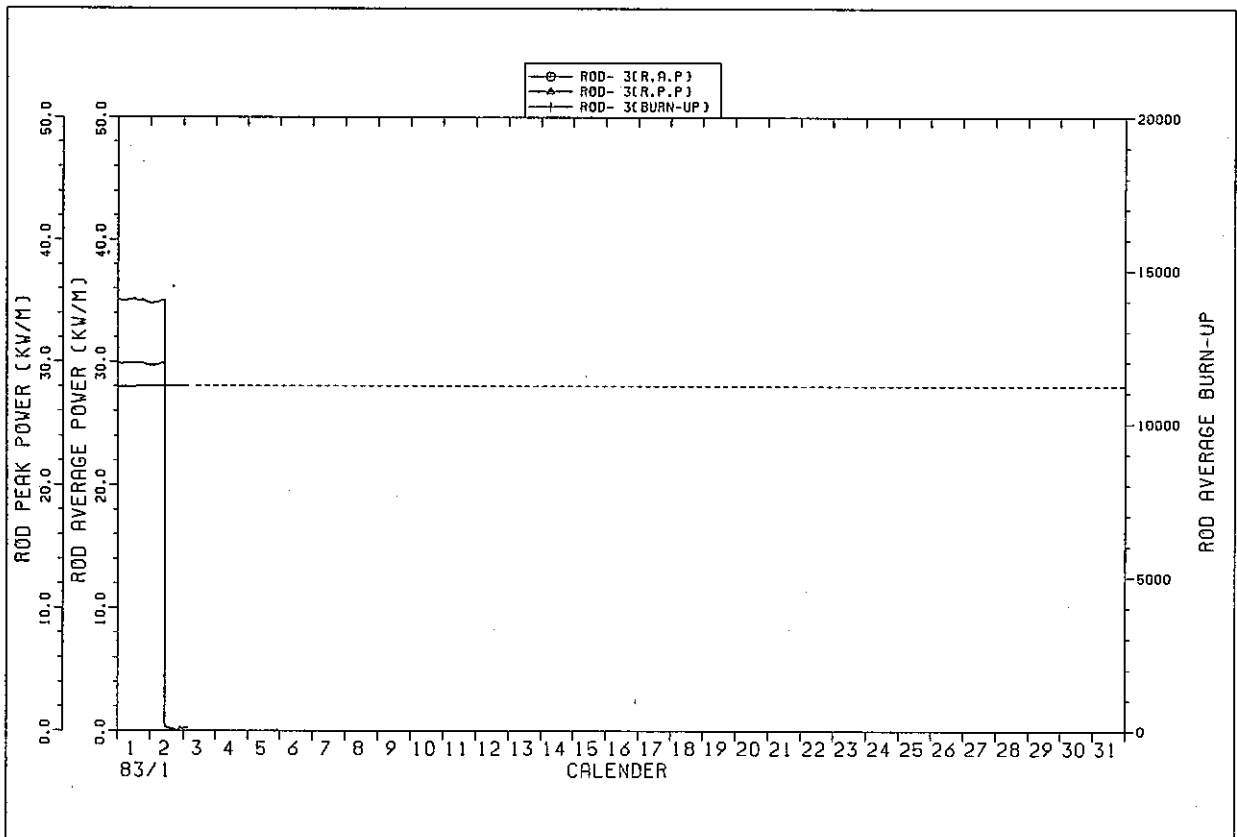

IFA529 ROD POWER HISTORY

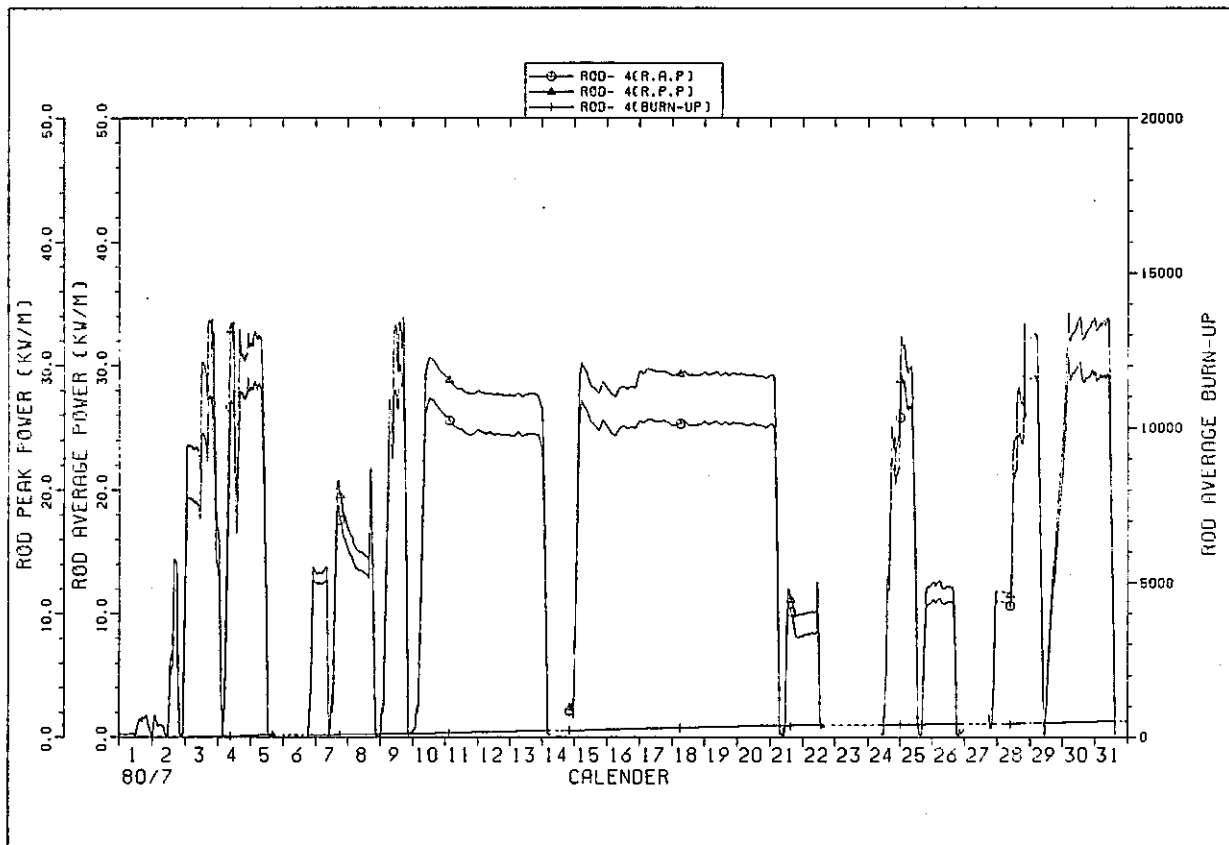

IFA529 ROD POWER HISTORY

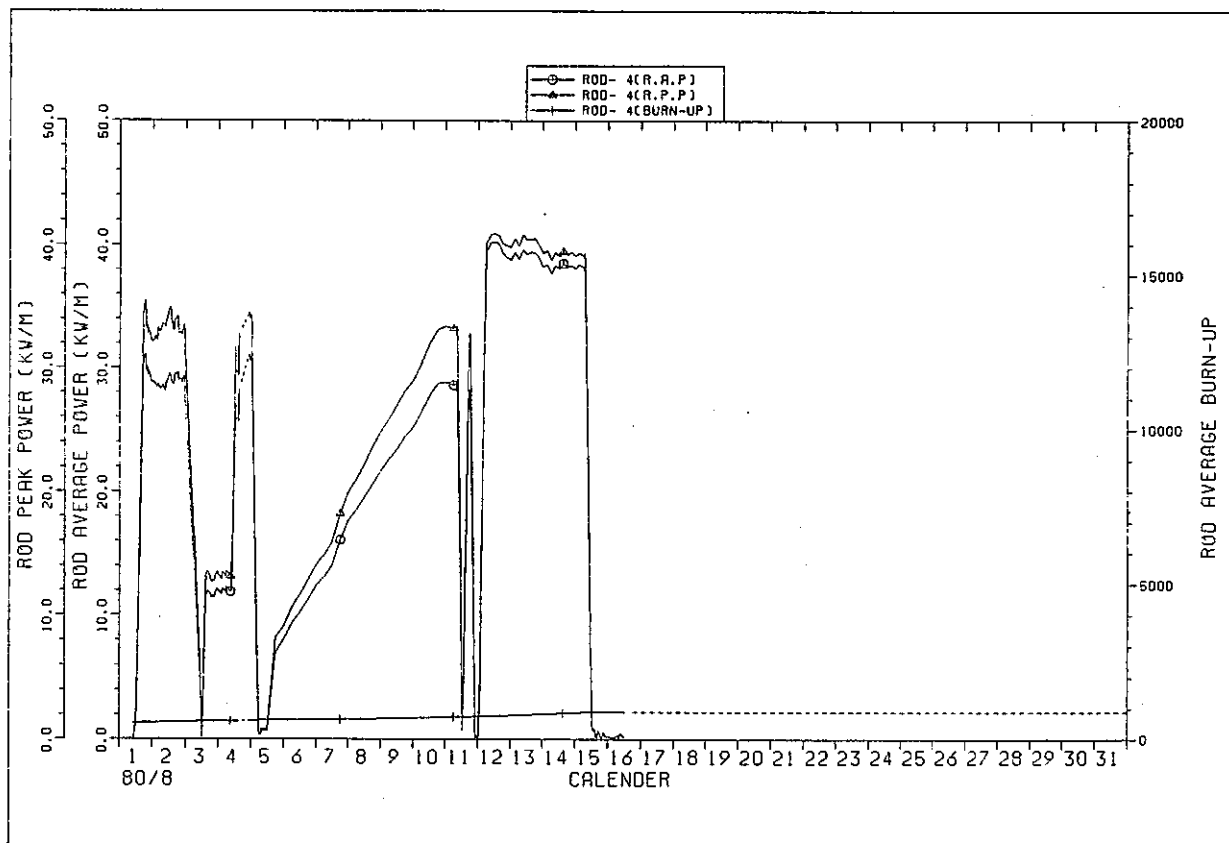

IFA529 ROD POWER HISTORY

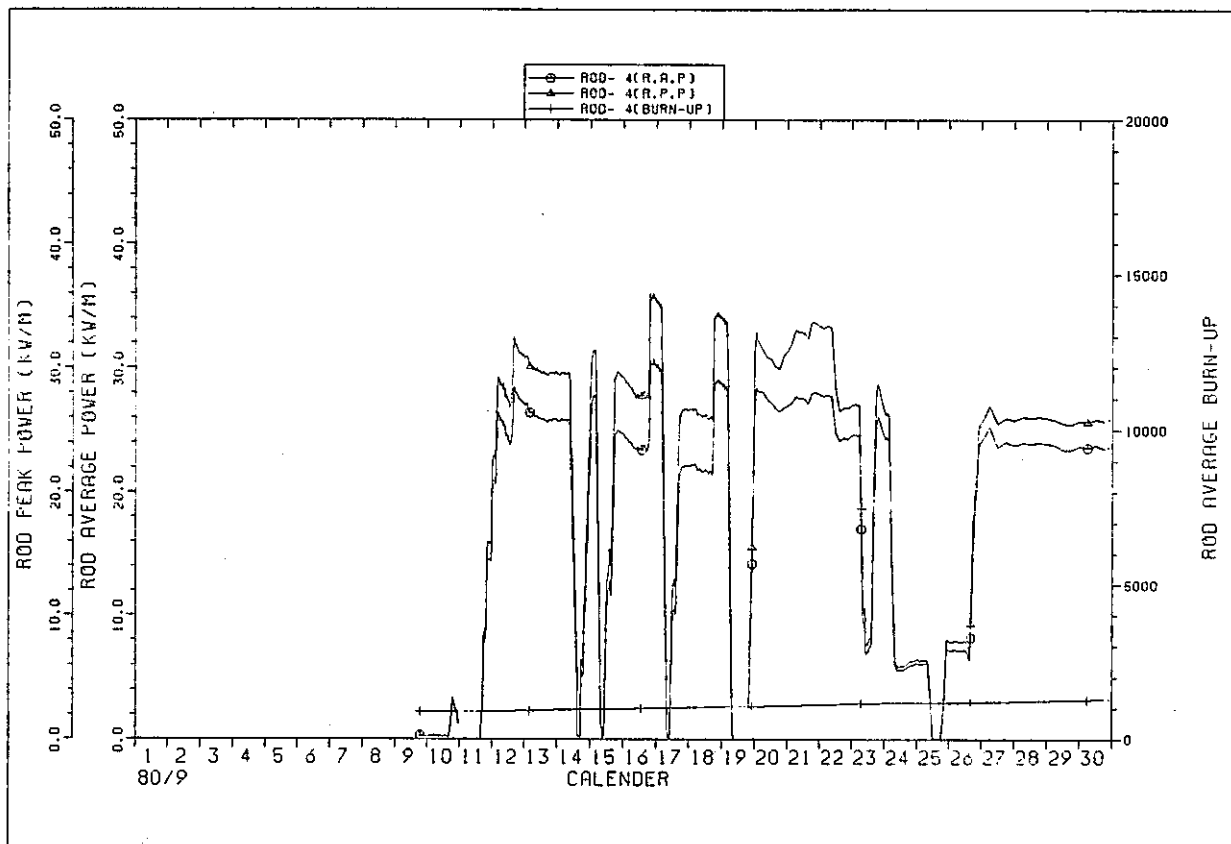

IFA529 ROD POWER HISTORY

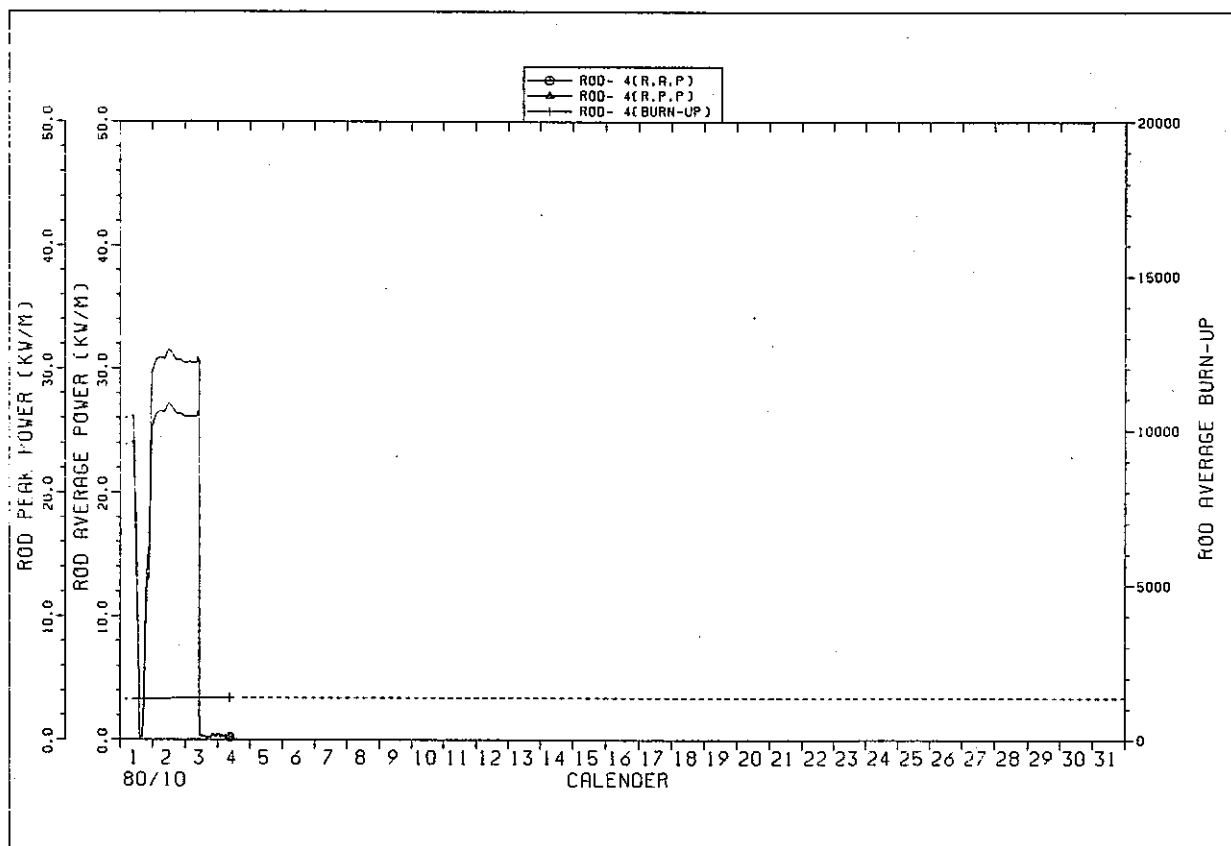

IFA529 ROD POWER HISTORY

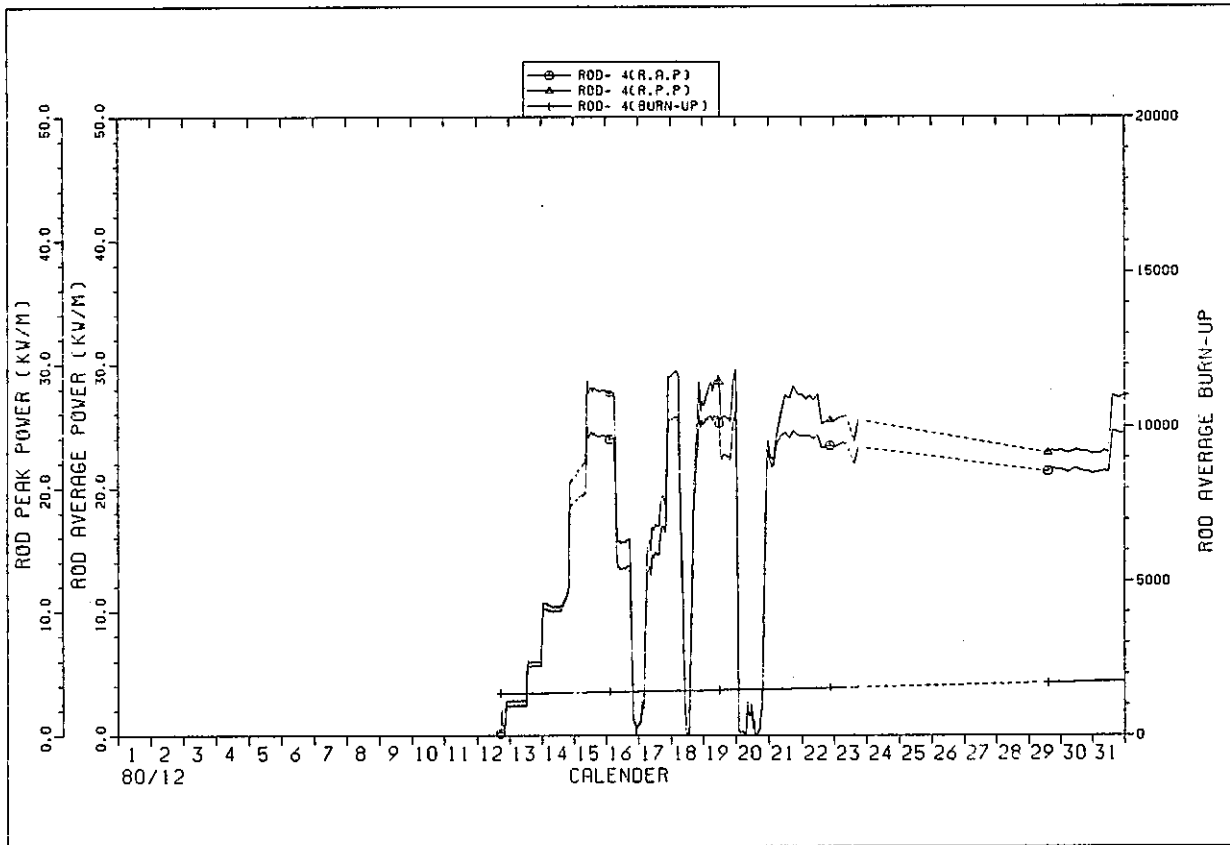

IFA529 ROD POWER HISTORY

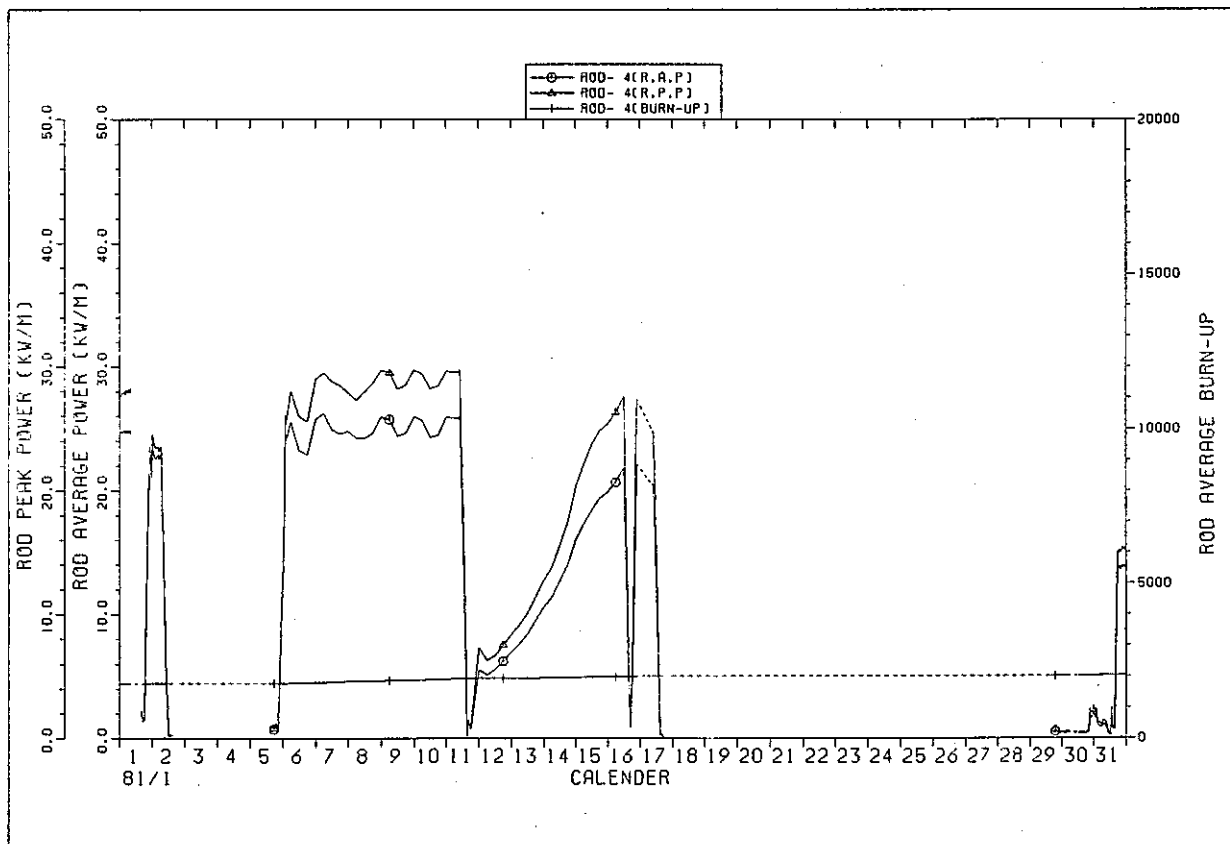

IFA529 ROD POWER HISTORY

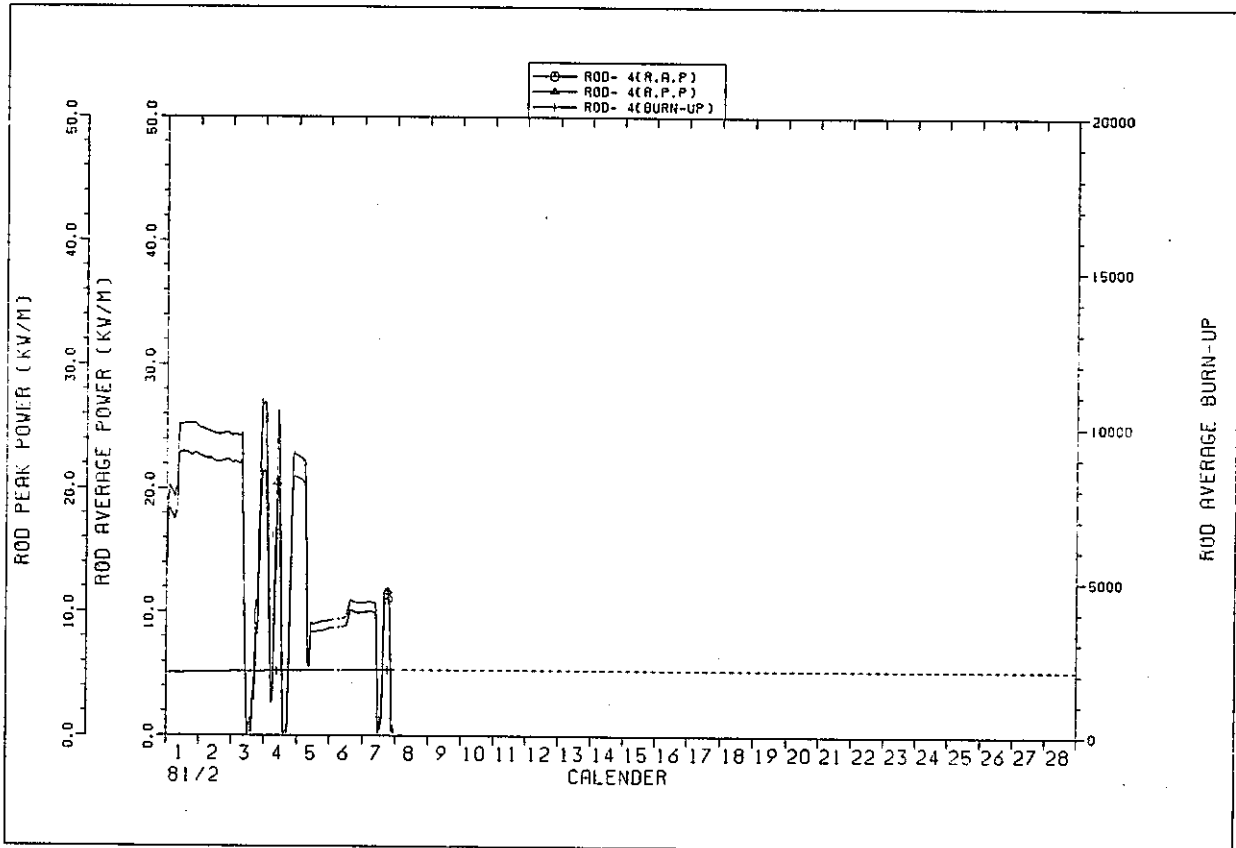

IFA529 ROD POWER HISTORY

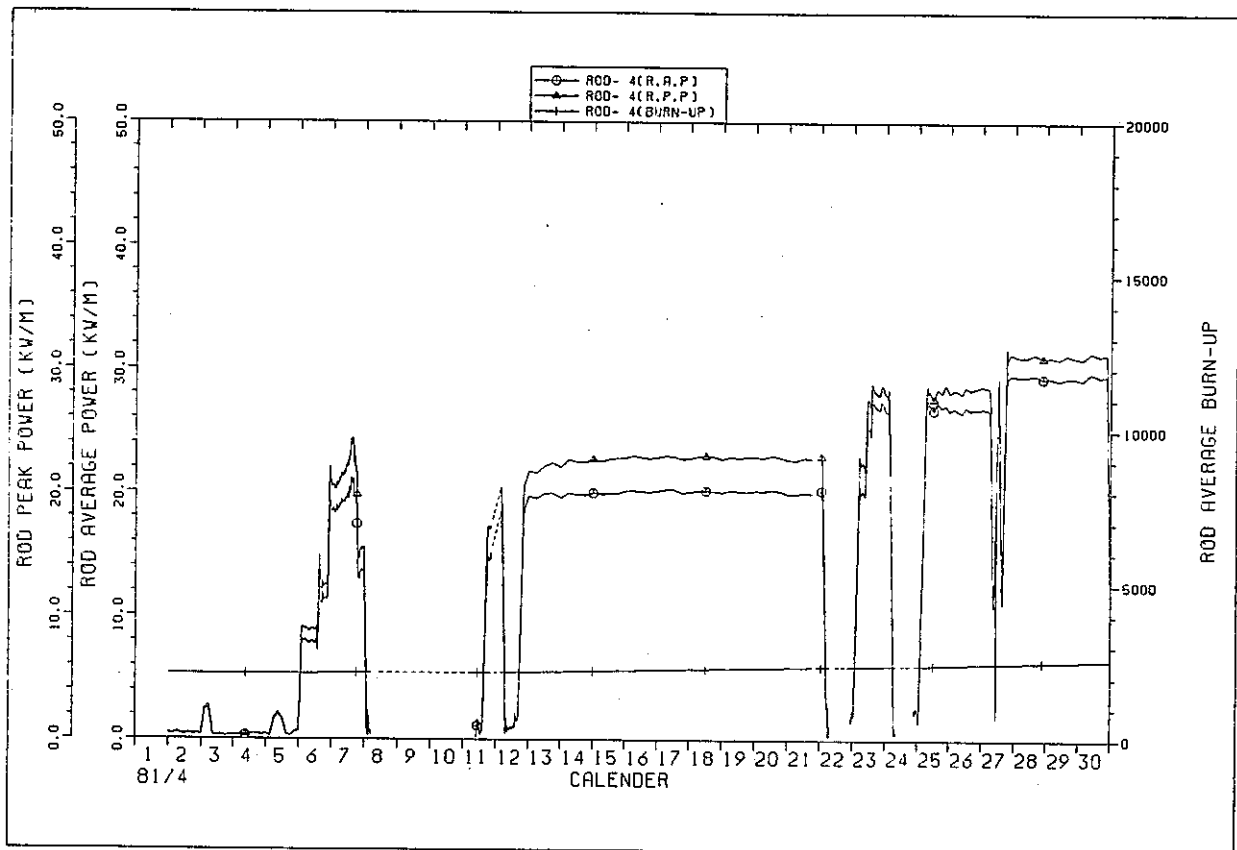

IFA529 ROD POWER HISTORY

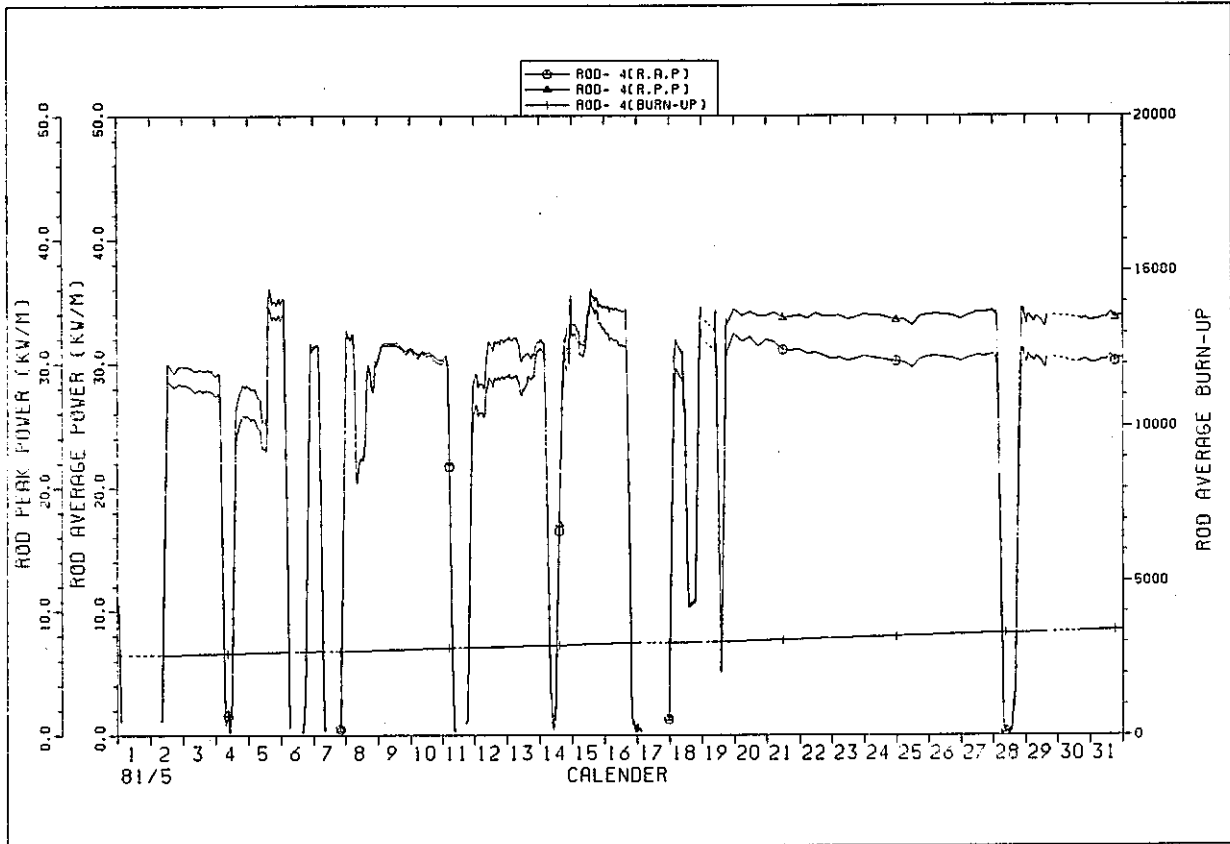

IFA529 ROD POWER HISTORY

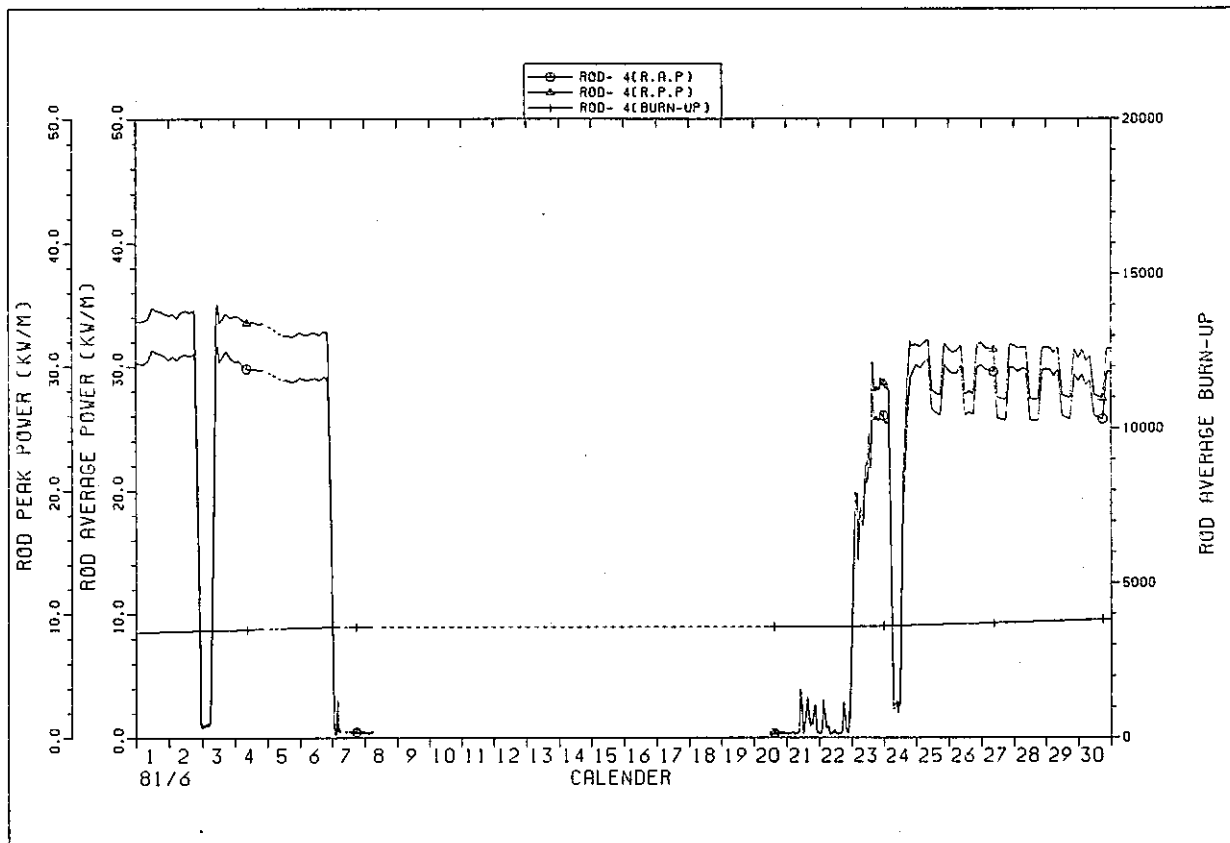

IFA529 ROD POWER HISTORY

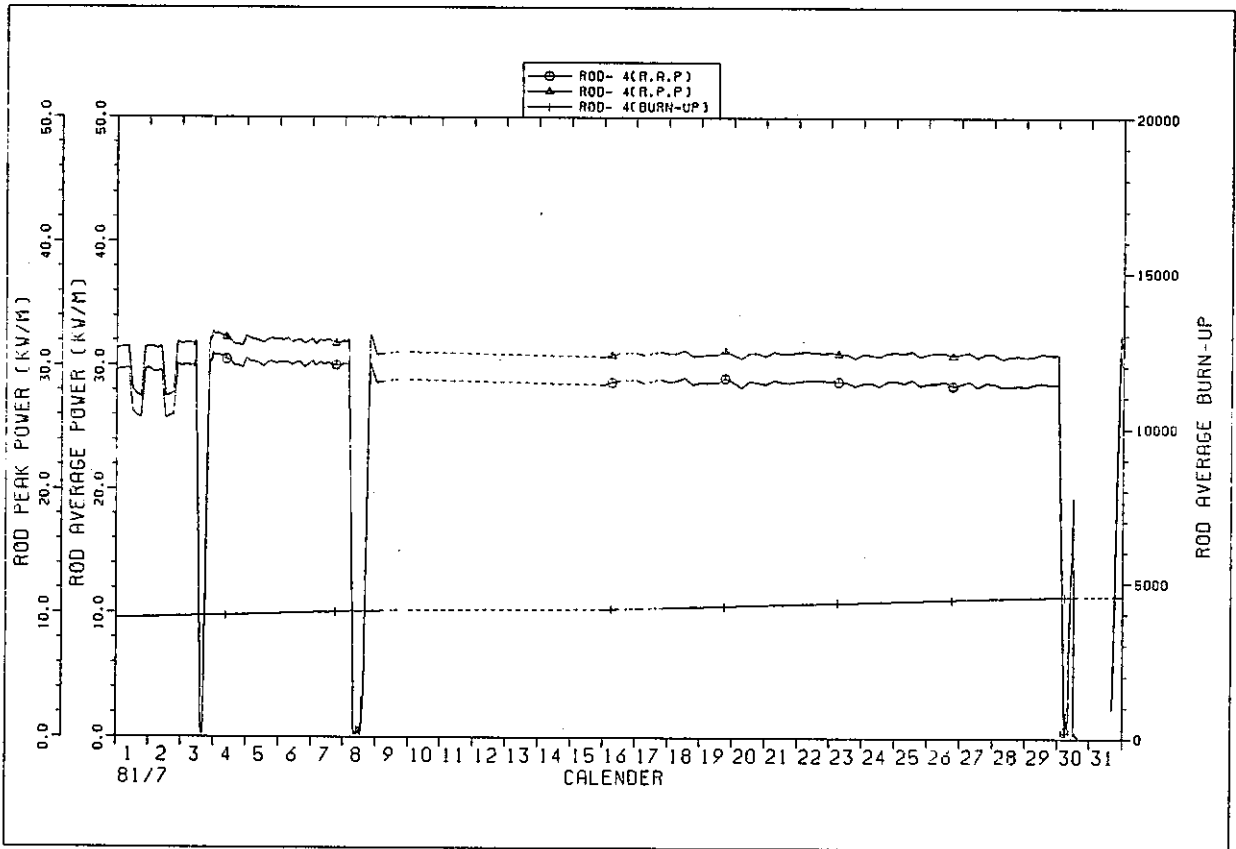

IFA529 ROD POWER HISTORY

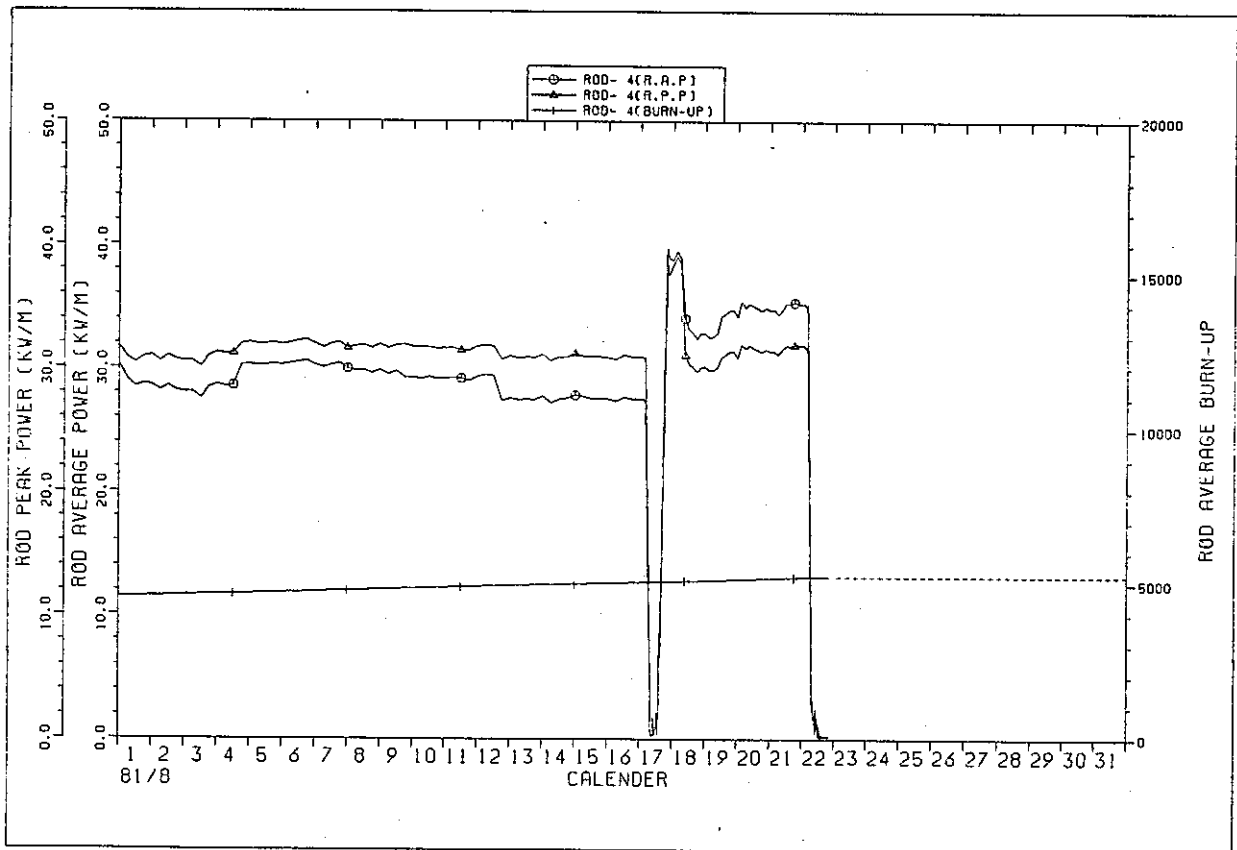

IFA529 ROD POWER HISTORY

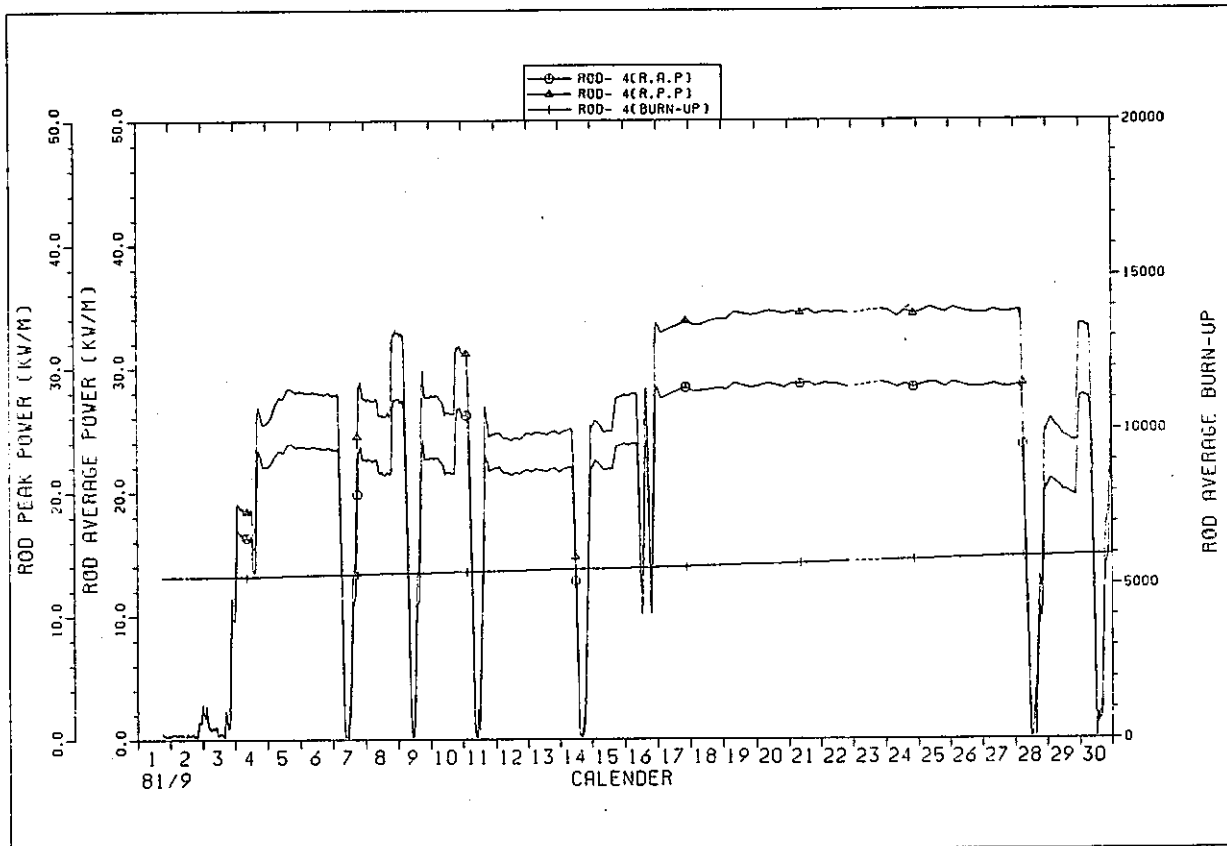

IFA529 ROD POWER HISTORY

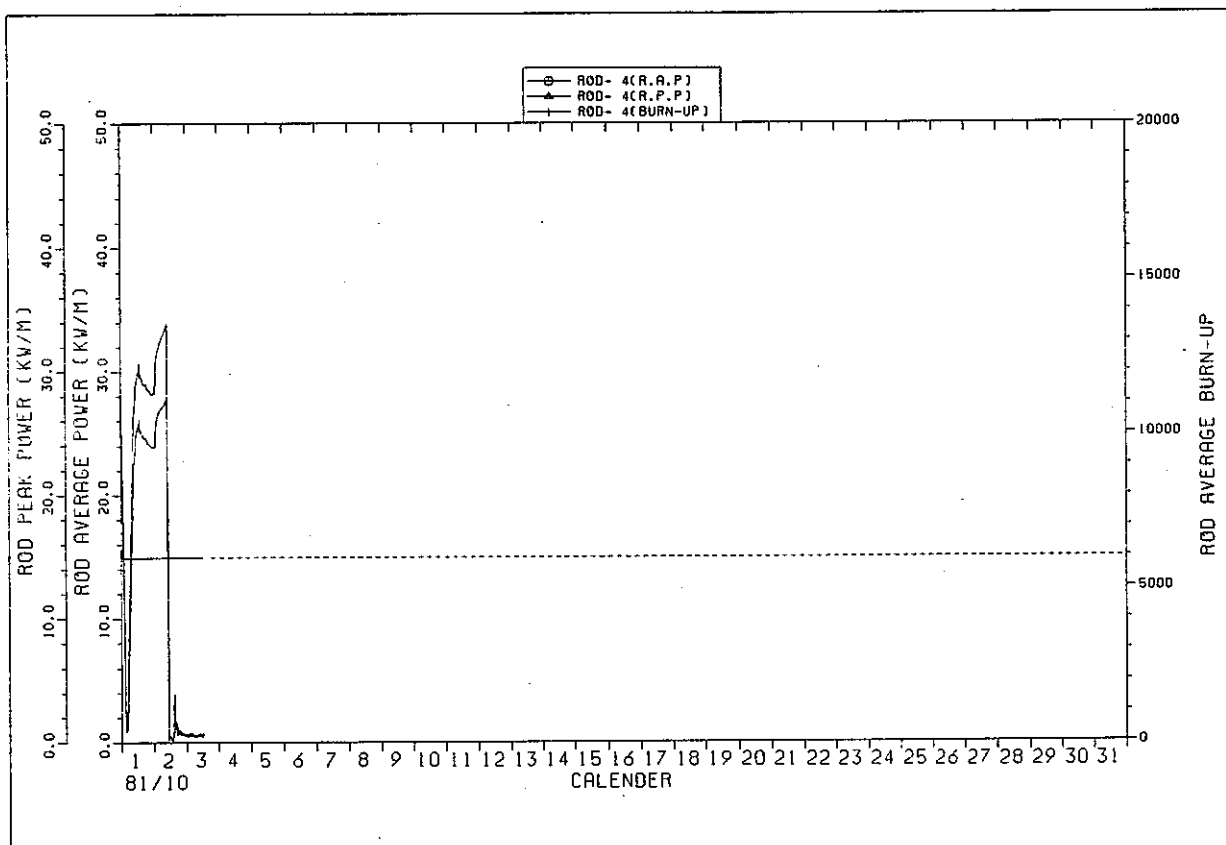

IFA529 ROD POWER HISTORY

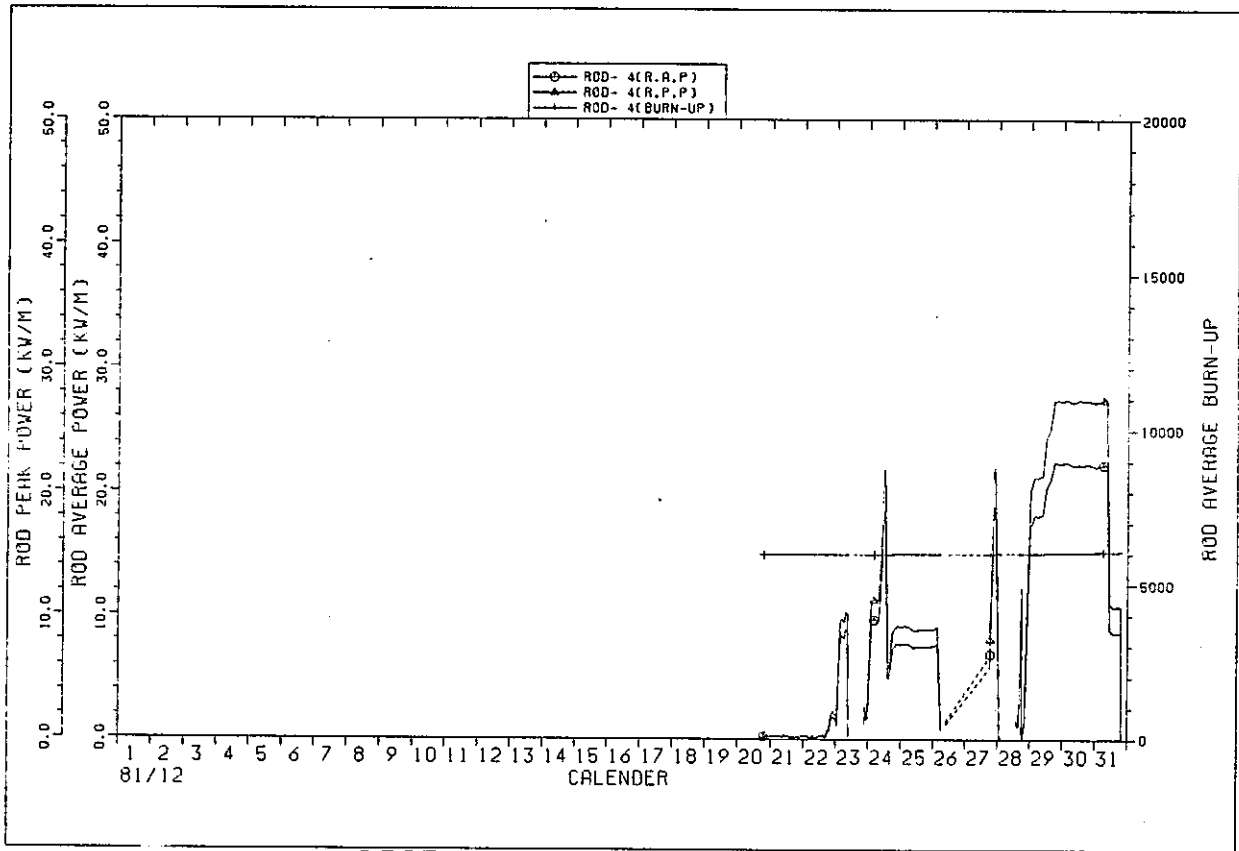

IFA529 ROD POWER HISTORY

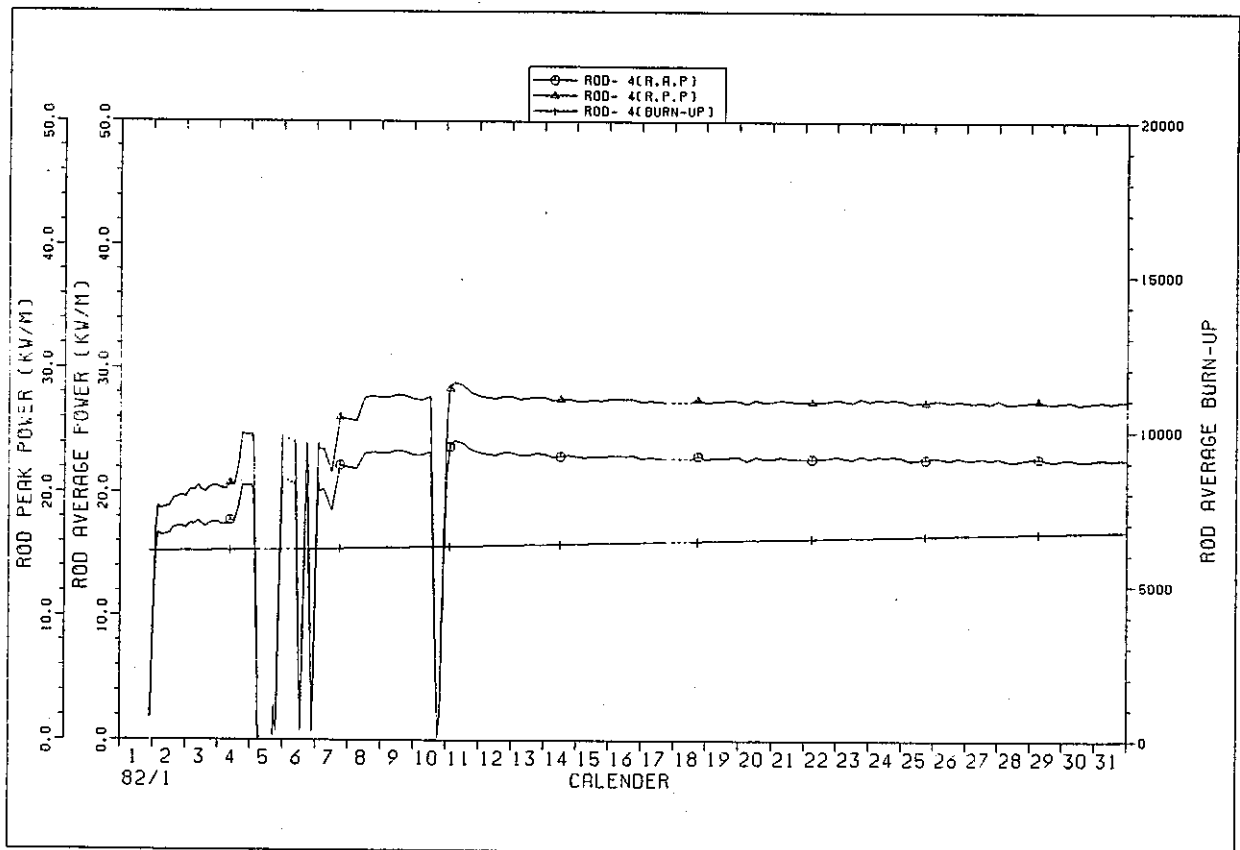

IFA529 ROD POWER HISTORY

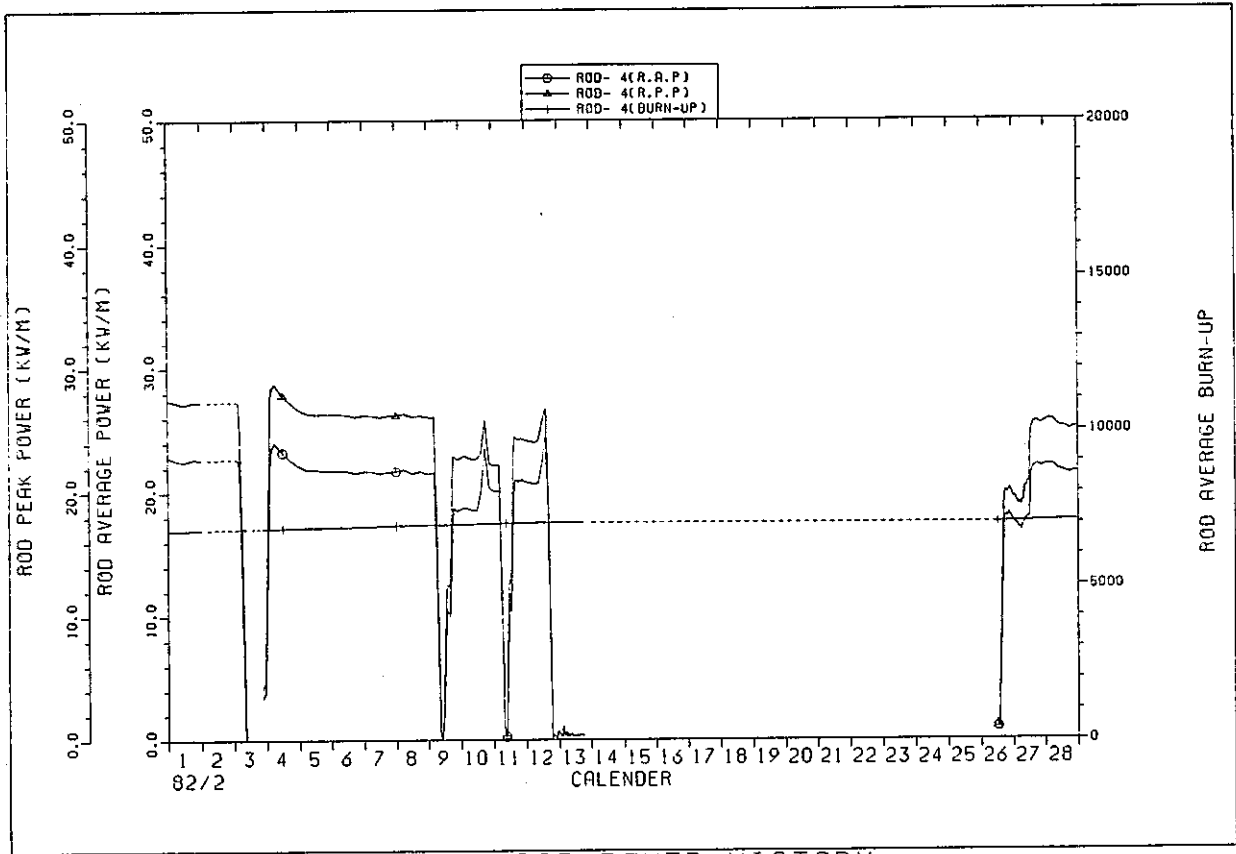

IFA529 ROD POWER HISTORY

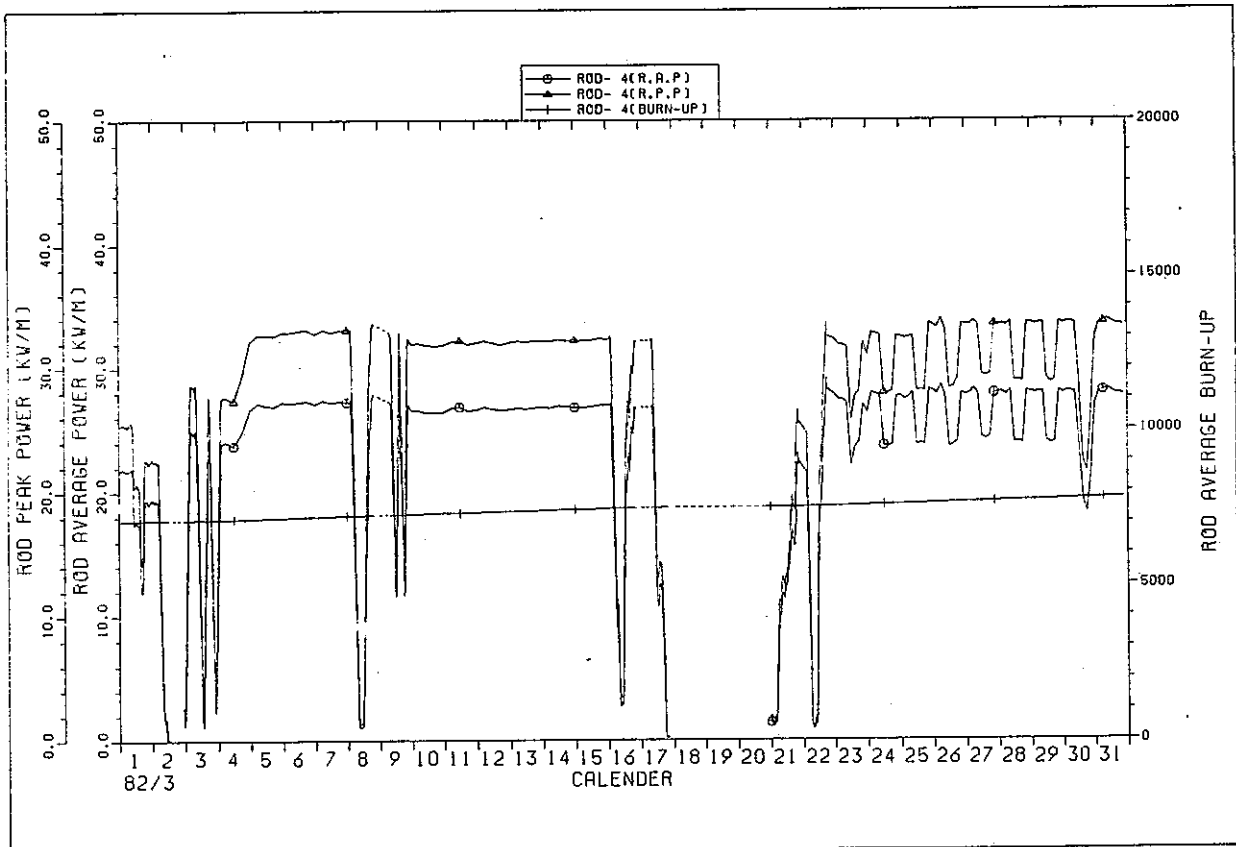

IFA529 ROD POWER HISTORY

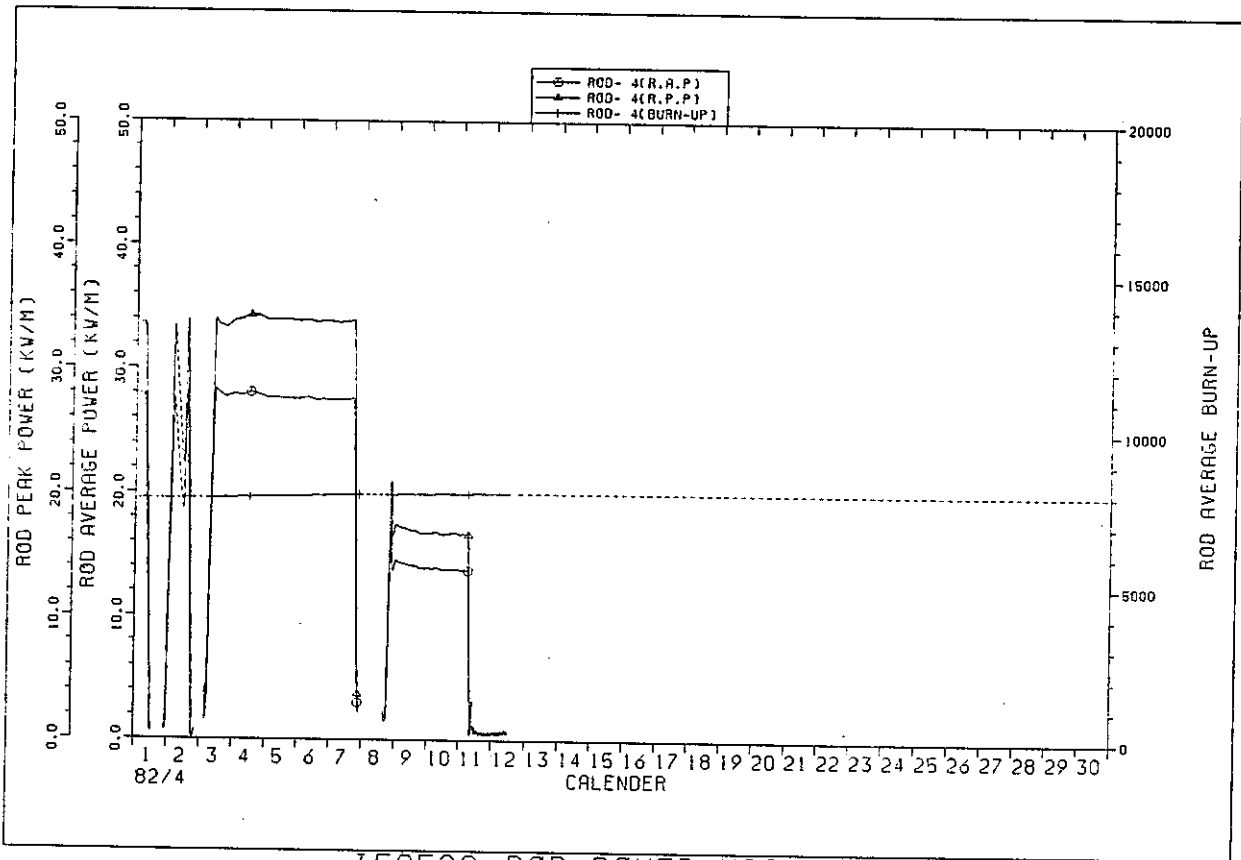

IFA529 ROD POWER HISTORY

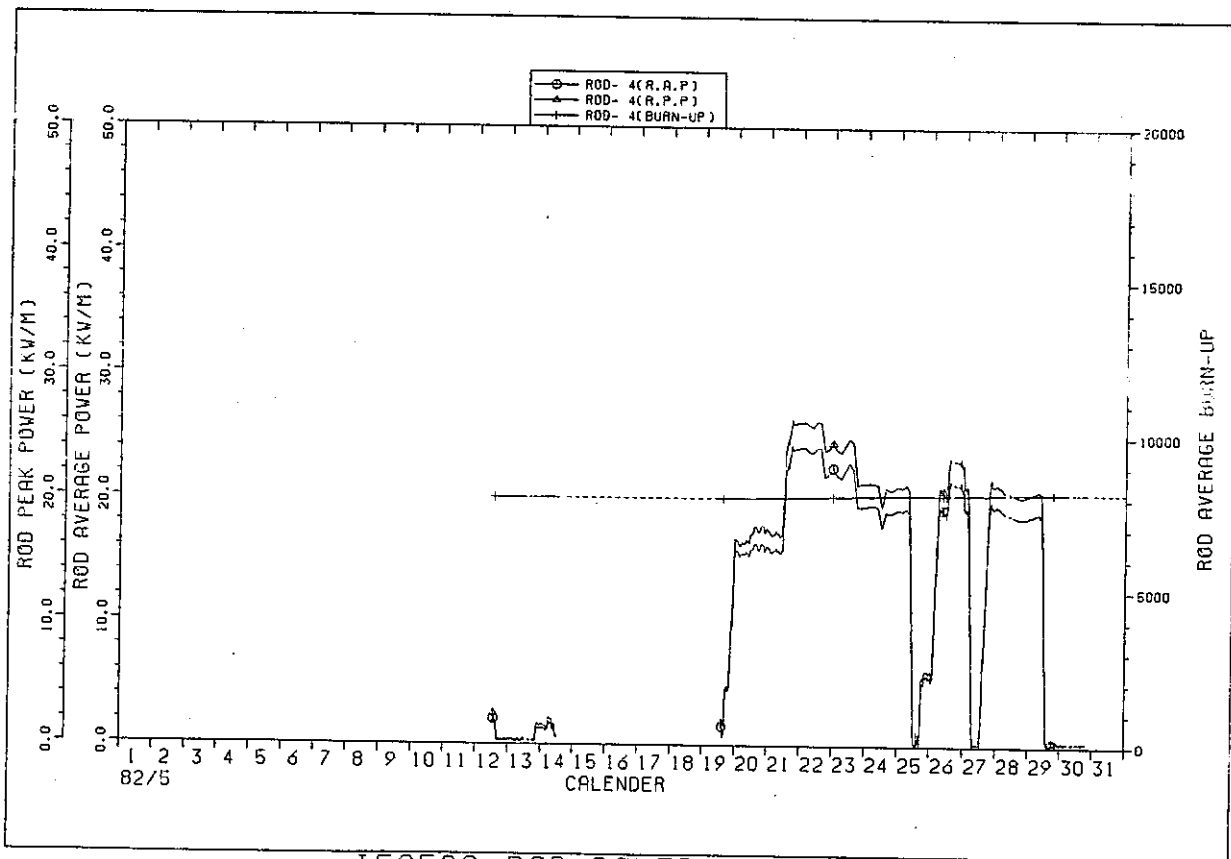

IFA529 ROD POWER HISTORY

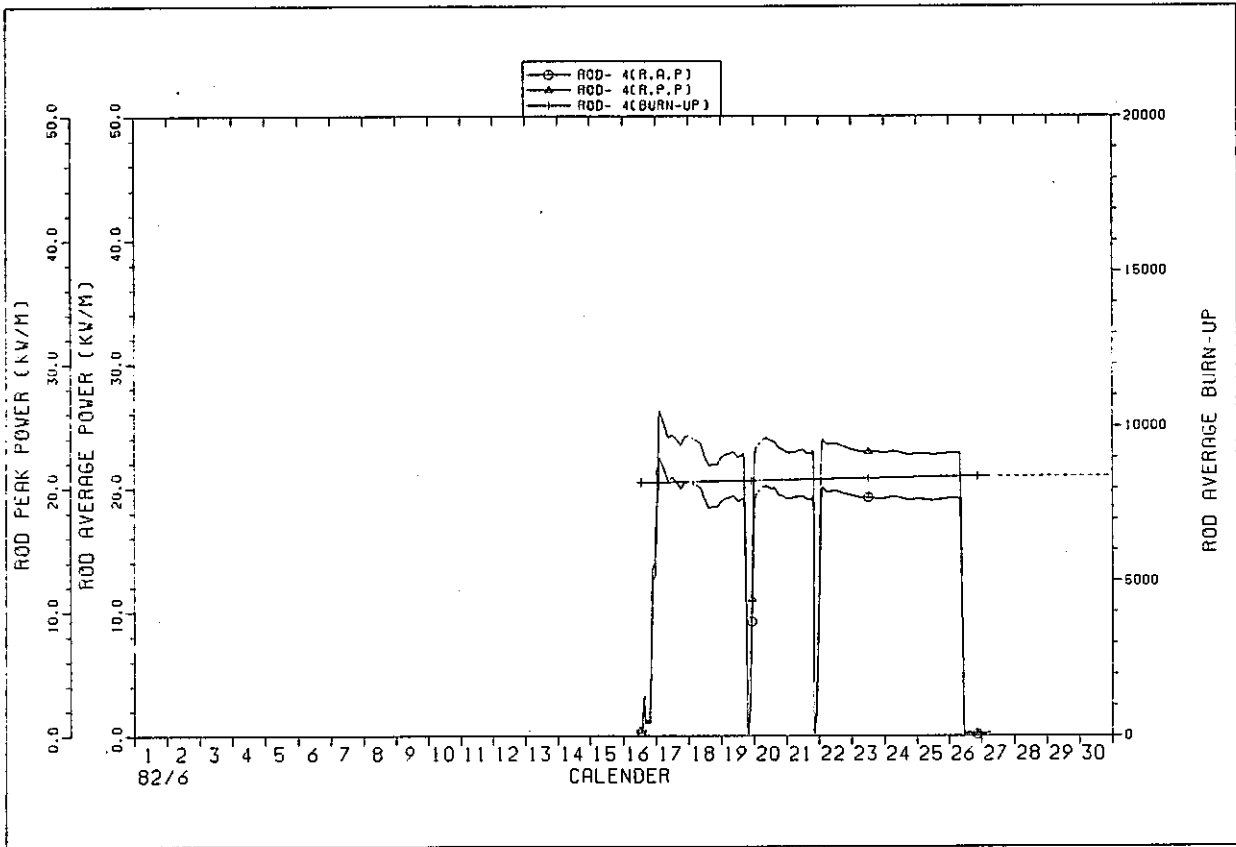

IFA529 ROD POWER HISTORY

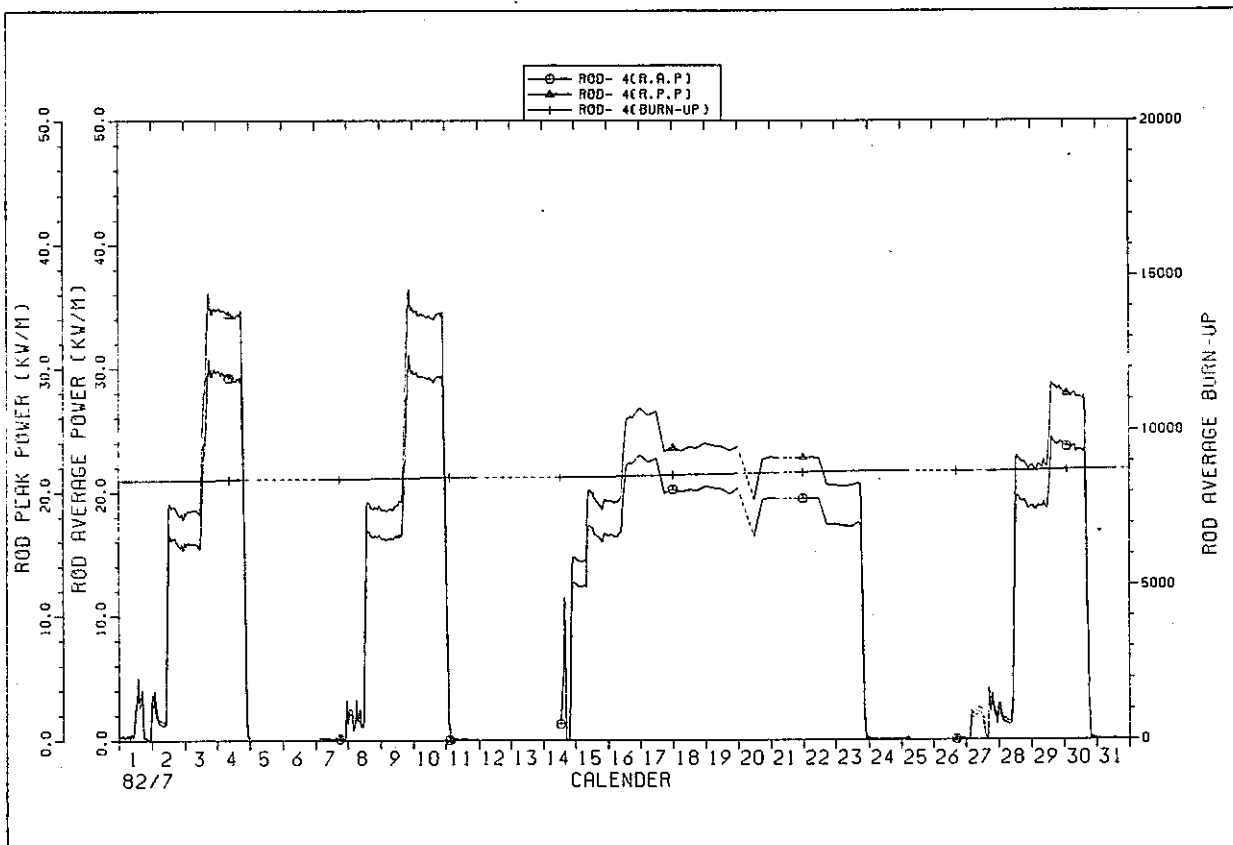

IFA529 ROD POWER HISTORY

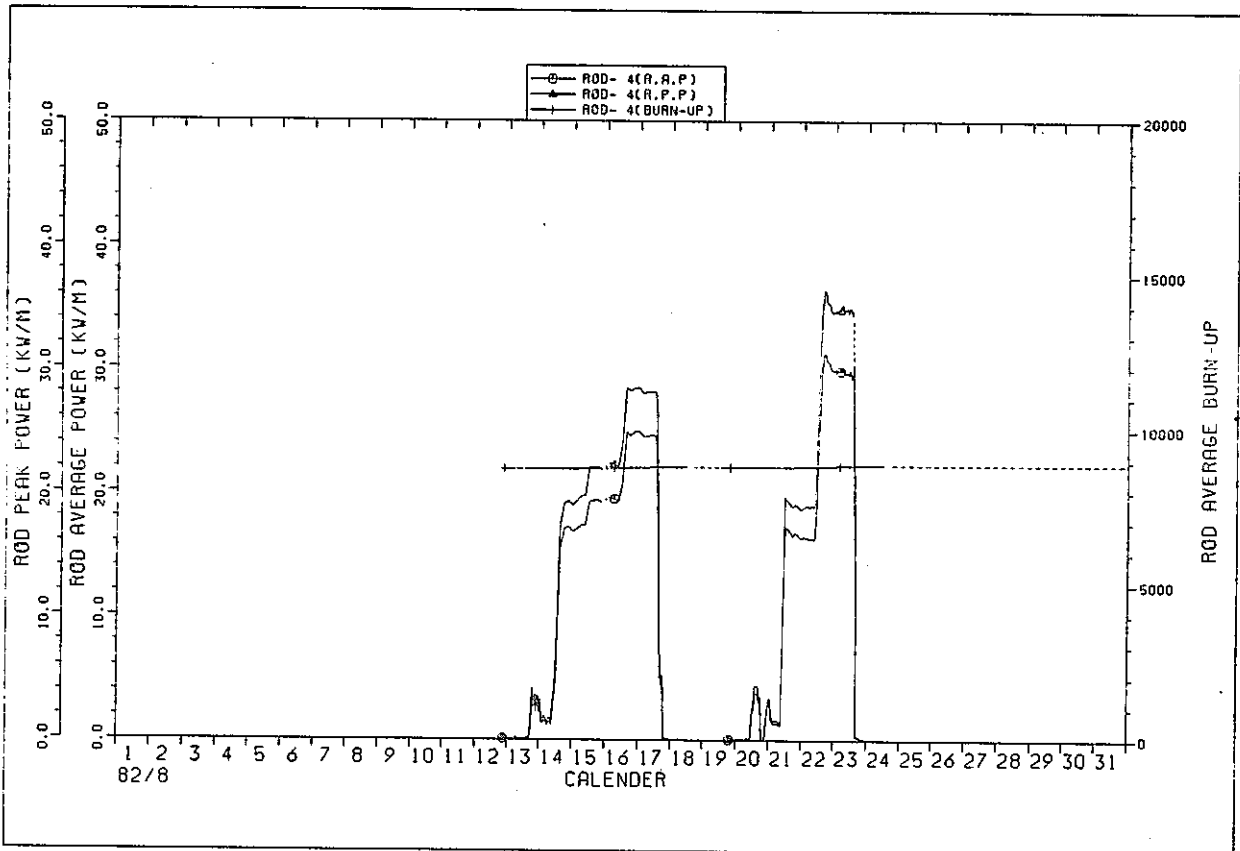

IFA529 ROD POWER HISTORY

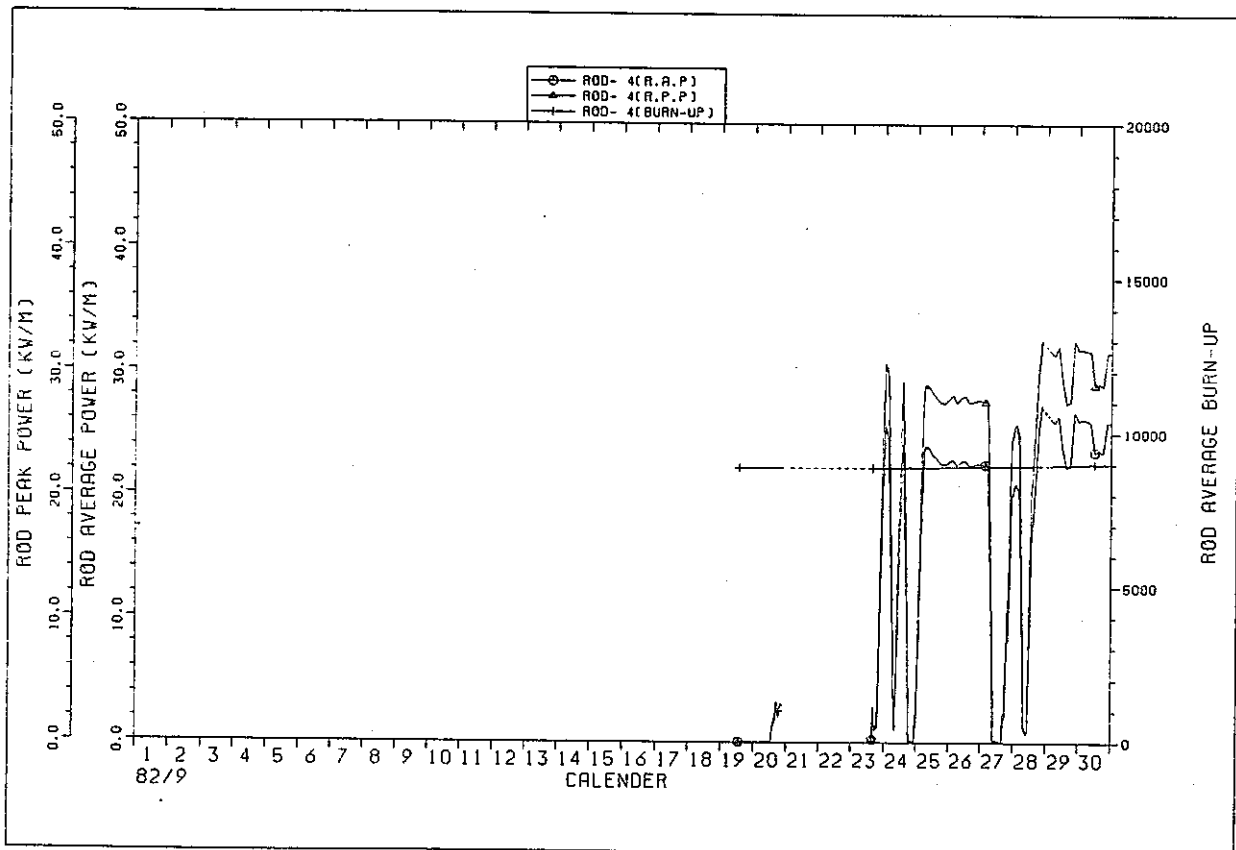

IFA529 ROD POWER HISTORY

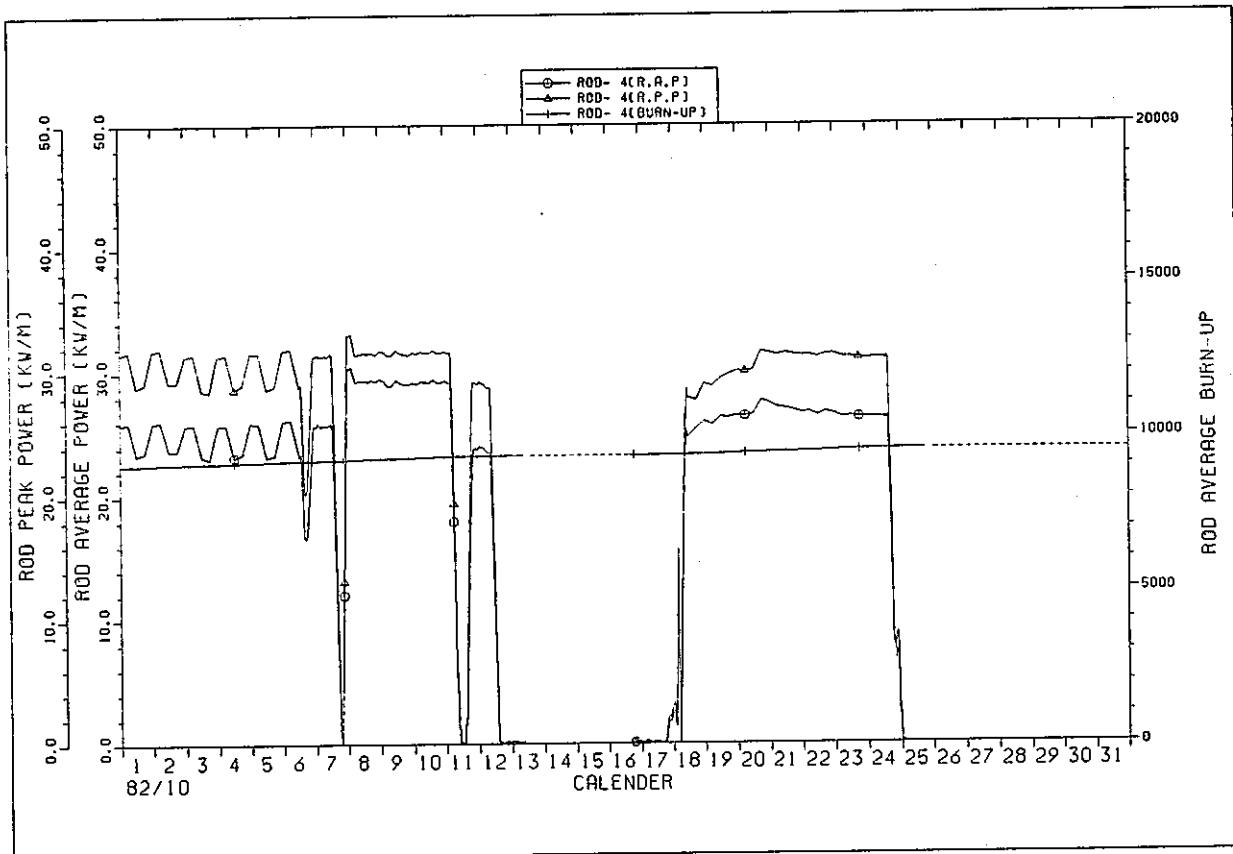

IFA529 ROD POWER HISTORY

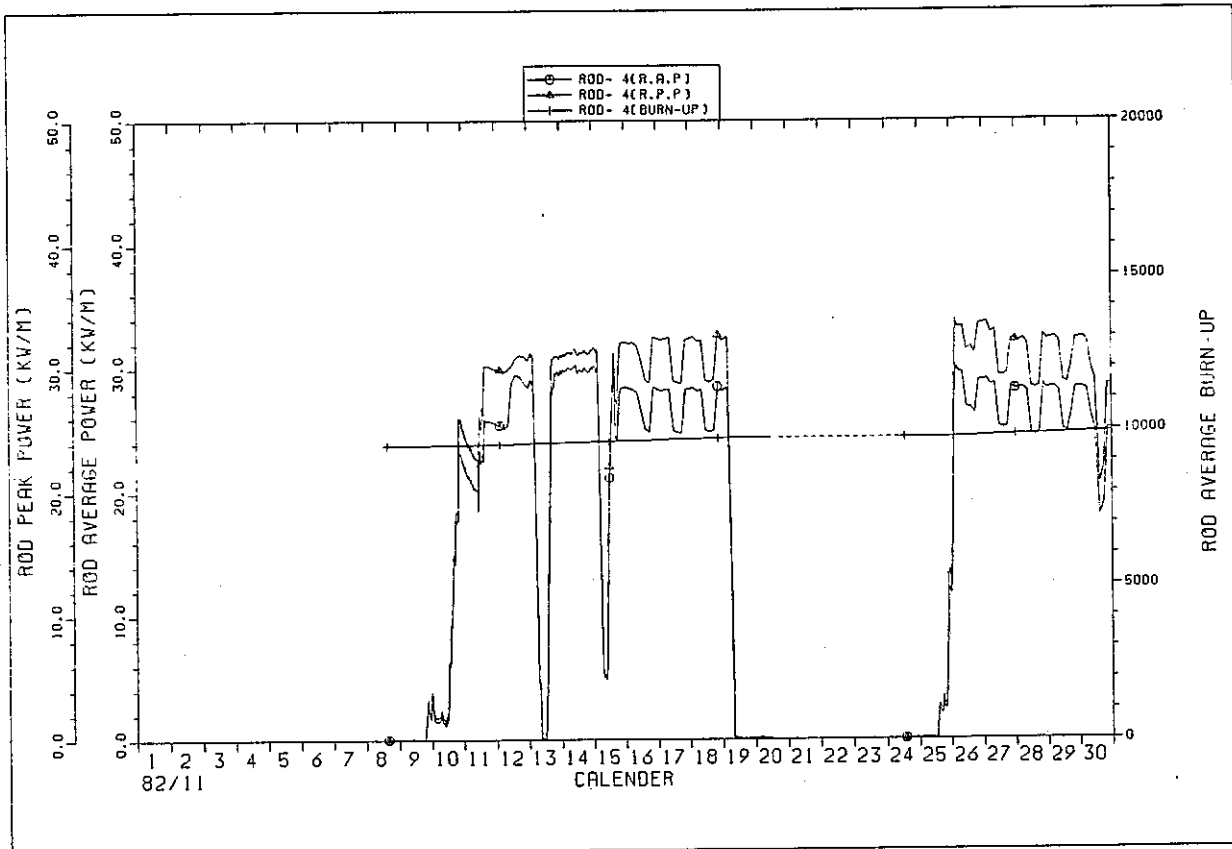

IFA529 ROD POWER HISTORY

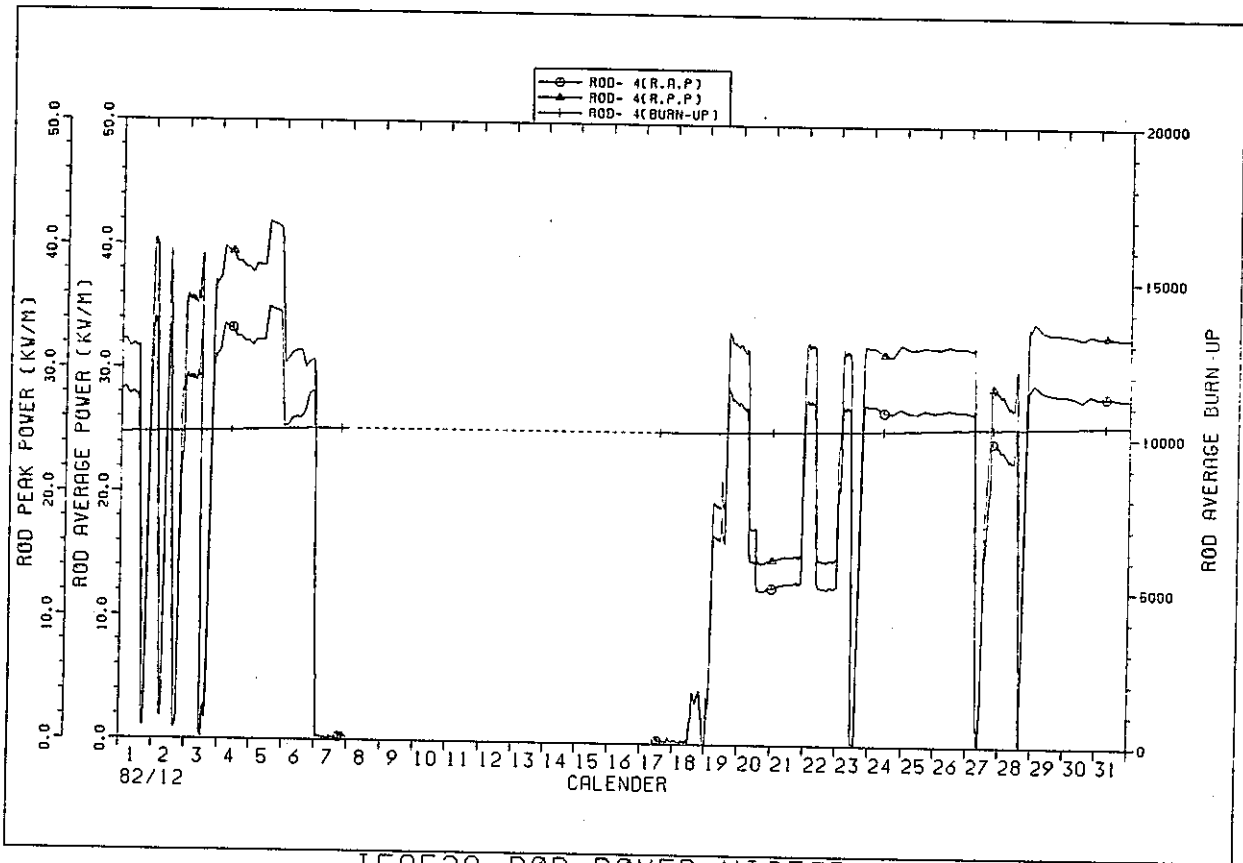

IFA529 ROD POWER HISTORY

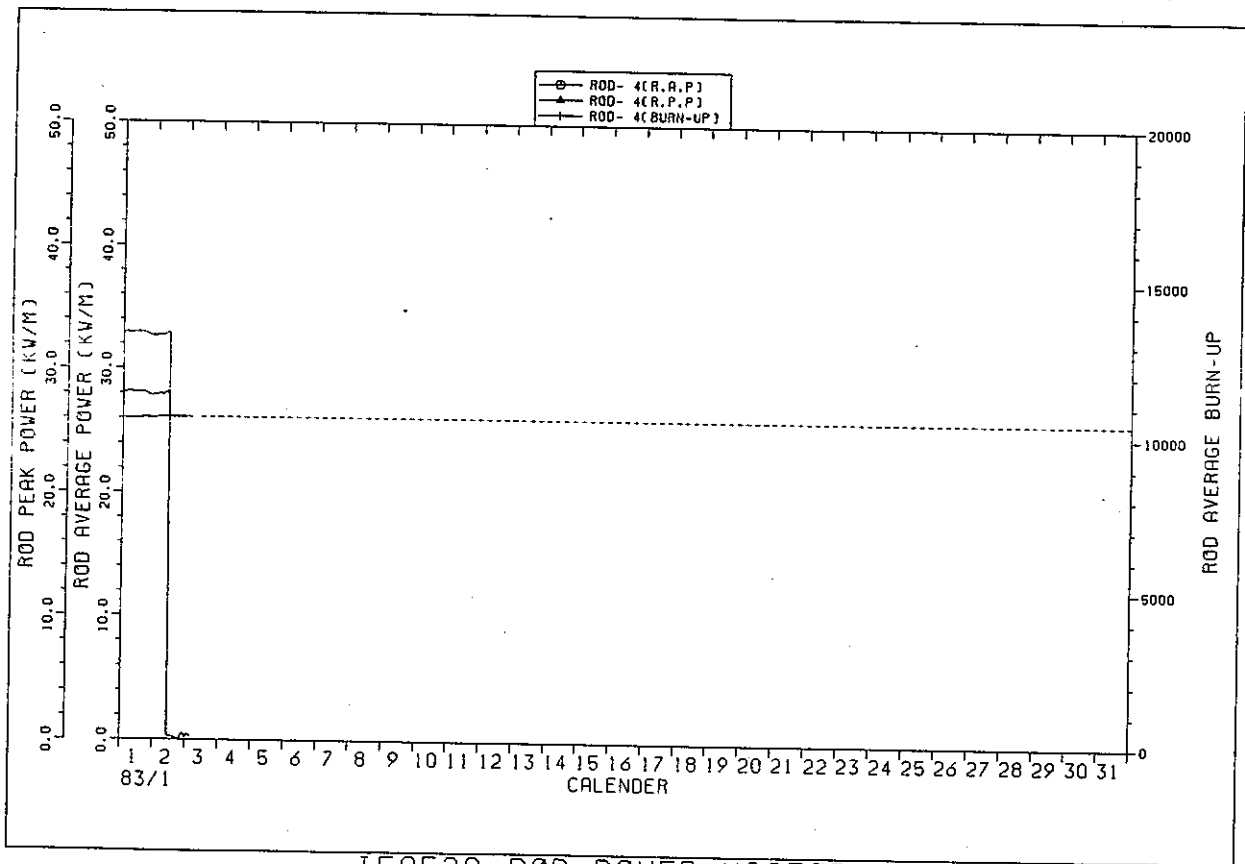

IFA529 ROD POWER HISTORY

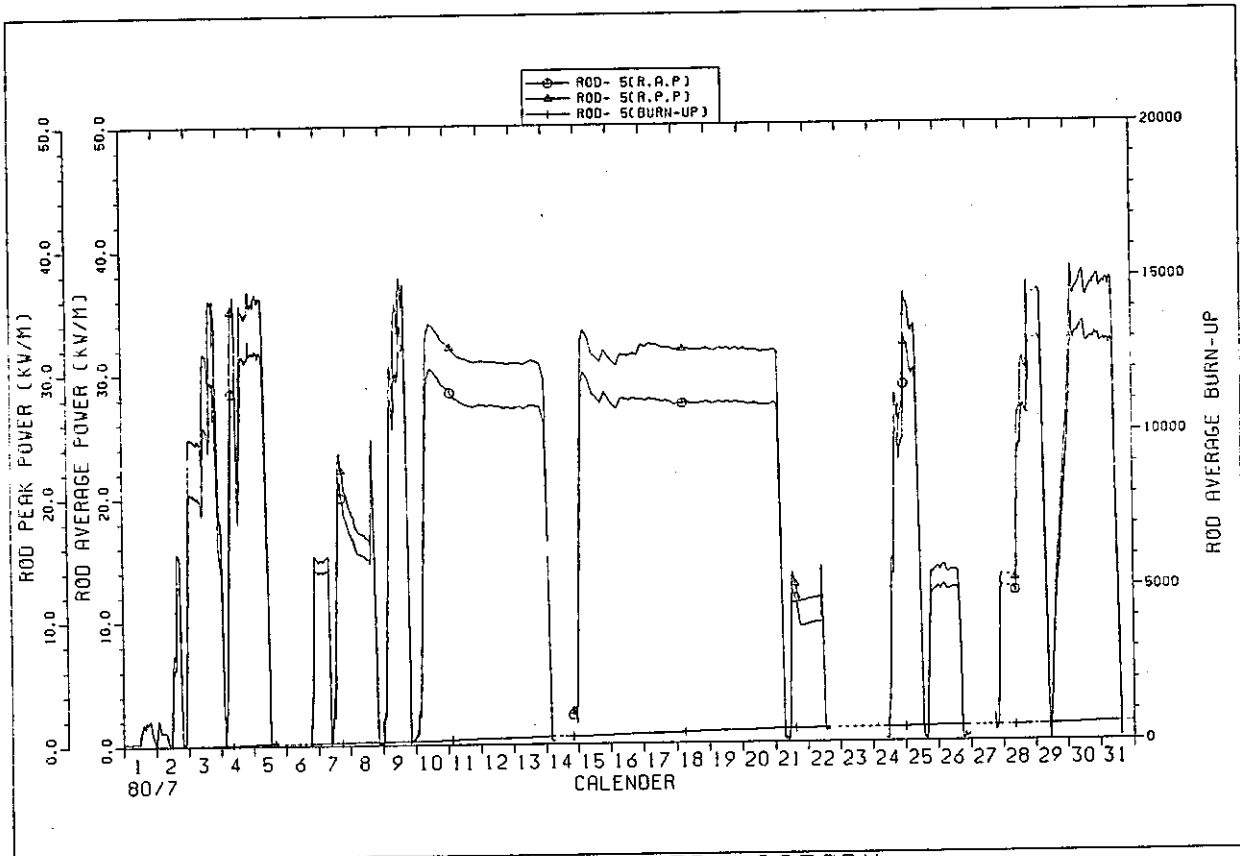

IFA529 ROD POWER HISTORY

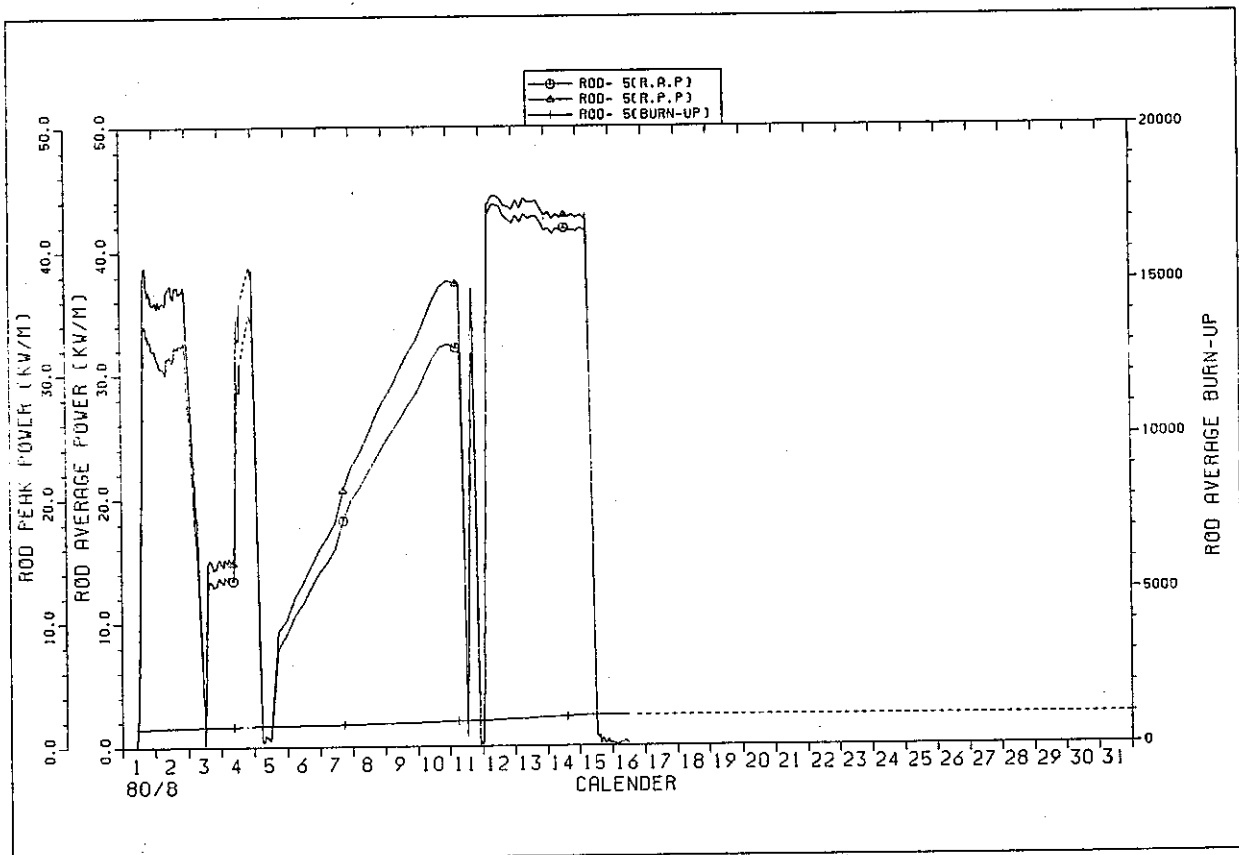

IFA529 ROD POWER HISTORY

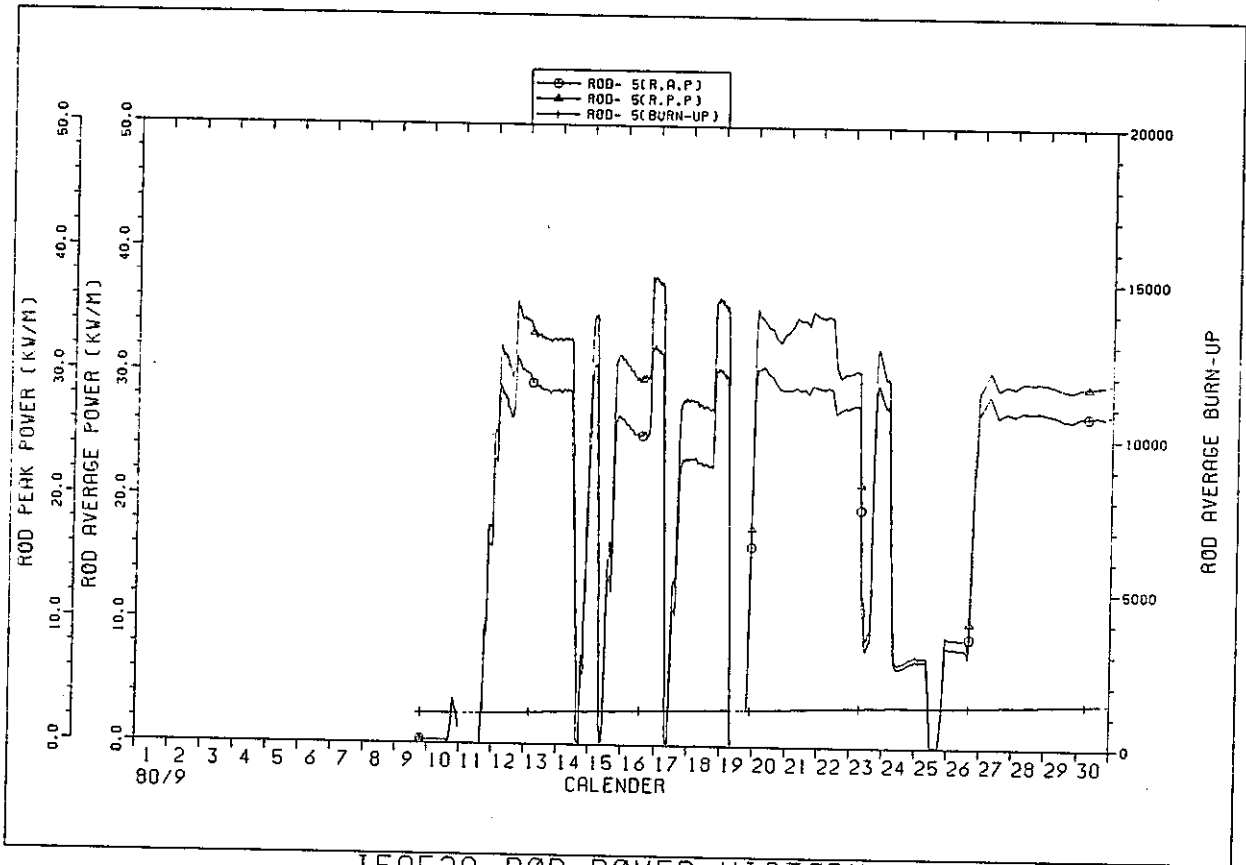

IFA529 ROD POWER HISTORY

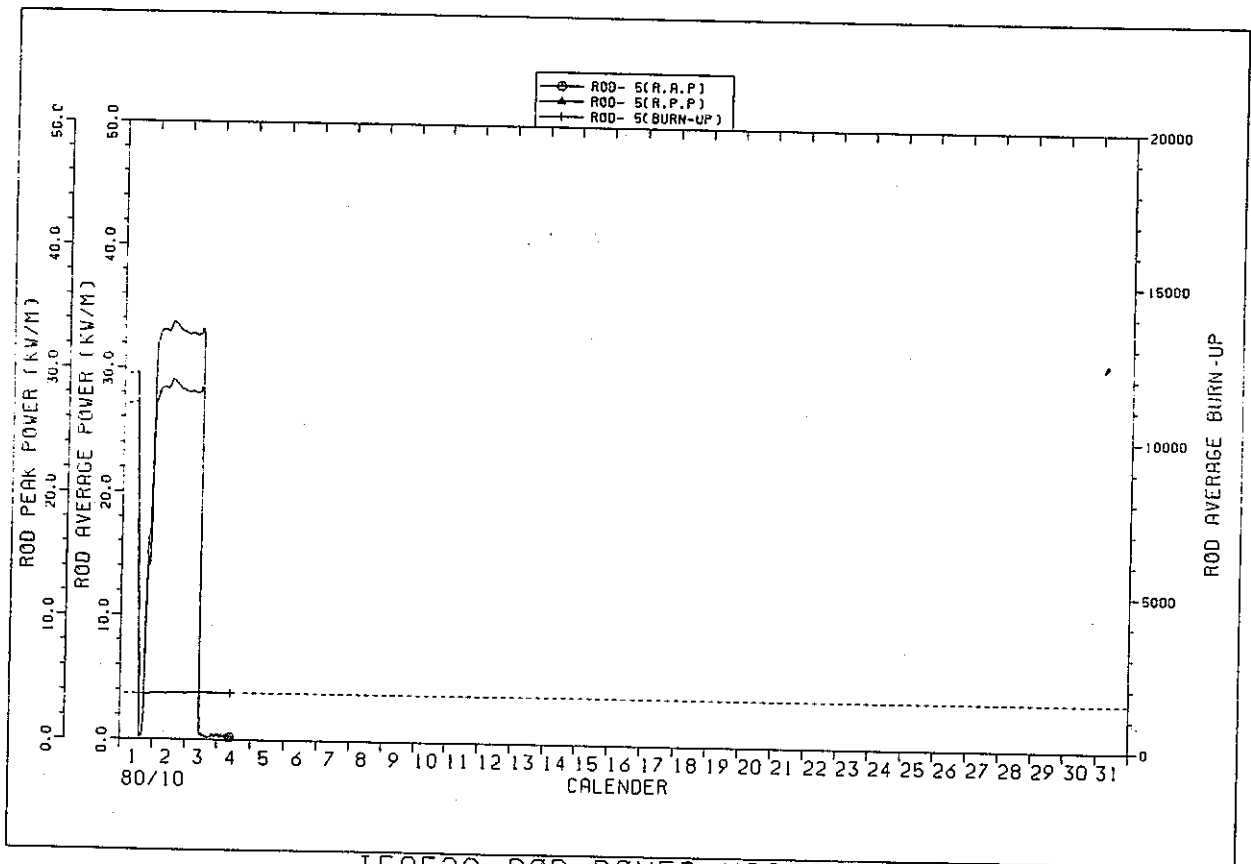

IFA529 ROD POWER HISTORY

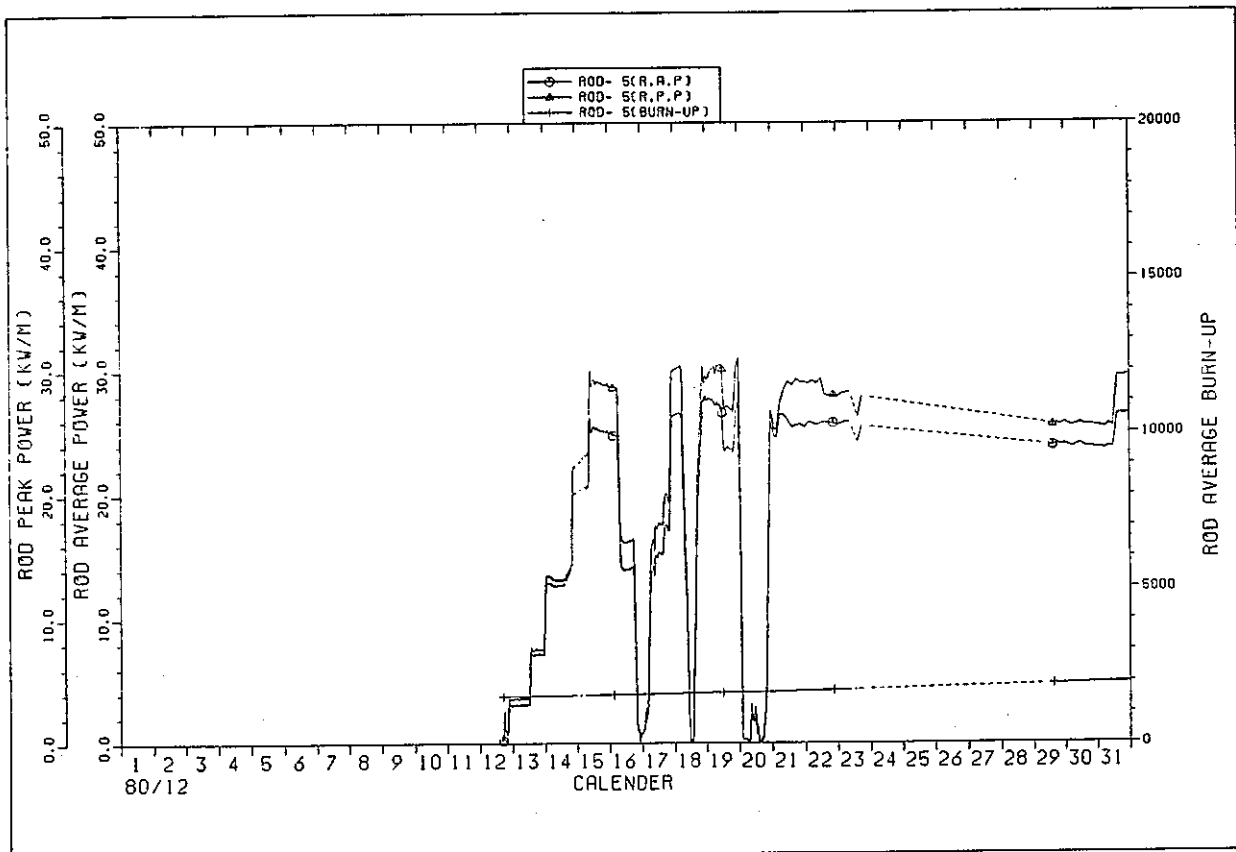

IFA529 ROD POWER HISTORY

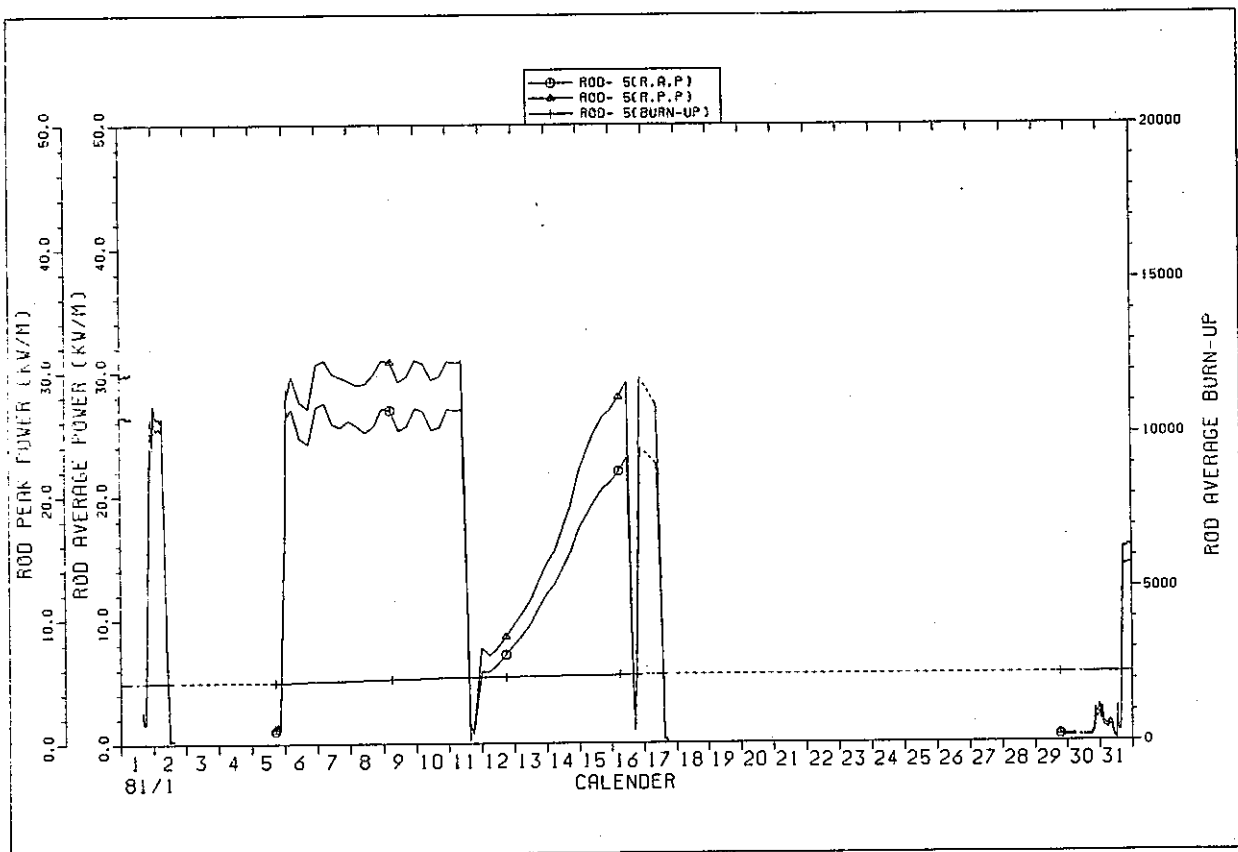

IFA529 ROD POWER HISTORY

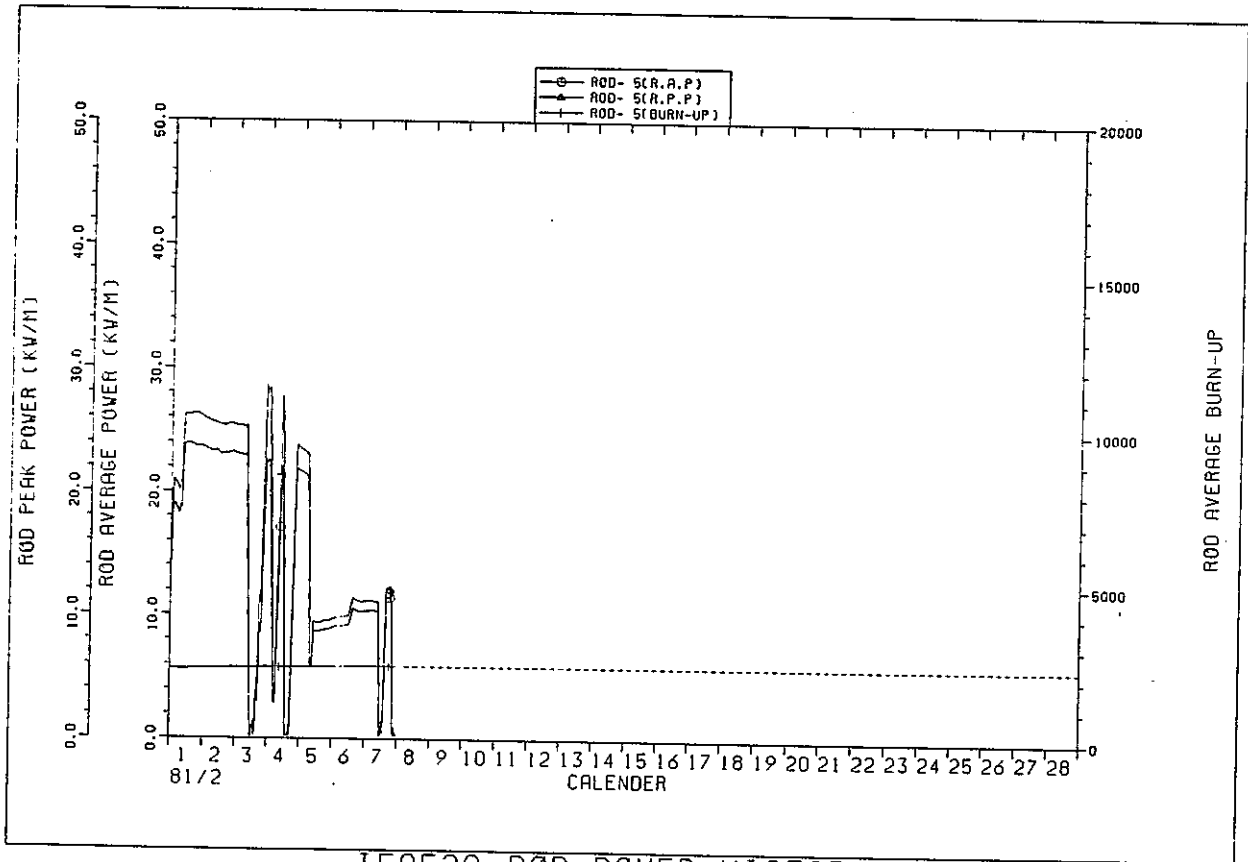

IFA529 ROD POWER HISTORY

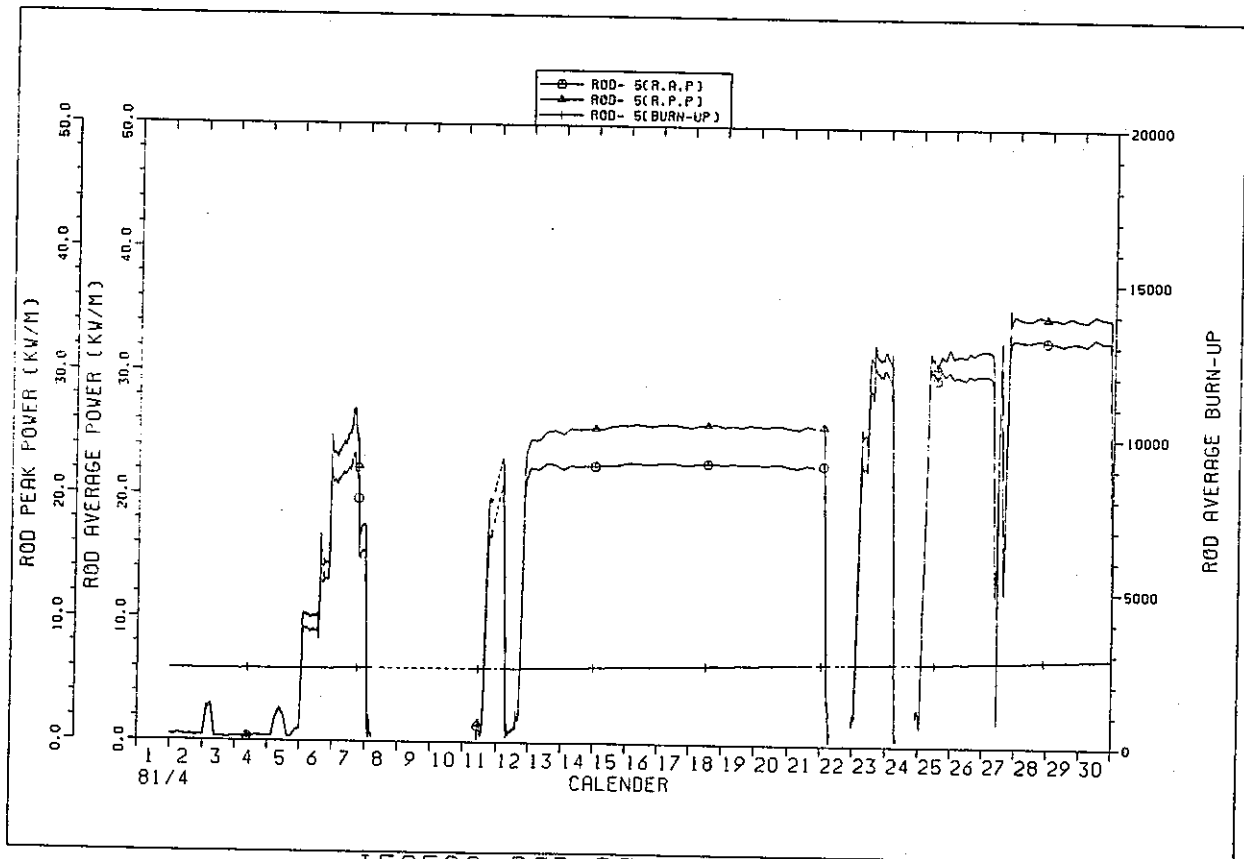

IFA529 ROD POWER HISTORY

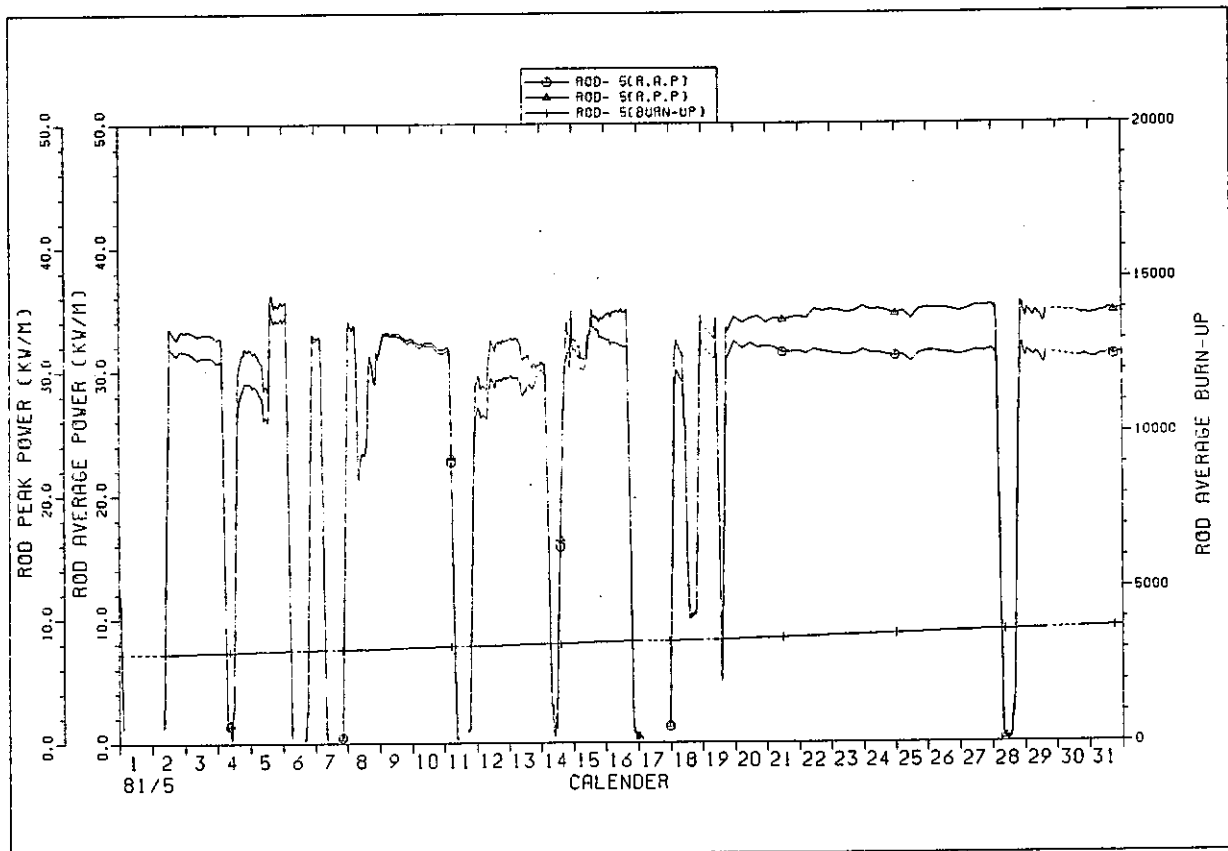

IFA529 ROD POWER HISTORY

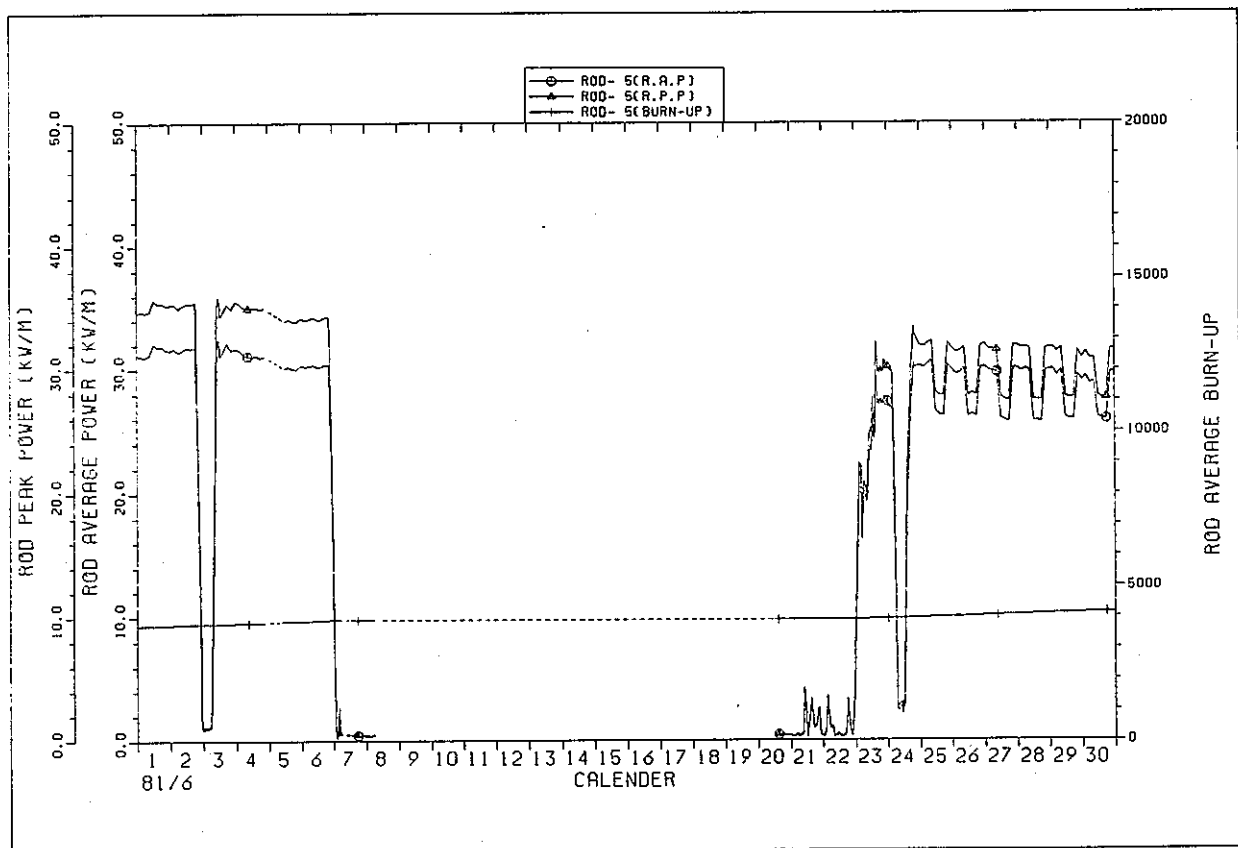

IFA529 ROD POWER HISTORY

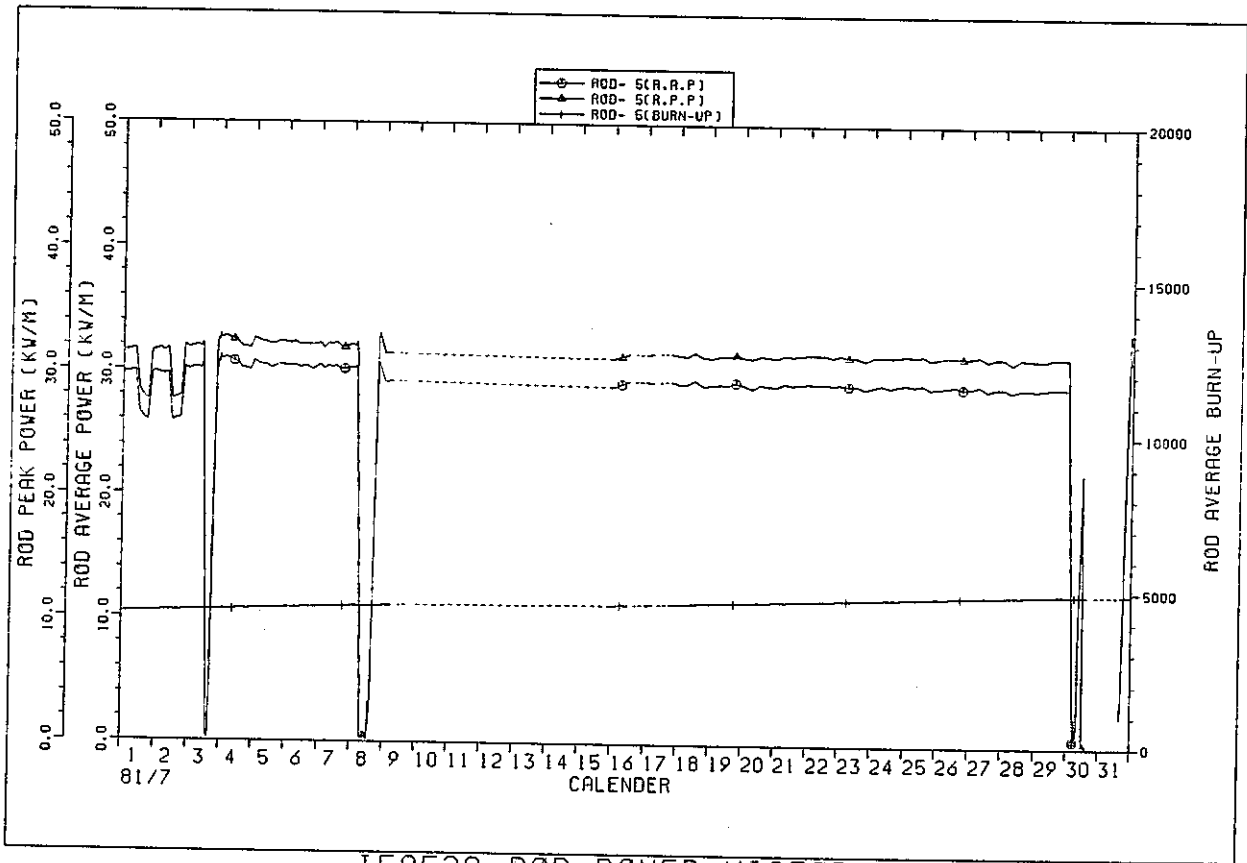

IFA529 ROD POWER HISTORY

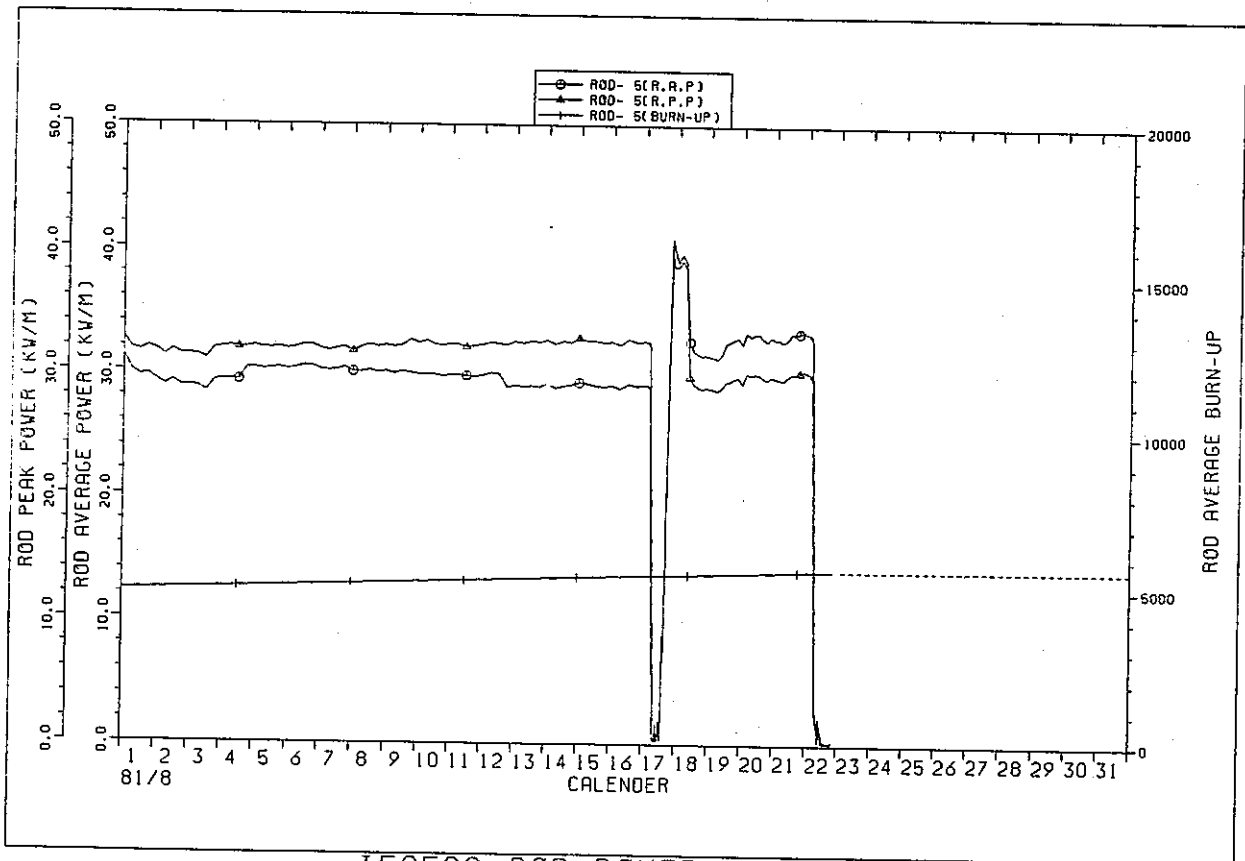

IFA529 ROD POWER HISTORY

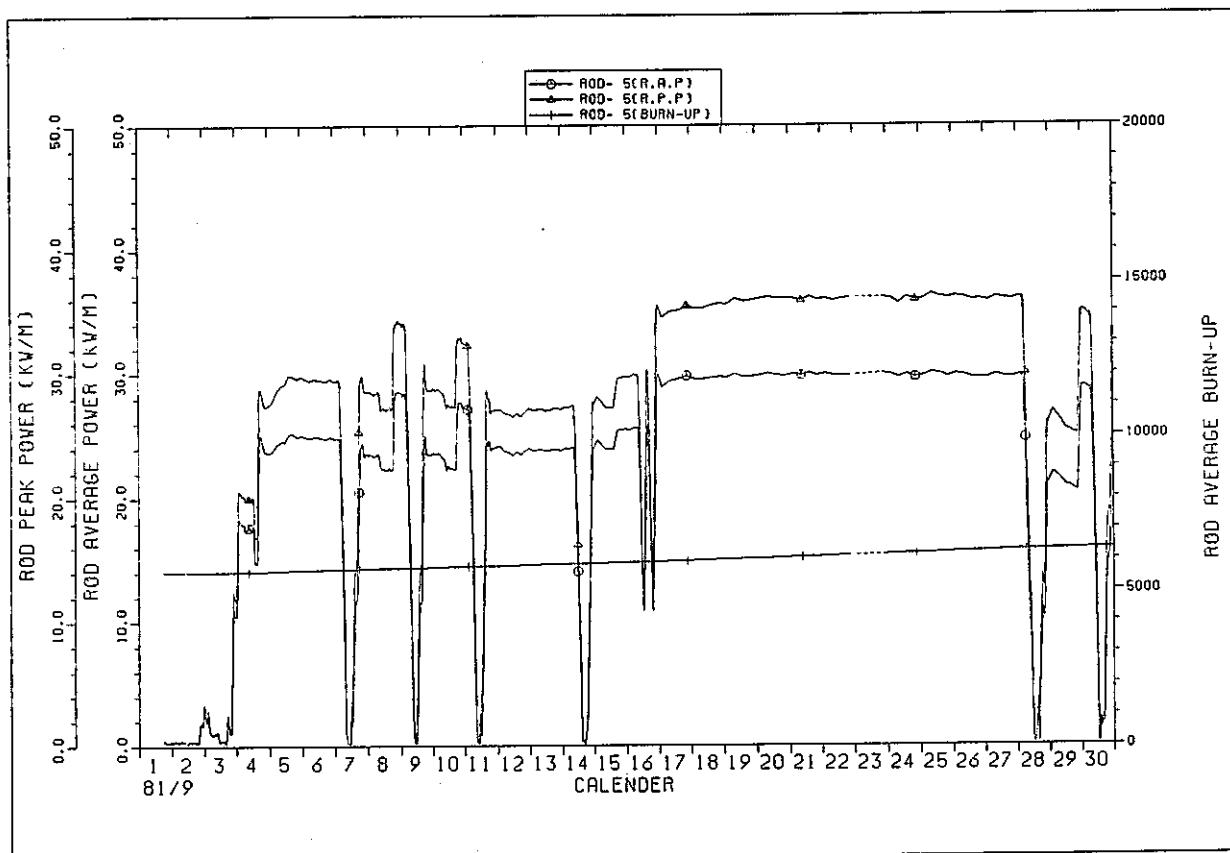

IFA529 ROD POWER HISTORY

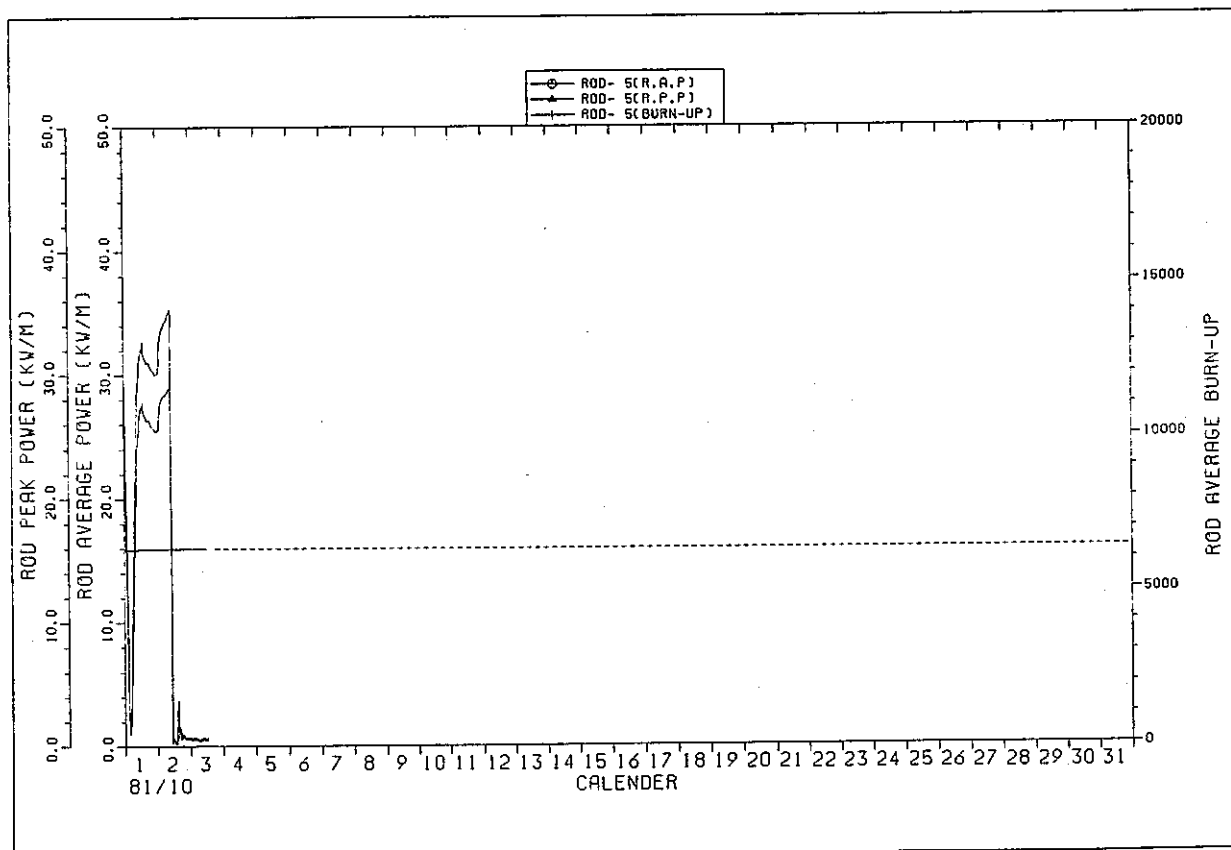

IFA529 ROD POWER HISTORY

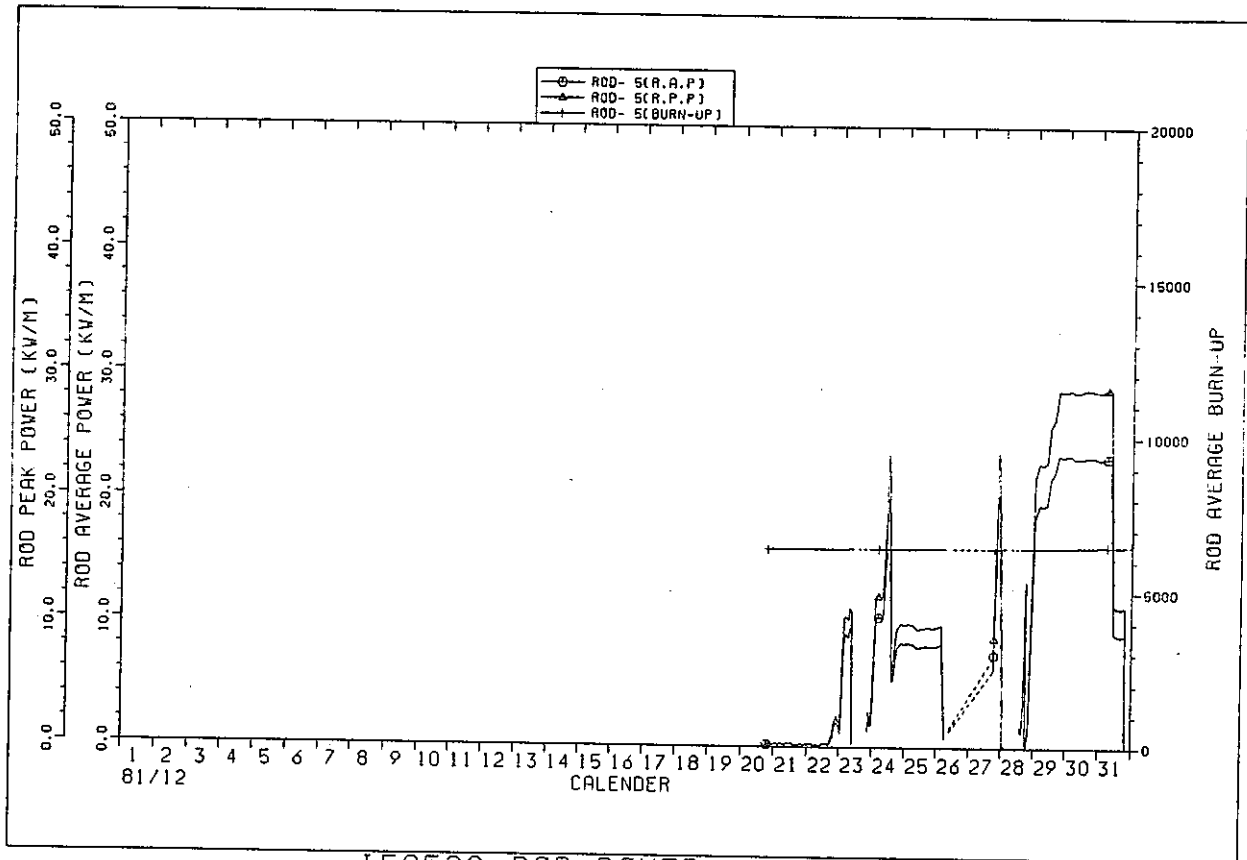

IFA529 ROD POWER HISTORY

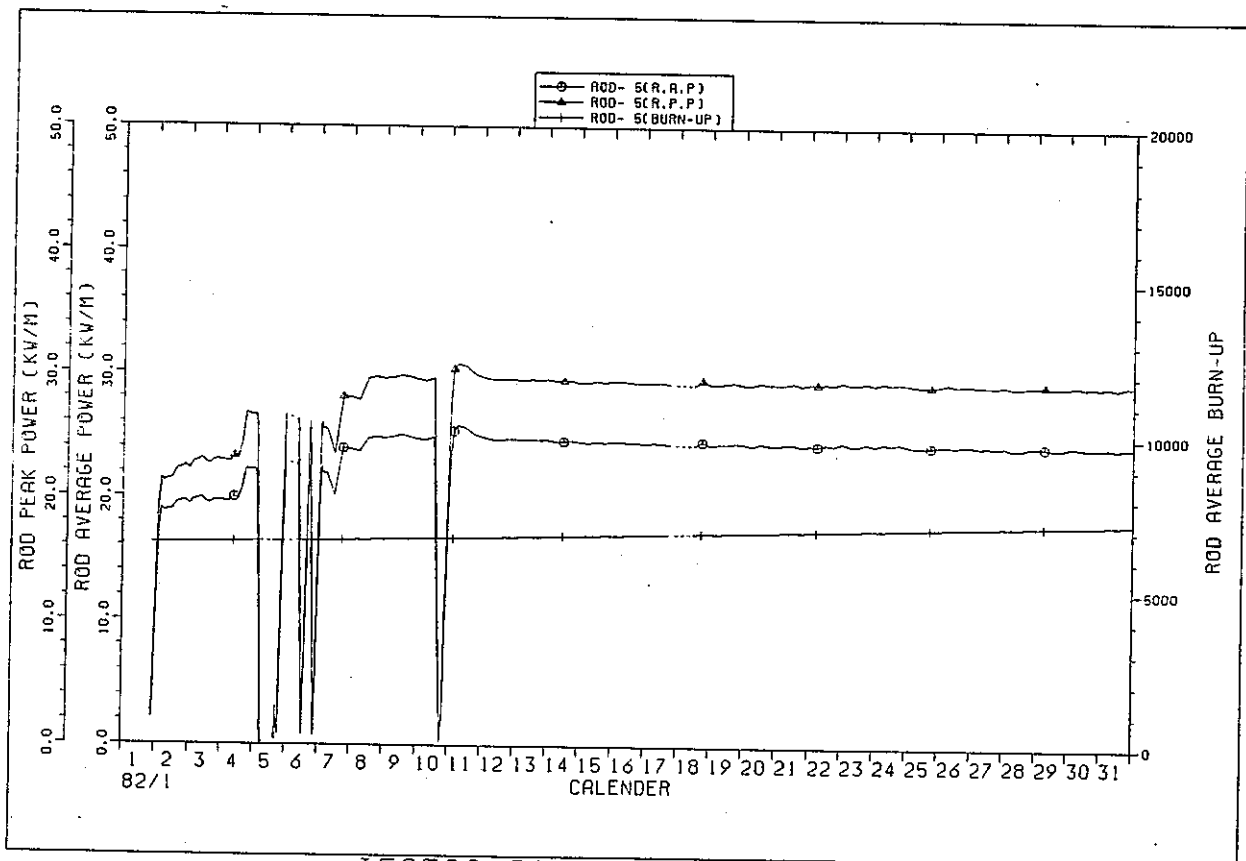

IFA529 ROD POWER HISTORY

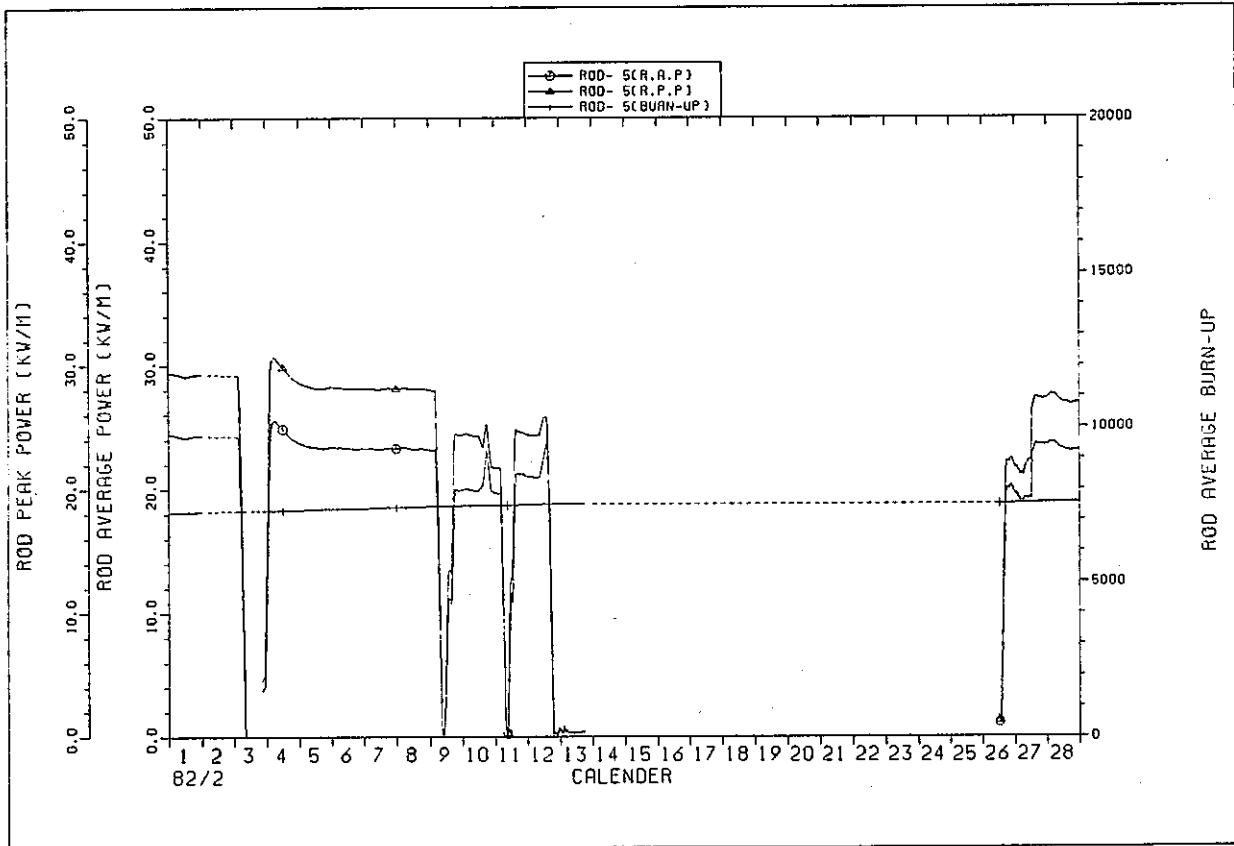

IFA529 ROD POWER HISTORY

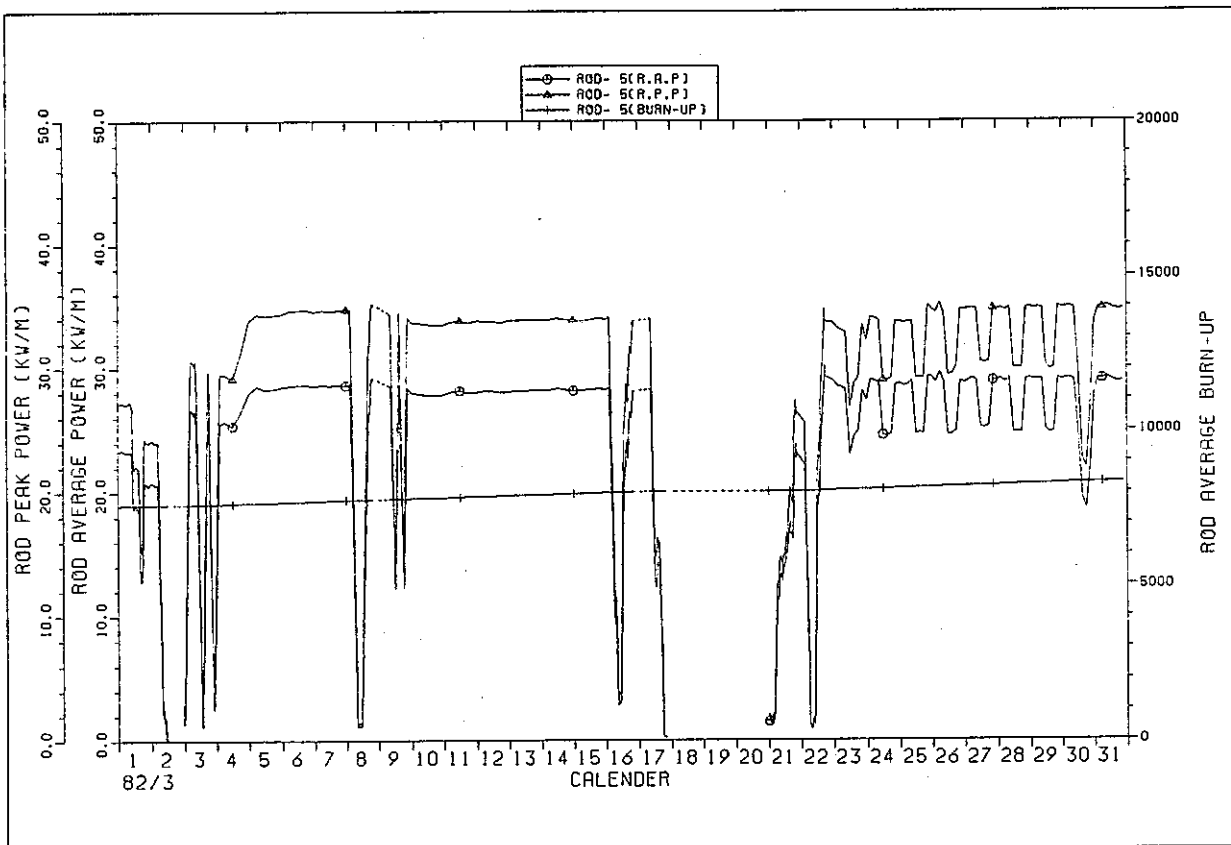

IFA529 ROD POWER HISTORY

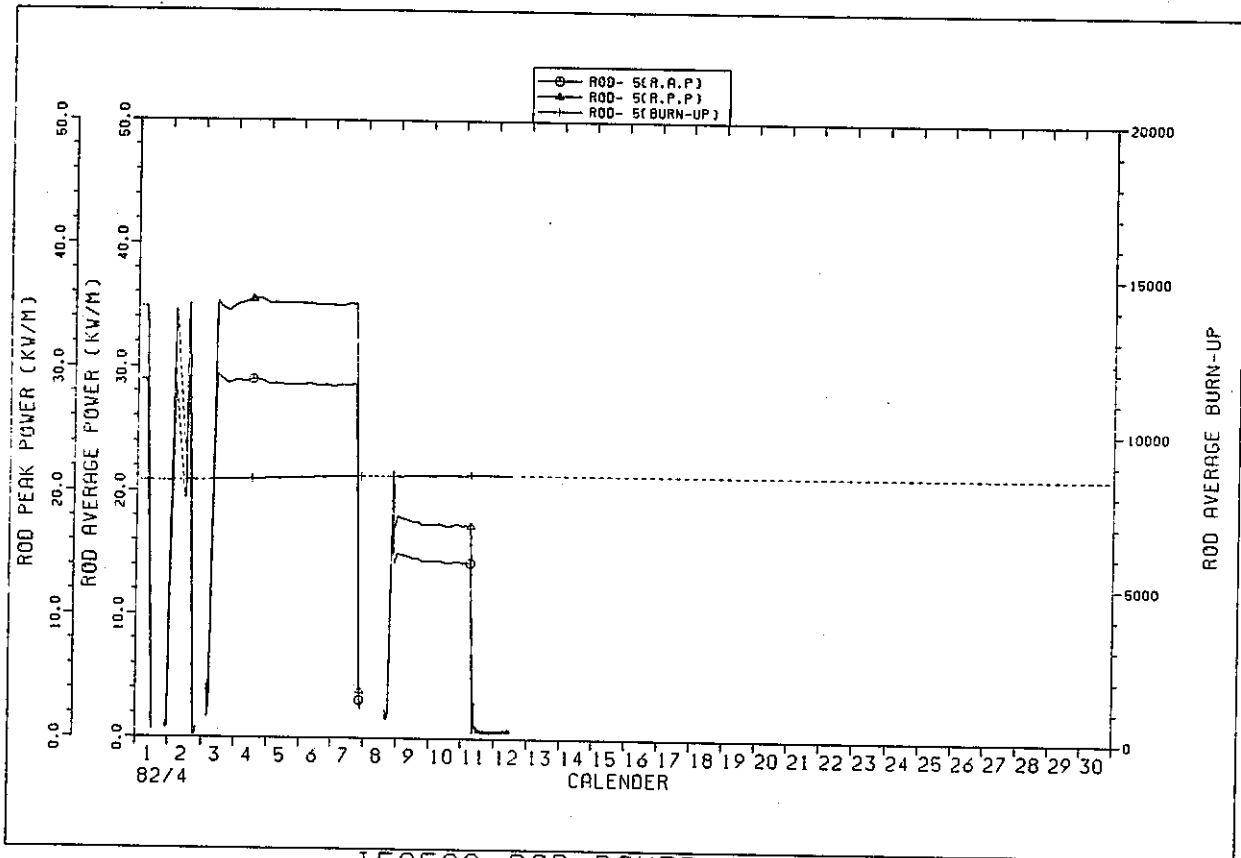

IFA529 ROD POWER HISTORY

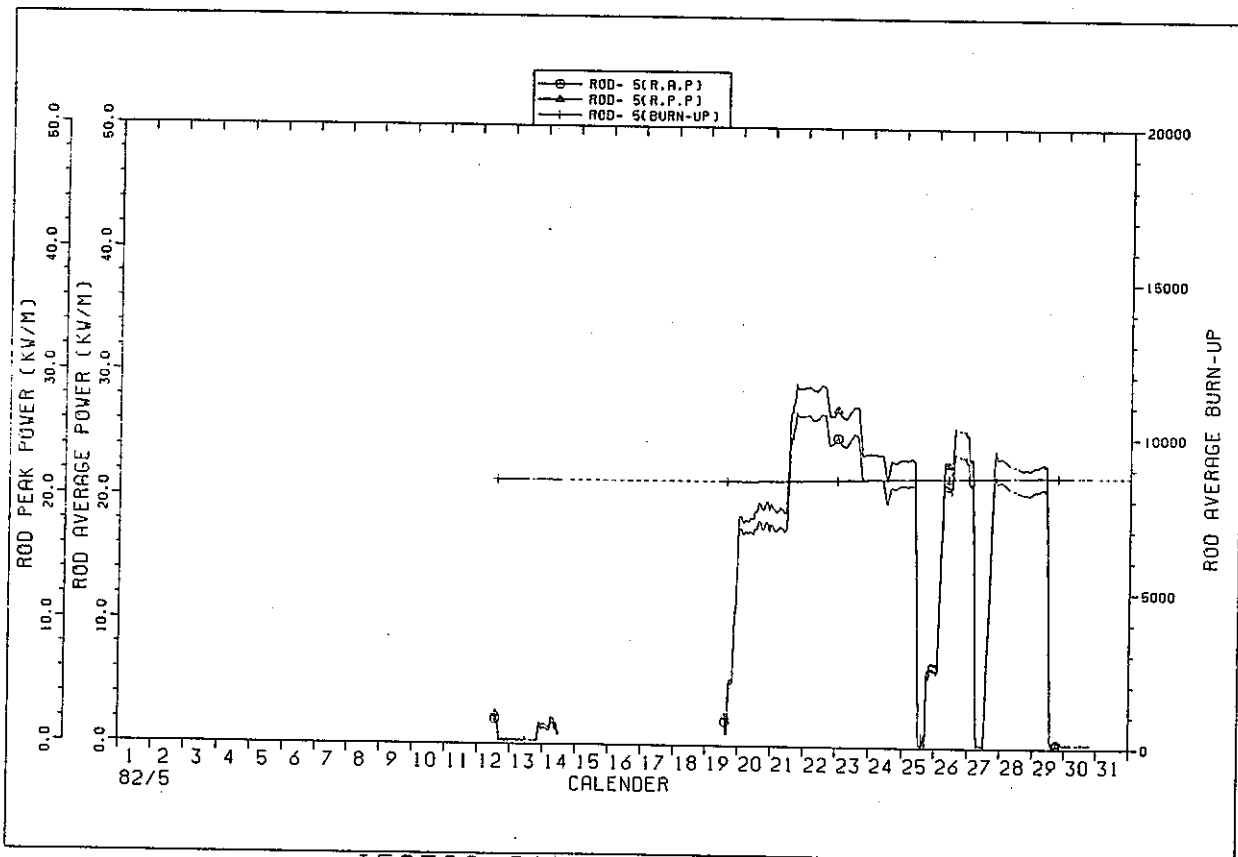

IFA529 ROD POWER HISTORY

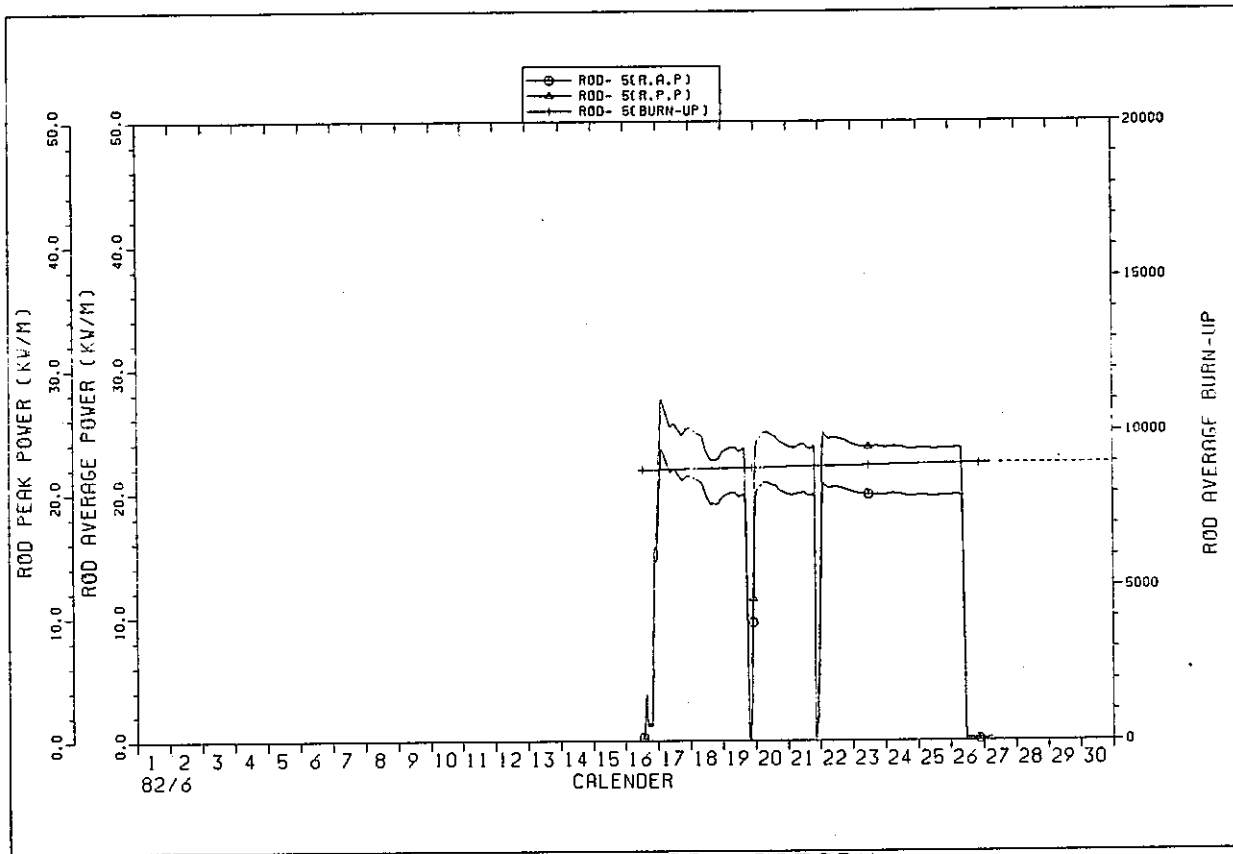

IFA529 ROD POWER HISTORY

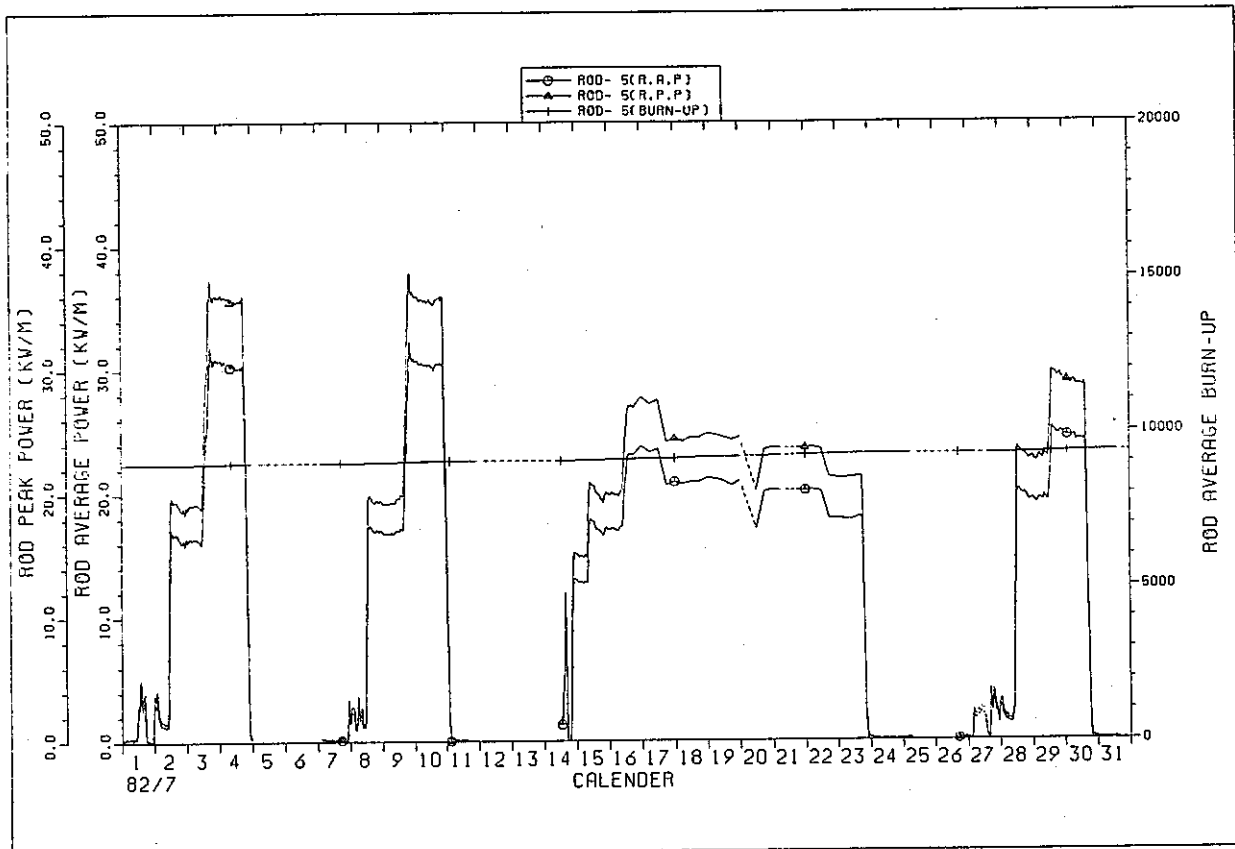

IFA529 ROD POWER HISTORY

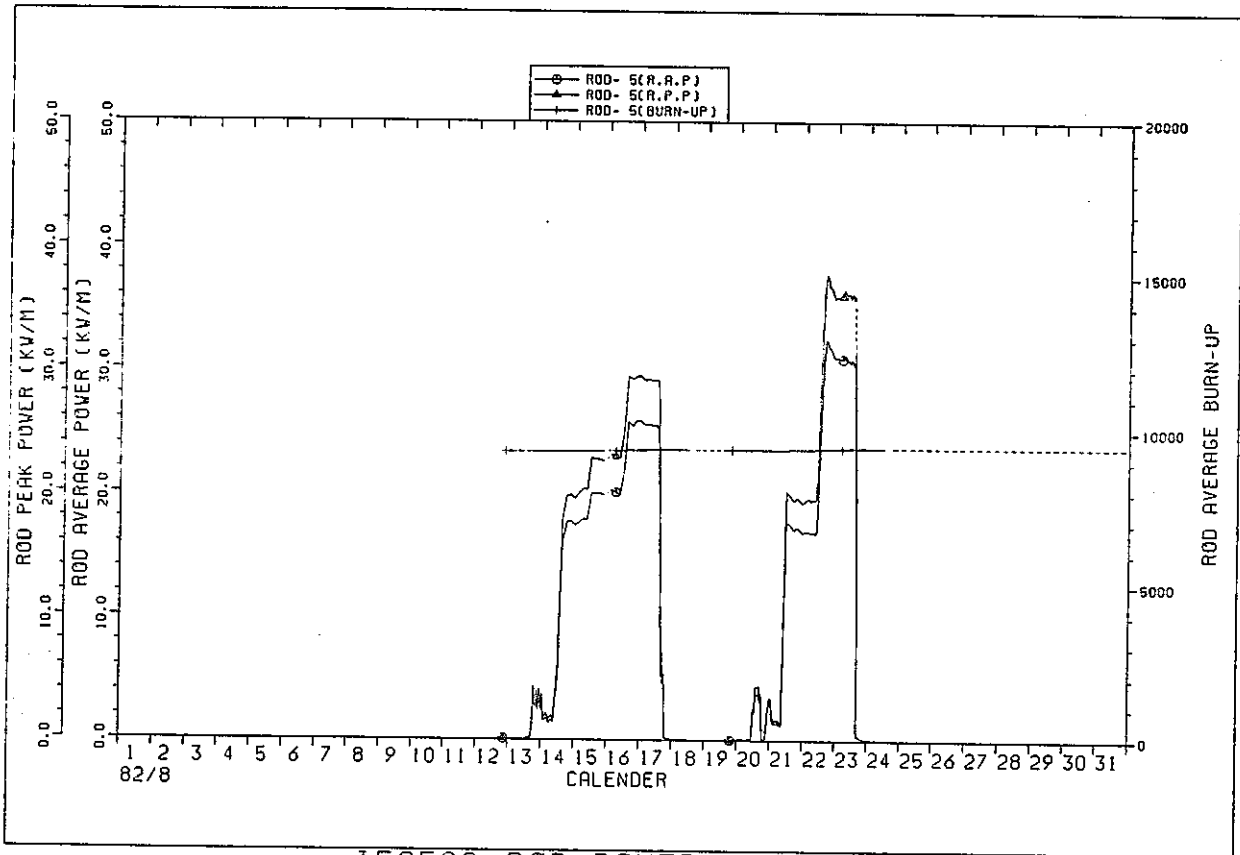

IFA529 ROD POWER HISTORY

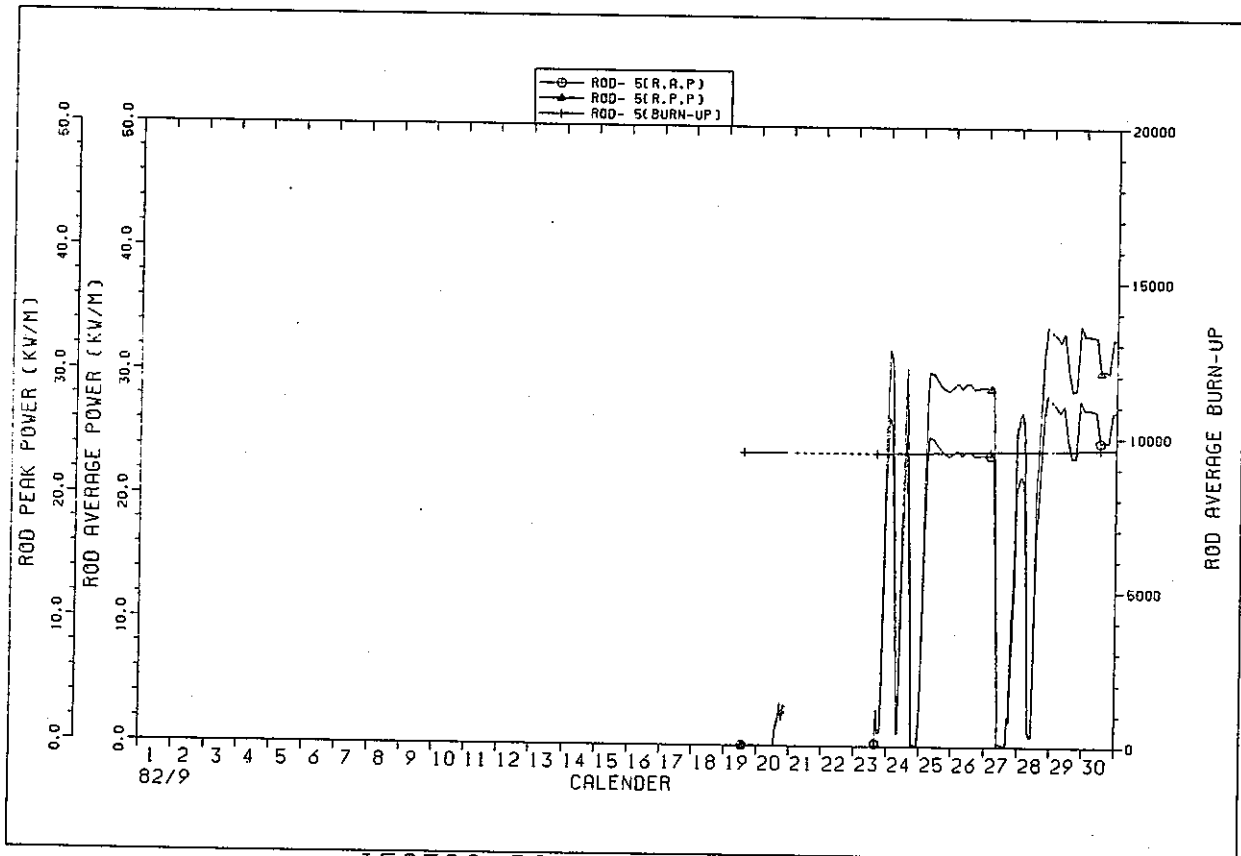

IFA529 ROD POWER HISTORY

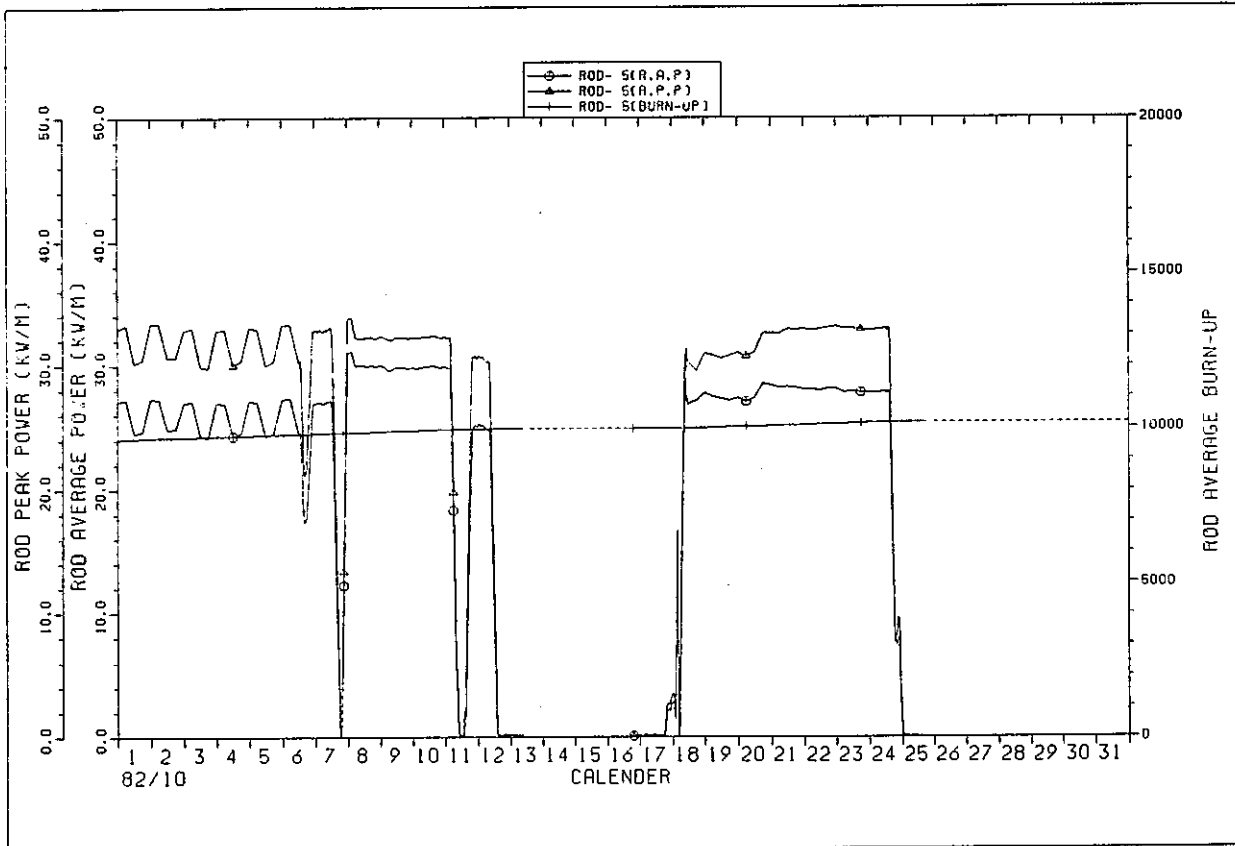

IFA529 ROD POWER HISTORY

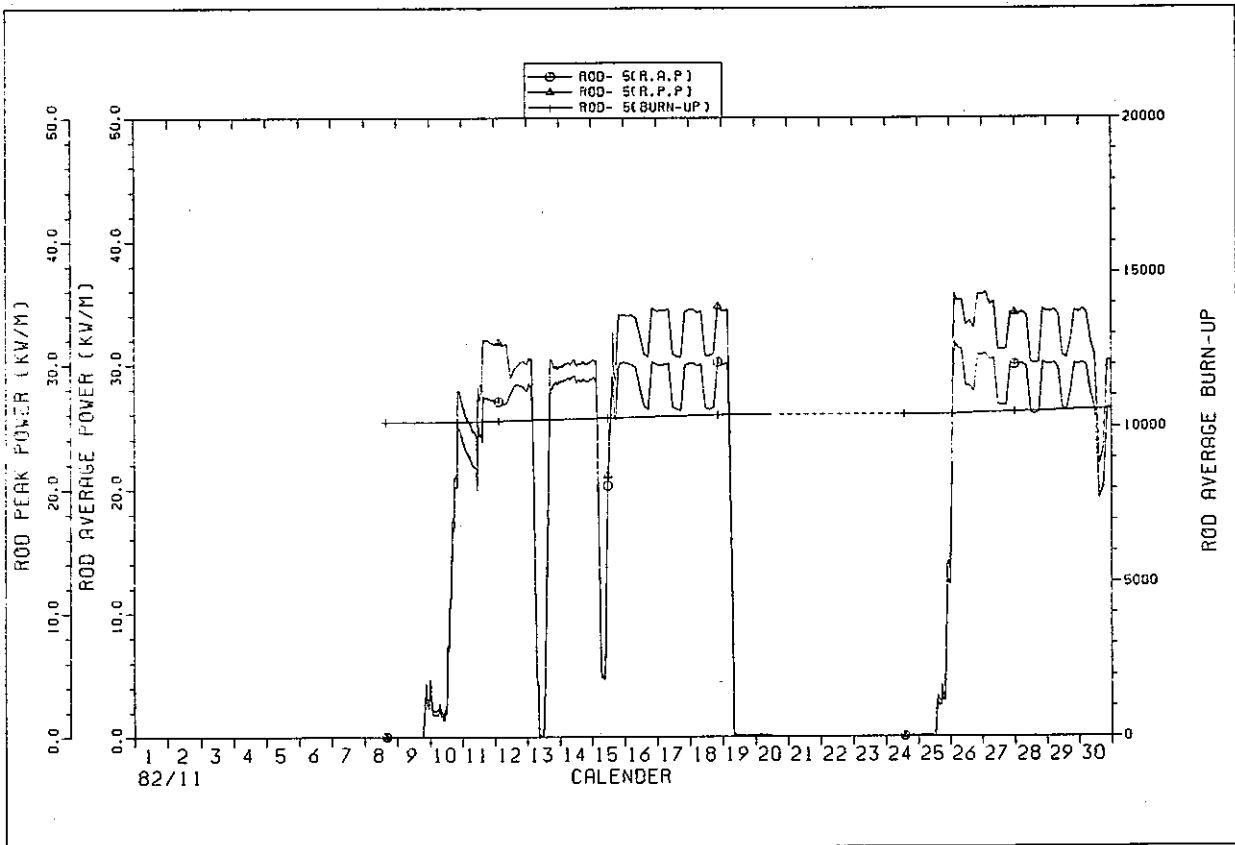

IFA529 ROD POWER HISTORY

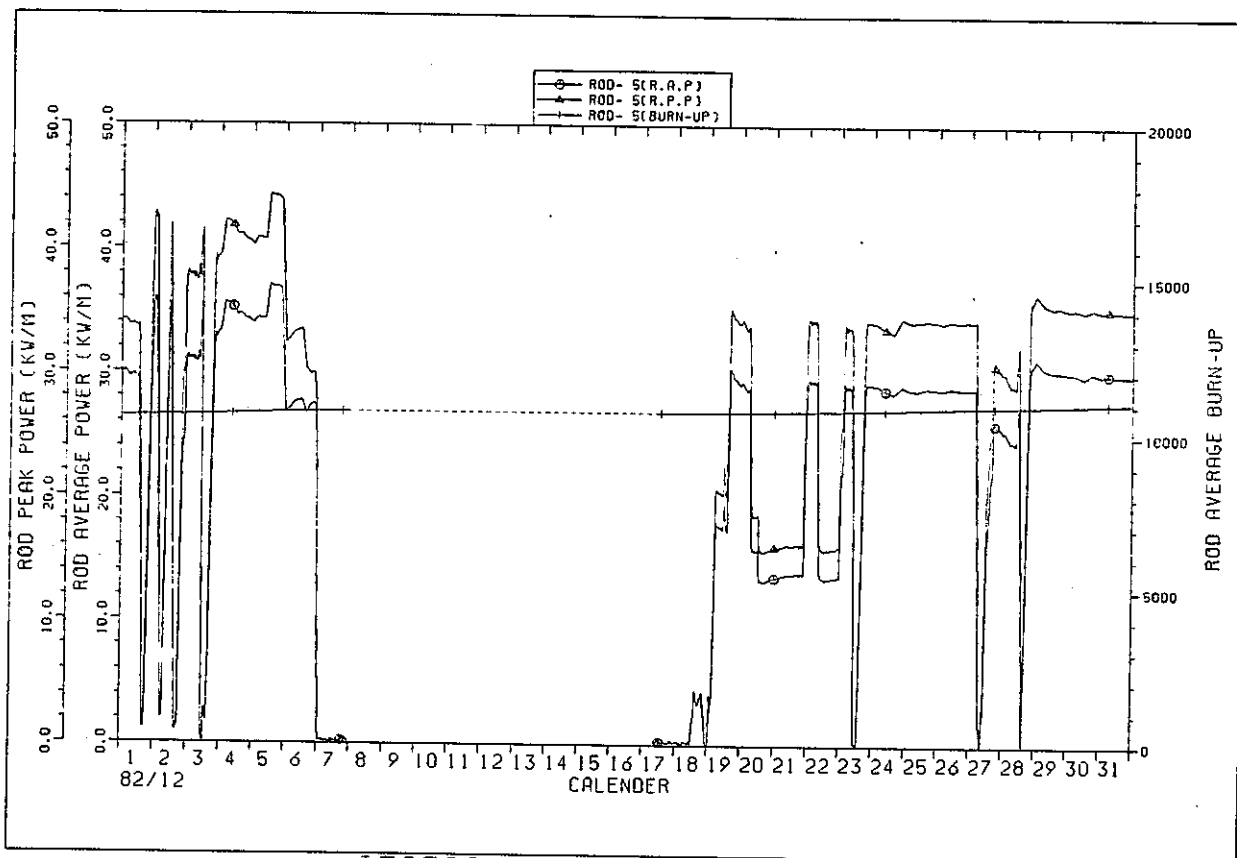

IFA529 ROD POWER HISTORY

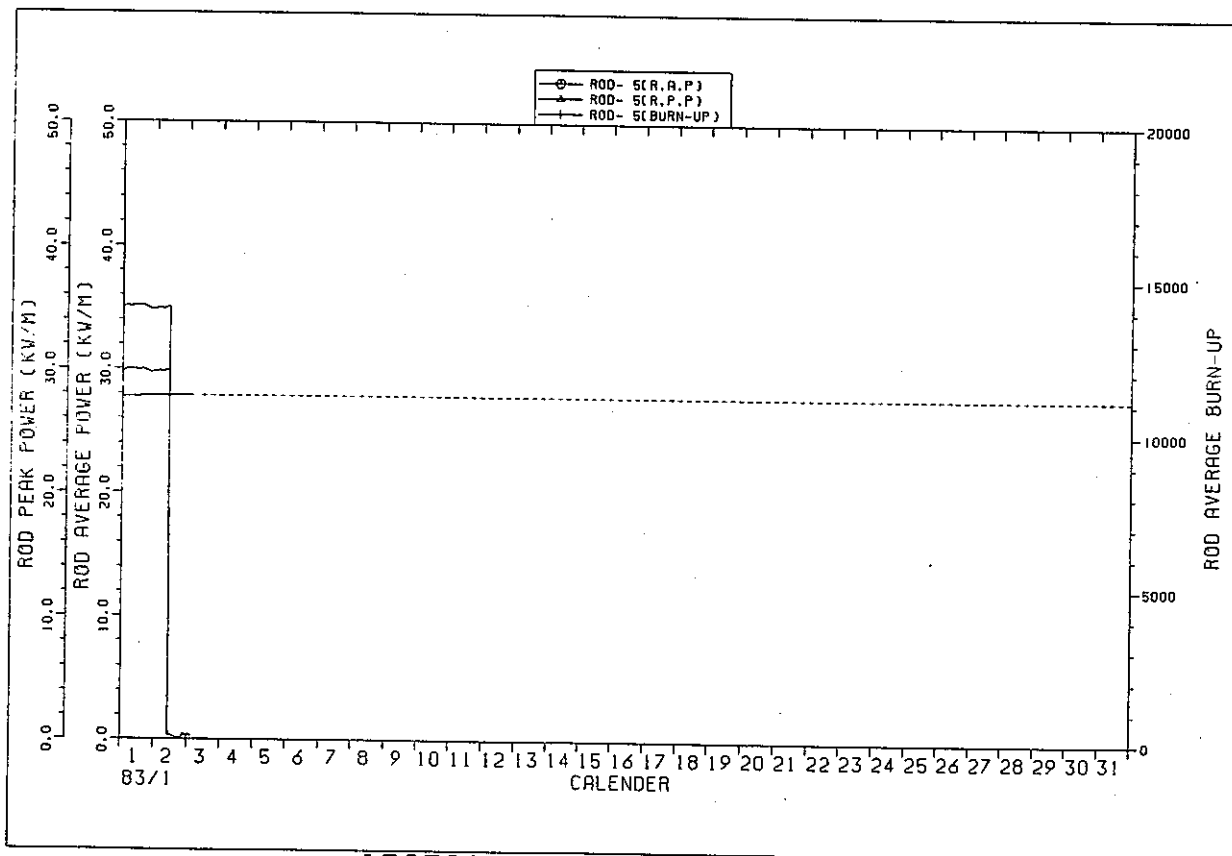

IFA529 ROD POWER HISTORY

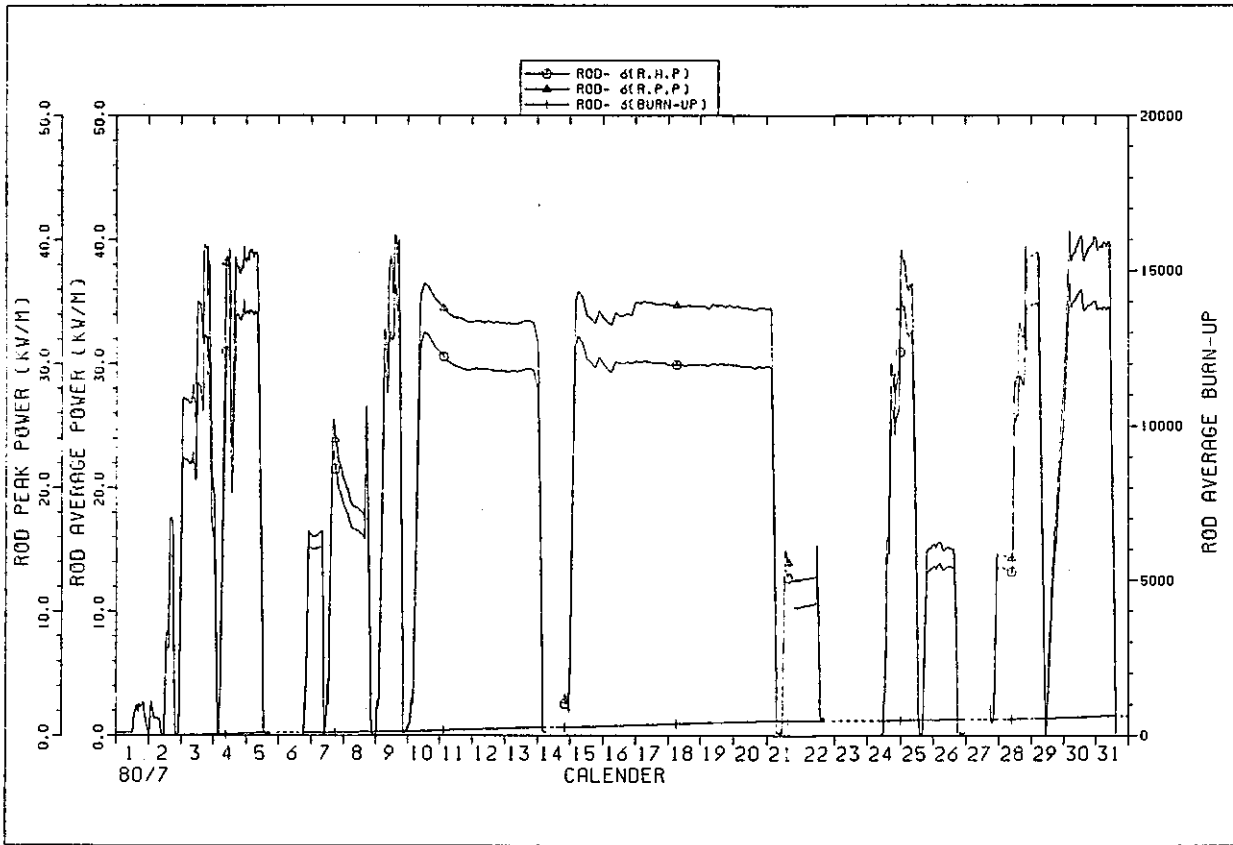

IFA529 ROD POWER HISTORY

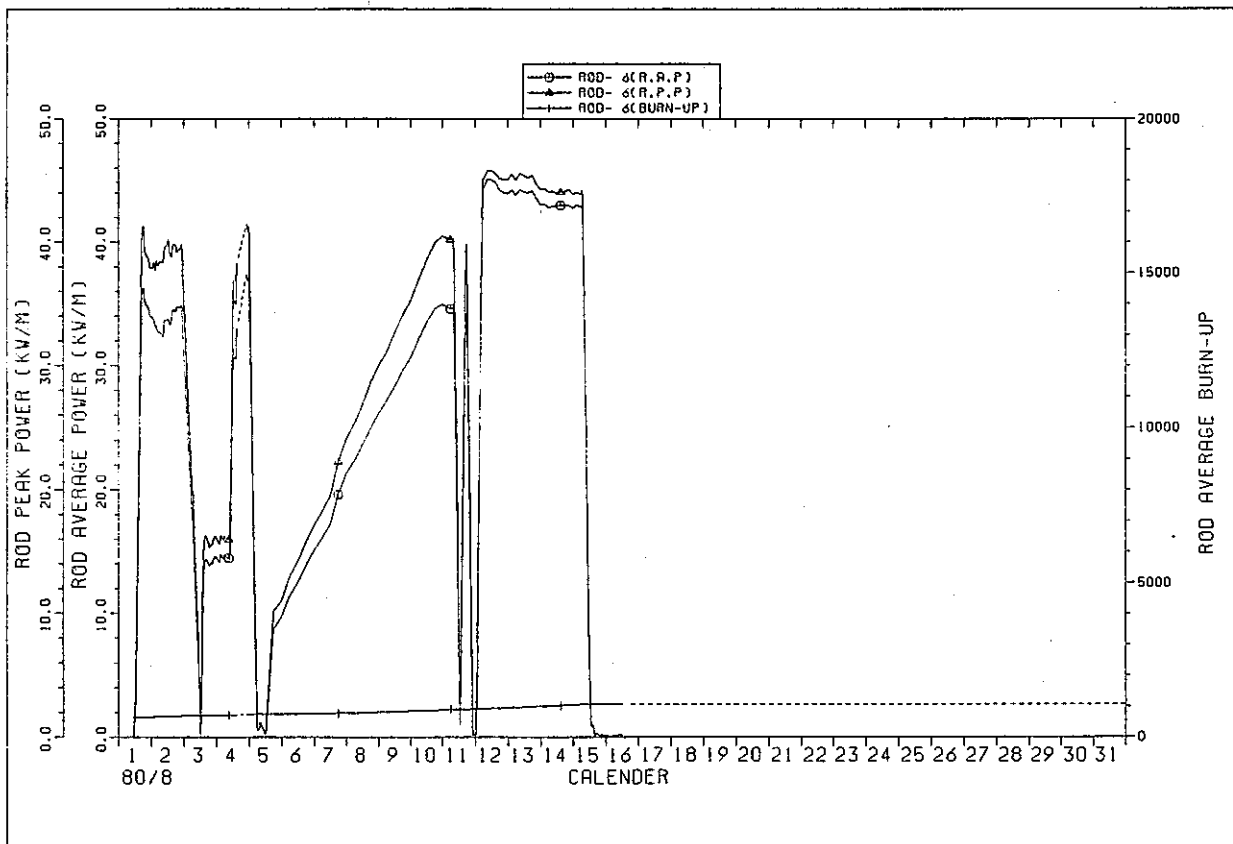

IFA529 ROD POWER HISTORY

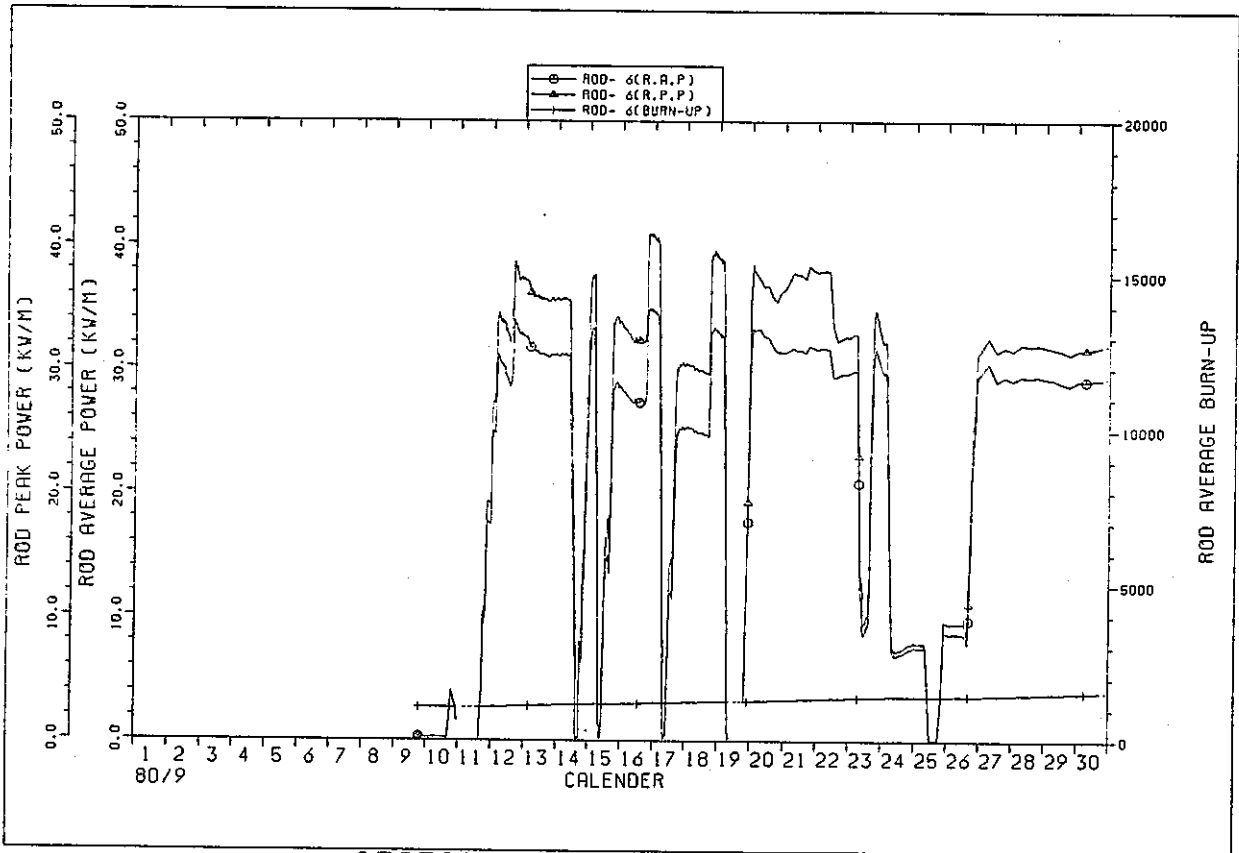

IFA529 ROD POWER HISTORY

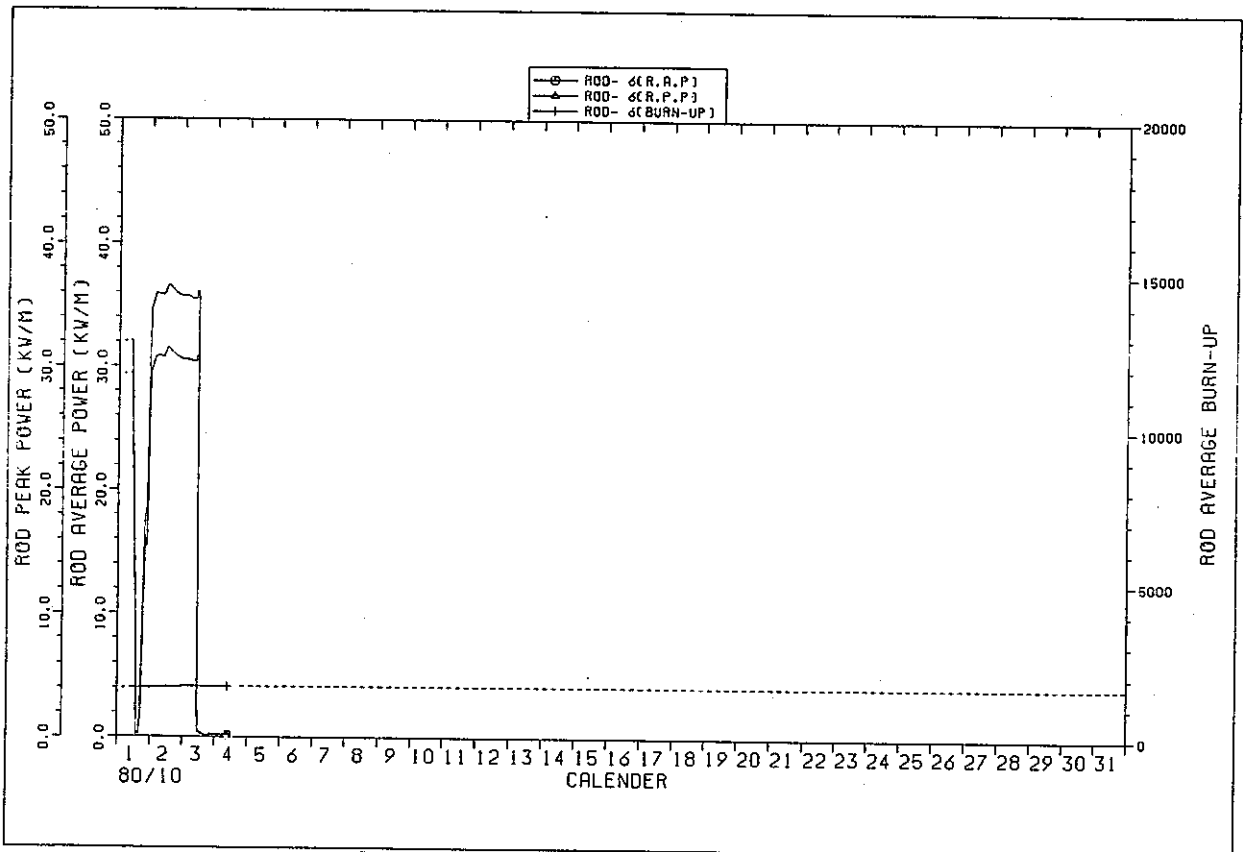

IFA529 ROD POWER HISTORY

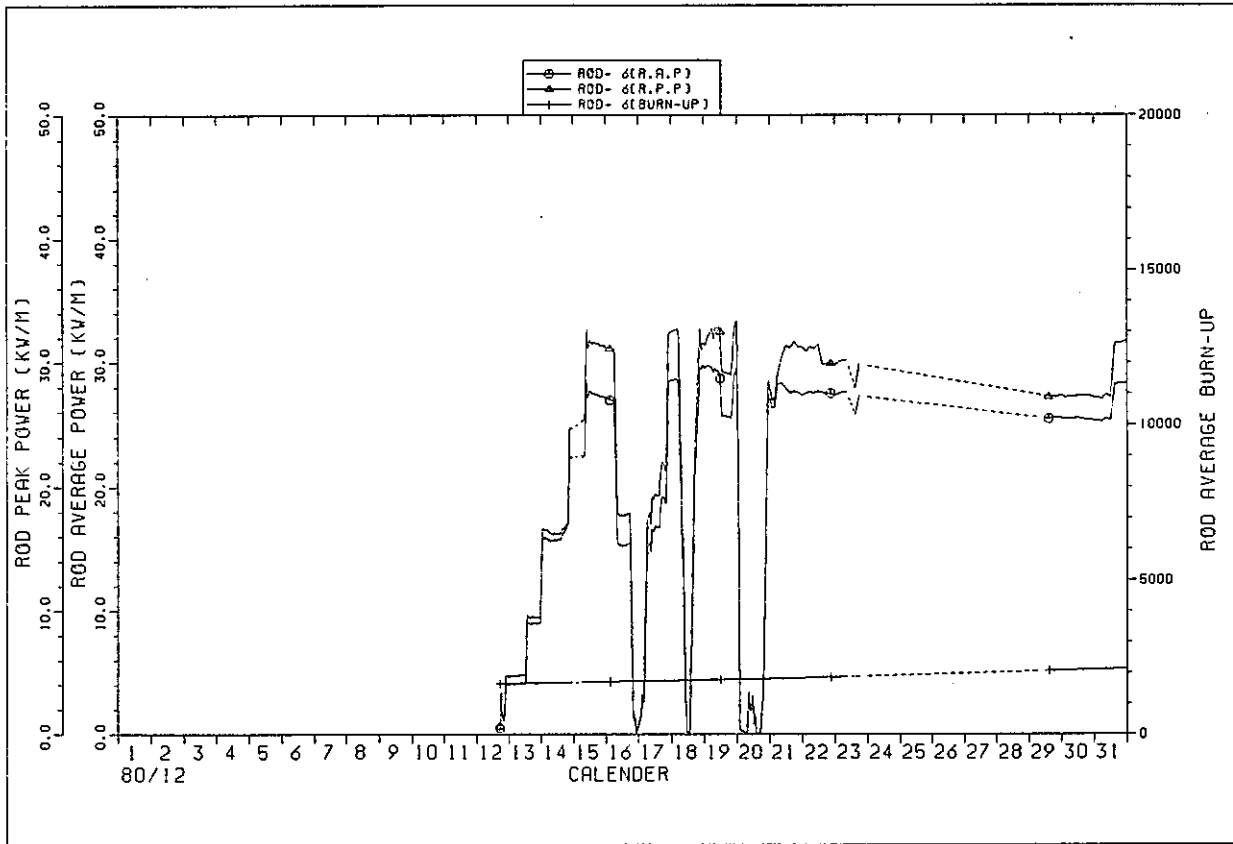

IFA529 ROD POWER HISTORY

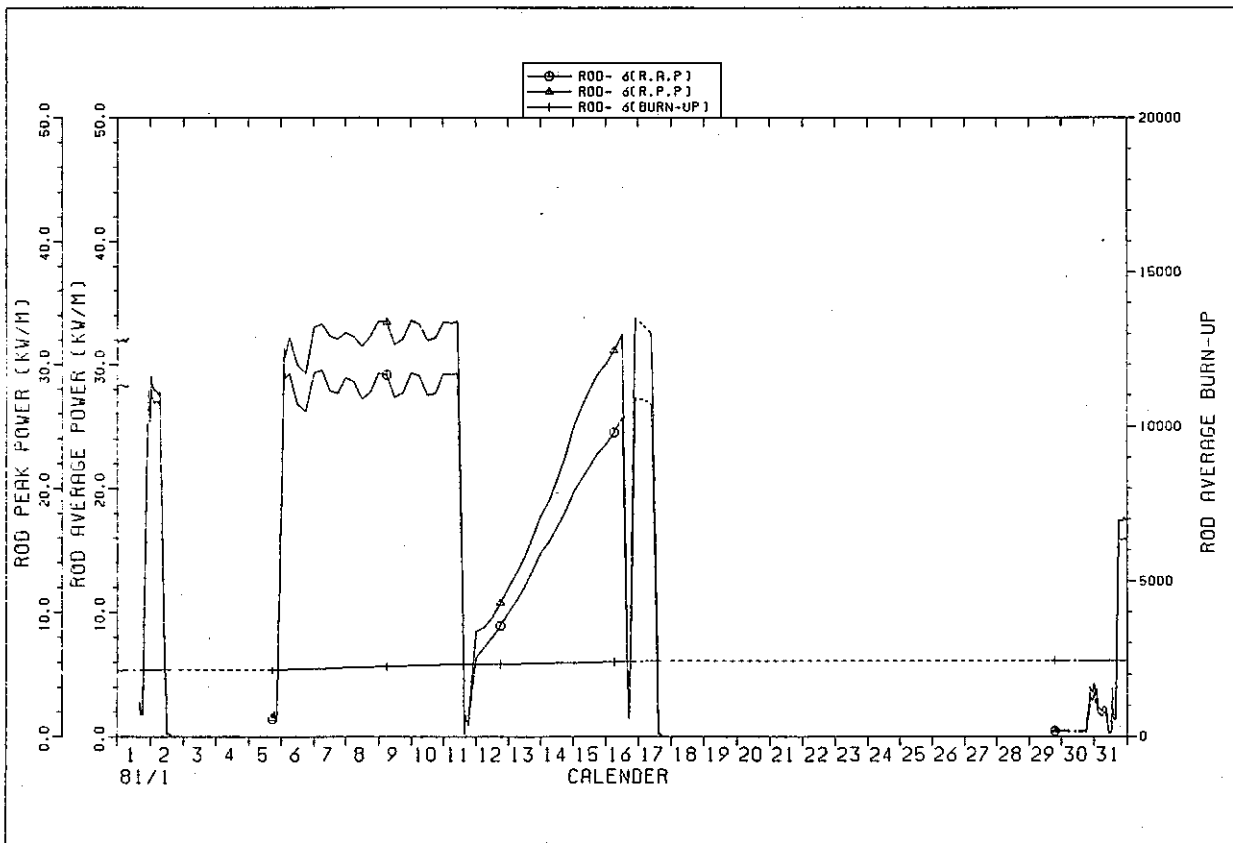

IFA529 ROD POWER HISTORY

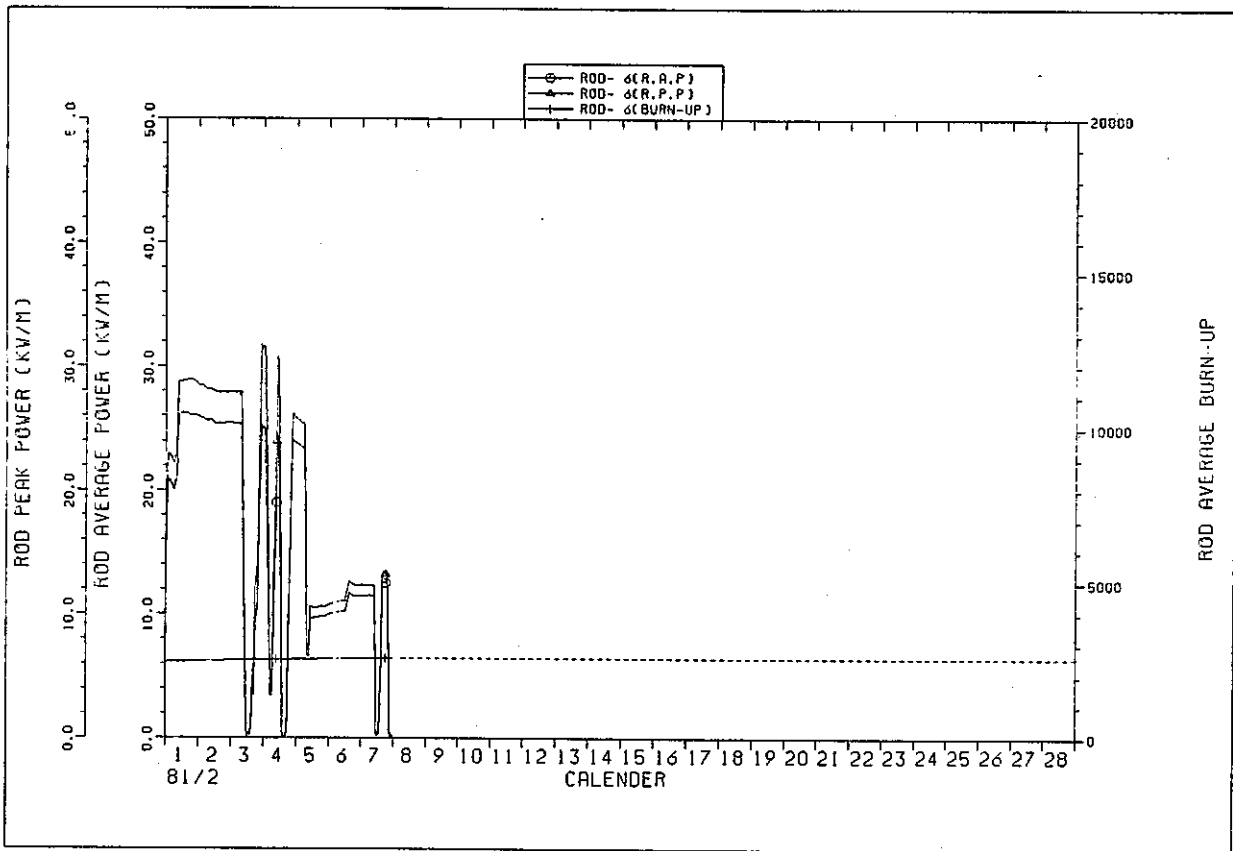

IFA529 ROD POWER HISTORY

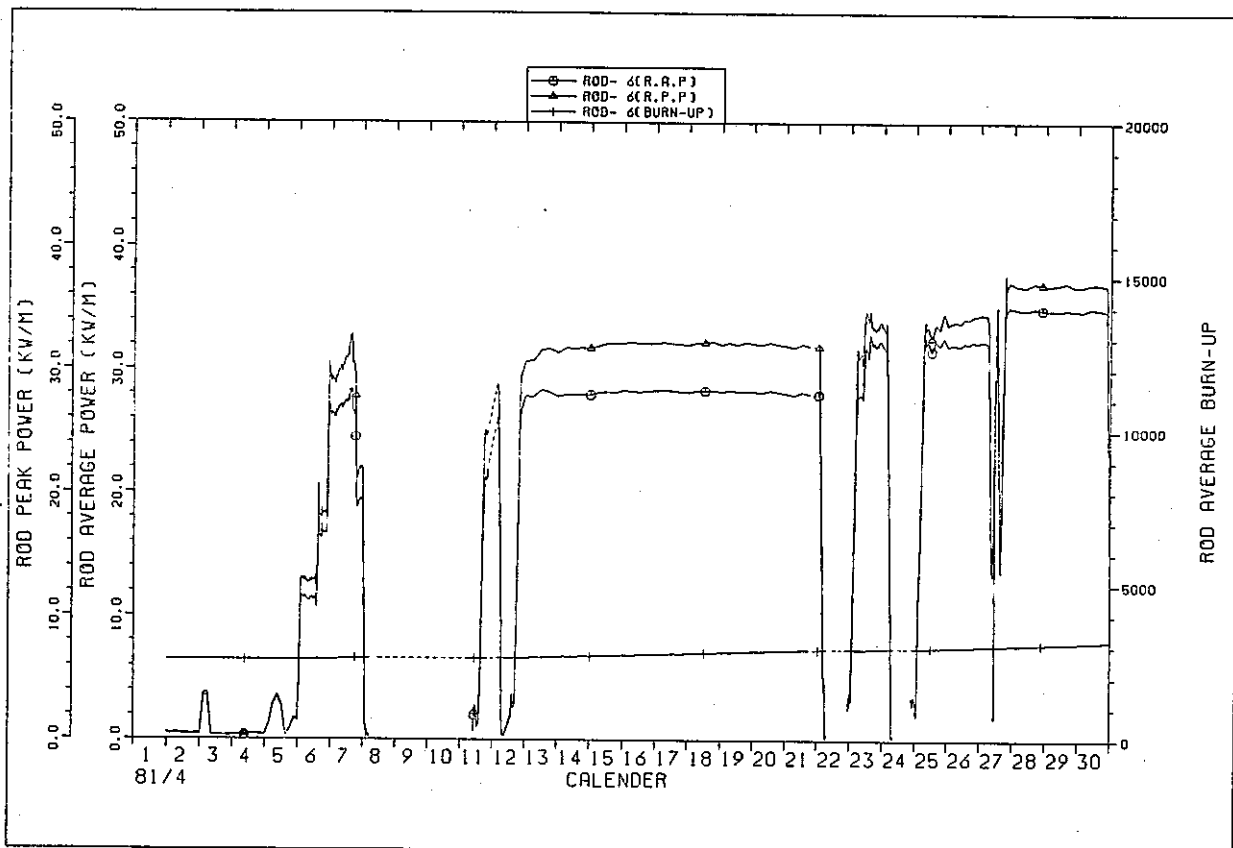

IFA529 ROD POWER HISTORY

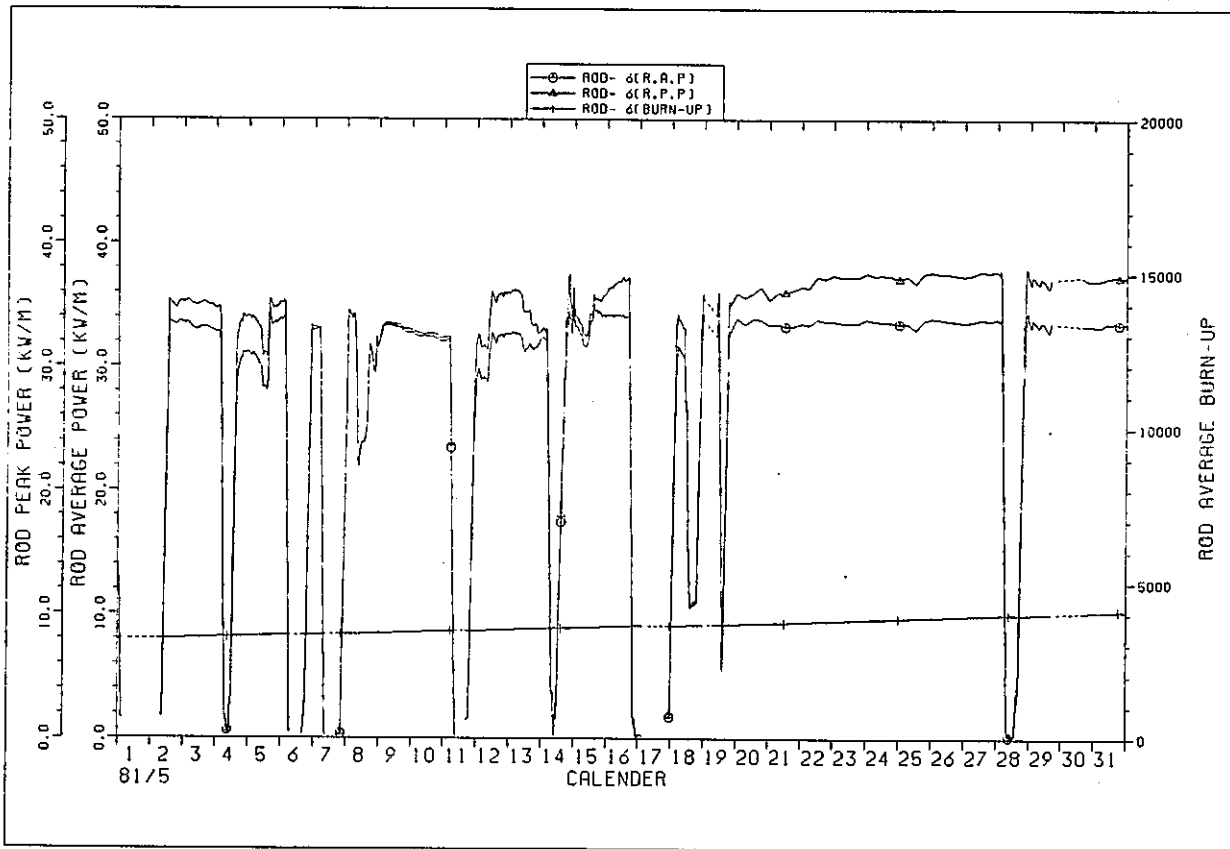

IFA529 ROD POWER HISTORY

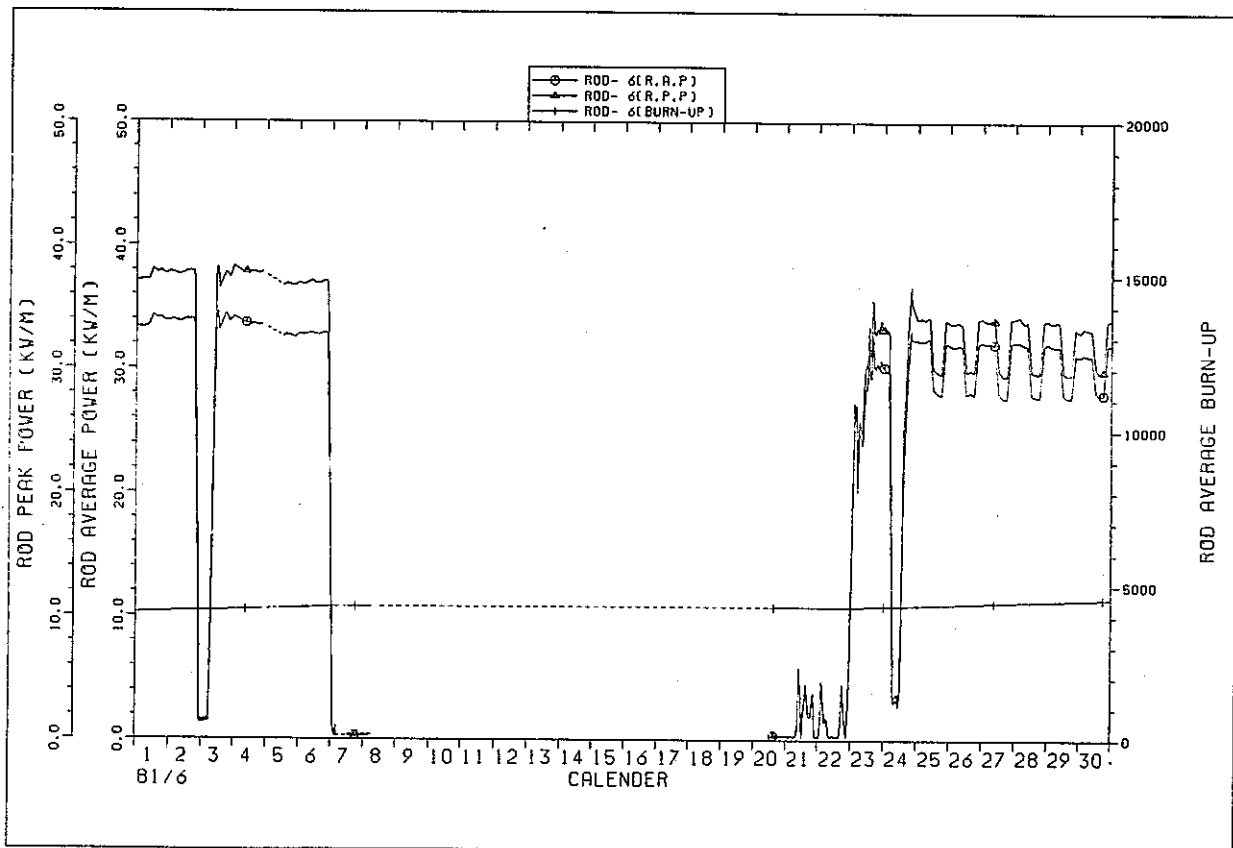

IFA529 ROD POWER HISTORY

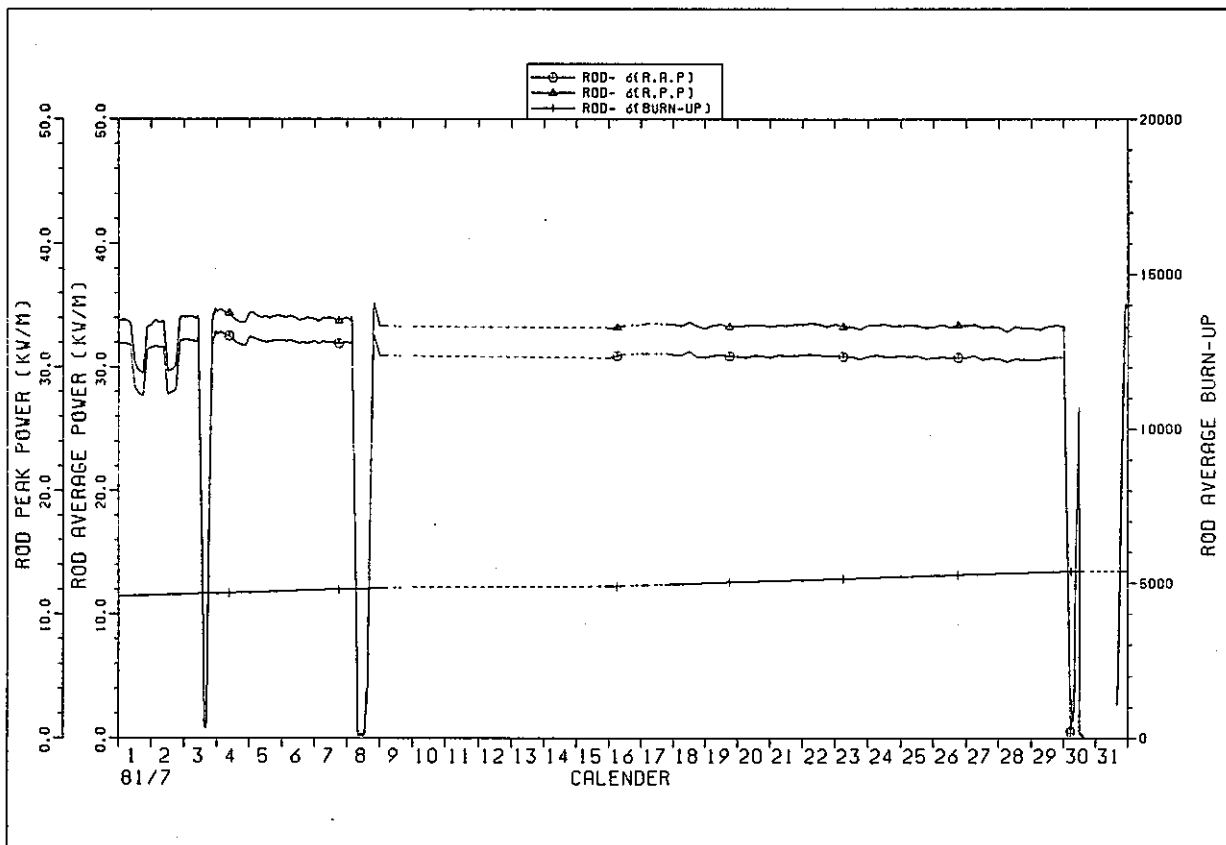

IFA529 ROD POWER HISTORY

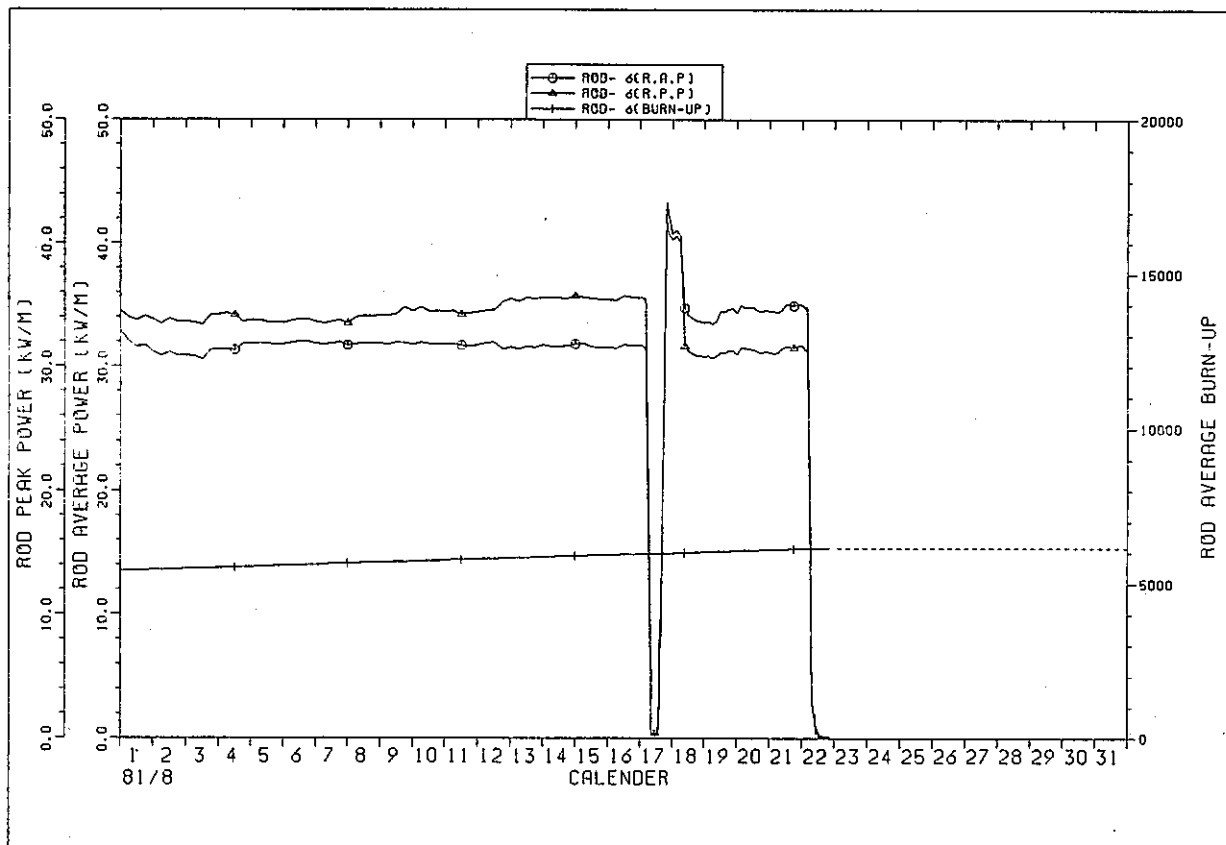

IFA529 ROD POWER HISTORY

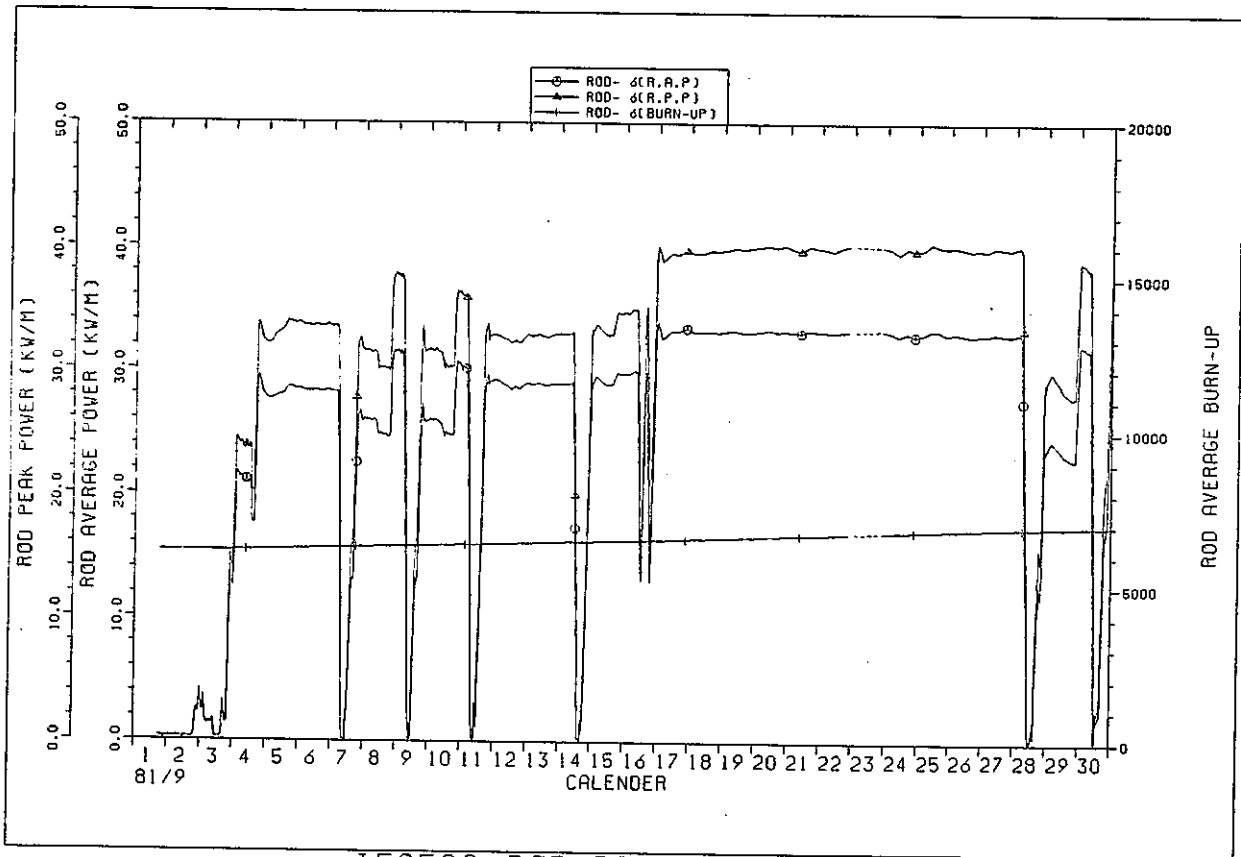

IFA529 ROD POWER HISTORY

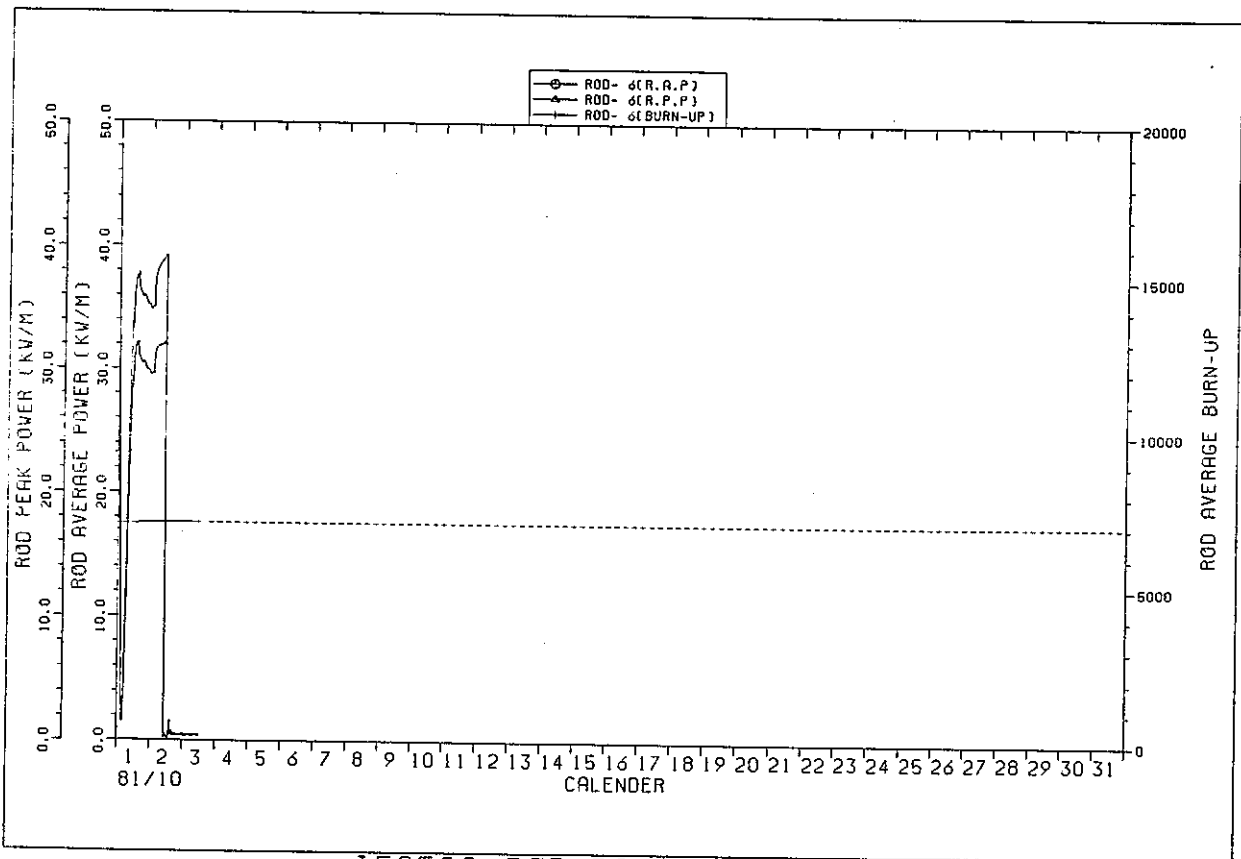

IFA529 ROD POWER HISTORY

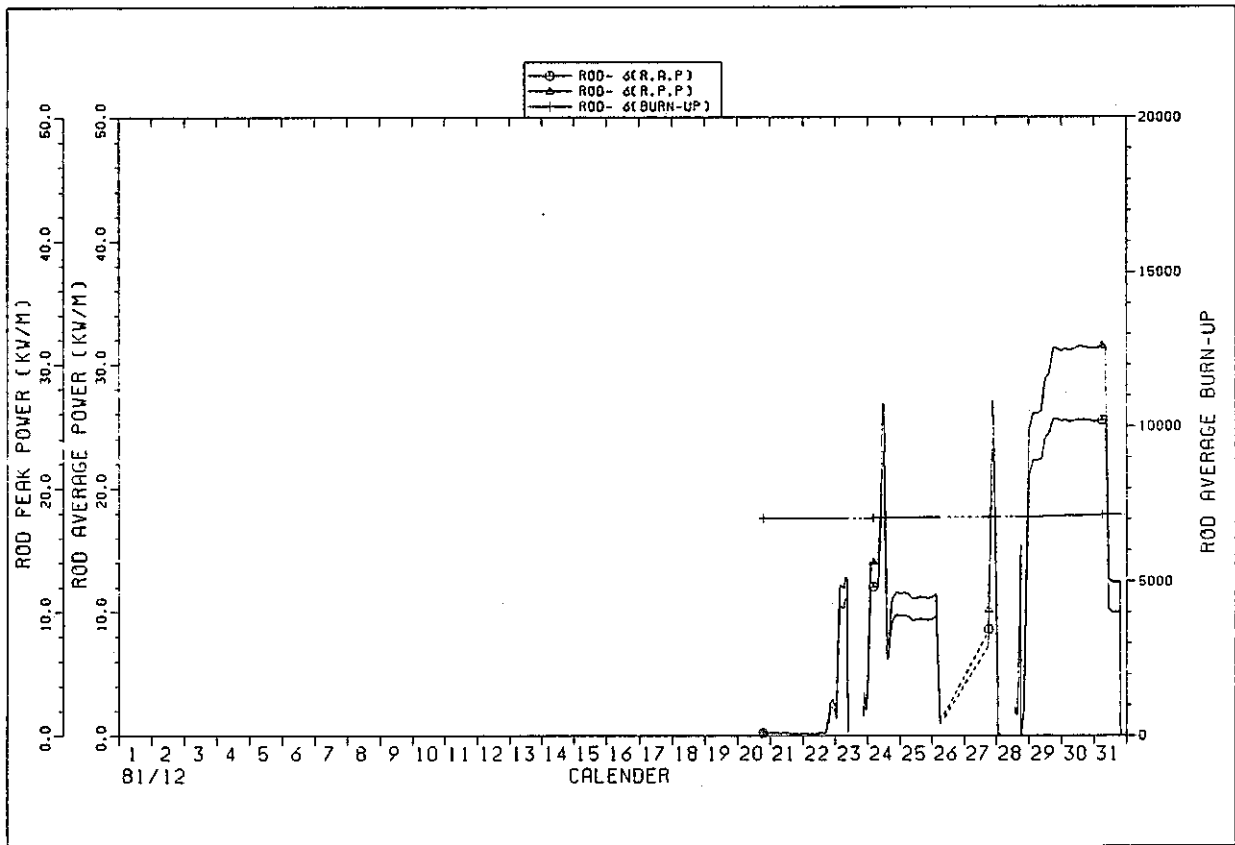

IFA529 ROD POWER HISTORY

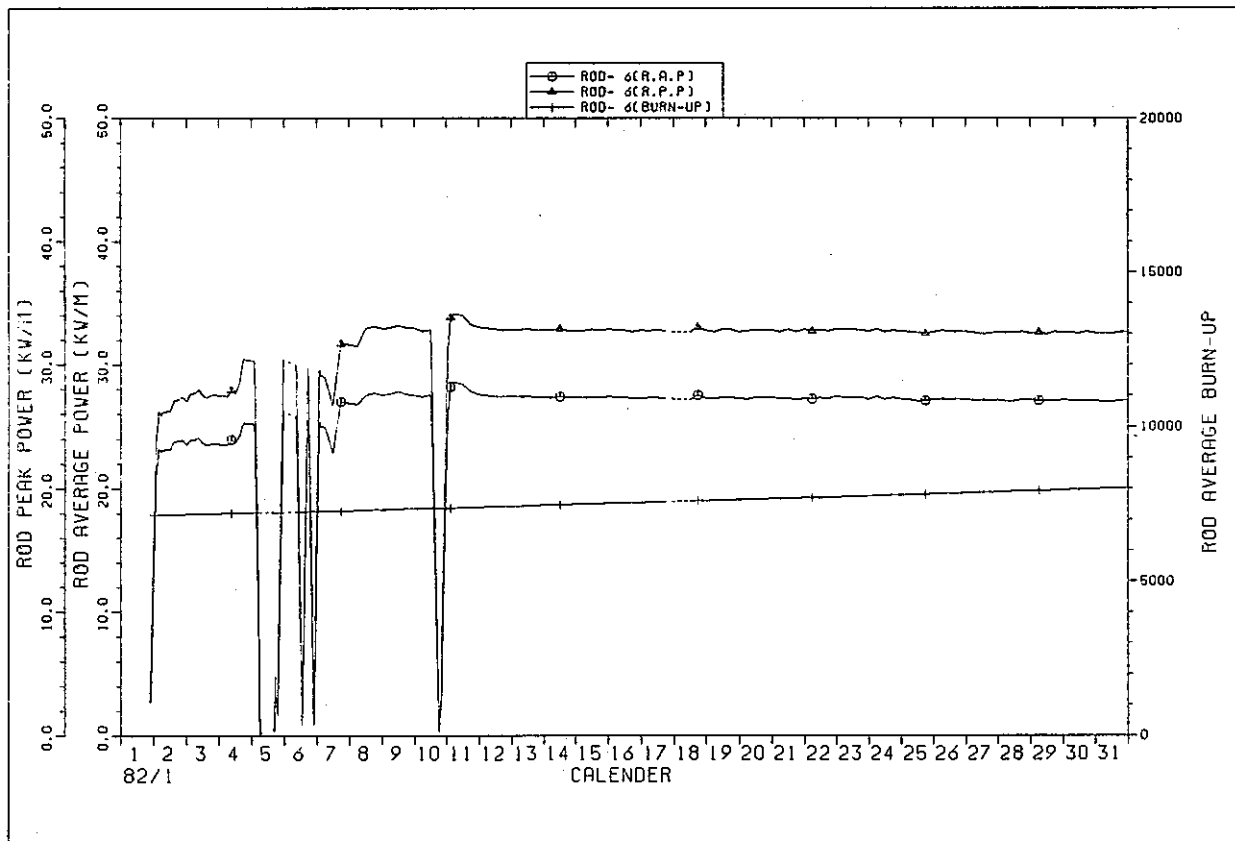

IFA529 ROD POWER HISTORY

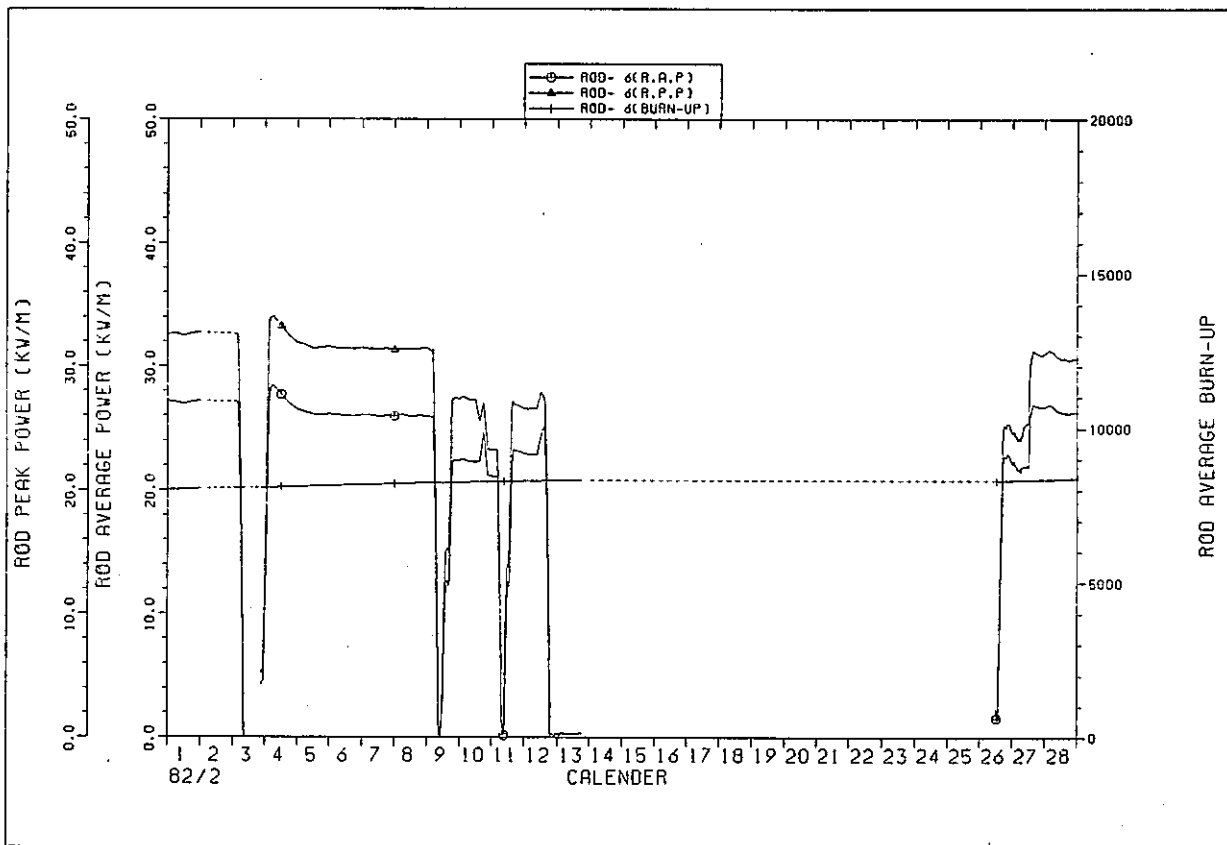

IFA529 ROD POWER HISTORY

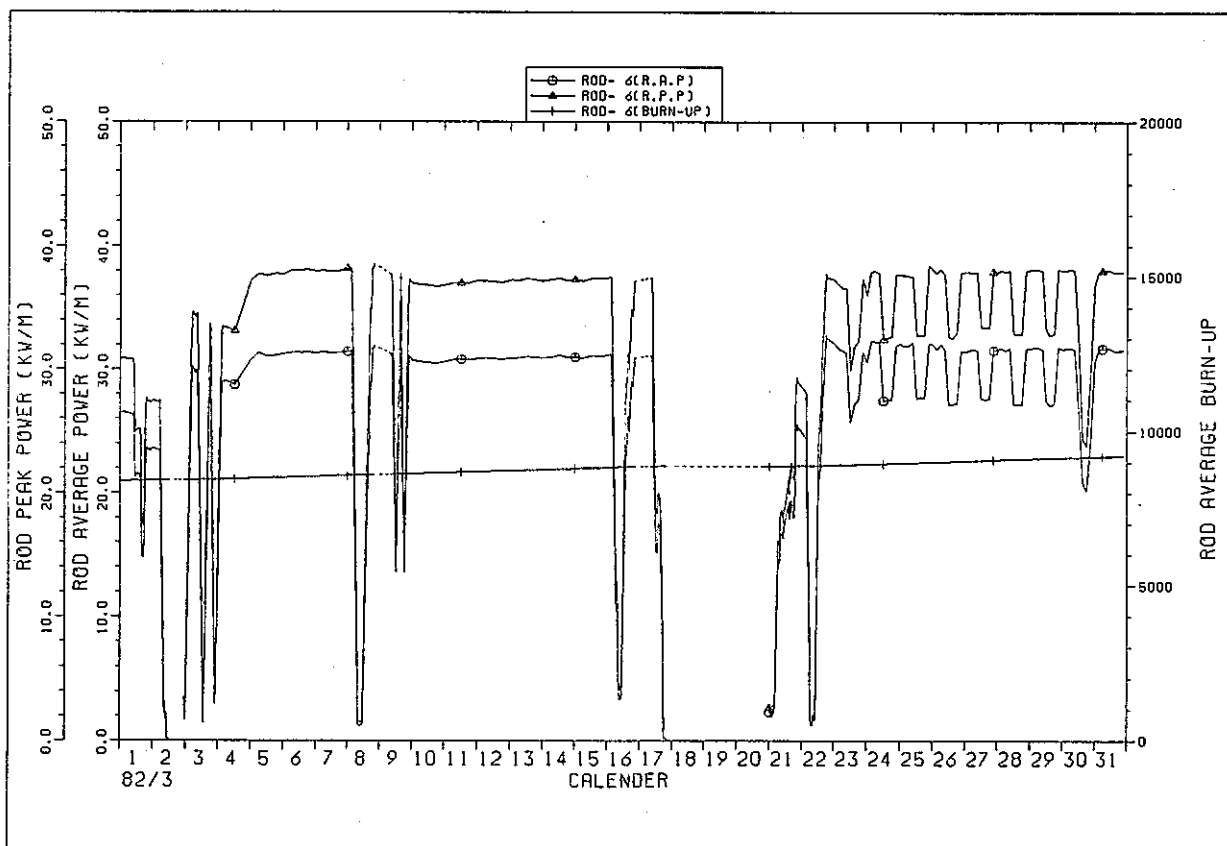

IFA529 ROD POWER HISTORY

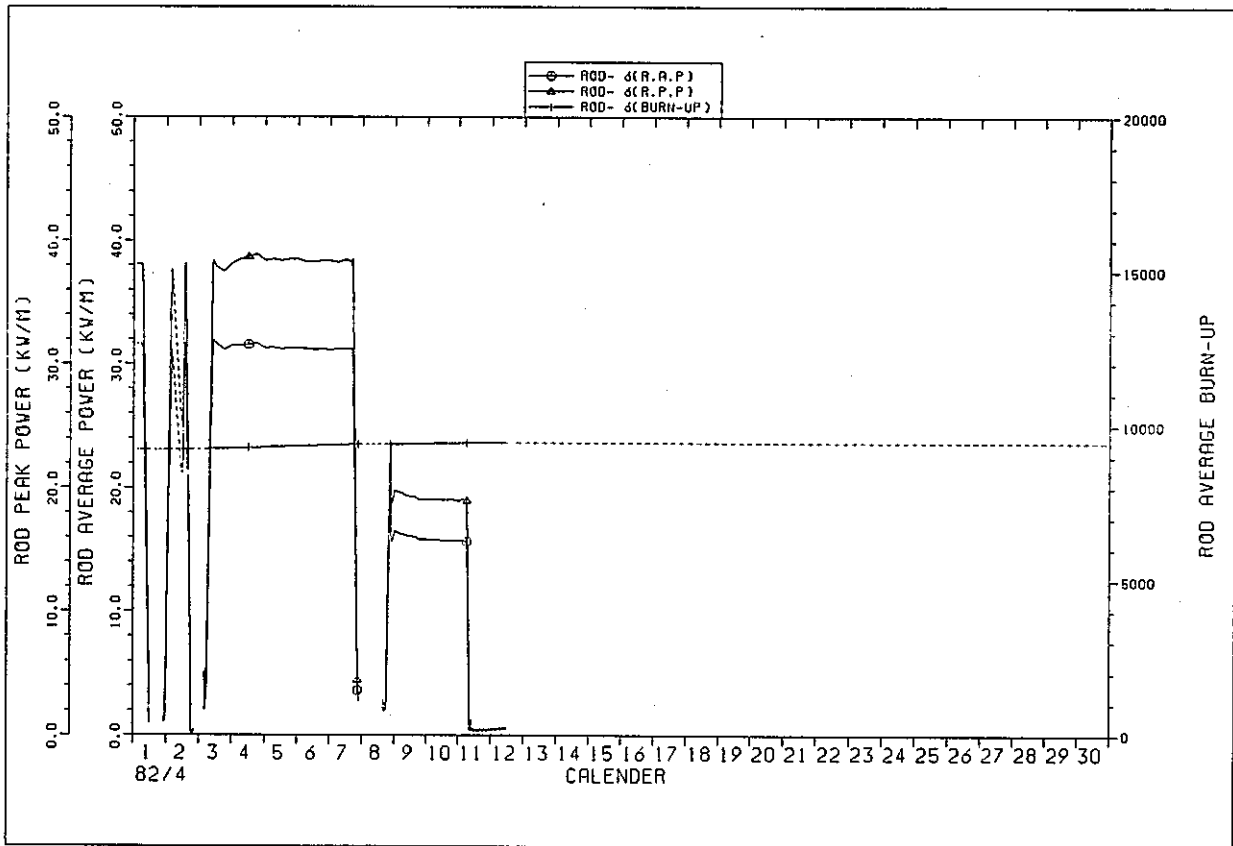

IFA529 ROD POWER HISTORY

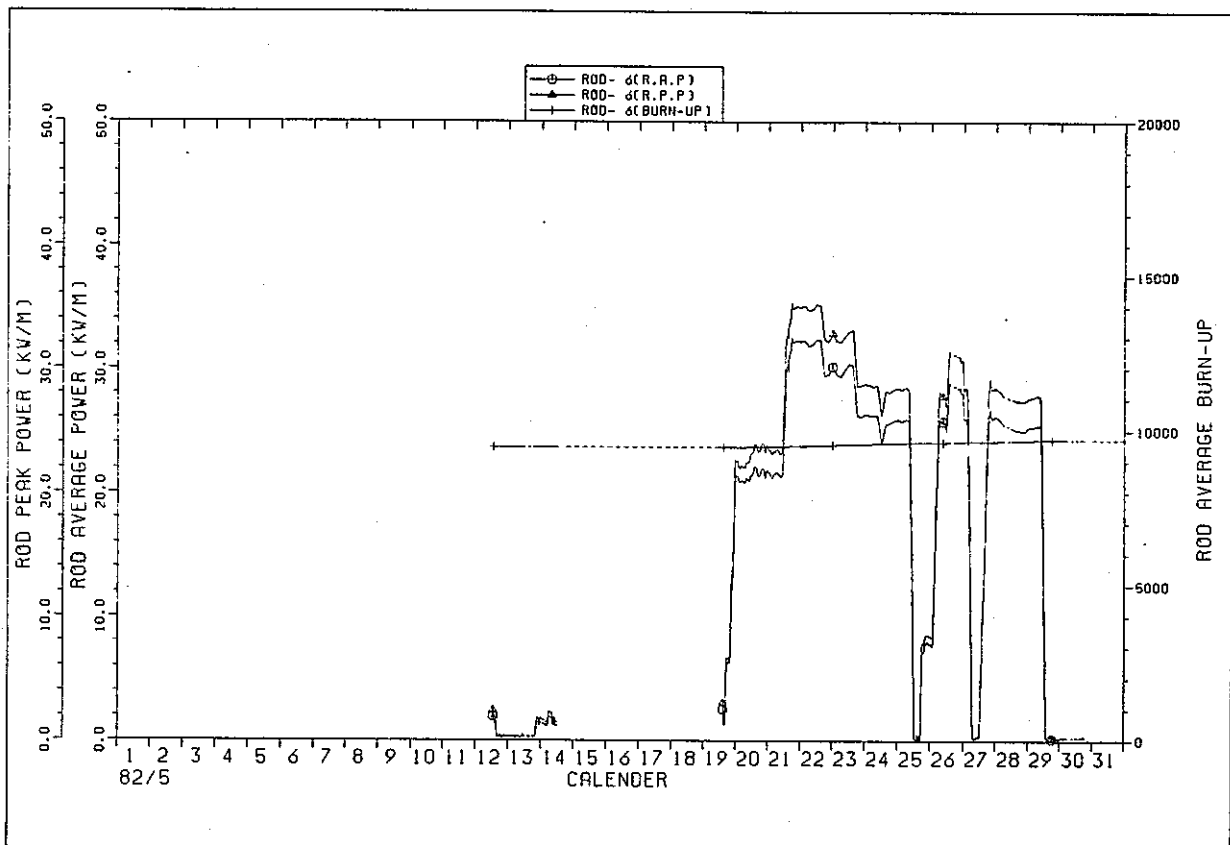

IFA529 ROD POWER HISTORY

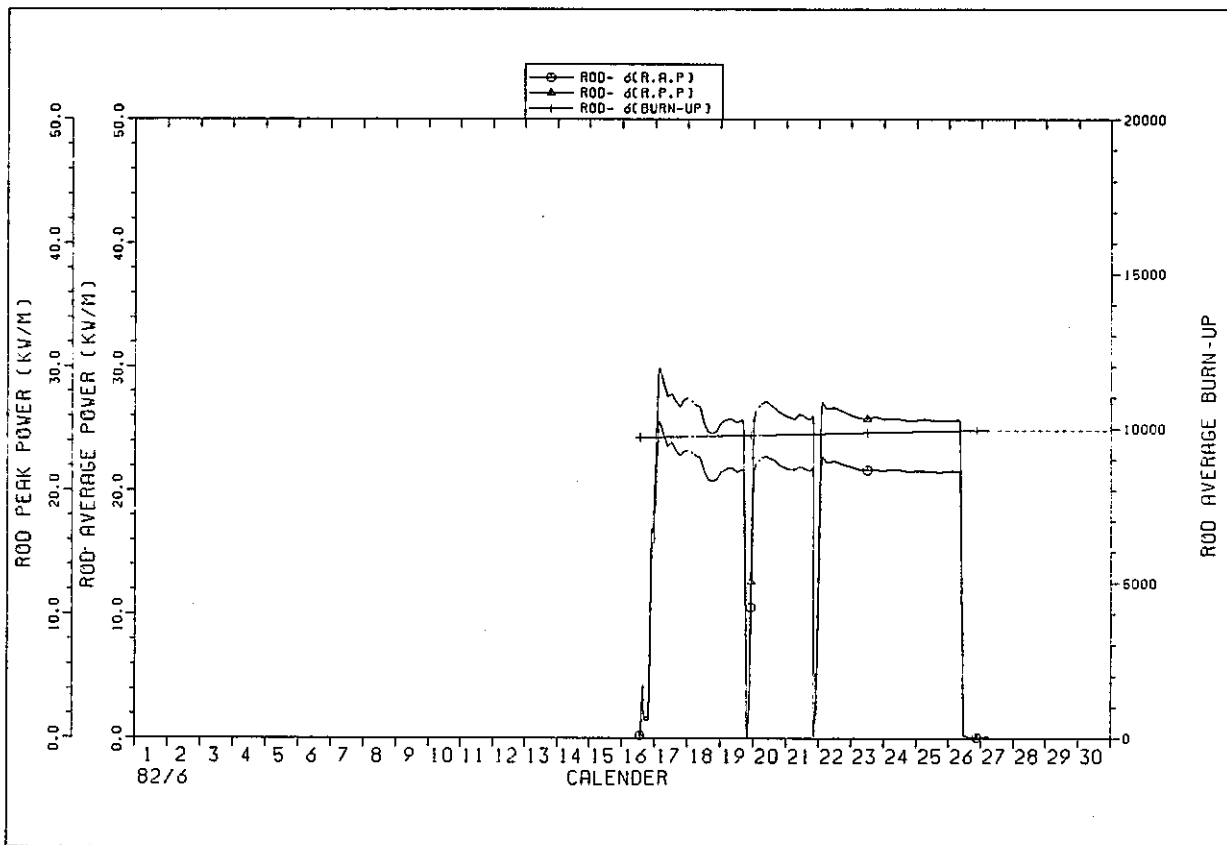

IFA529 ROD POWER HISTORY

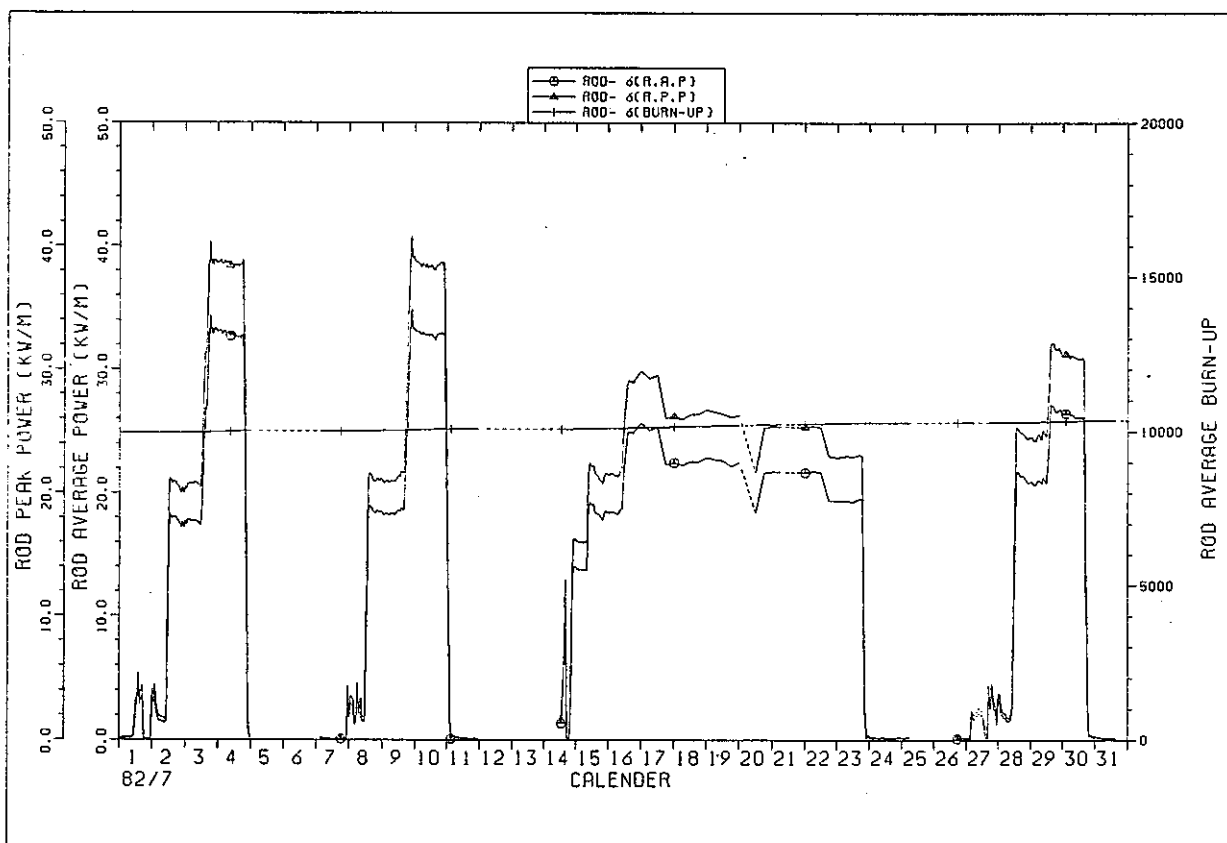

IFA529 ROD POWER HISTORY

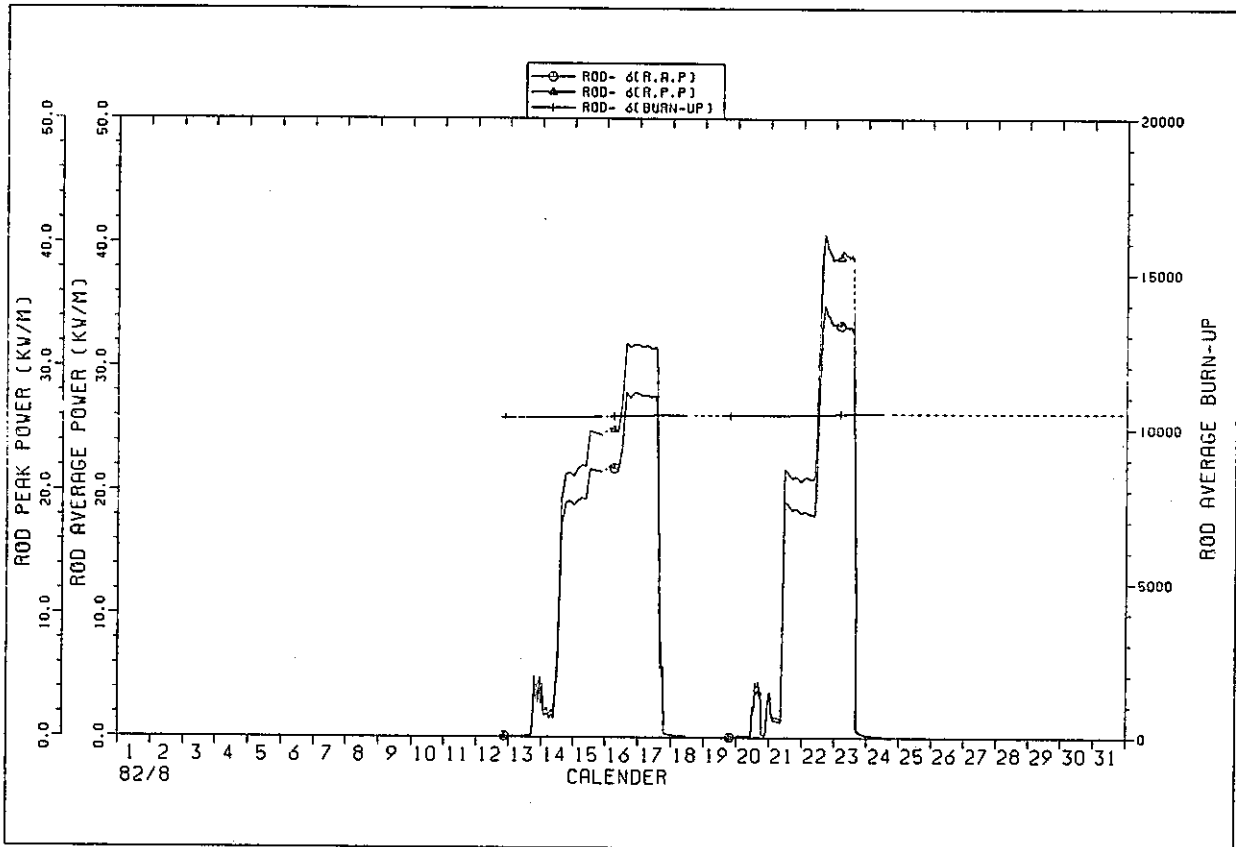

IFA529 ROD POWER HISTORY

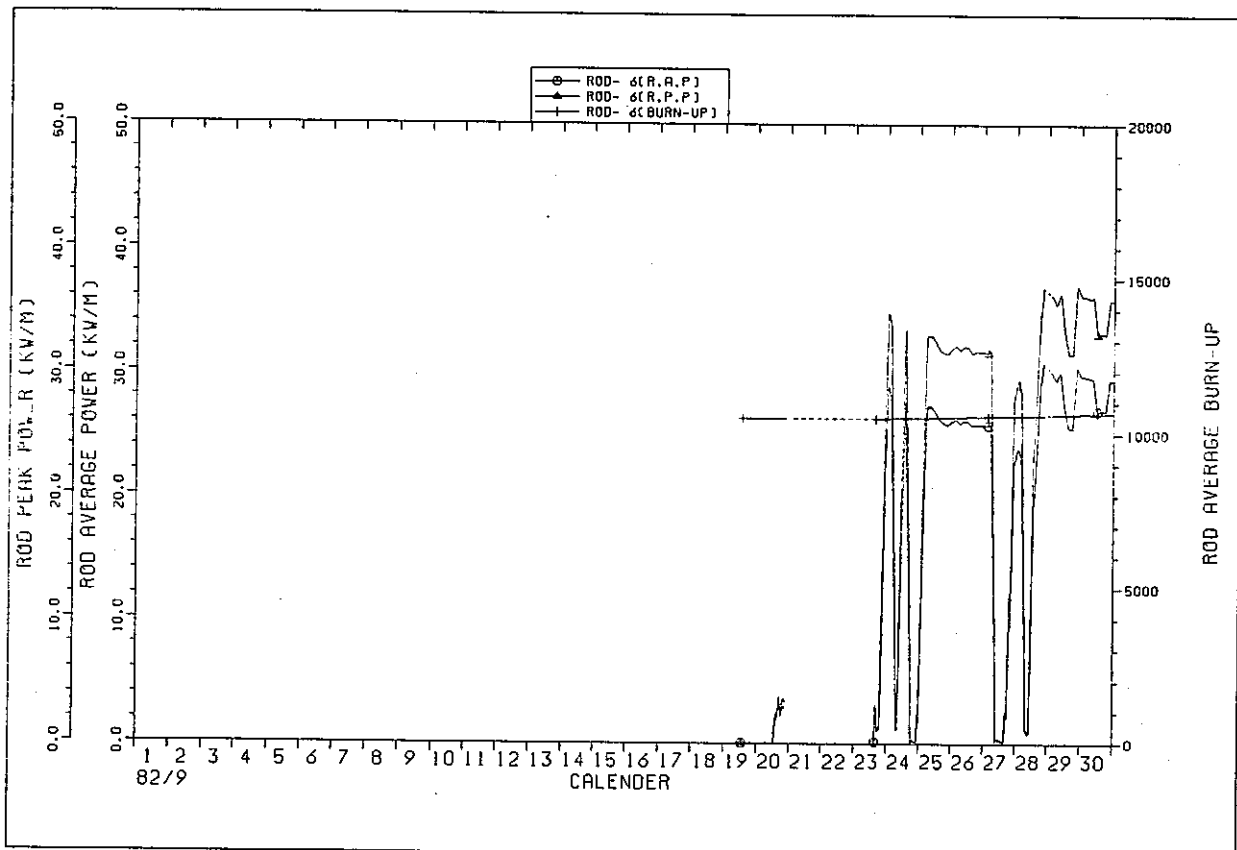

IFA529 ROD POWER HISTORY

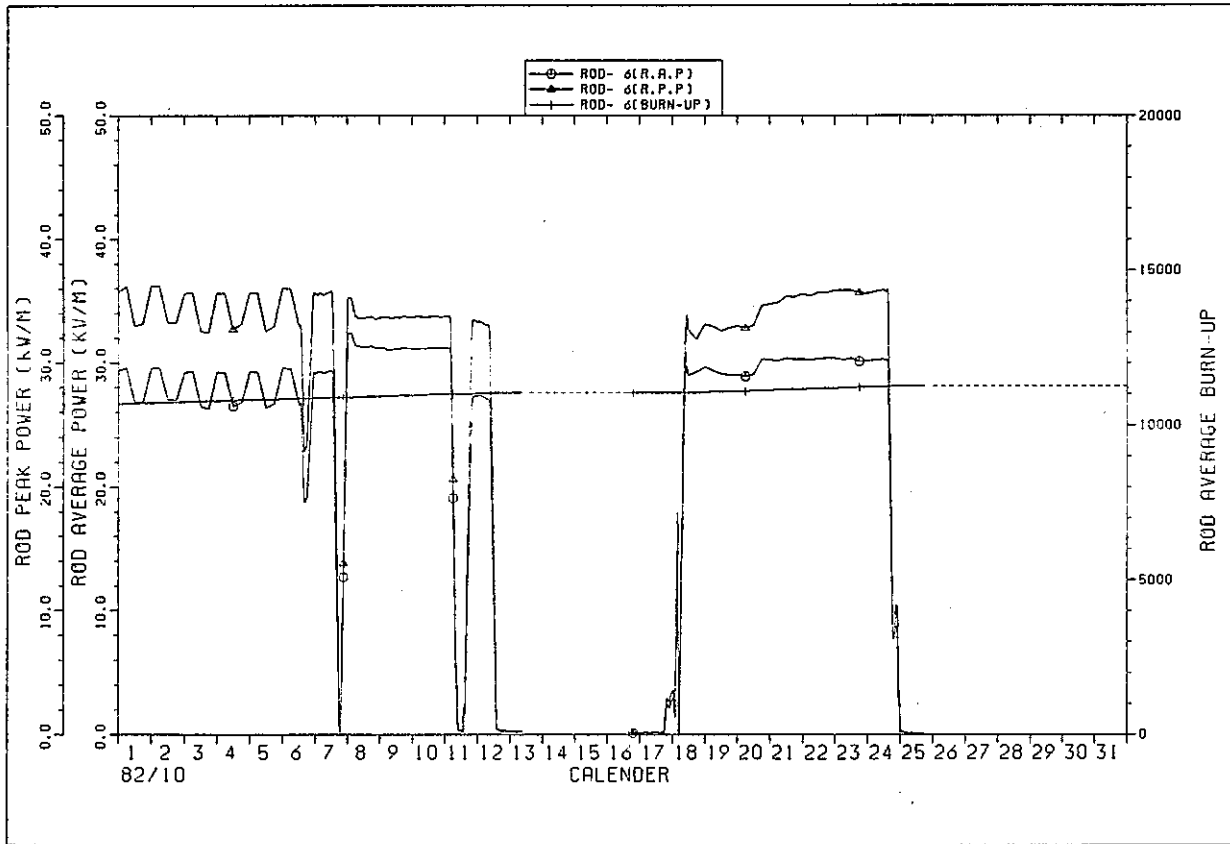

IFA529 ROD POWER HISTORY

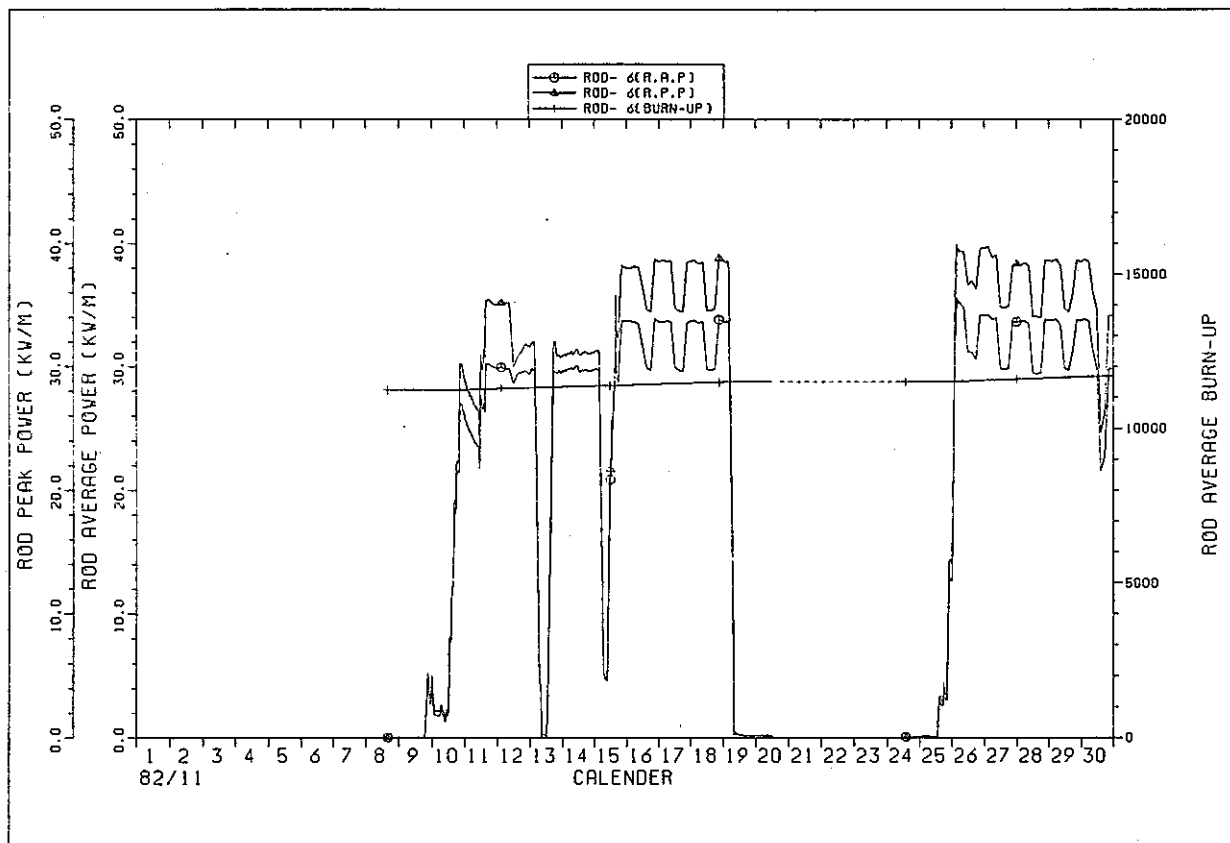

IFA529 ROD POWER HISTORY

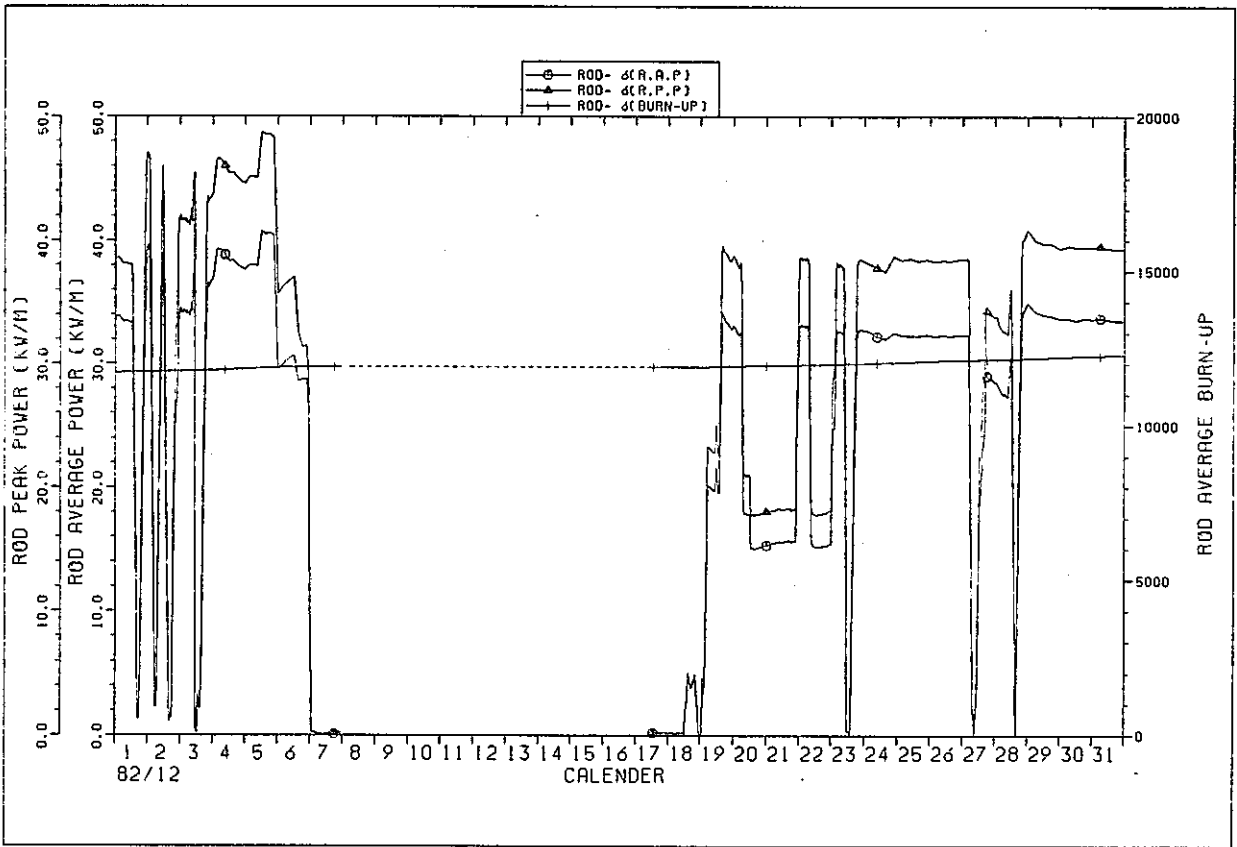

IFA529 ROD POWER HISTORY

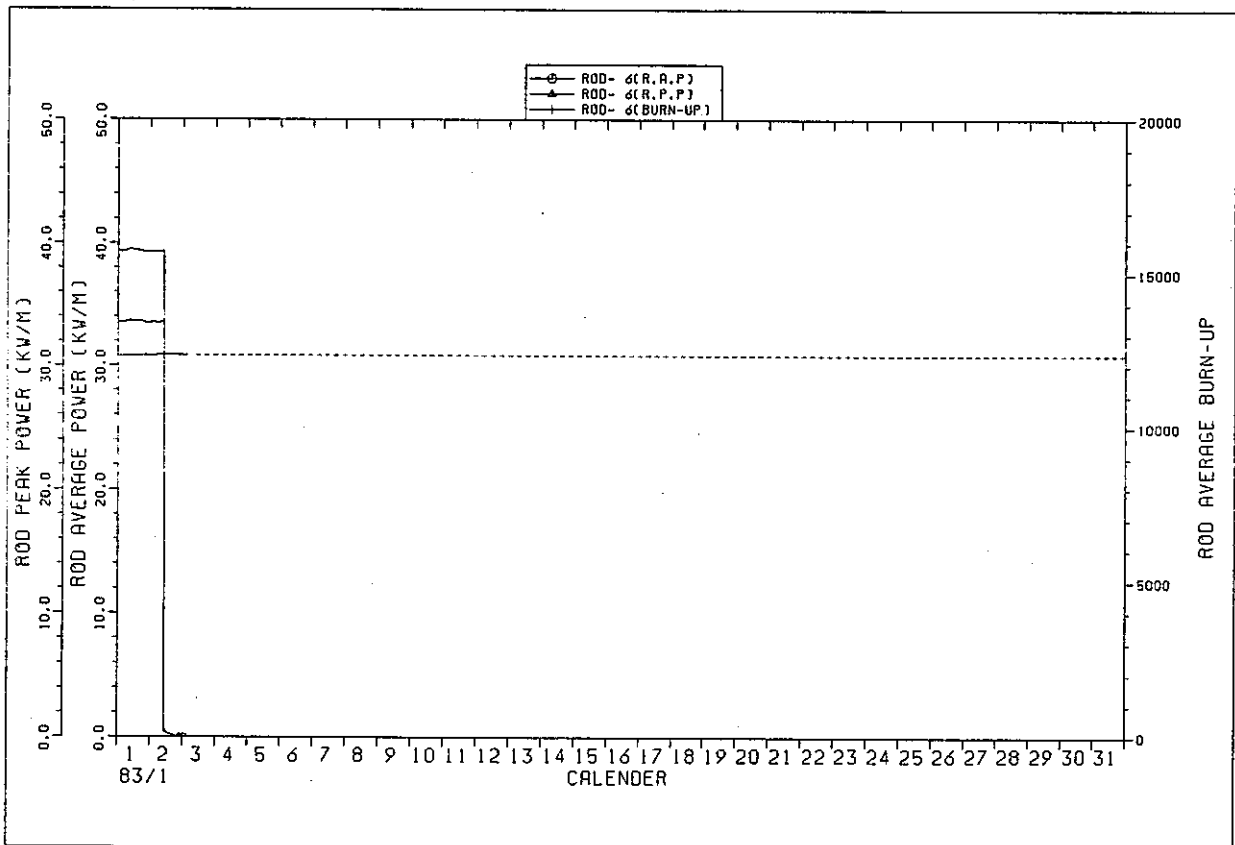

IFA529 ROD POWER HISTORY

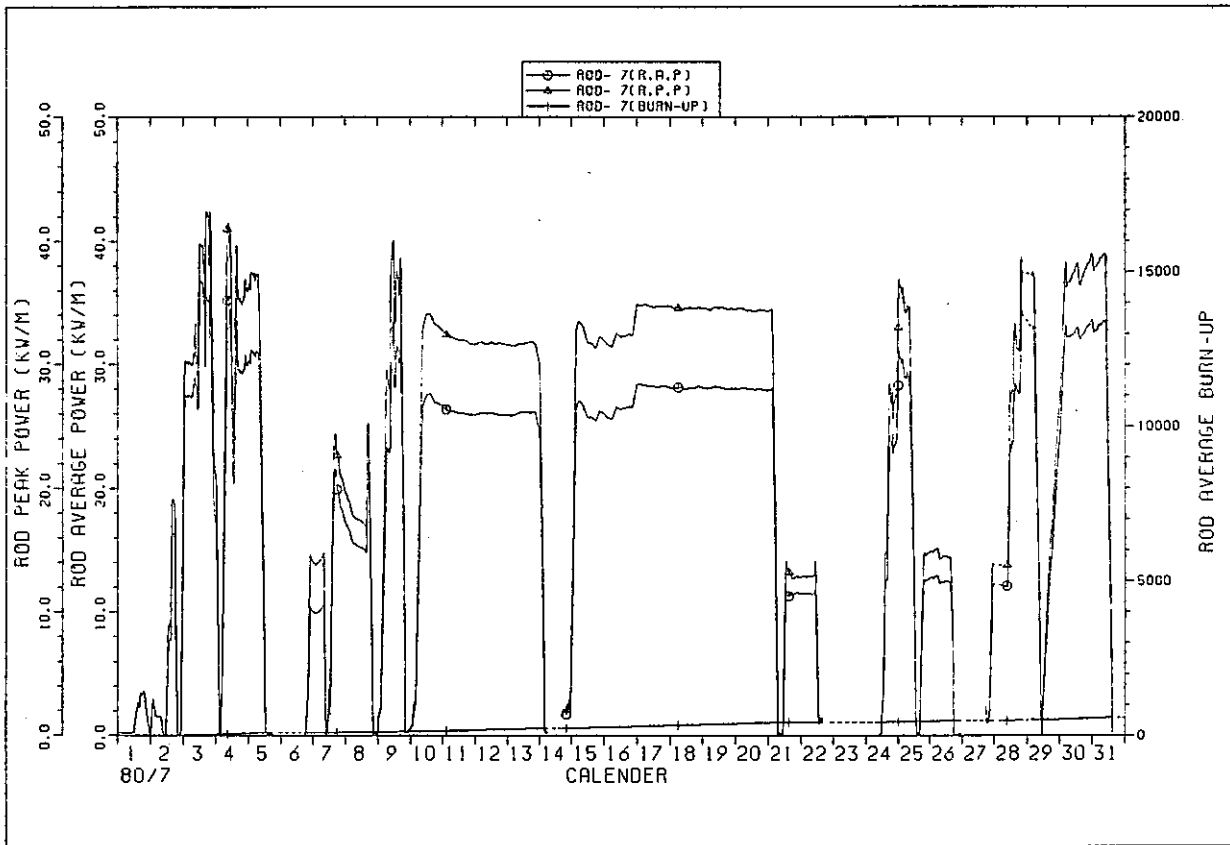

IFA529 ROD POWER HISTORY

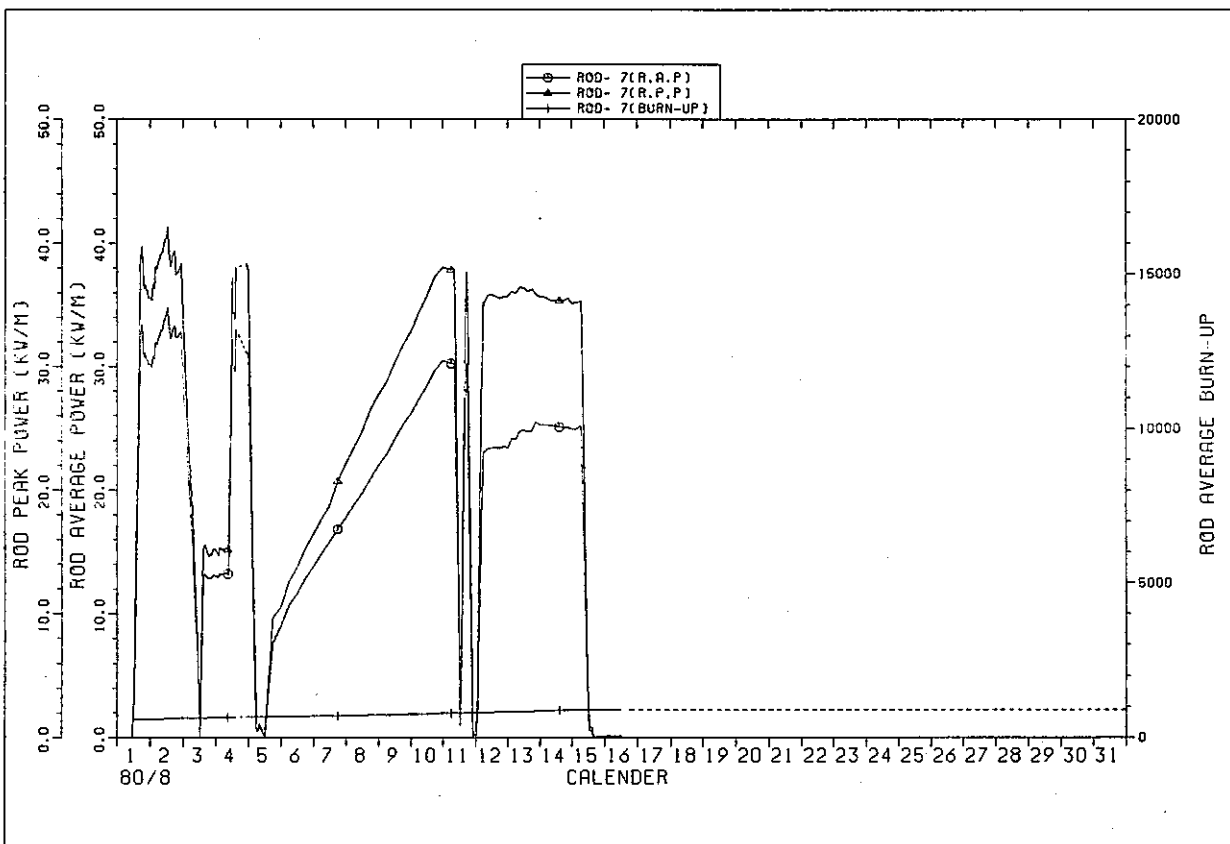

IFA529 ROD POWER HISTORY

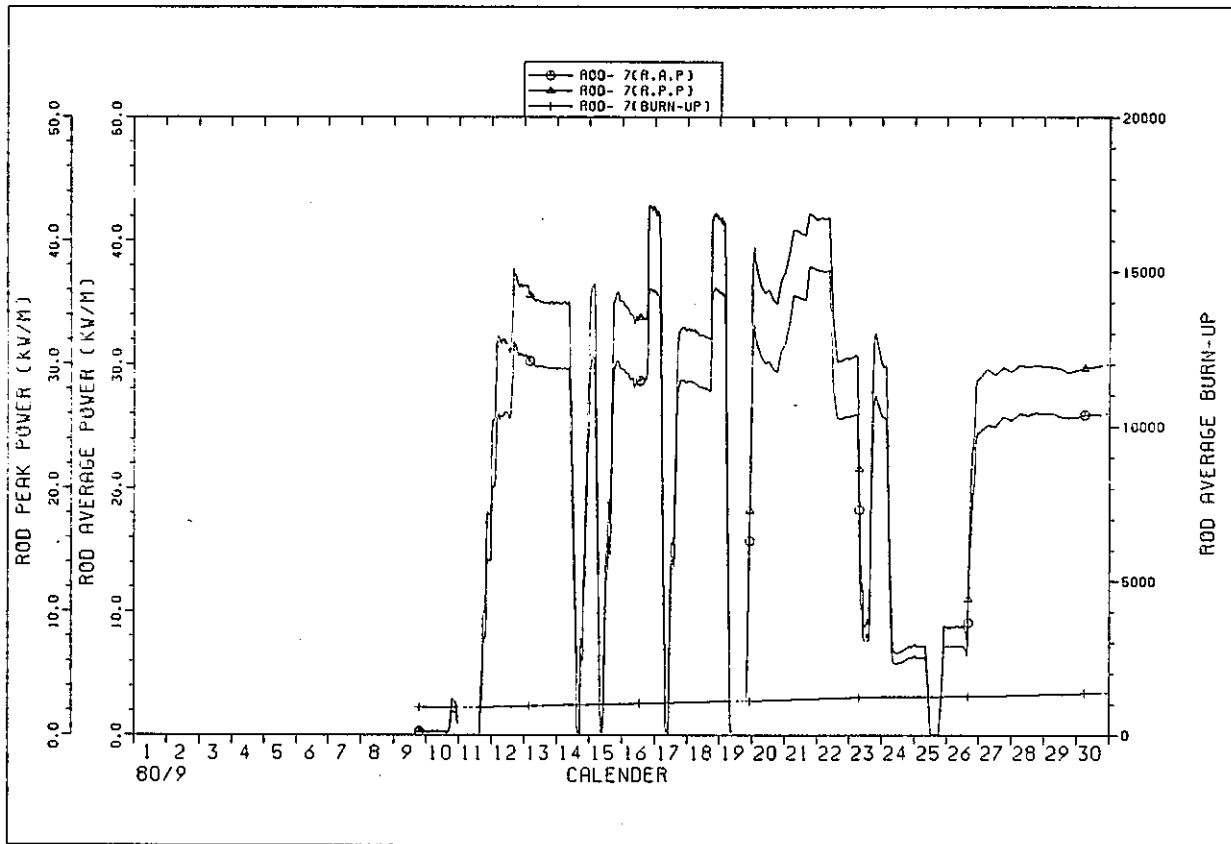

IF A529 ROD POWER HISTORY

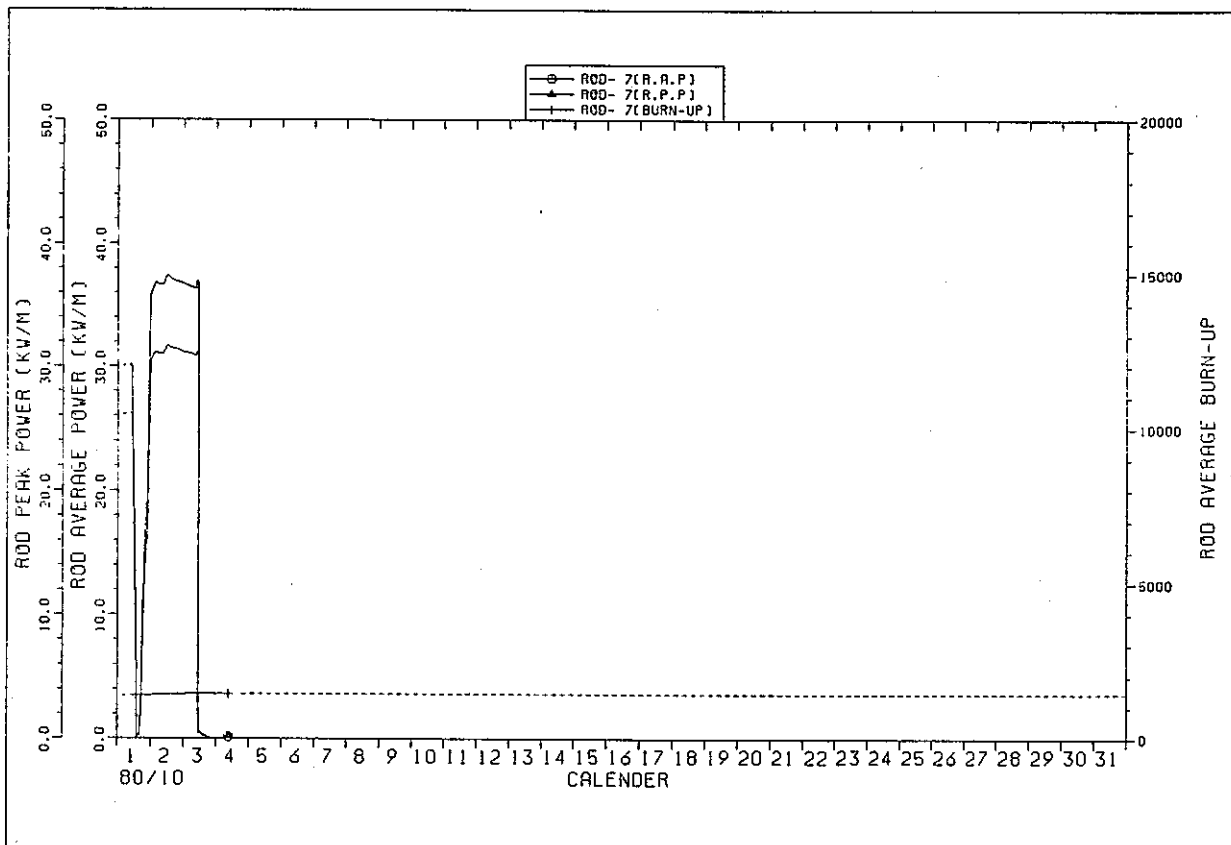

IF A529 ROD POWER HISTORY

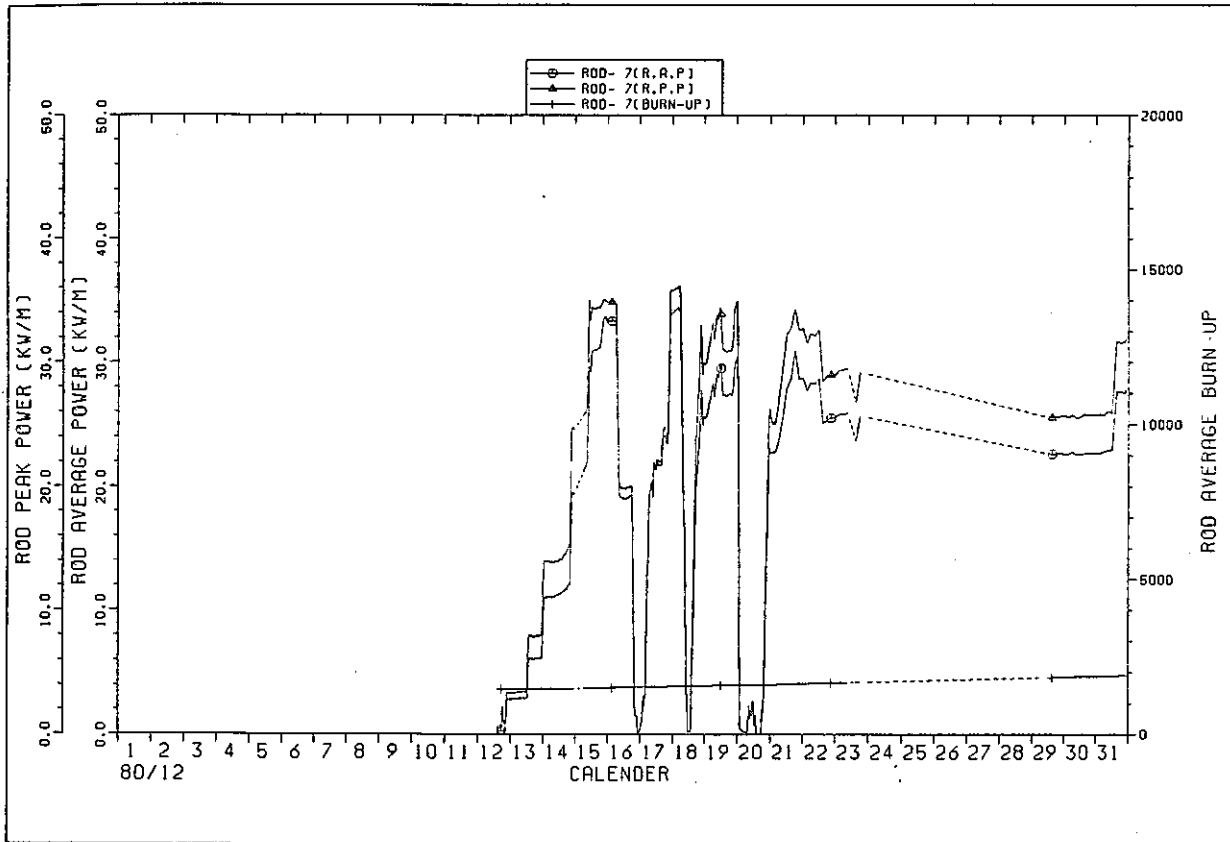

IFA529 ROD POWER HISTORY

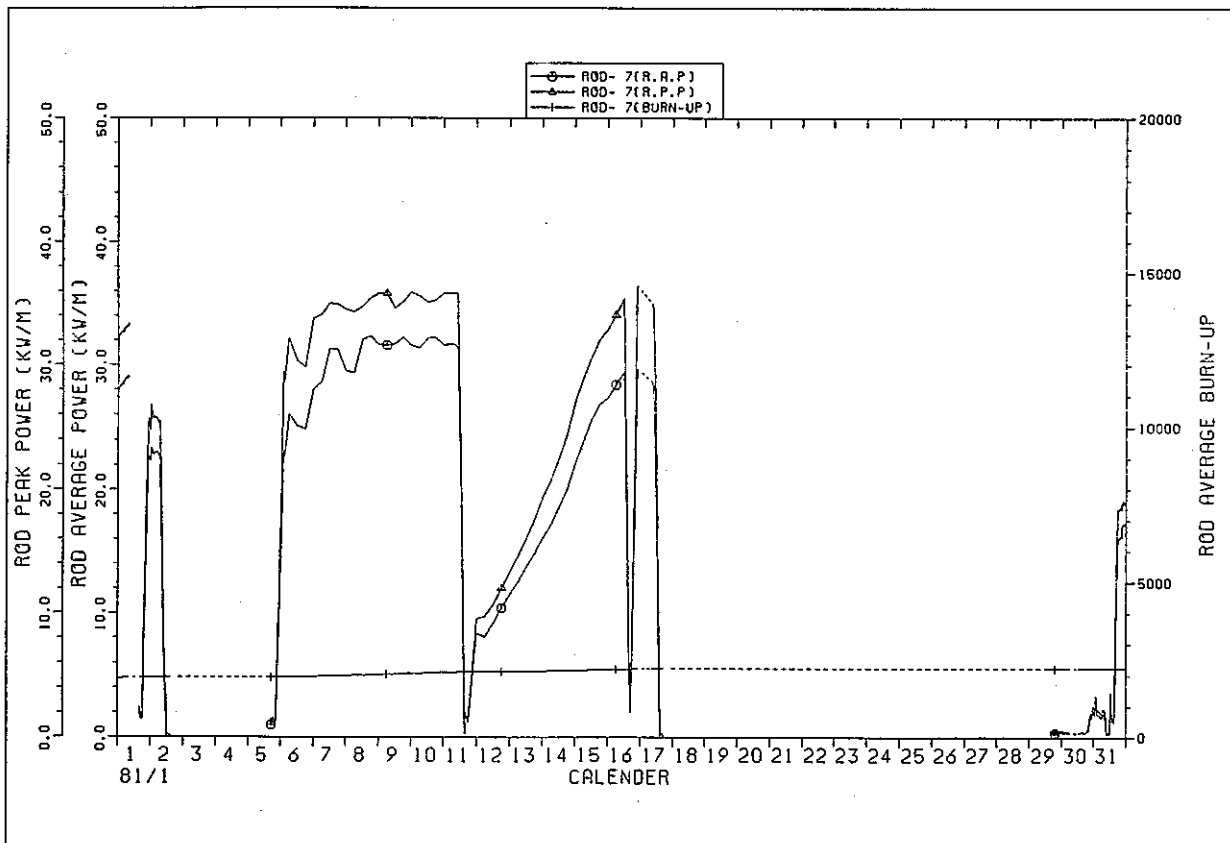

IFA529 ROD POWER HISTORY

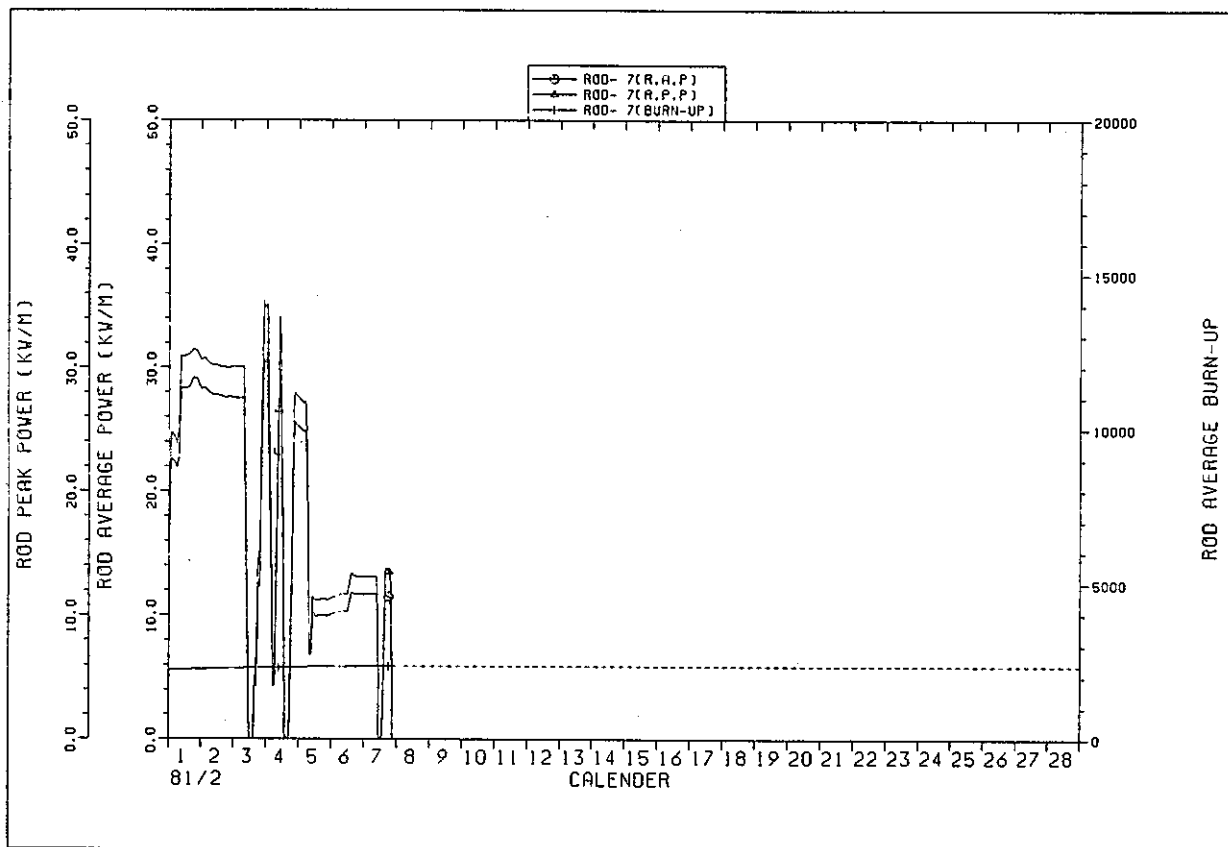

IFA529 ROD POWER HISTORY

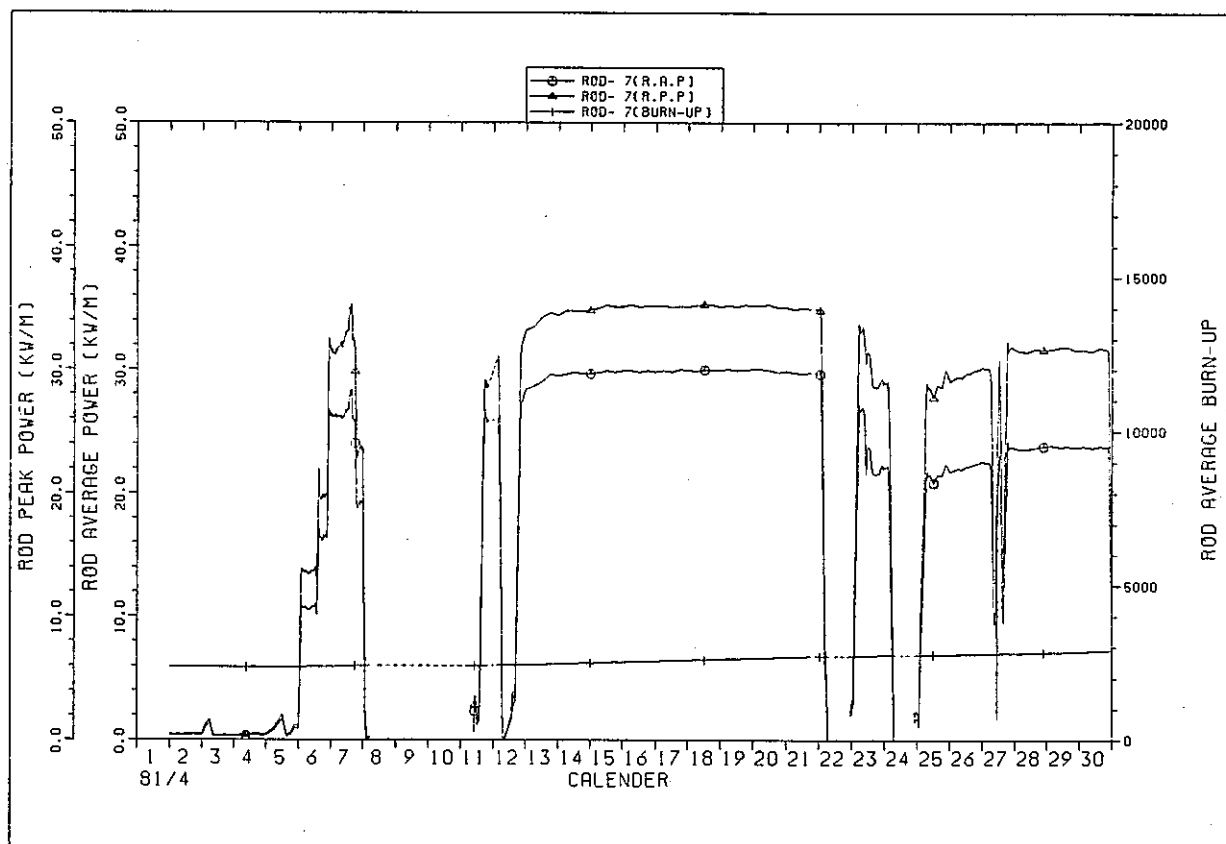

IFA529 ROD POWER HISTORY

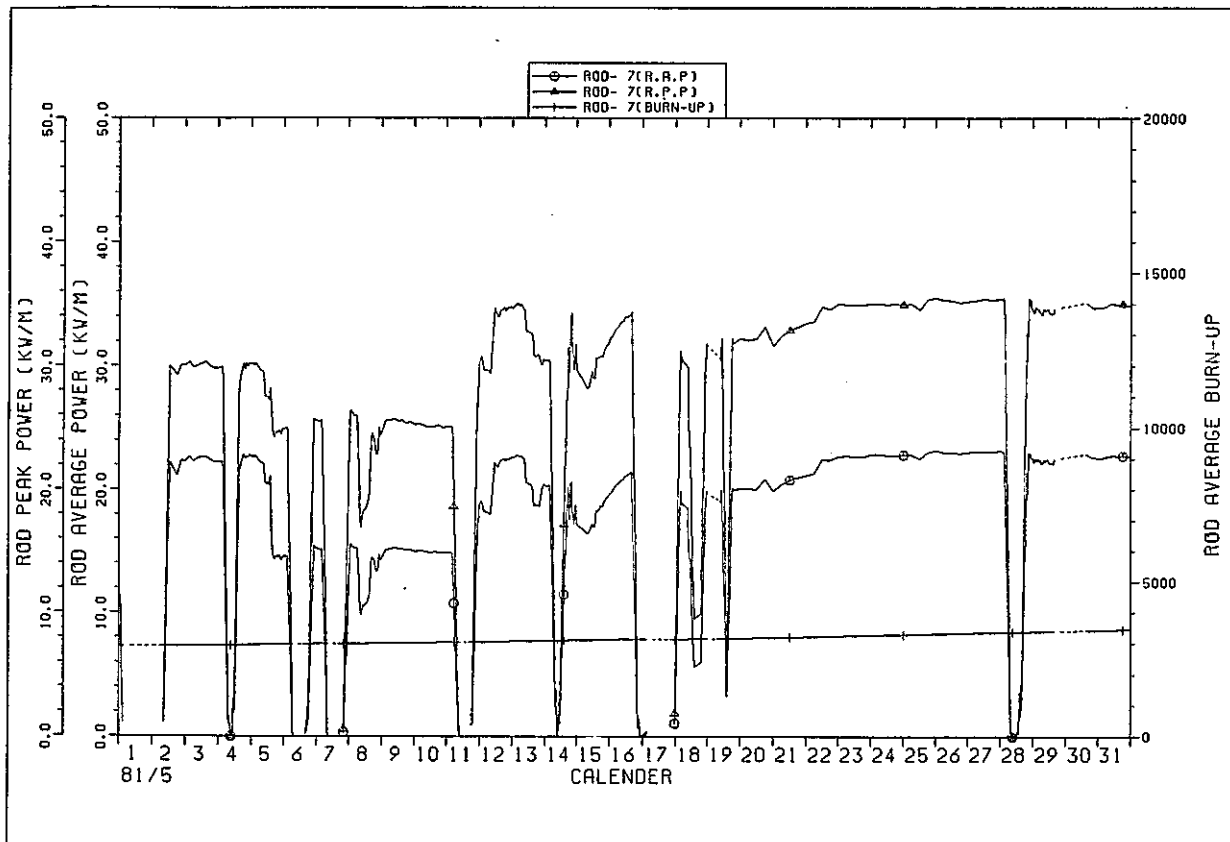

IFA529 ROD POWER HISTORY

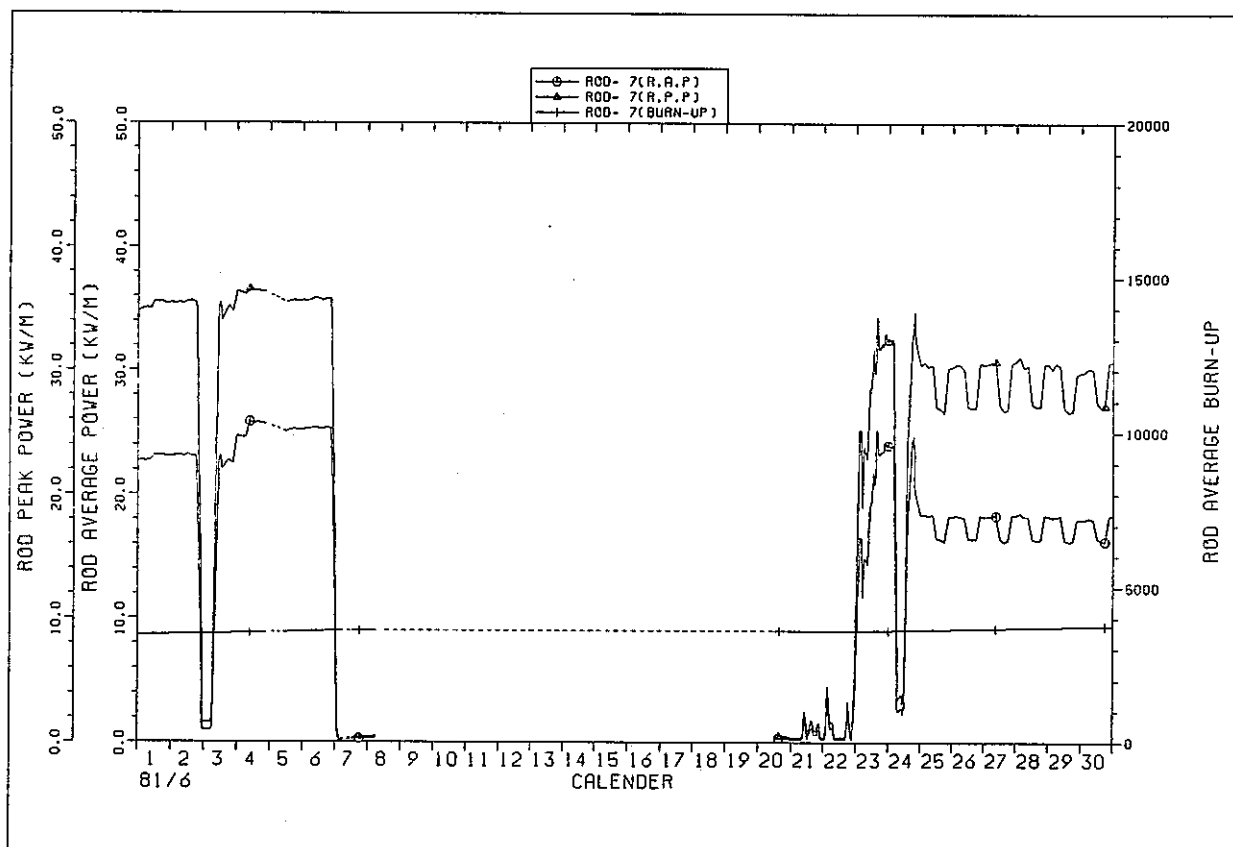

IFA529 ROD POWER HISTORY

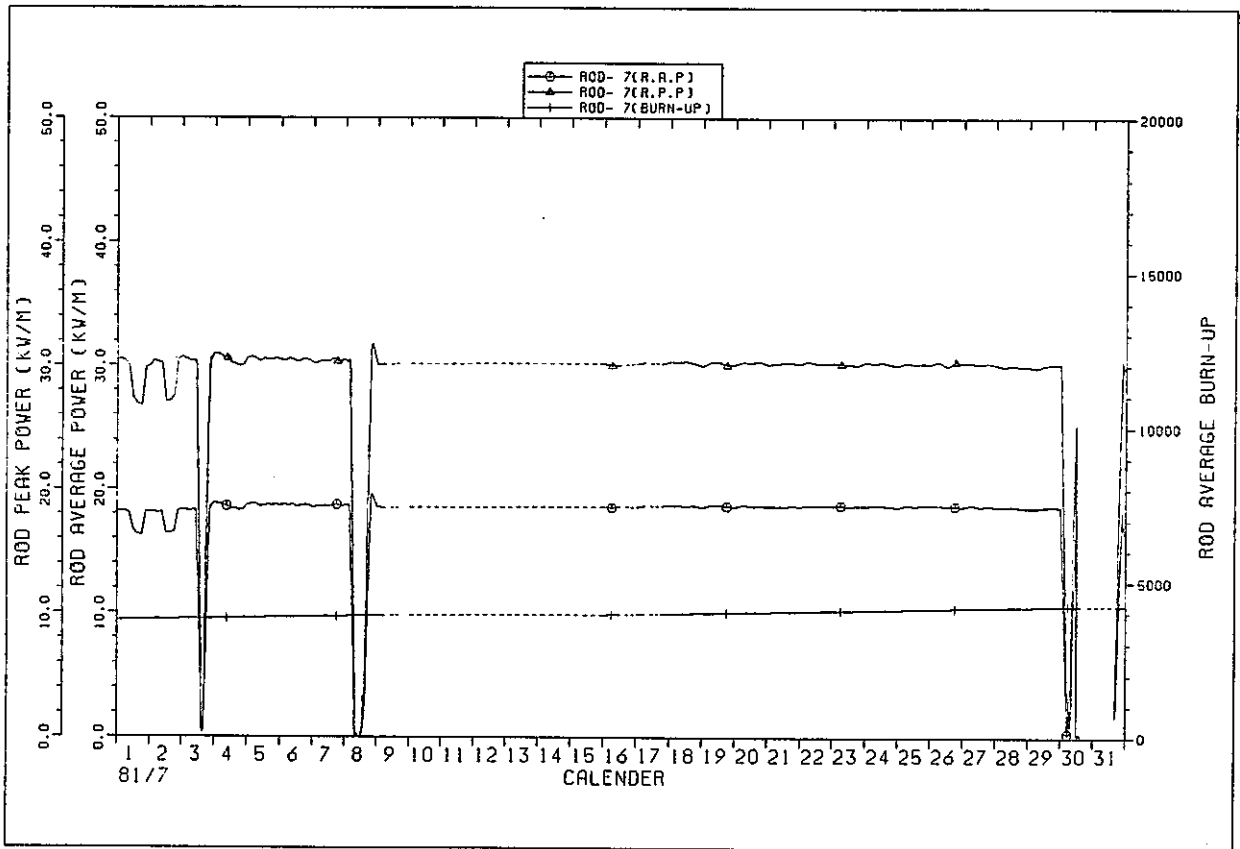

IFA529 ROD POWER HISTORY

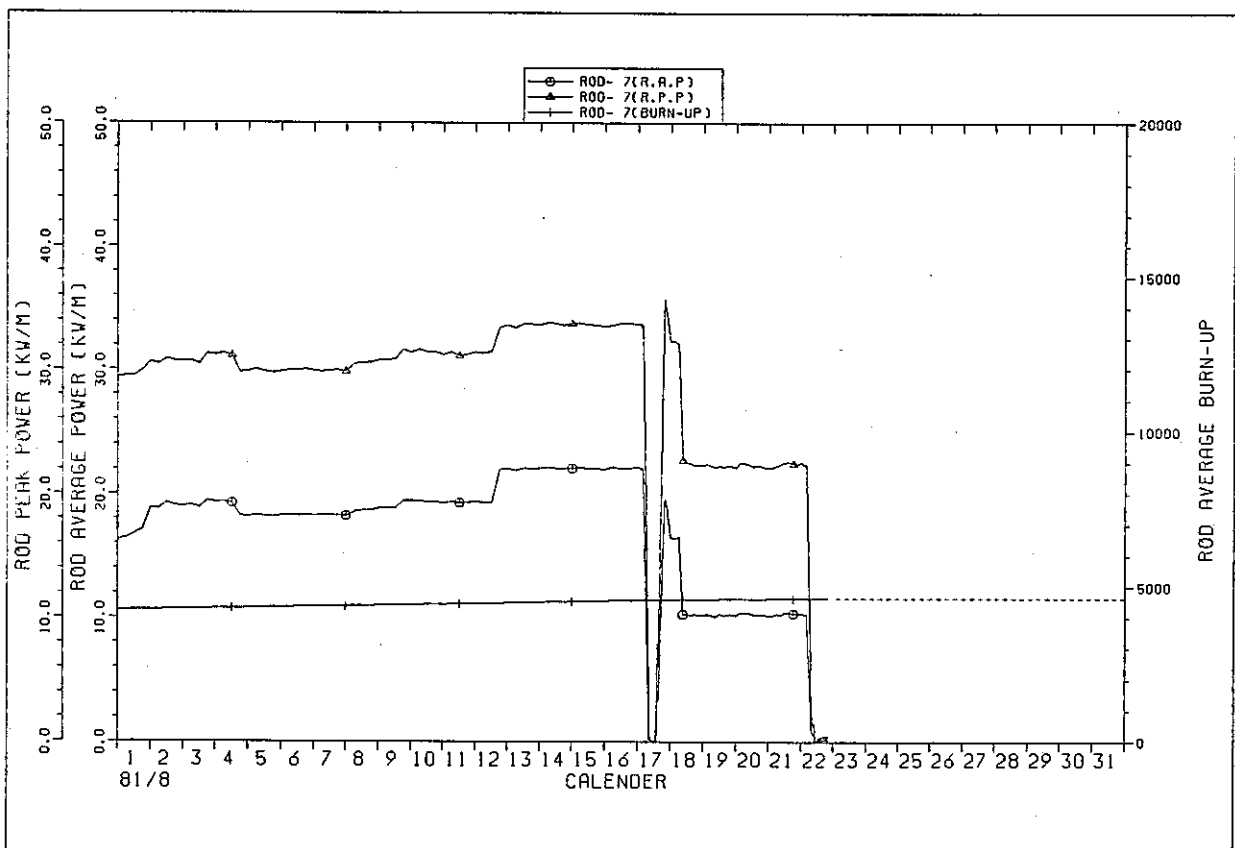

IFA529 ROD POWER HISTORY

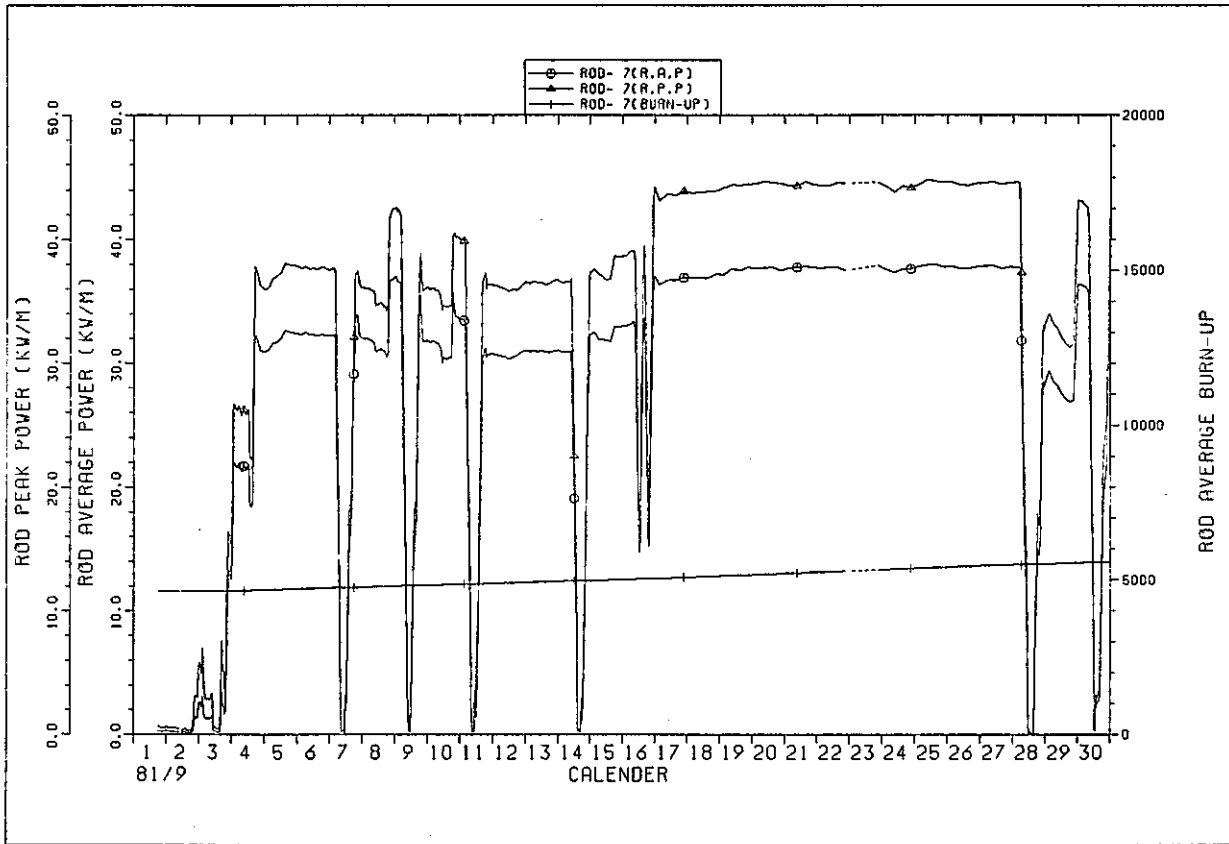

IFA529 ROD POWER HISTORY

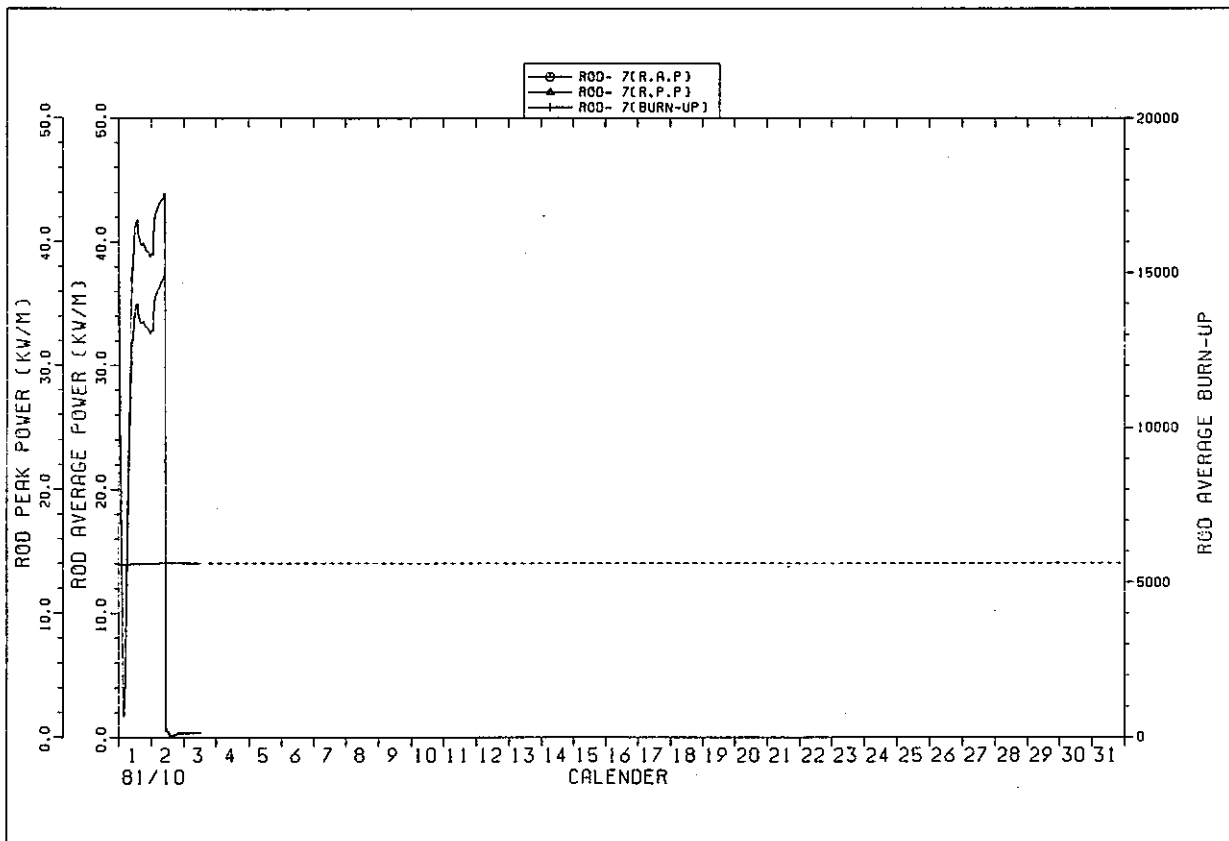

IFA529 ROD POWER HISTORY

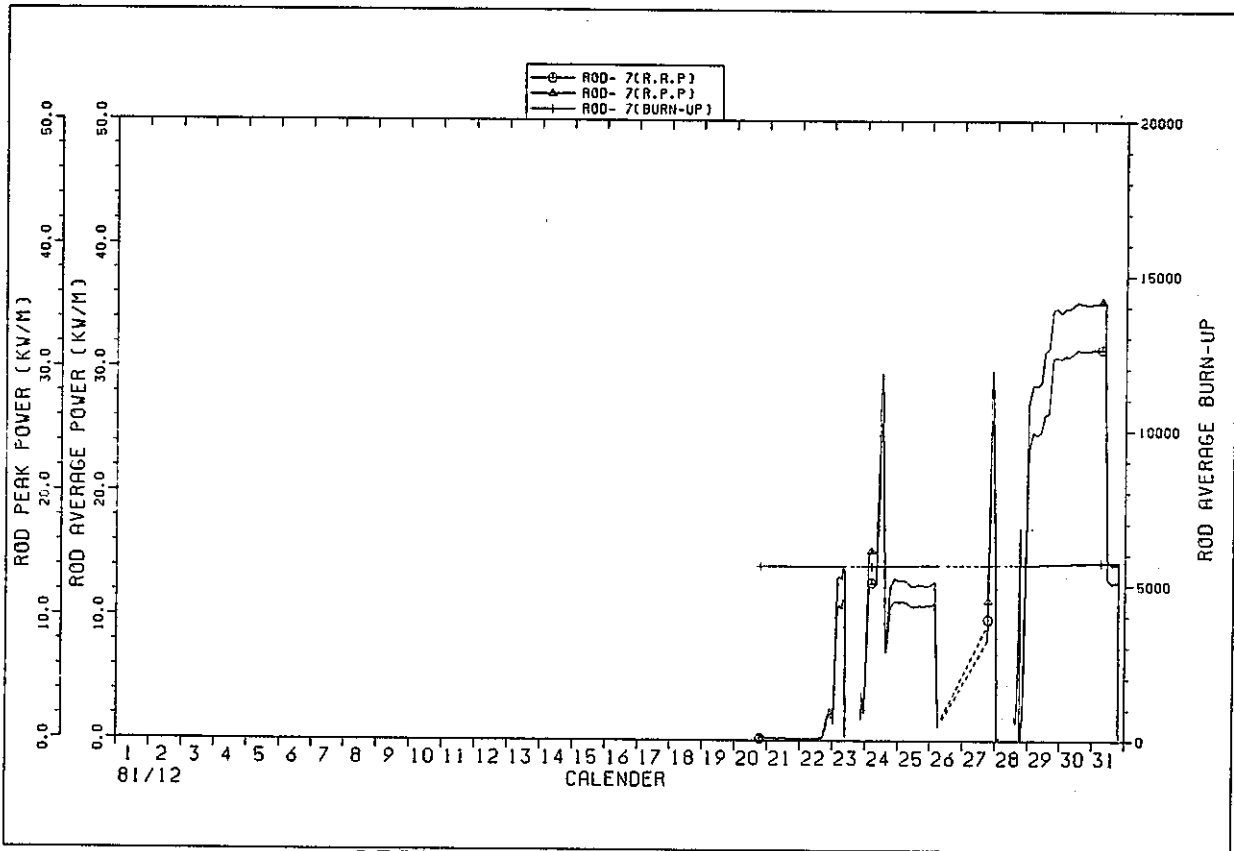

IFA529 ROD POWER HISTORY

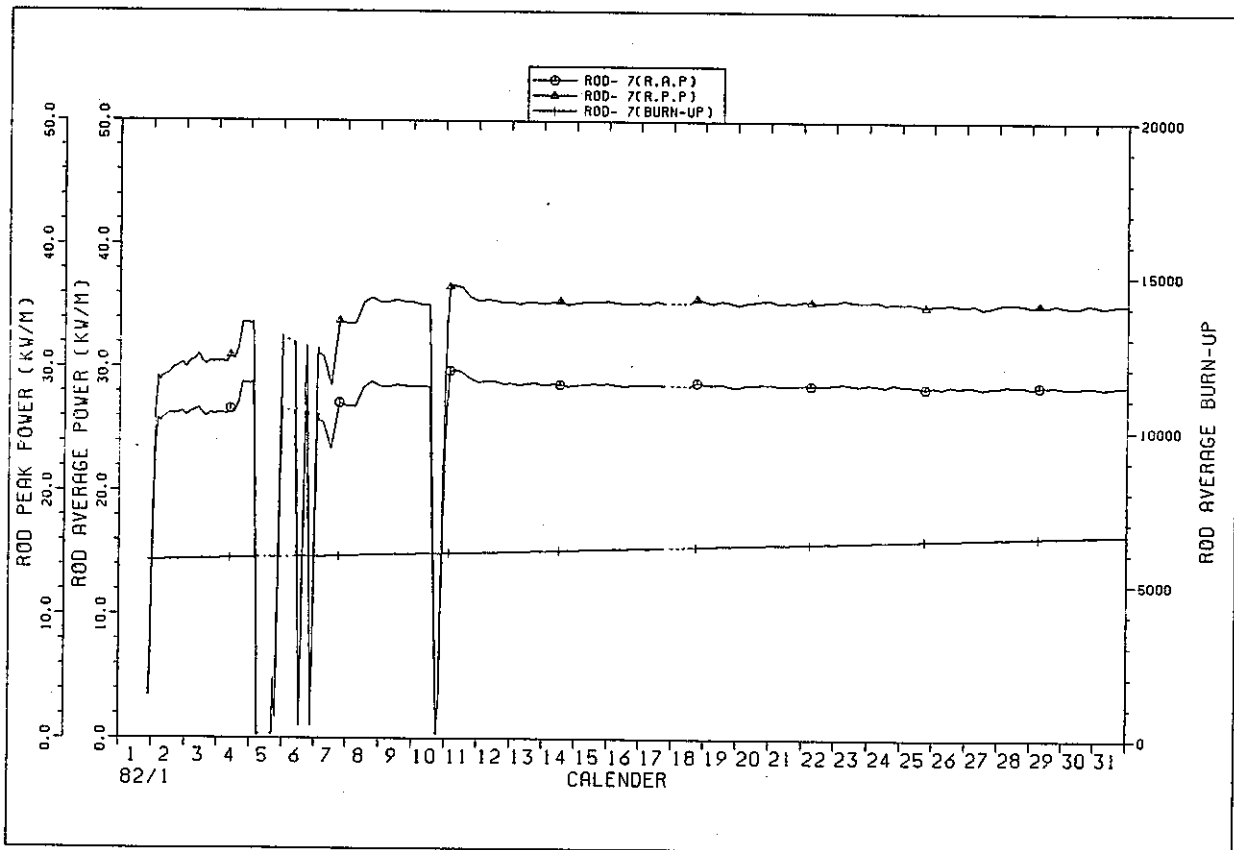

IFA529 ROD POWER HISTORY

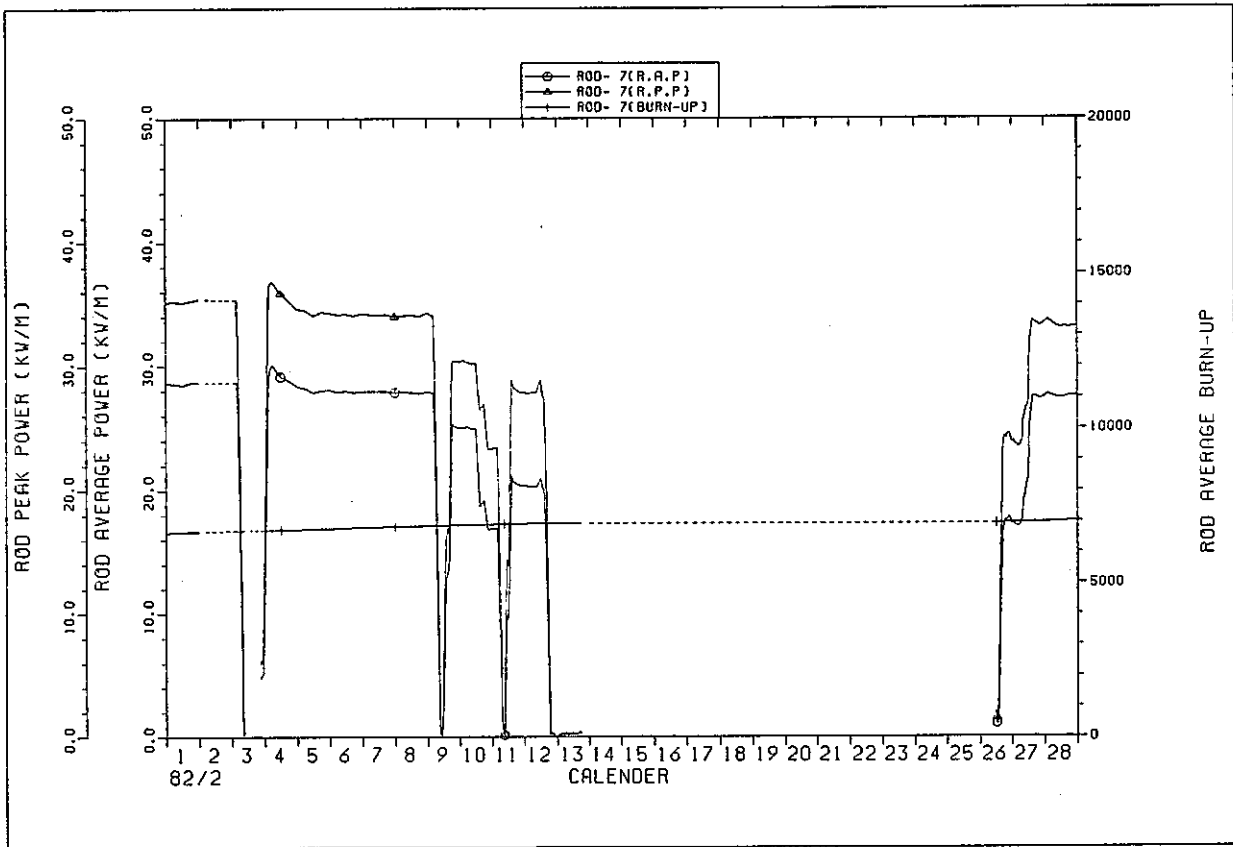

IFA529 ROD POWER HISTORY

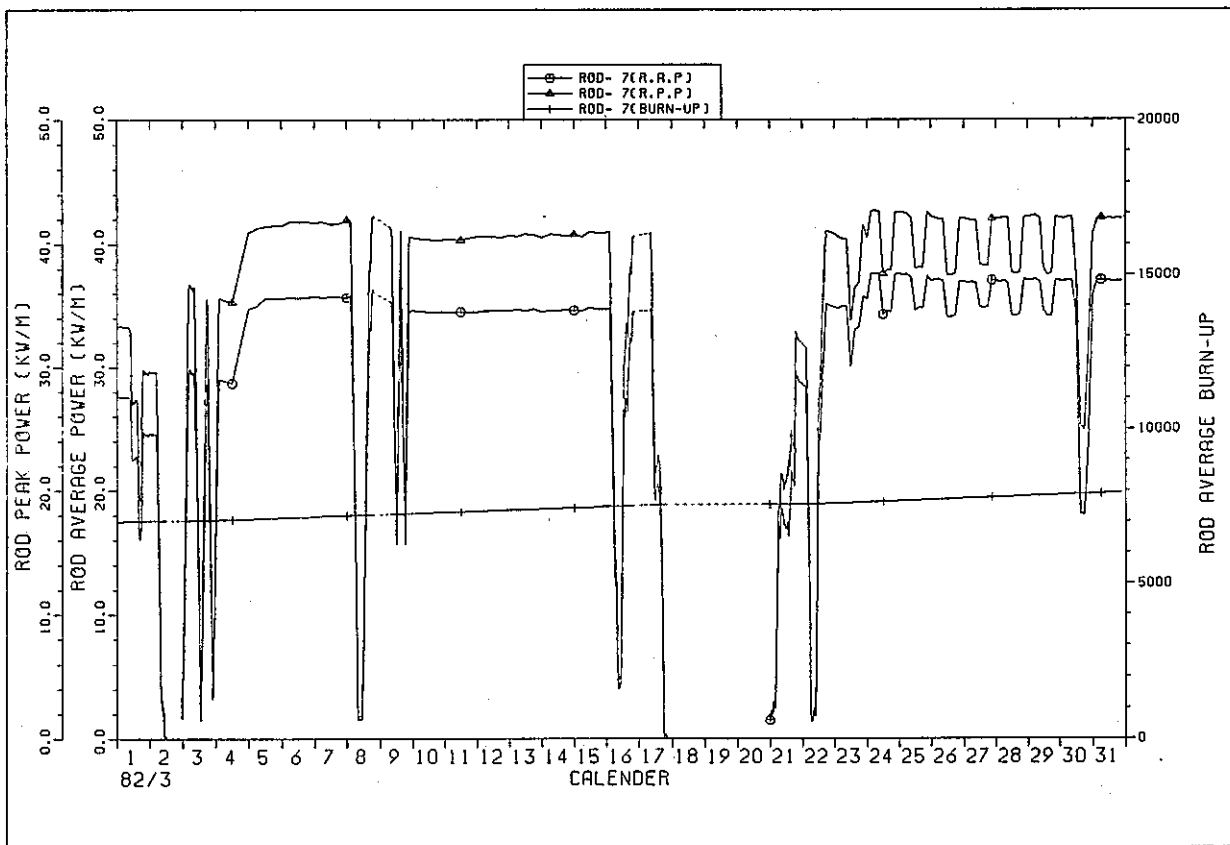

IFA529 ROD POWER HISTORY

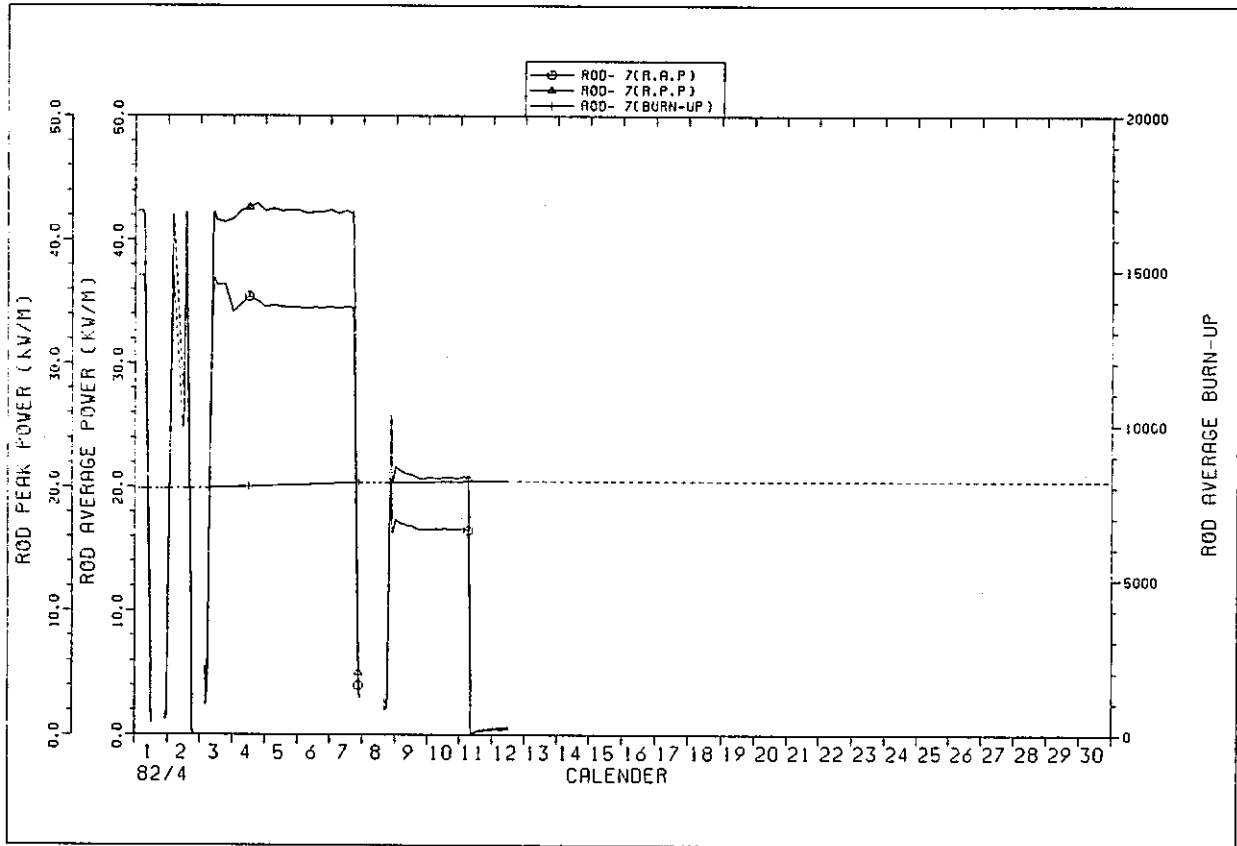

IFA529 ROD POWER HISTORY

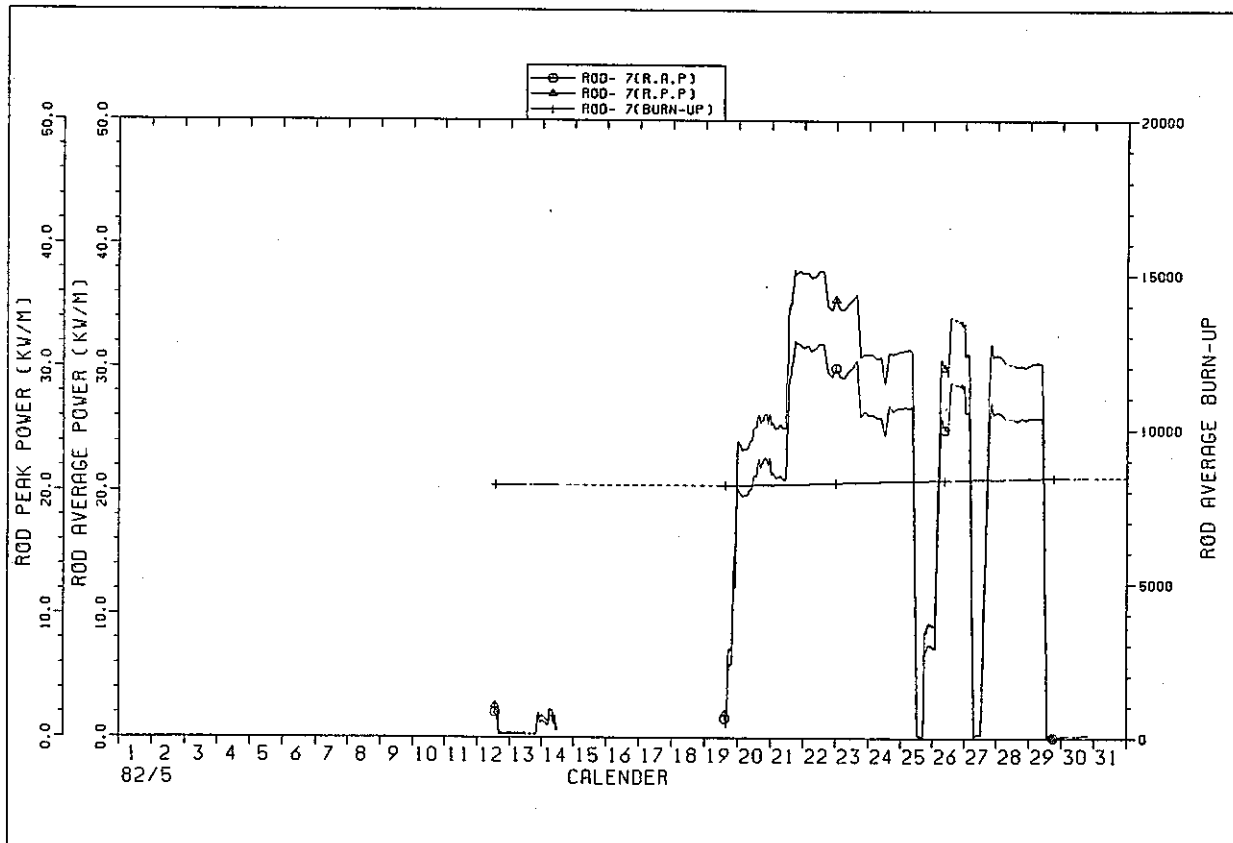

IFA529 ROD POWER HISTORY

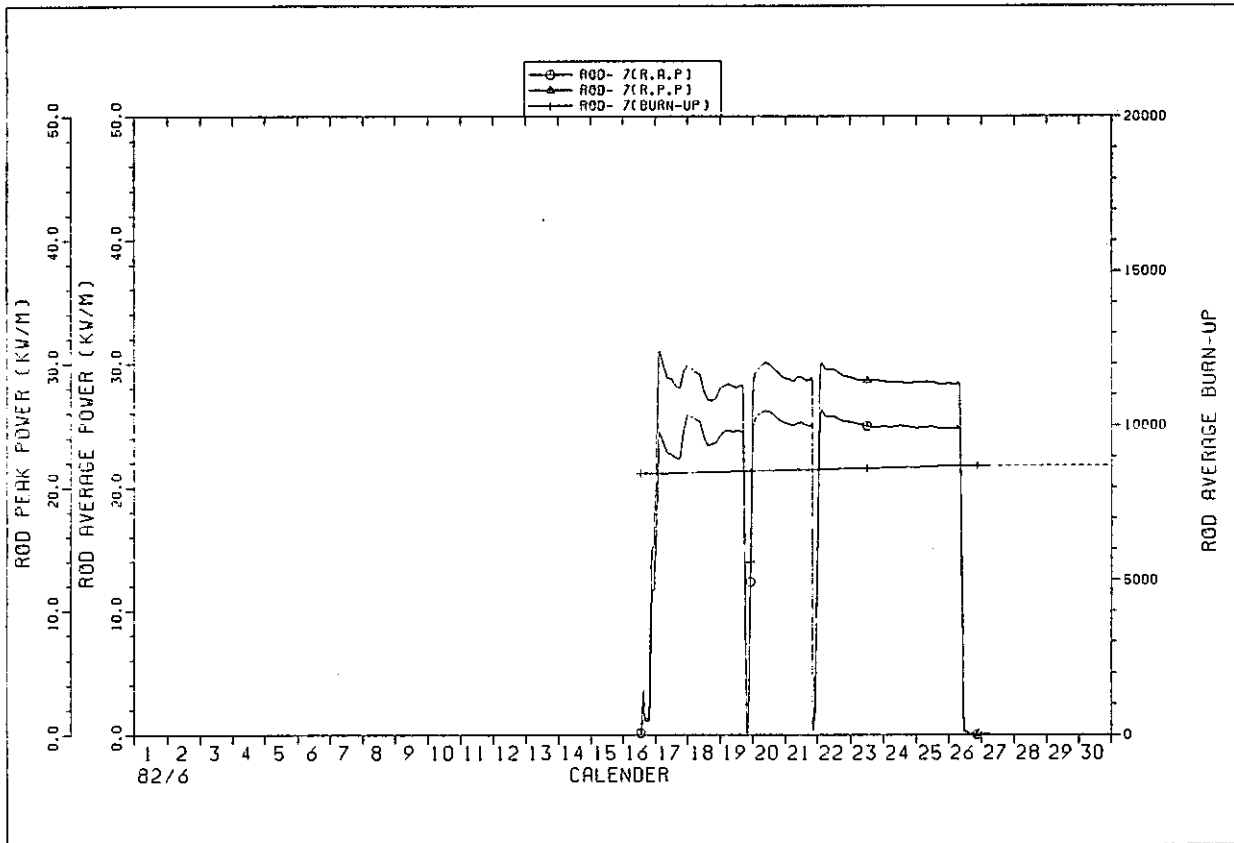

IFA529 ROD POWER HISTORY

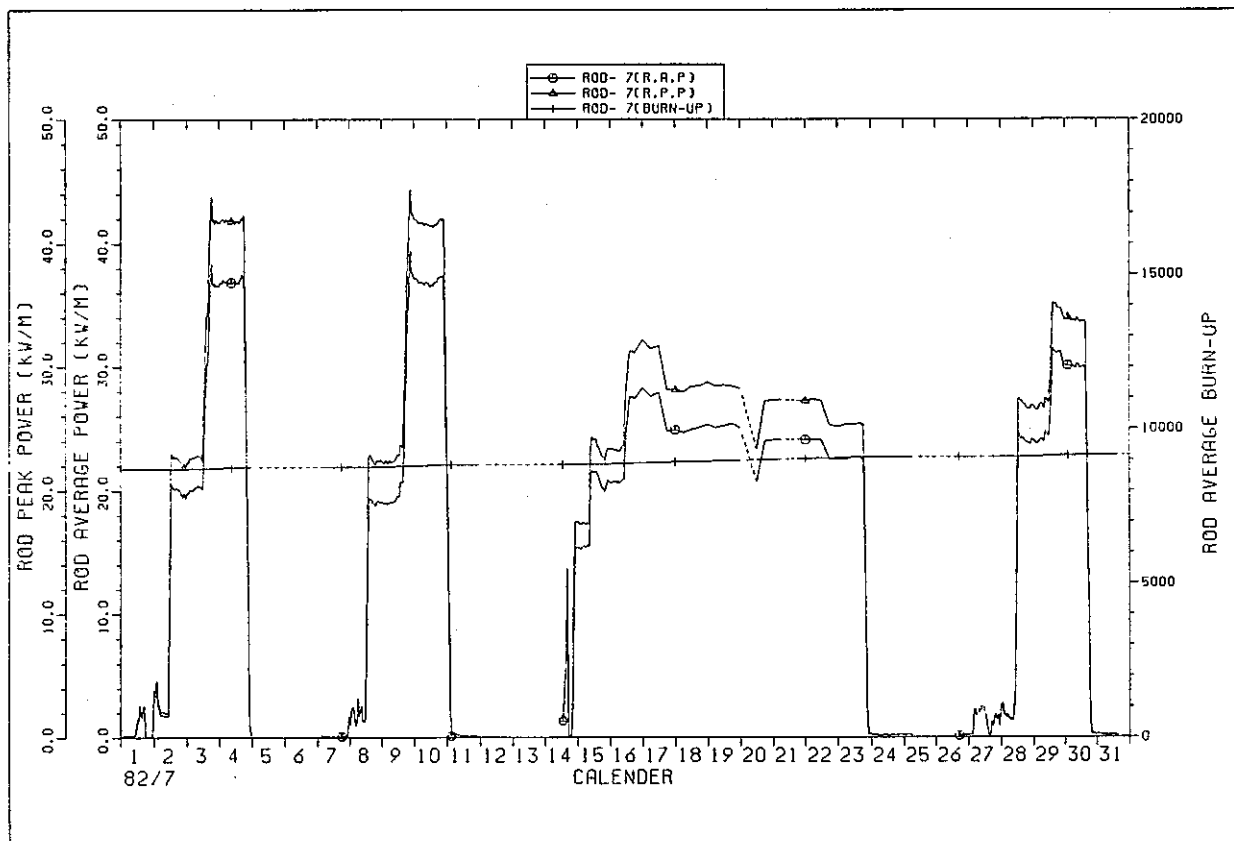

IFA529 ROD POWER HISTORY

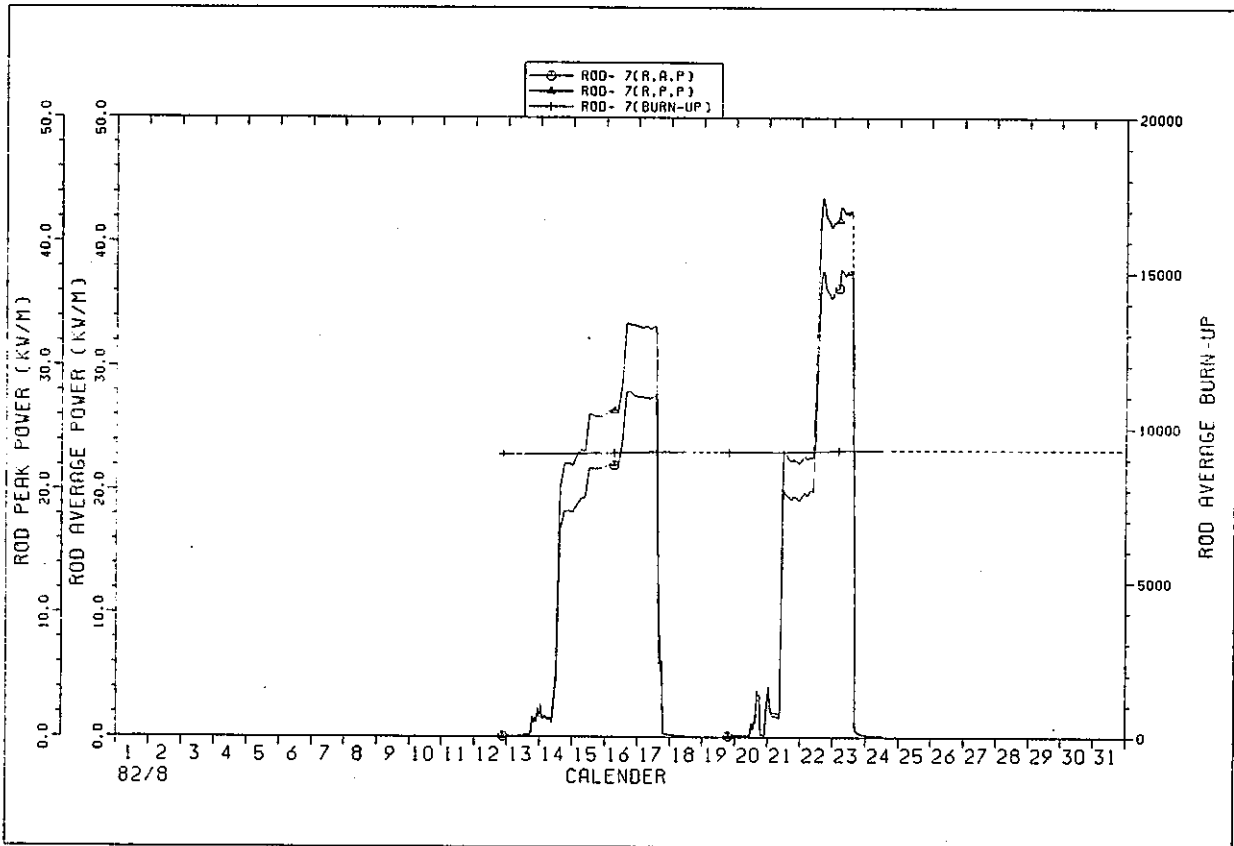

IFA529 ROD POWER HISTORY

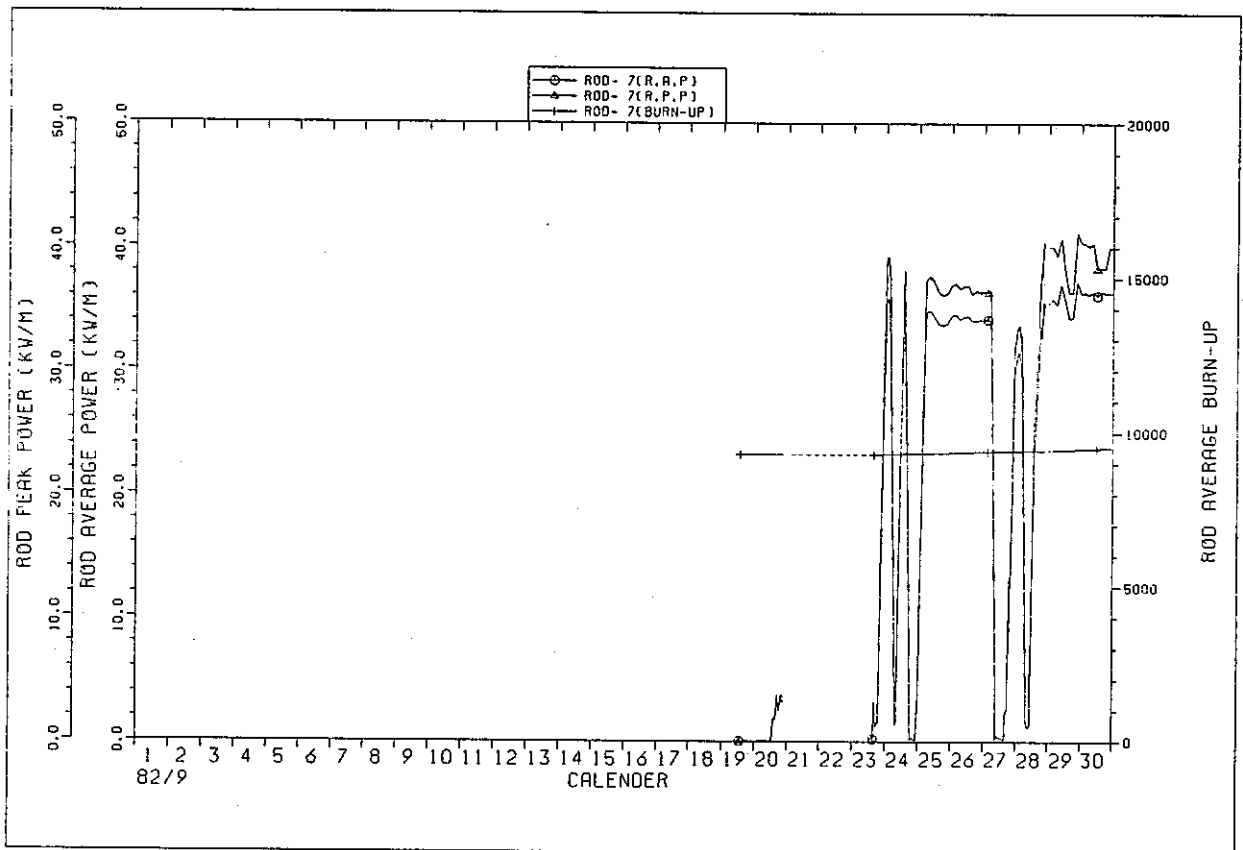

IFA529 ROD POWER HISTORY

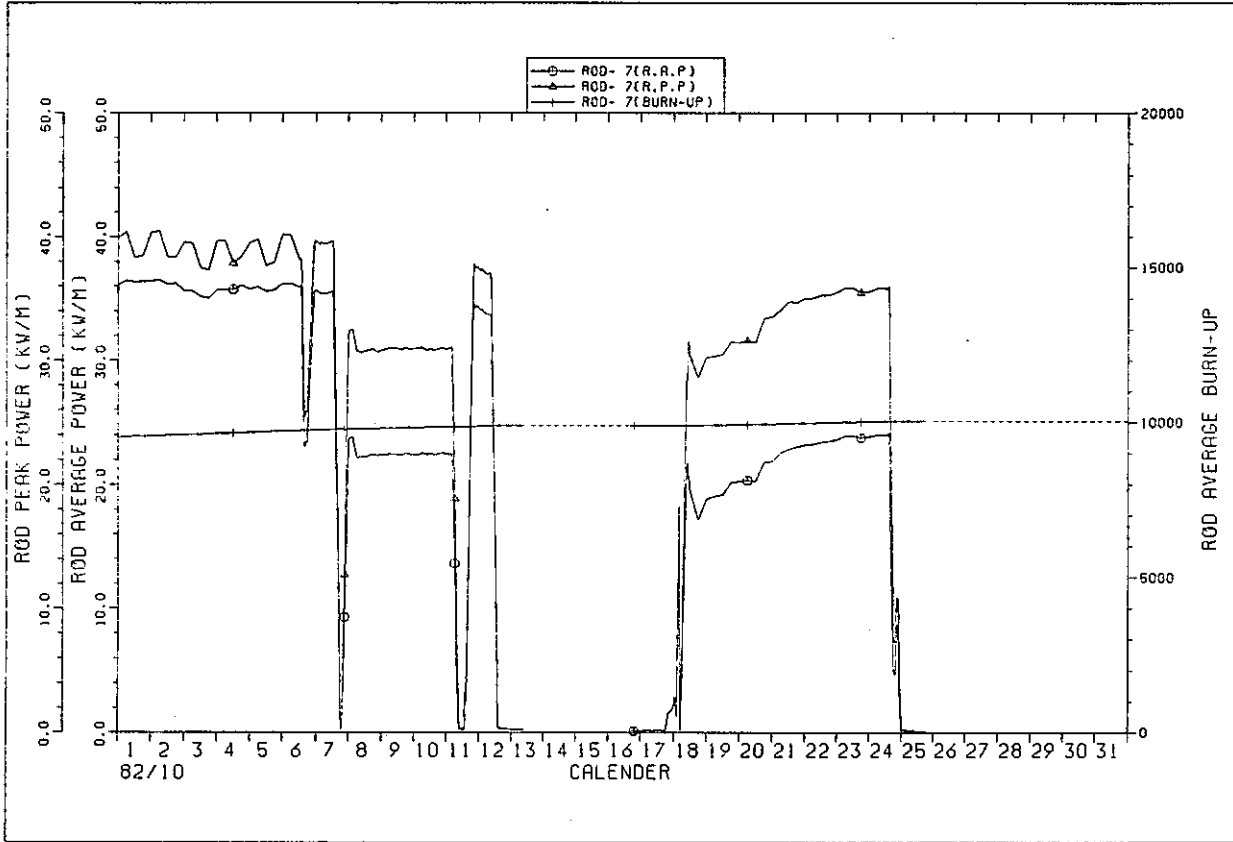

IFA529 ROD POWER HISTORY

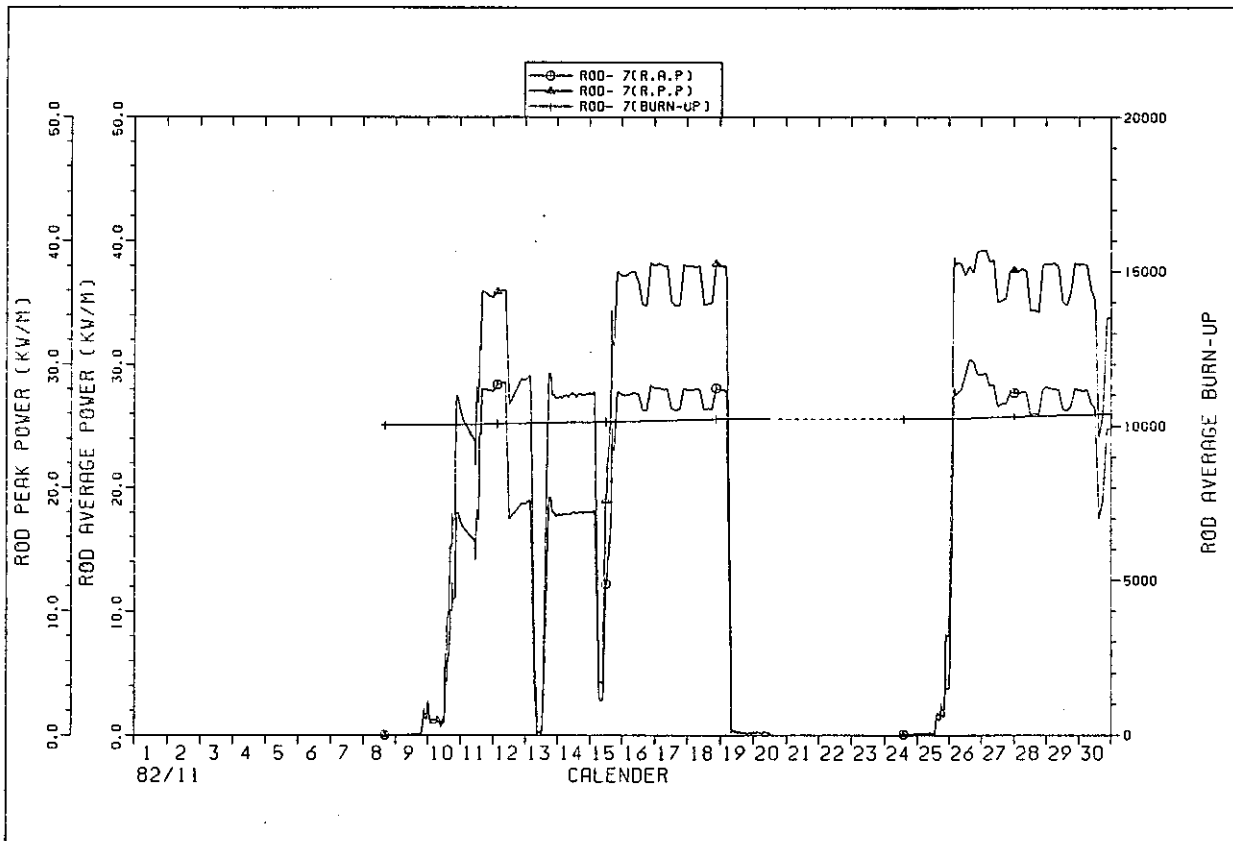

IFA529 ROD POWER HISTORY

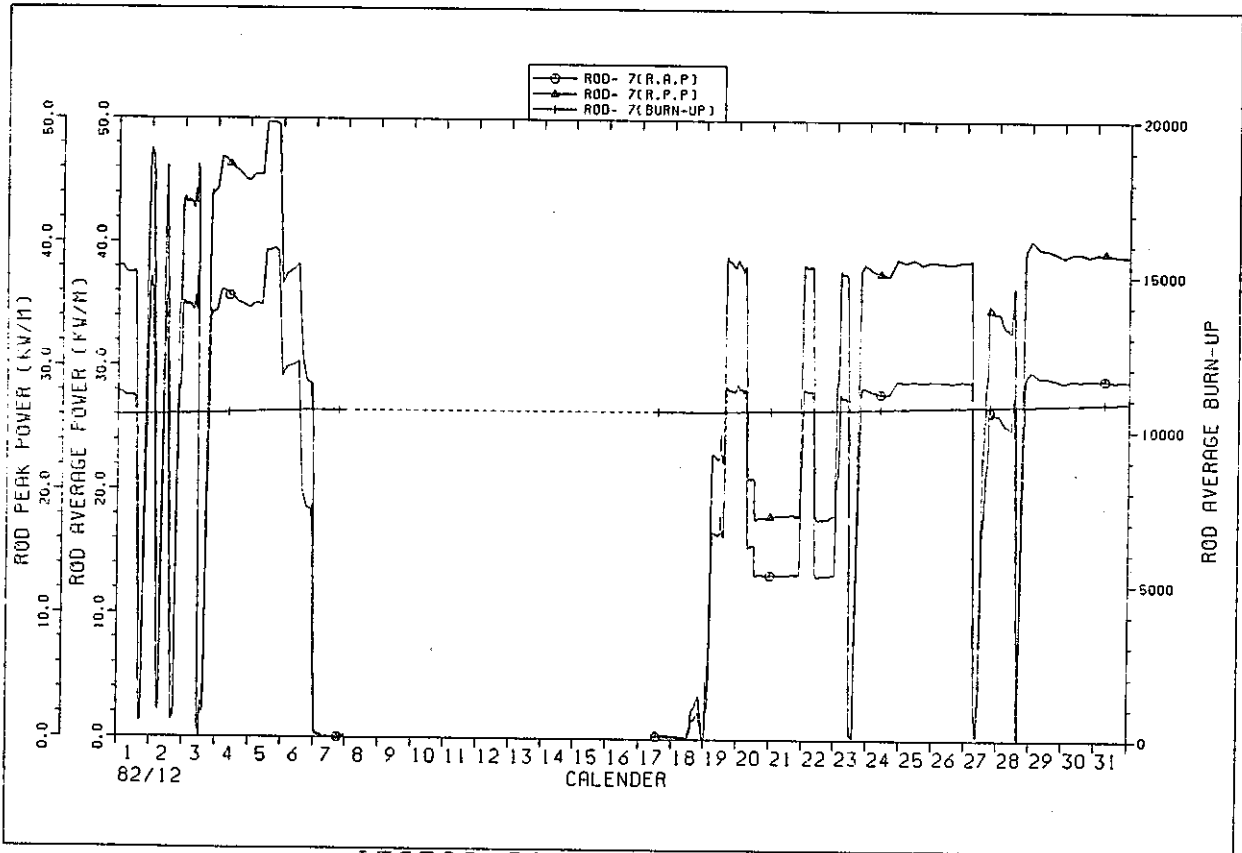

IFA529 ROD POWER HISTORY

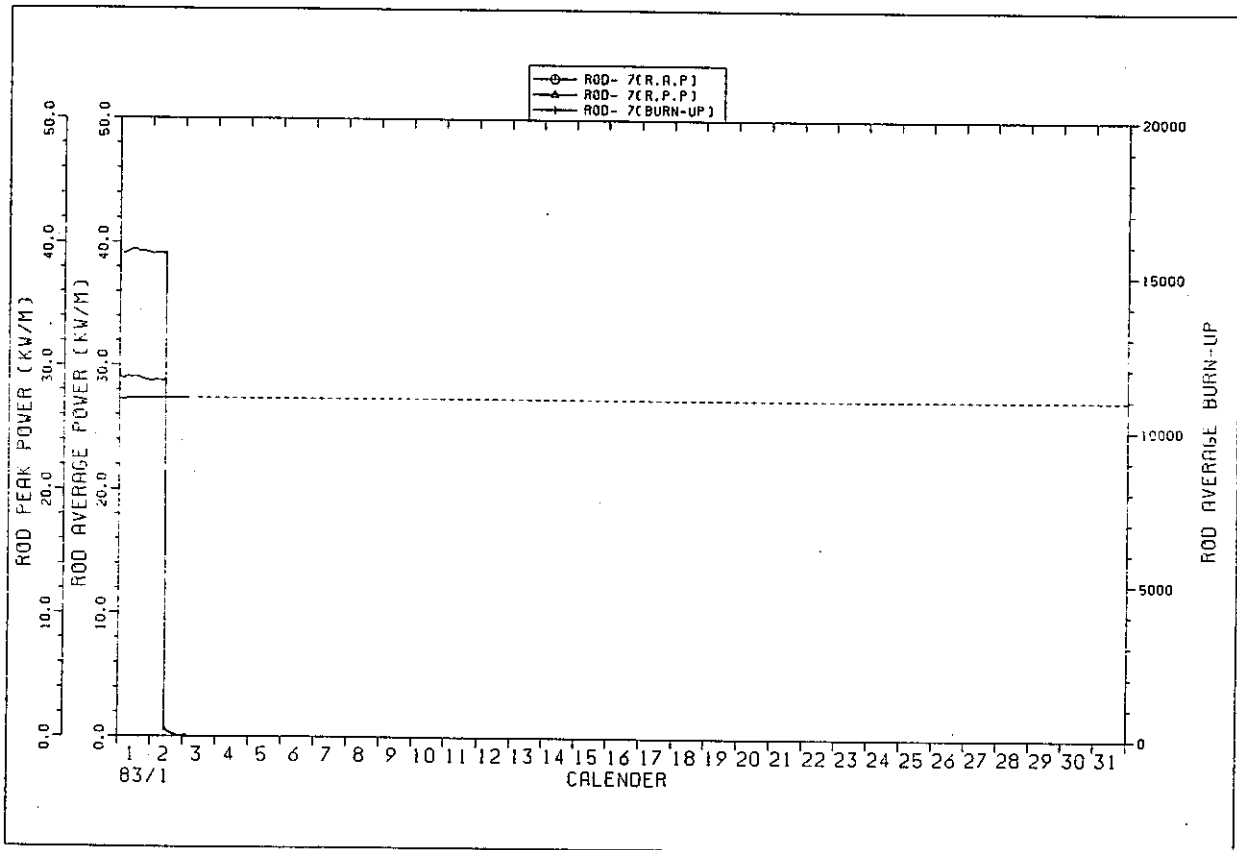

IFA529 ROD POWER HISTORY

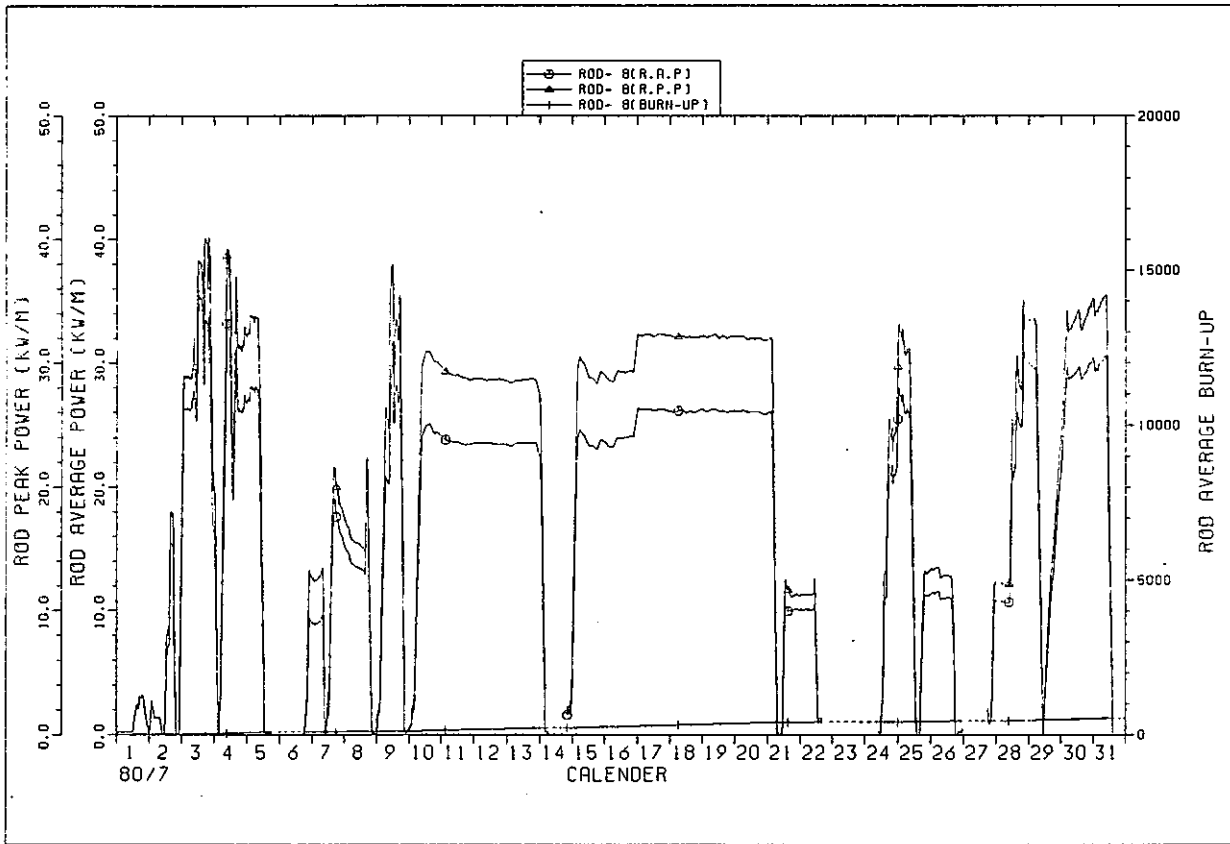

IFA529 ROD POWER HISTORY

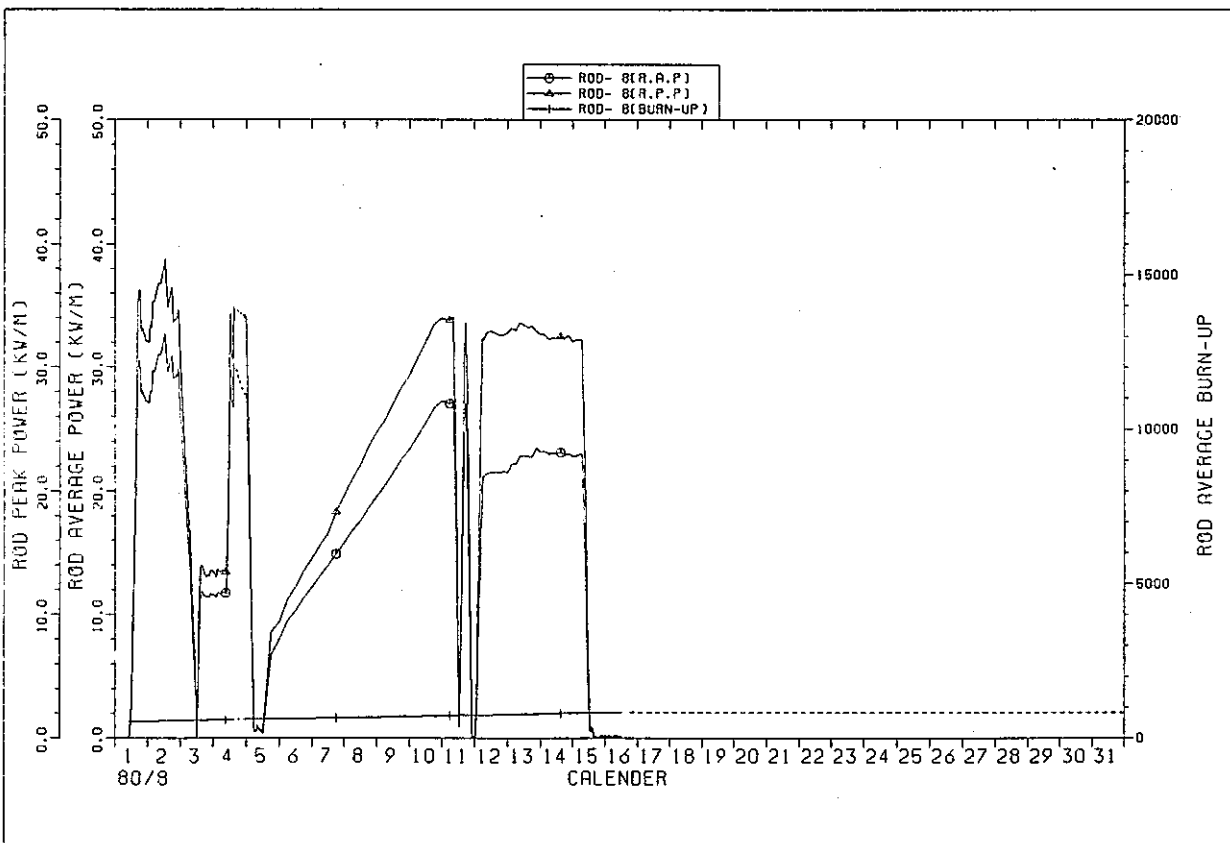

IFA529 ROD POWER HISTORY

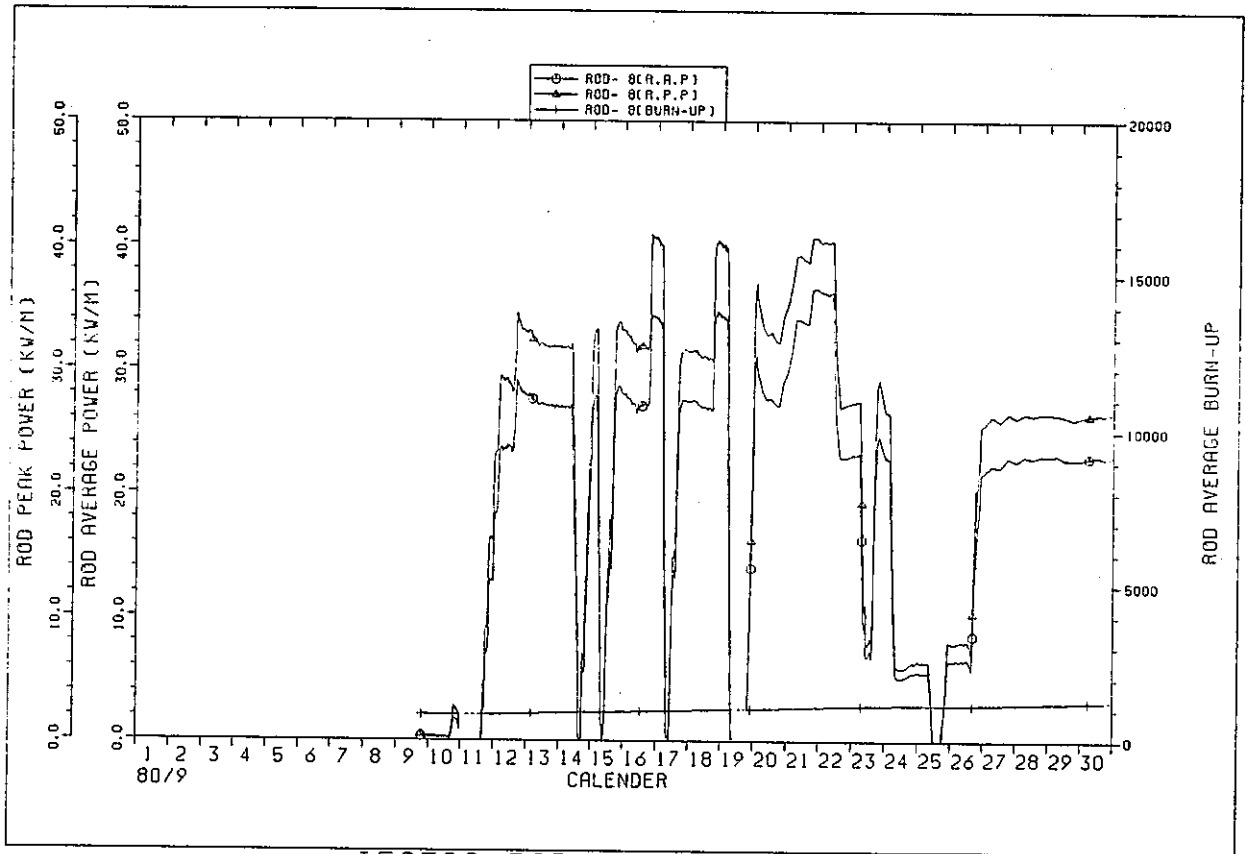

IFA529 ROD POWER HISTORY

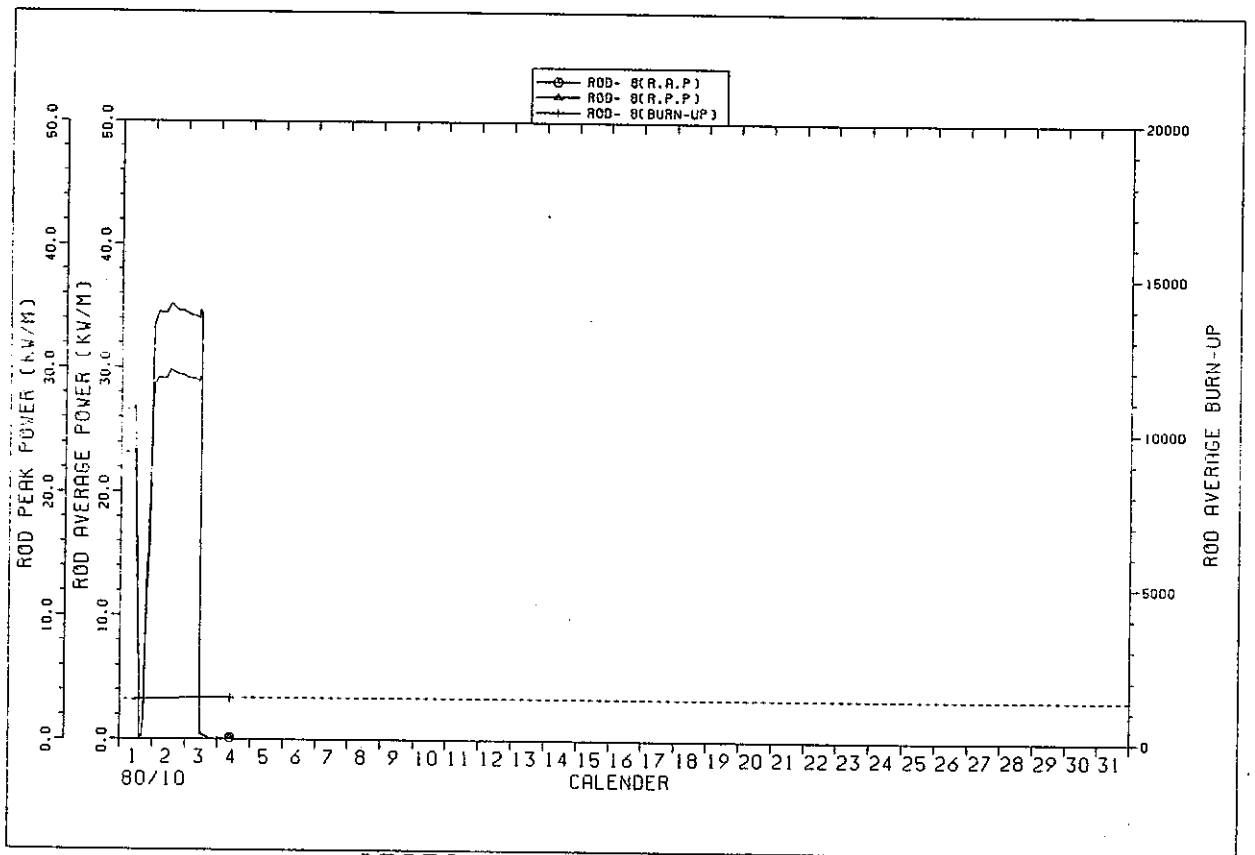

IFA529 ROD POWER HISTORY

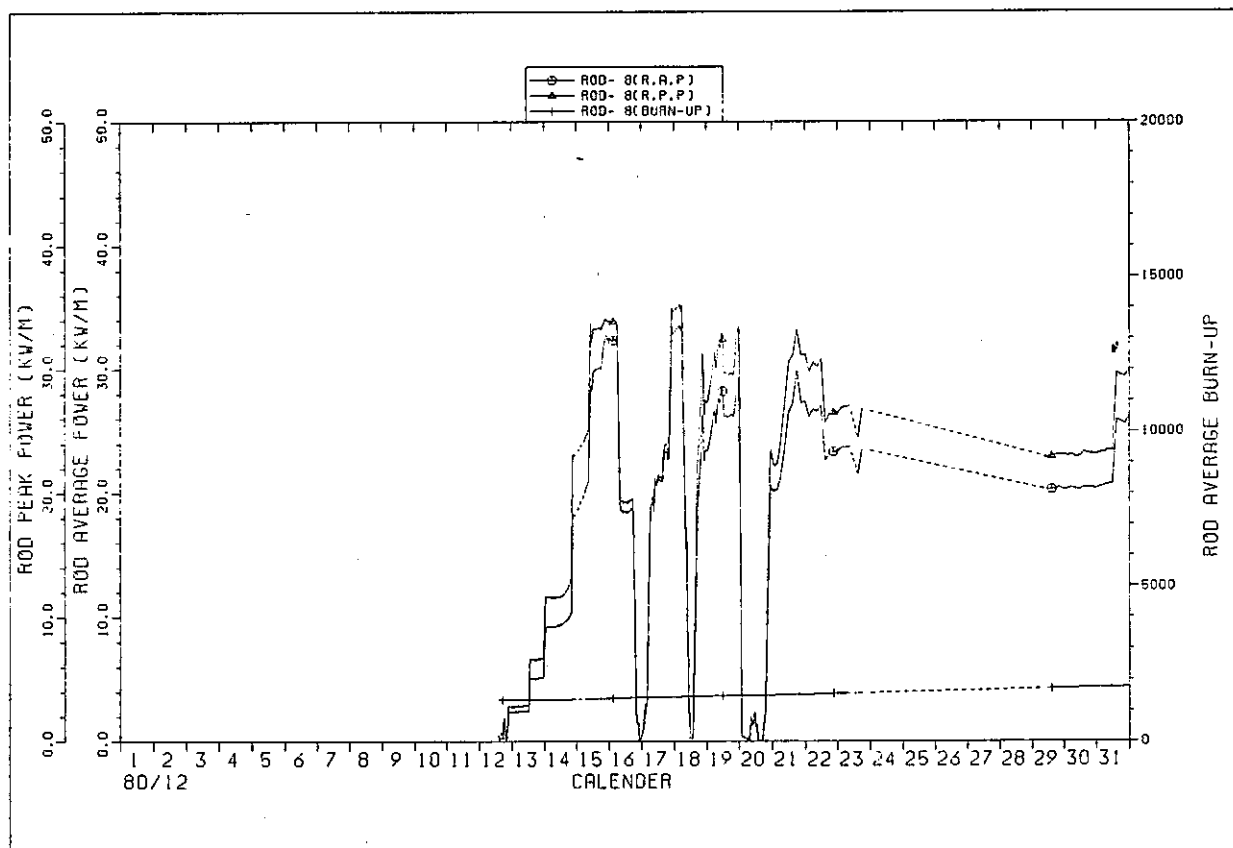

IFA529 ROD POWER HISTORY

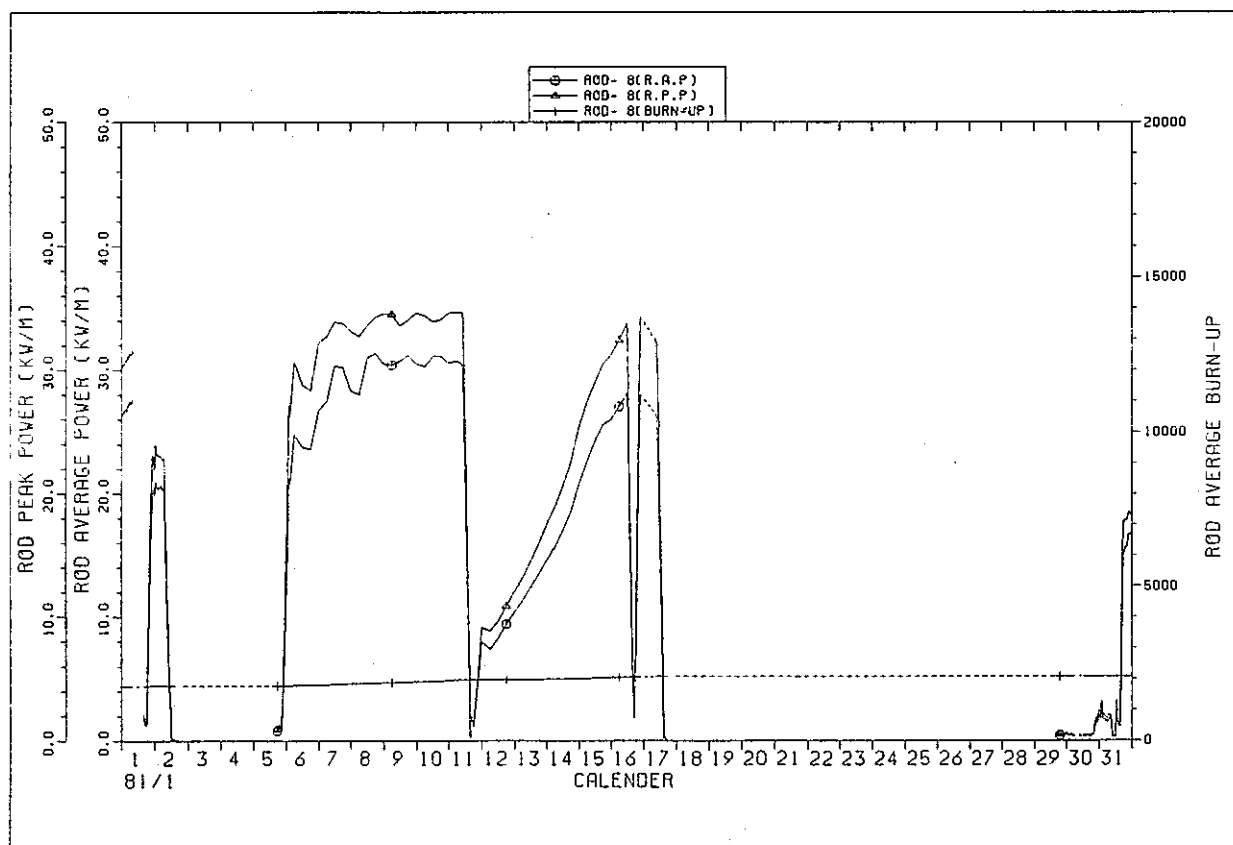

IFA529 ROD POWER HISTORY

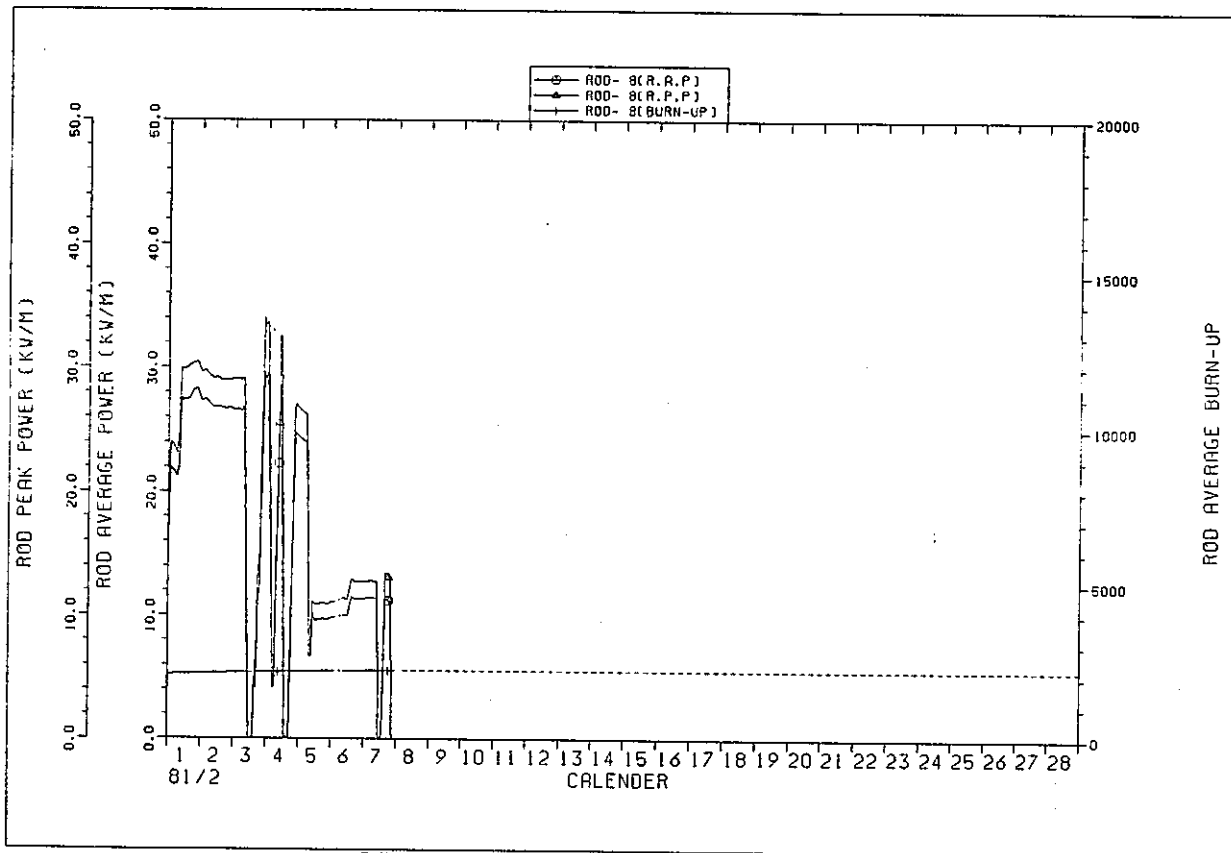

IFA529 ROD POWER HISTORY

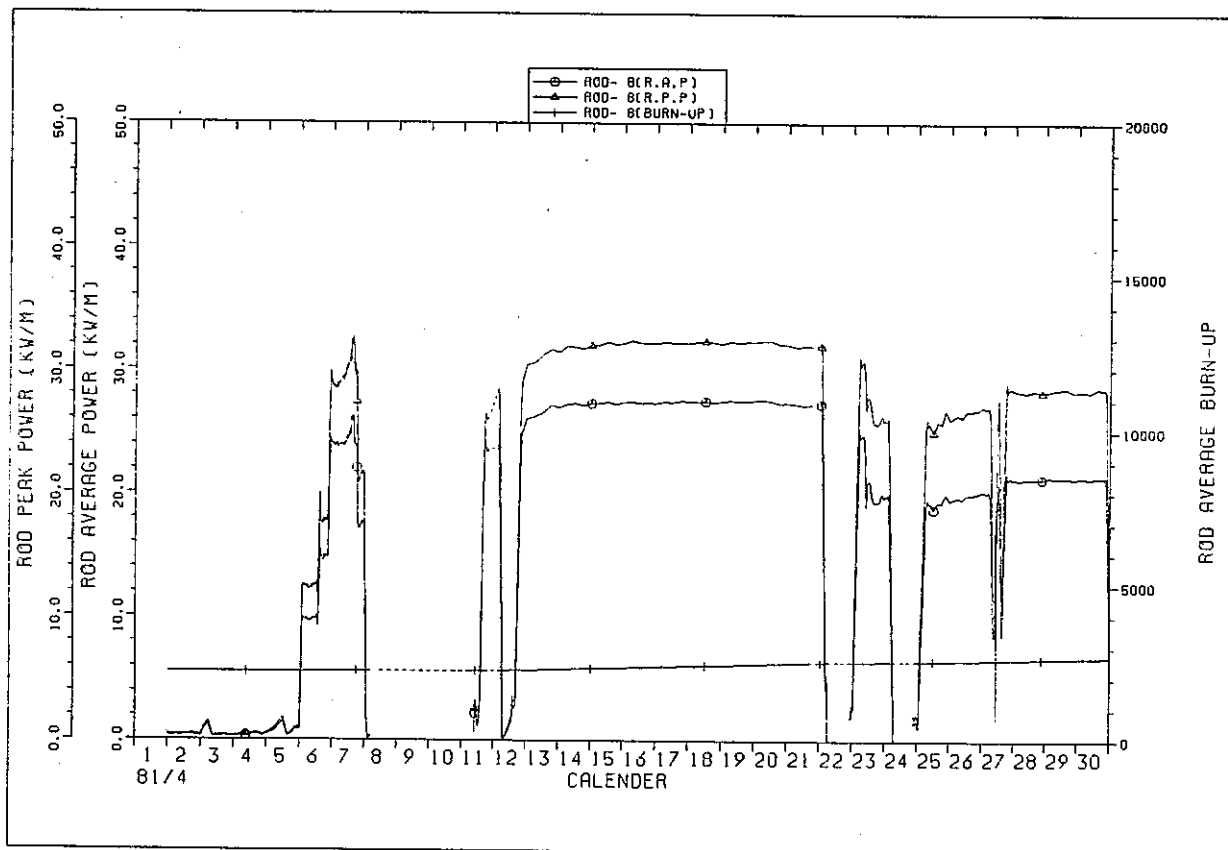

IFA529 ROD POWER HISTORY

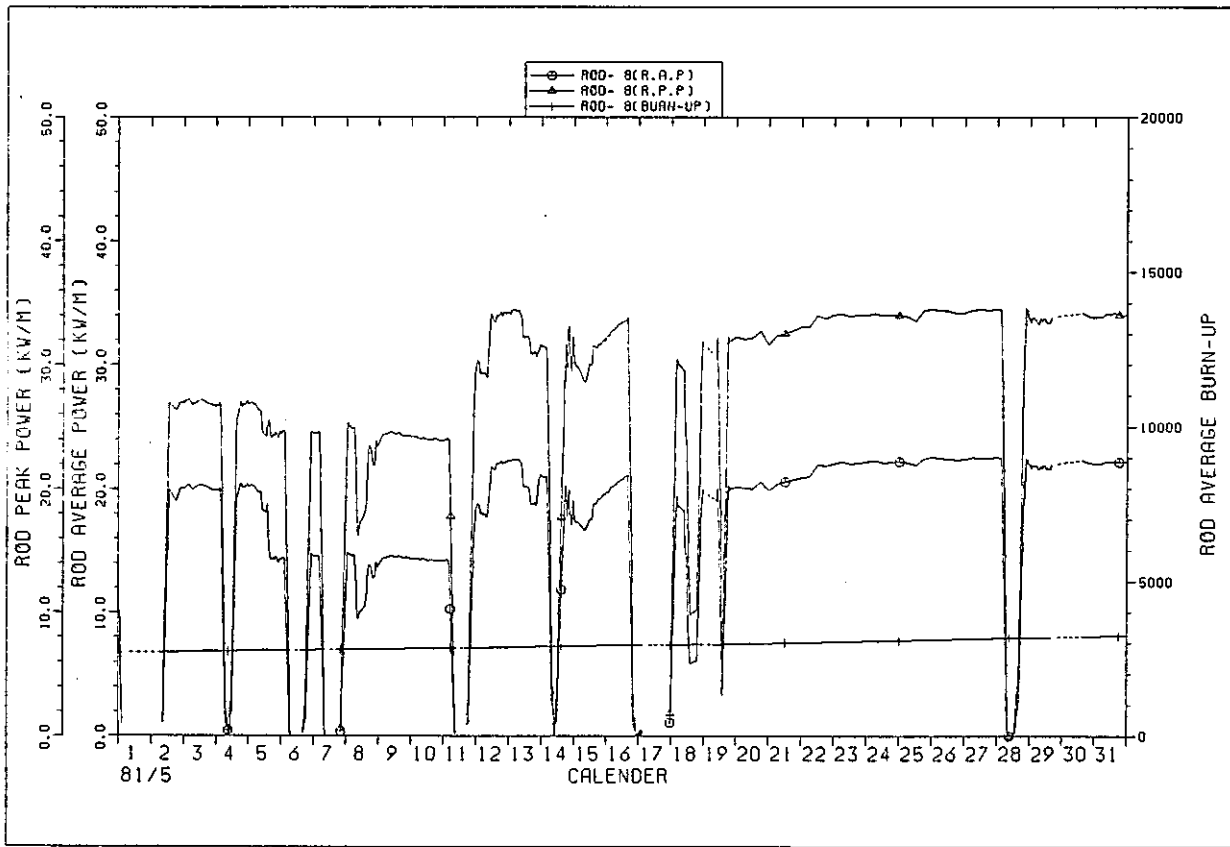

IFA529 ROD POWER HISTORY

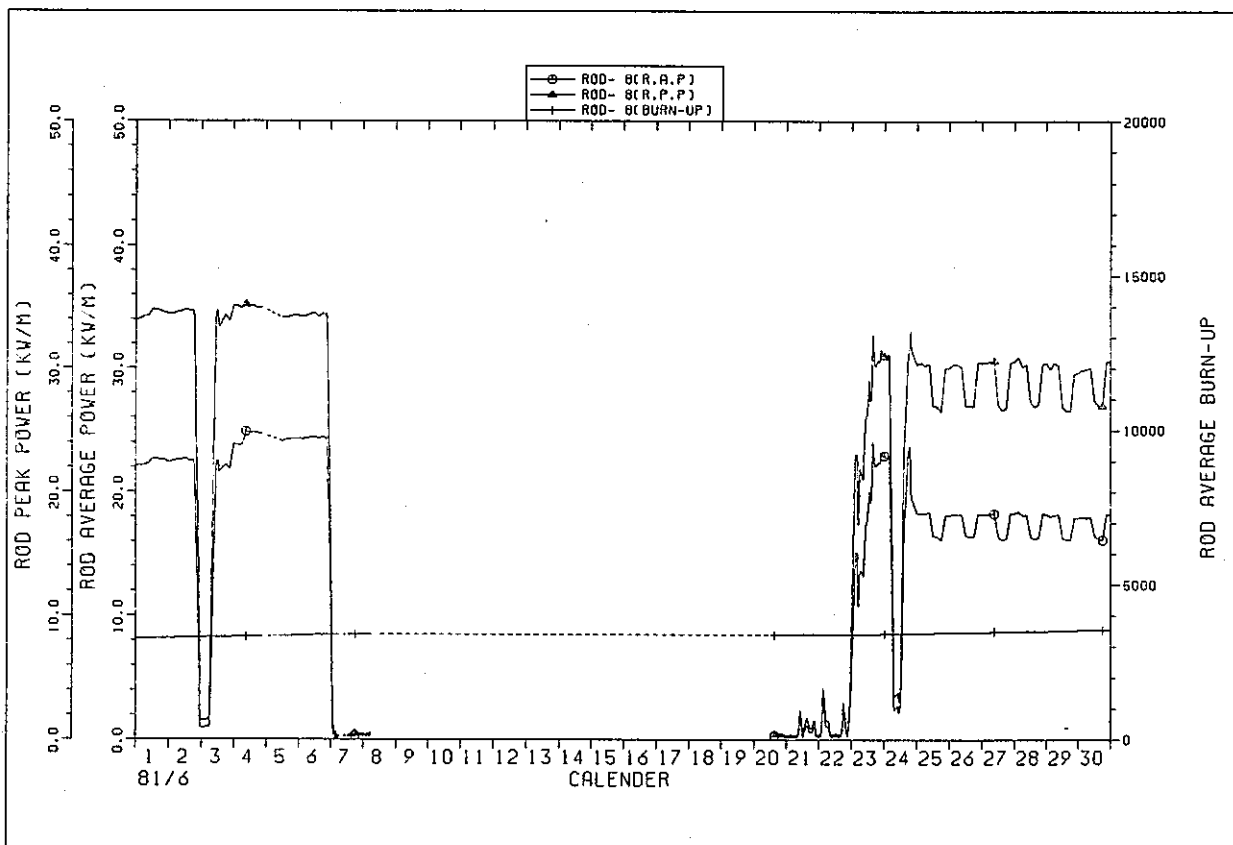

IFA529 ROD POWER HISTORY

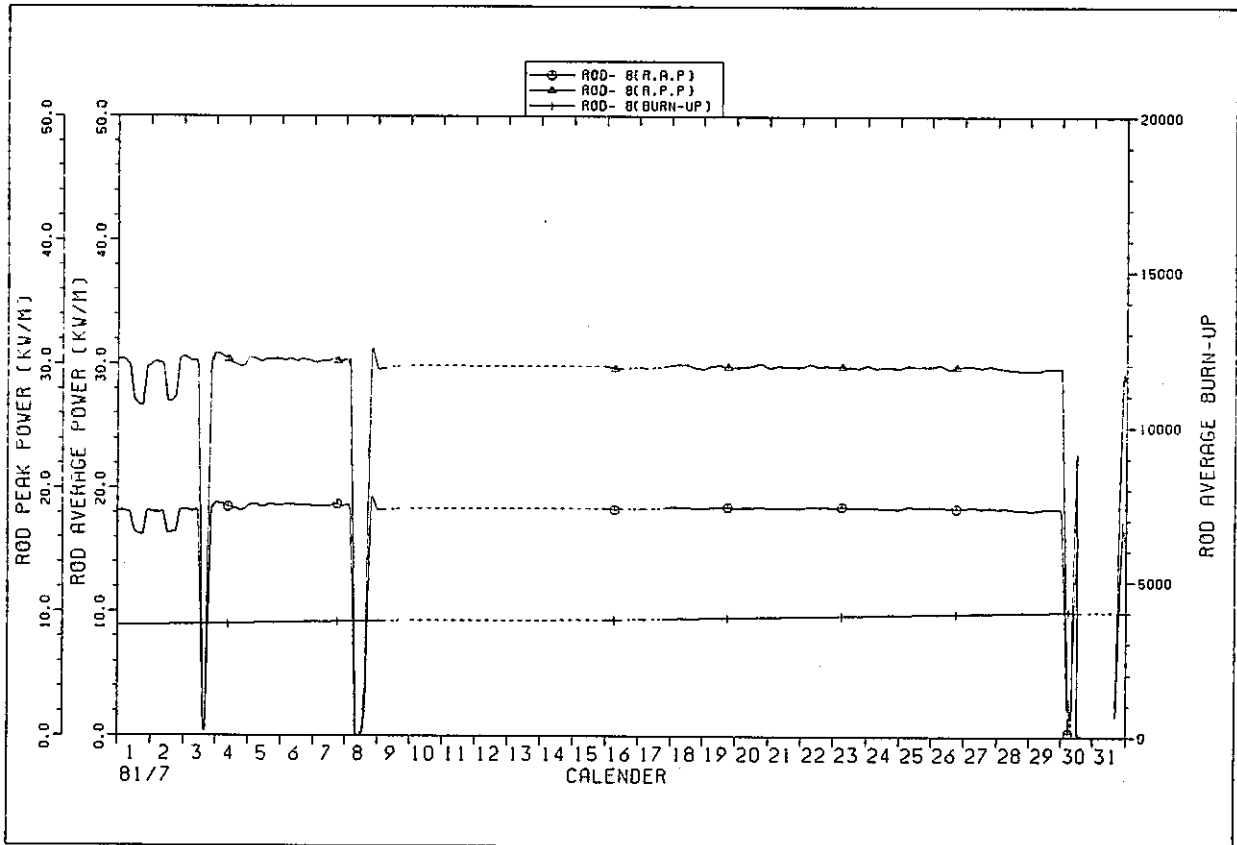

IFA529 ROD POWER HISTORY

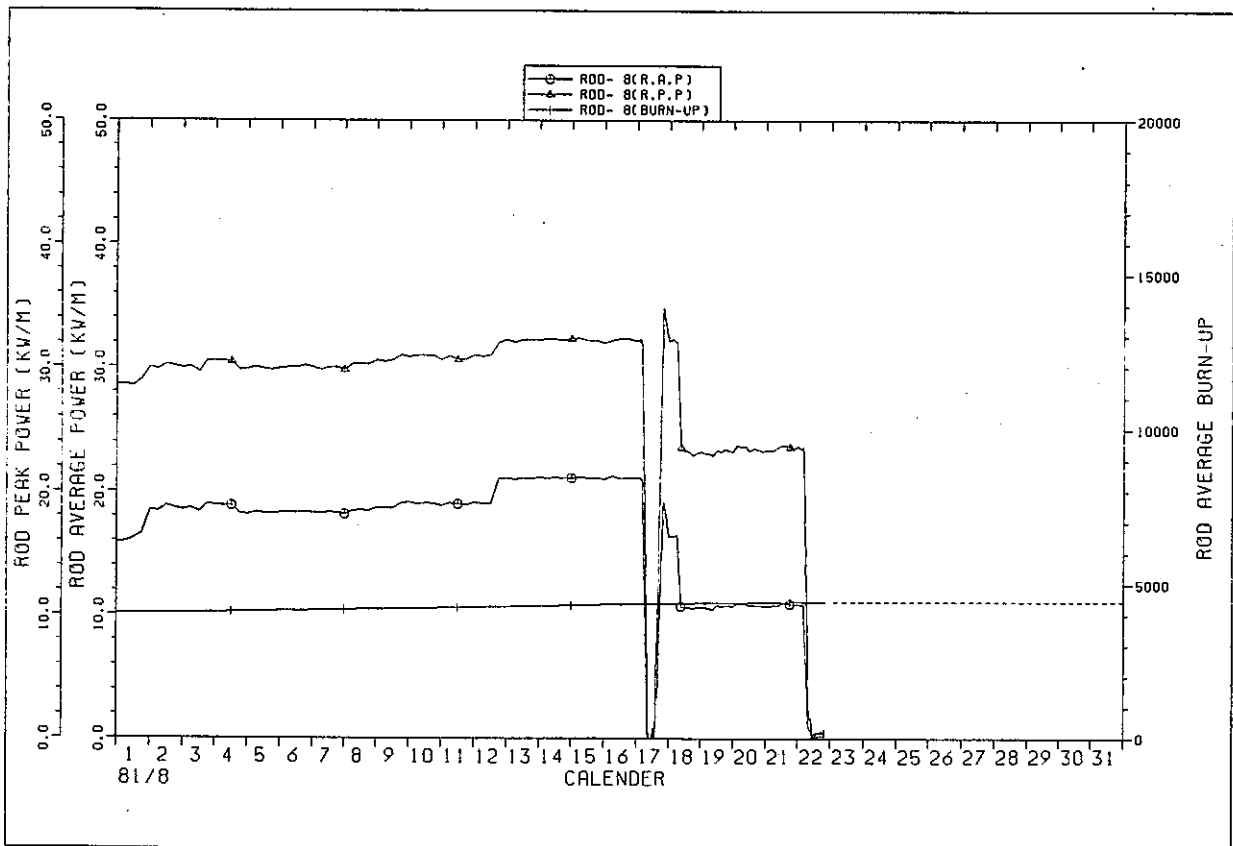

IFA529 ROD POWER HISTORY

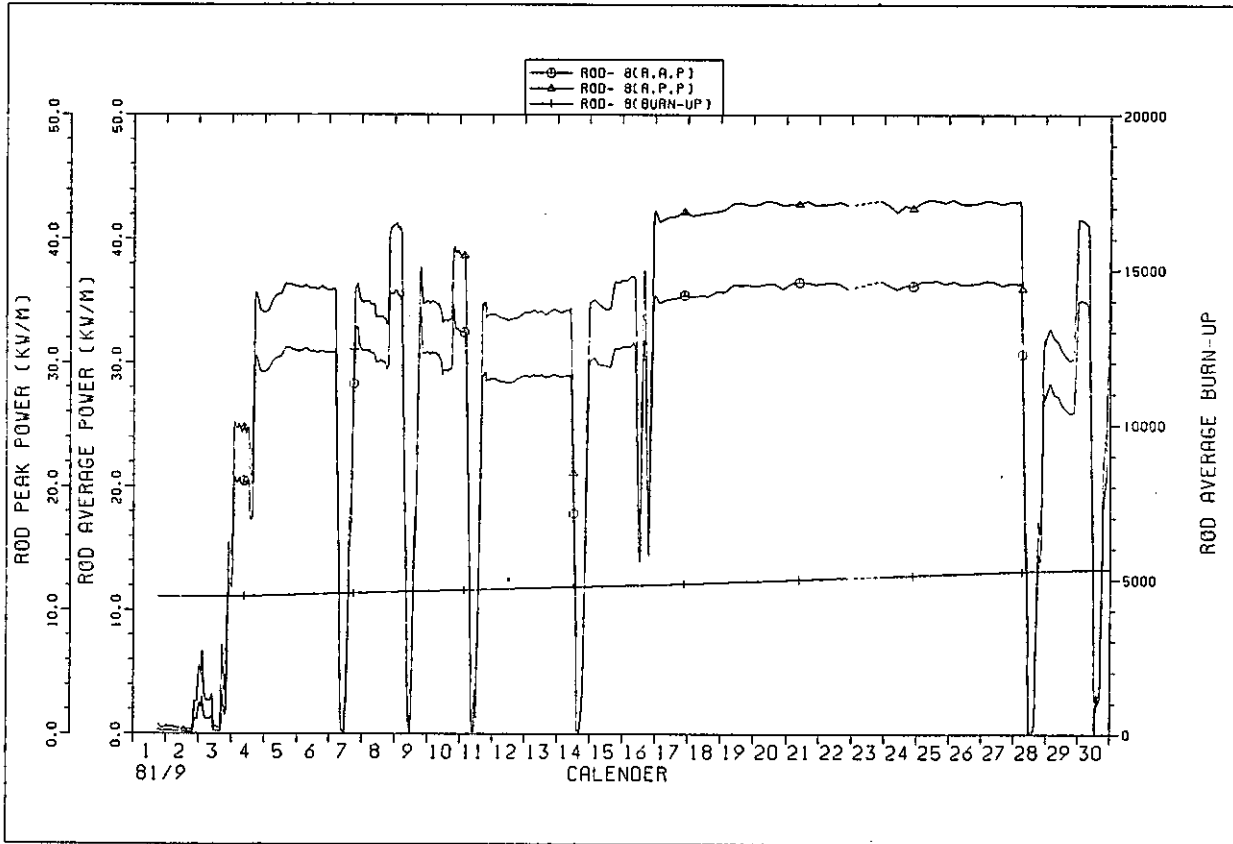

IFA529 ROD POWER HISTORY

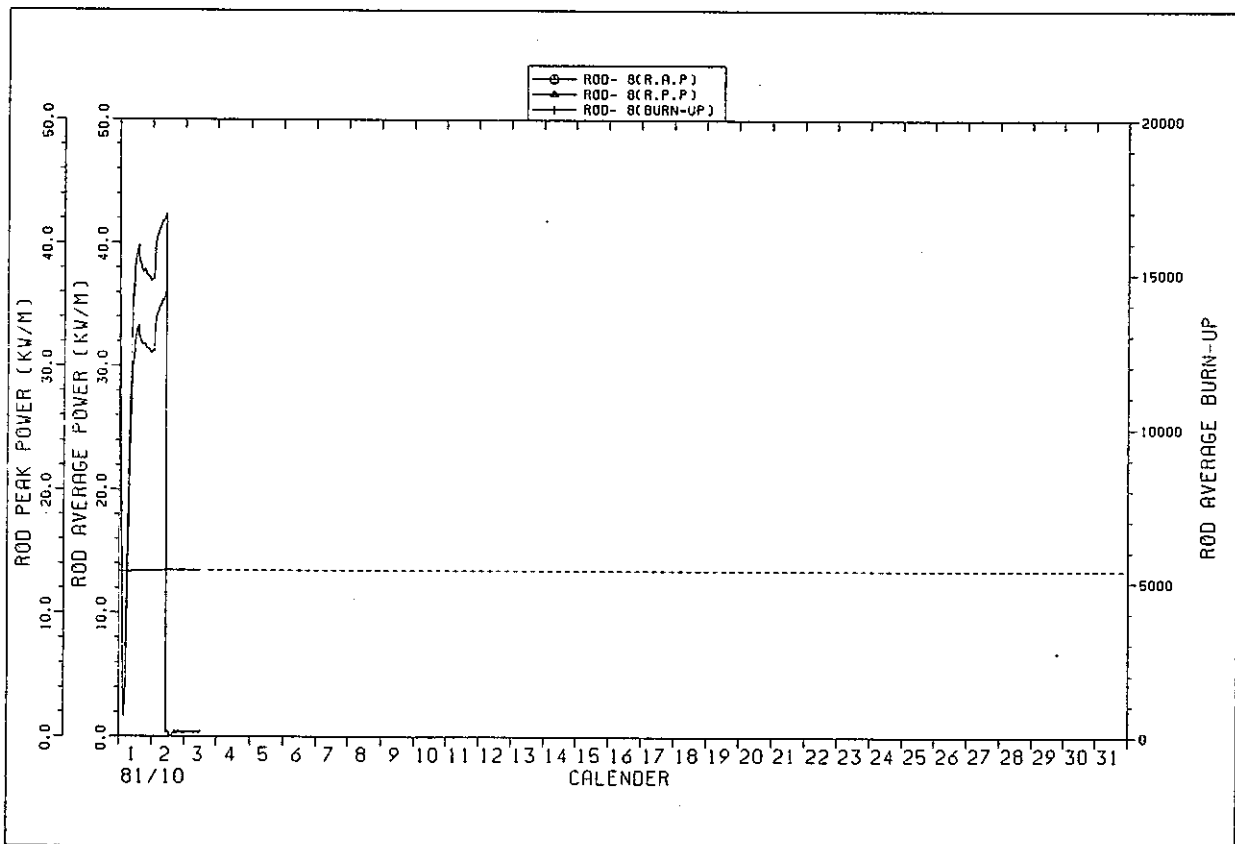

IFA529 ROD POWER HISTORY

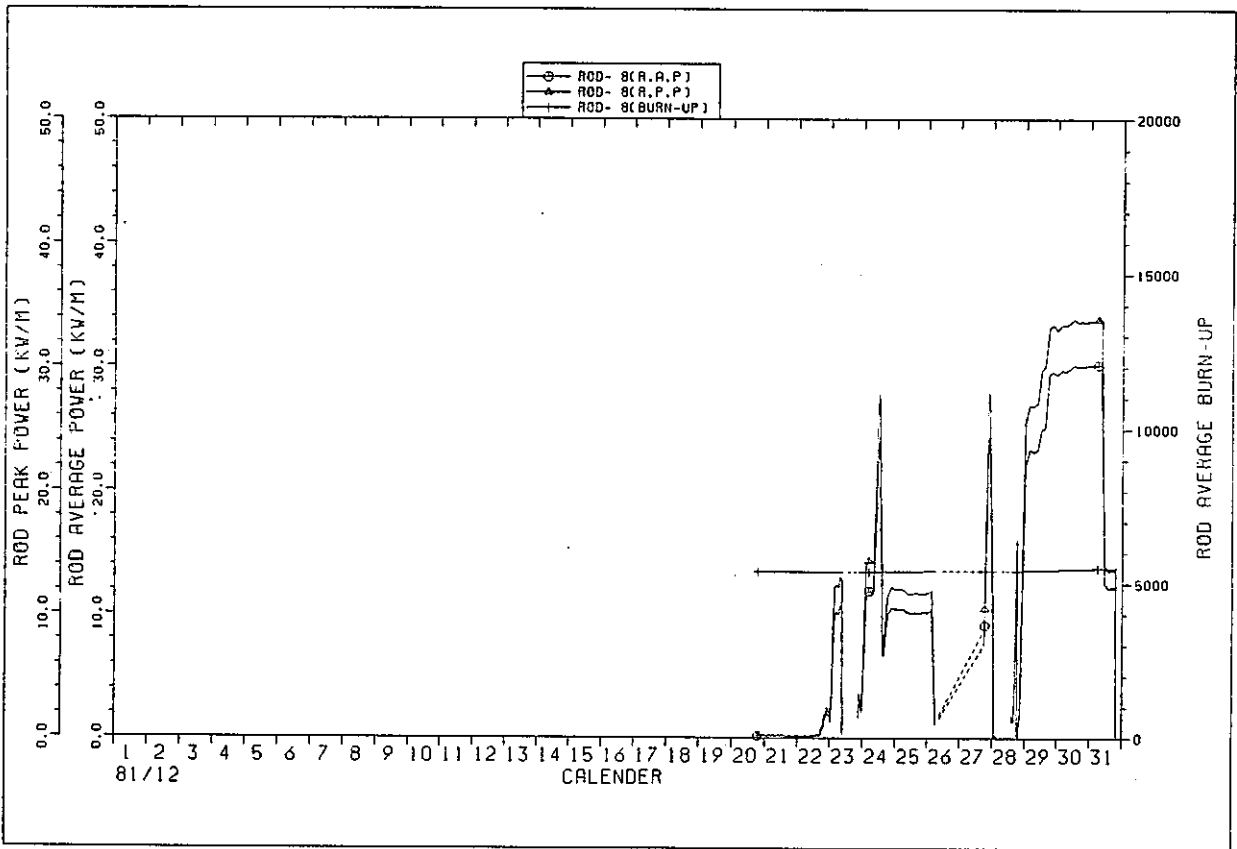

IFA529 ROD POWER HISTORY

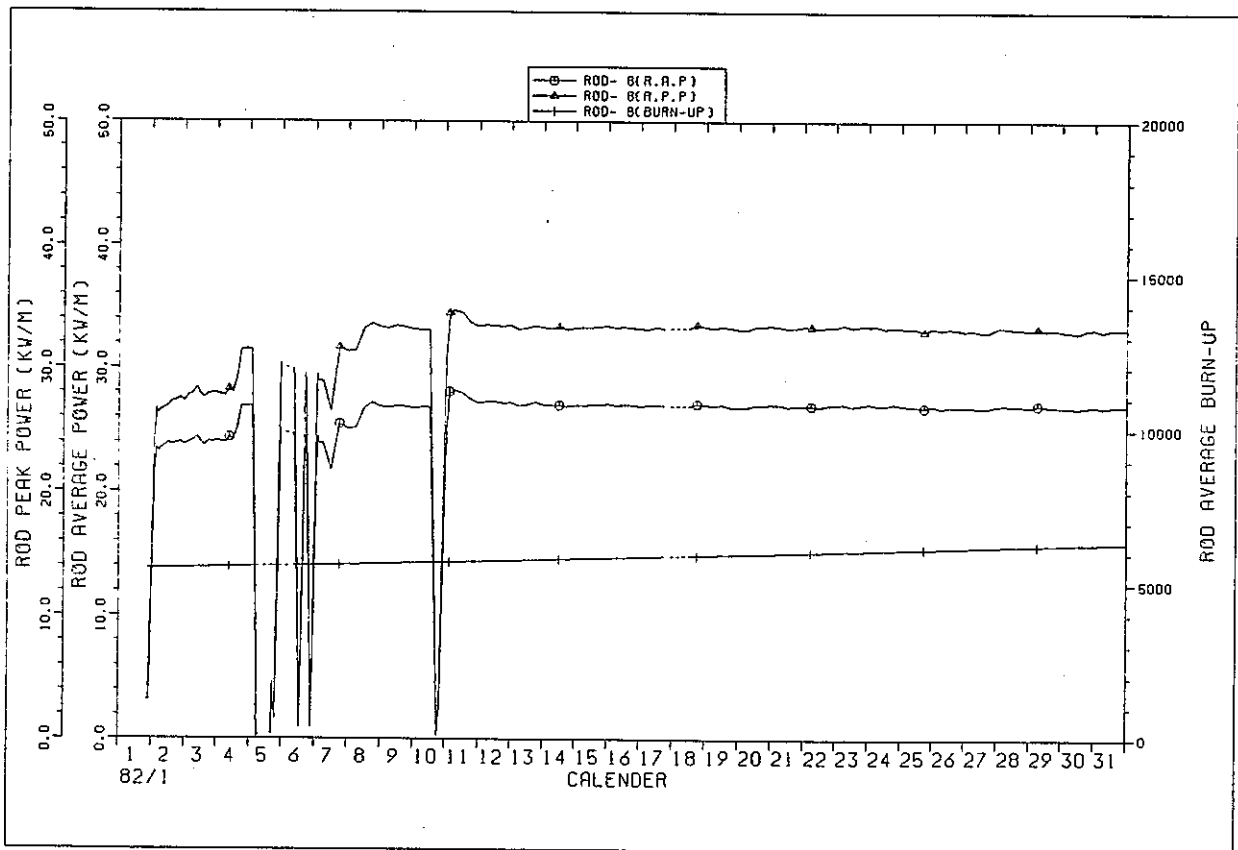

IFA529 ROD POWER HISTORY

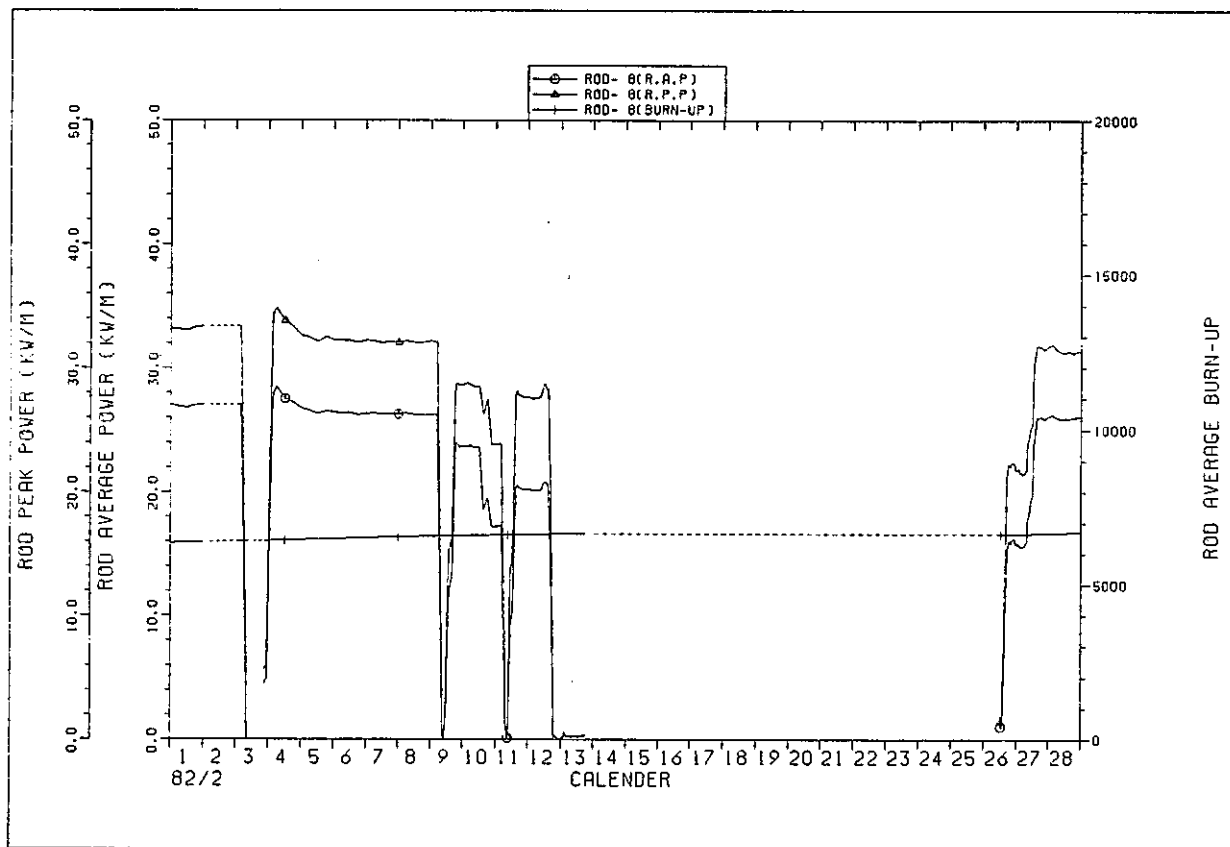

IFA529 ROD POWER HISTORY

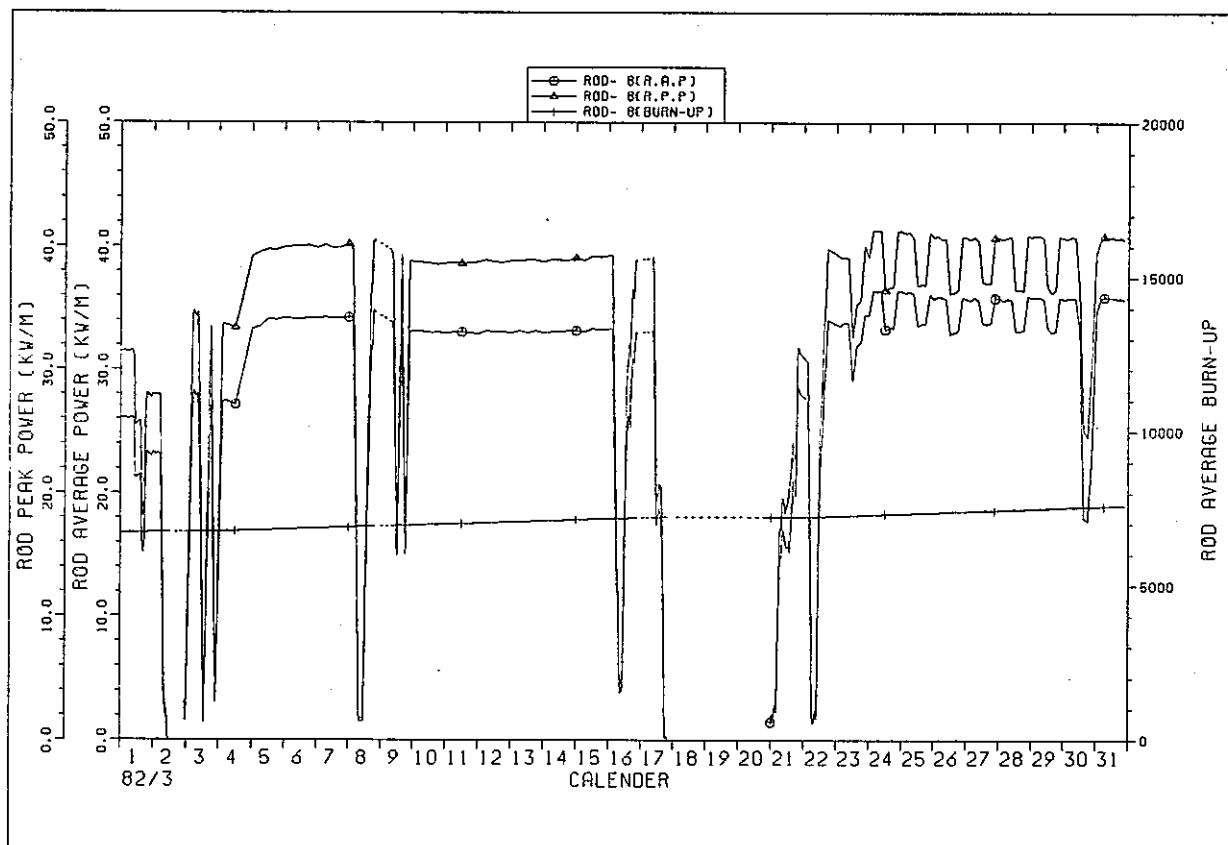

IFA529 ROD POWER HISTORY

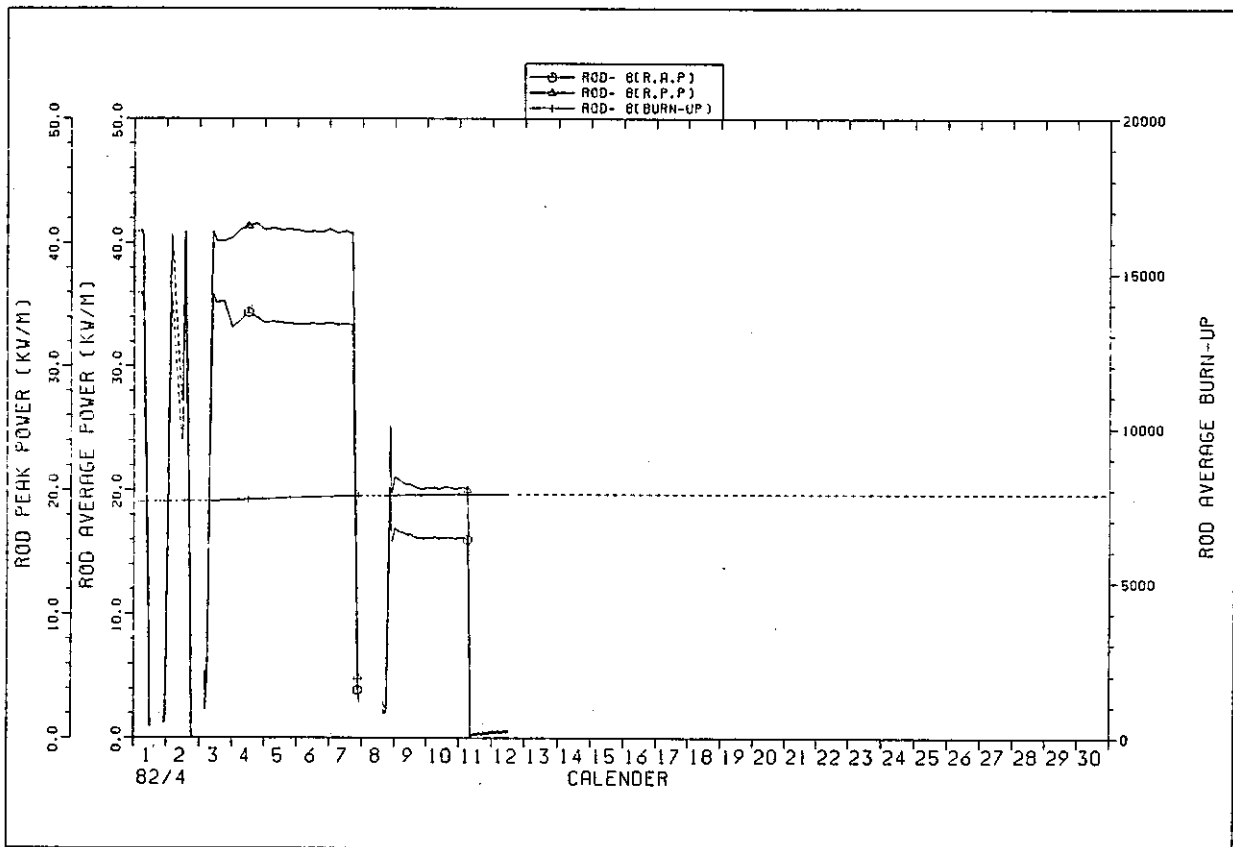

IFA529 ROD POWER HISTORY

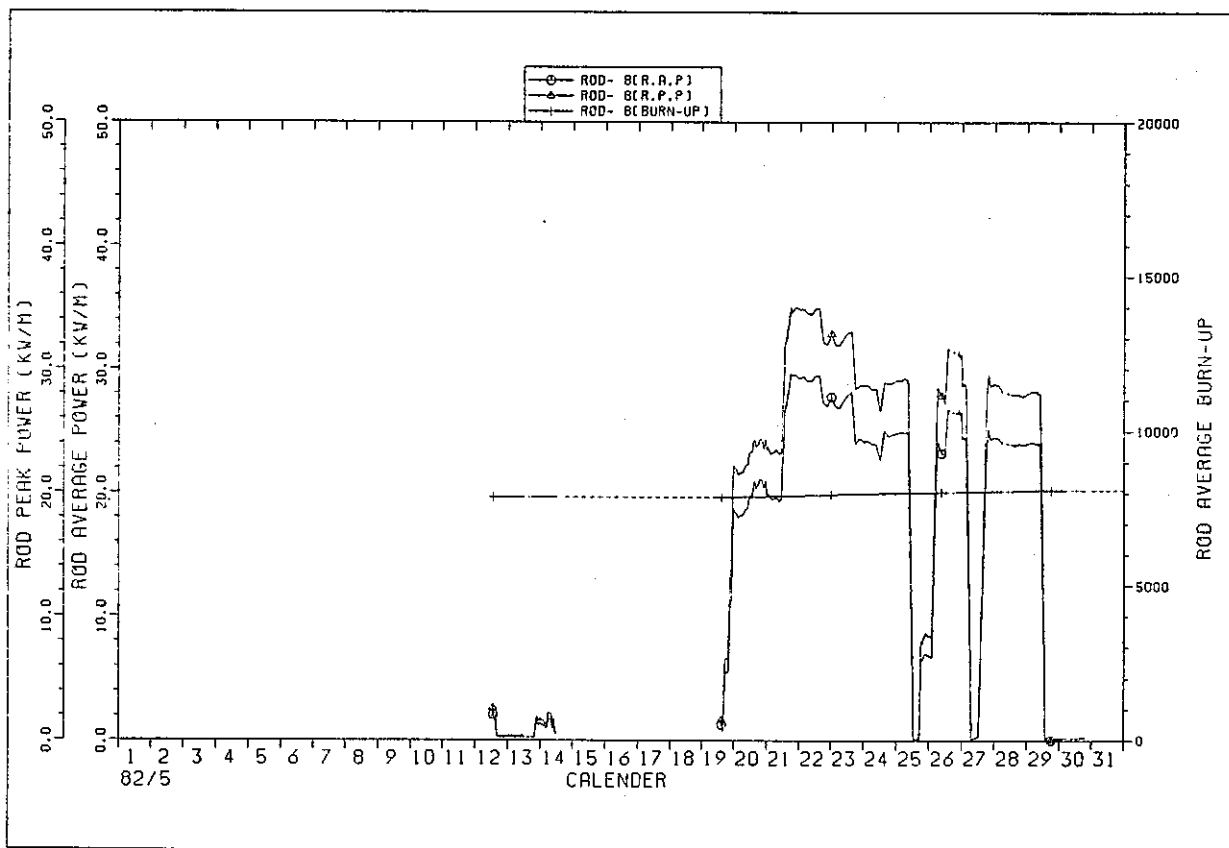

IFA529 ROD POWER HISTORY

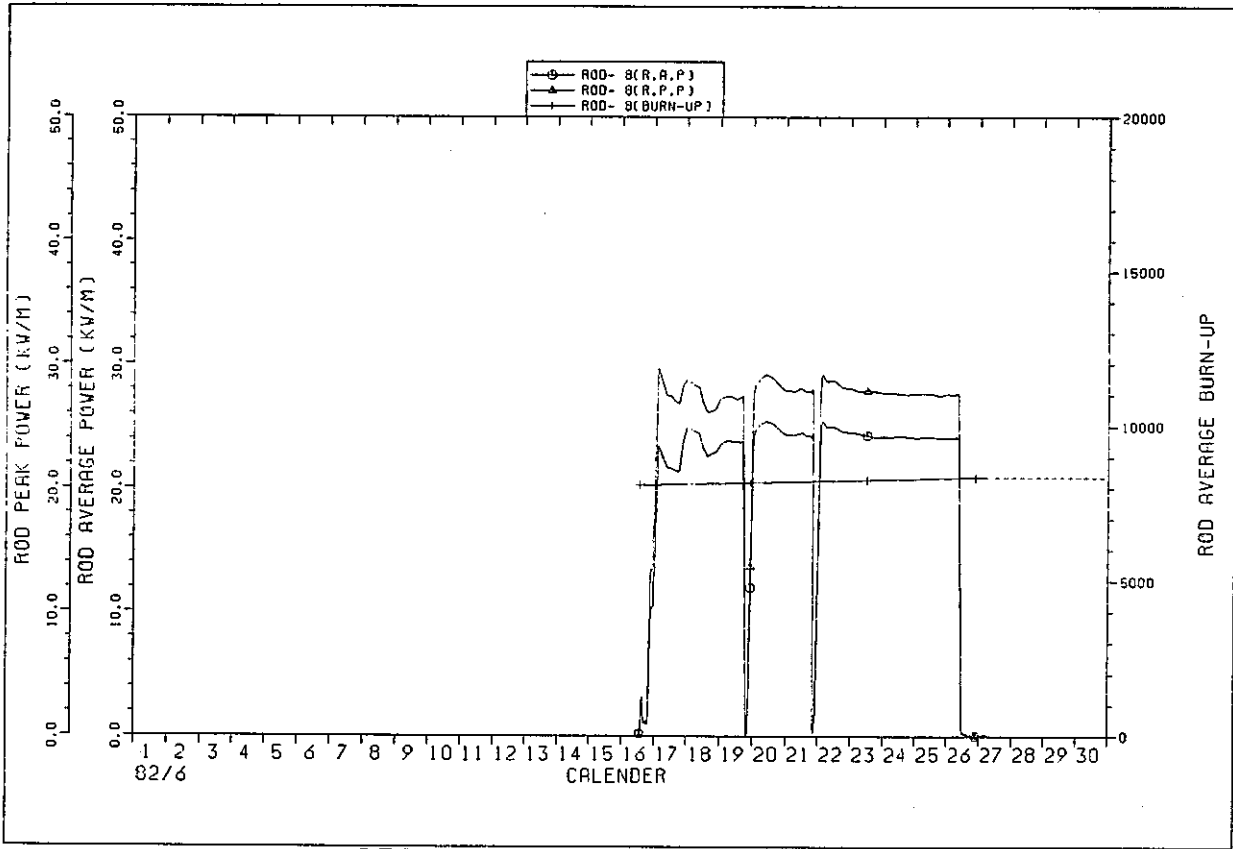

IFA529 ROD POWER HISTORY

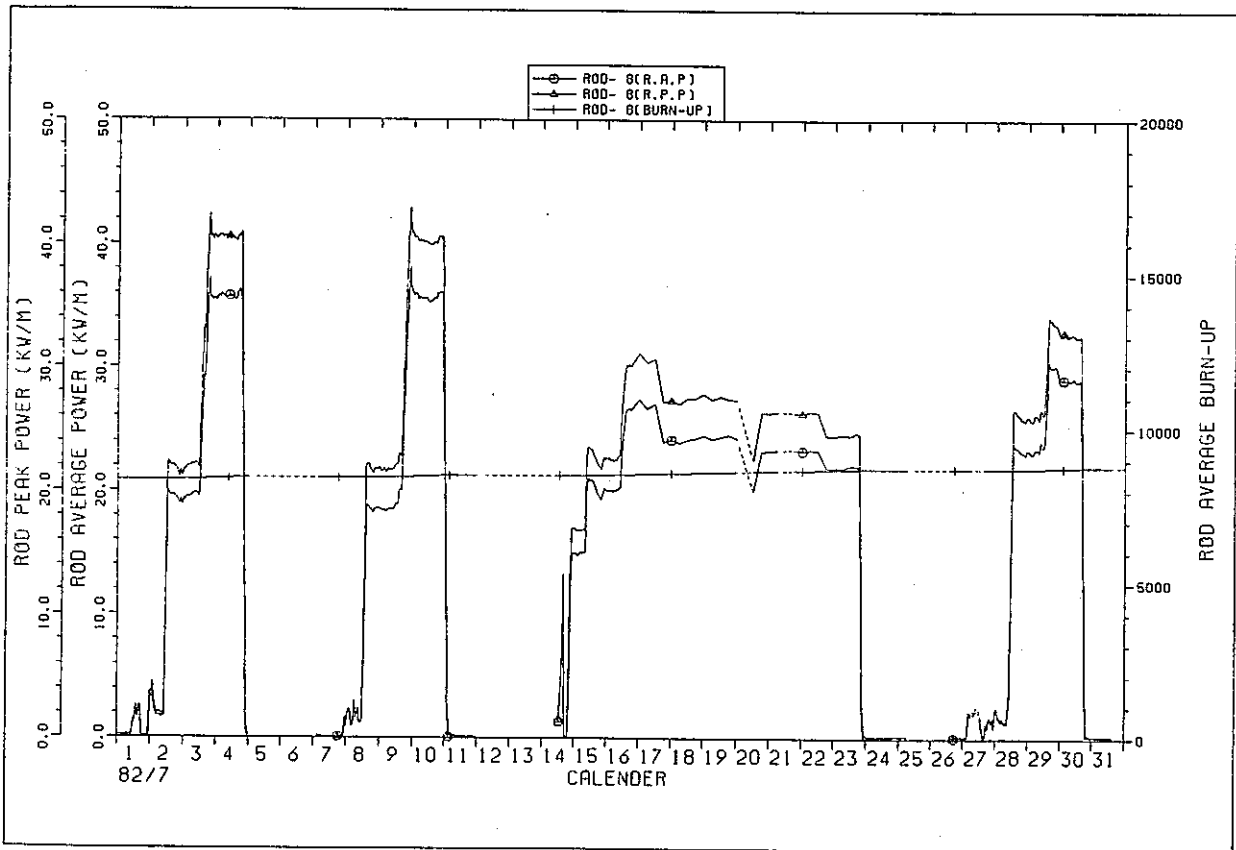

IFA529 ROD POWER HISTORY

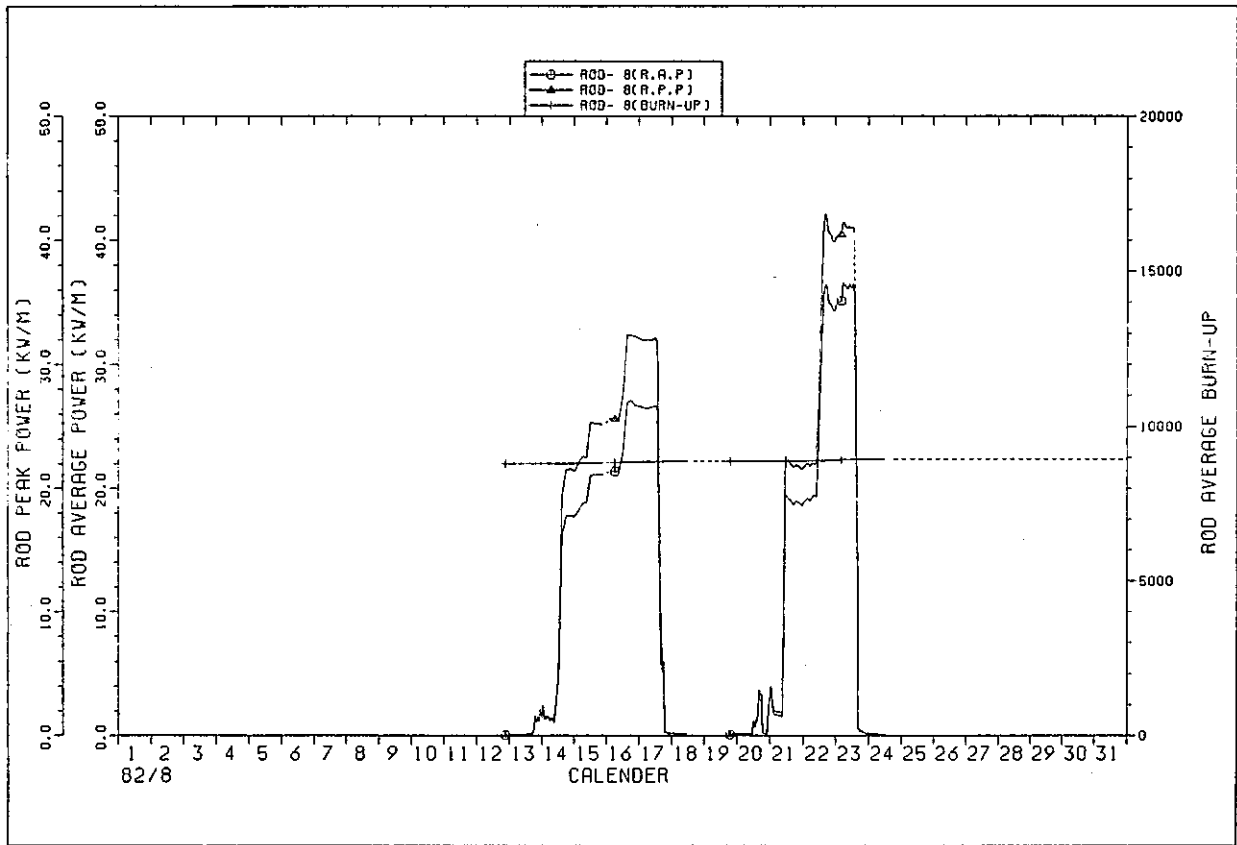

IFA529 ROD POWER HISTORY

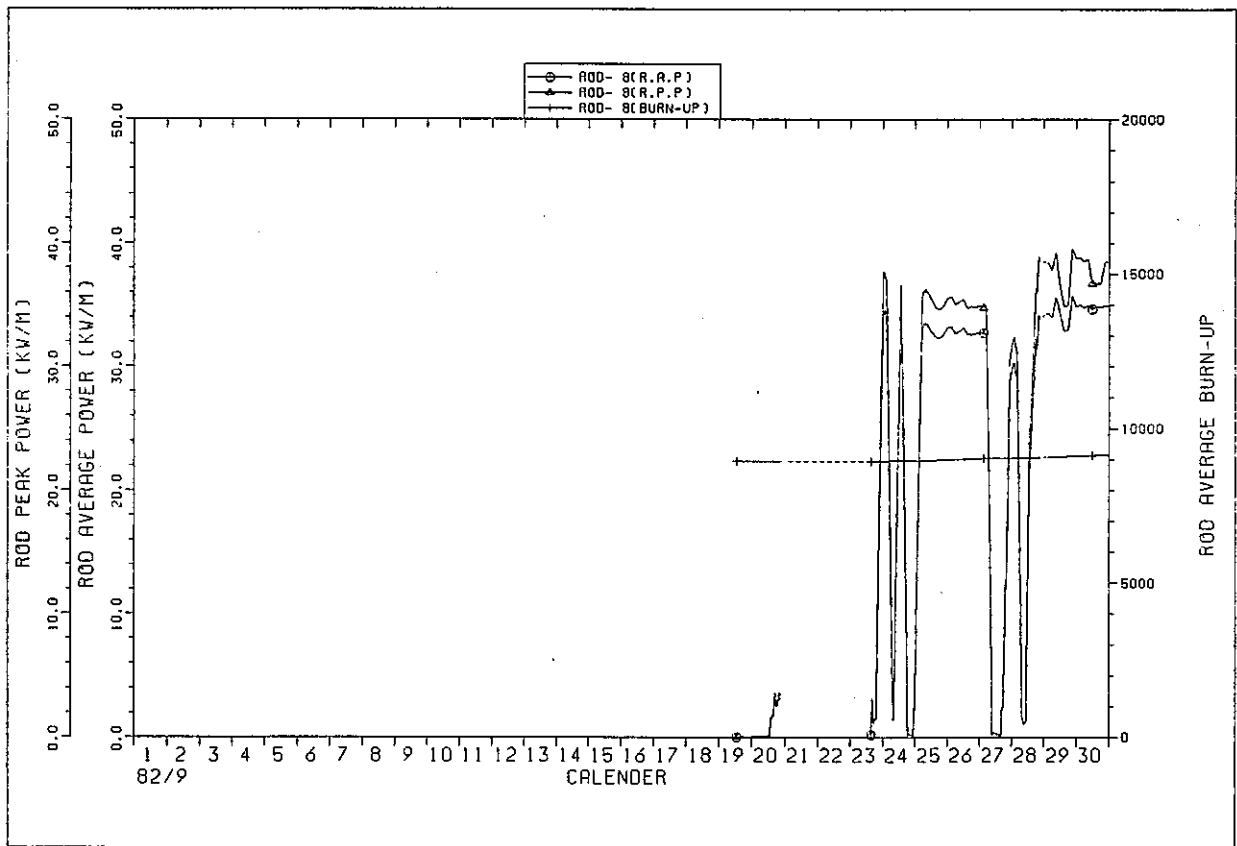

IFA529 ROD POWER HISTORY

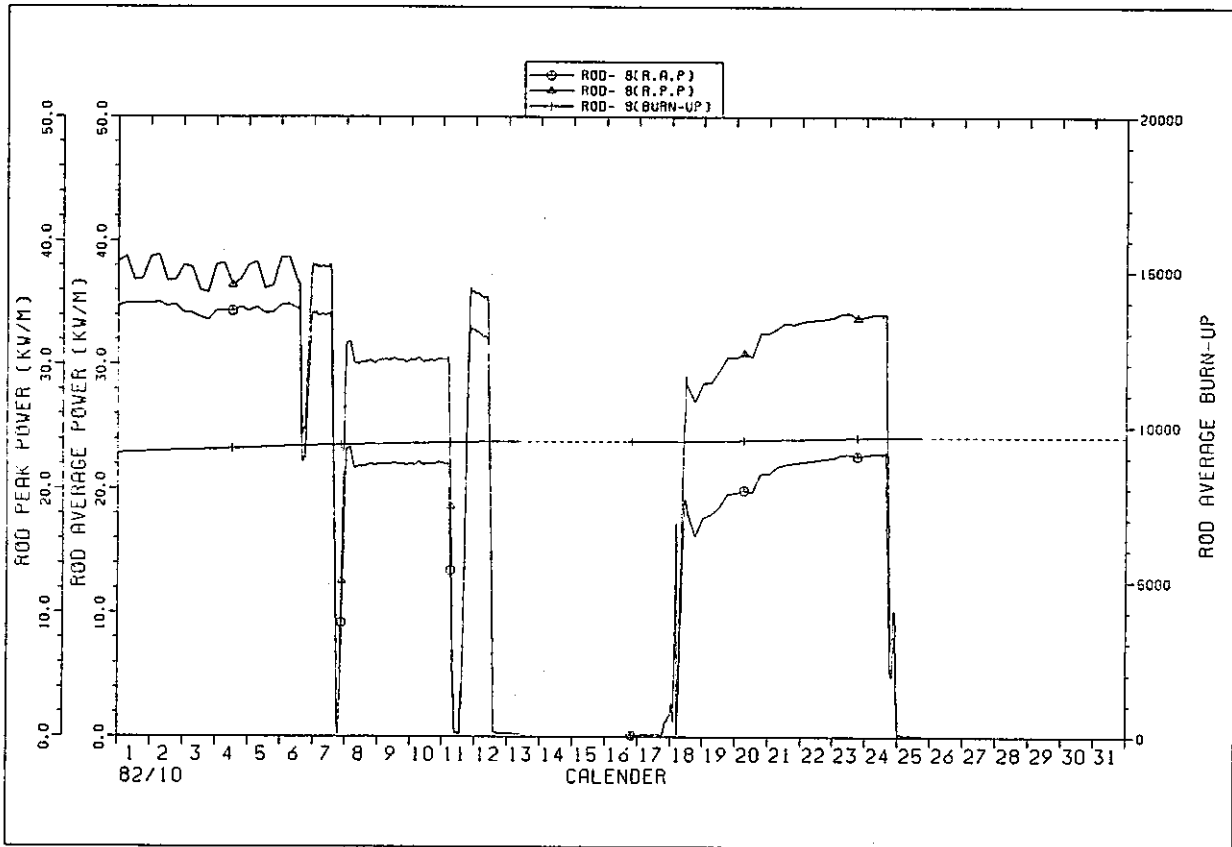

IFA529 ROD POWER HISTORY

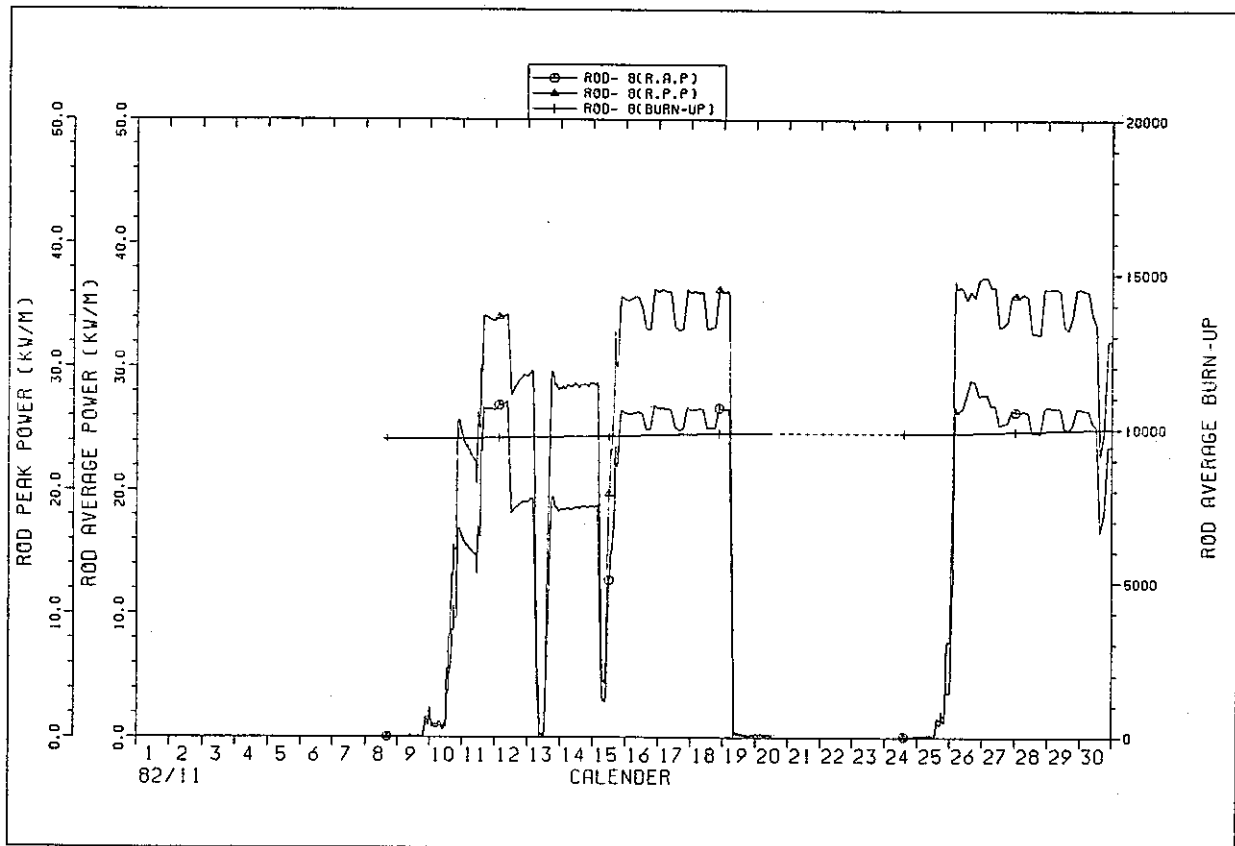

IFA529 ROD POWER HISTORY

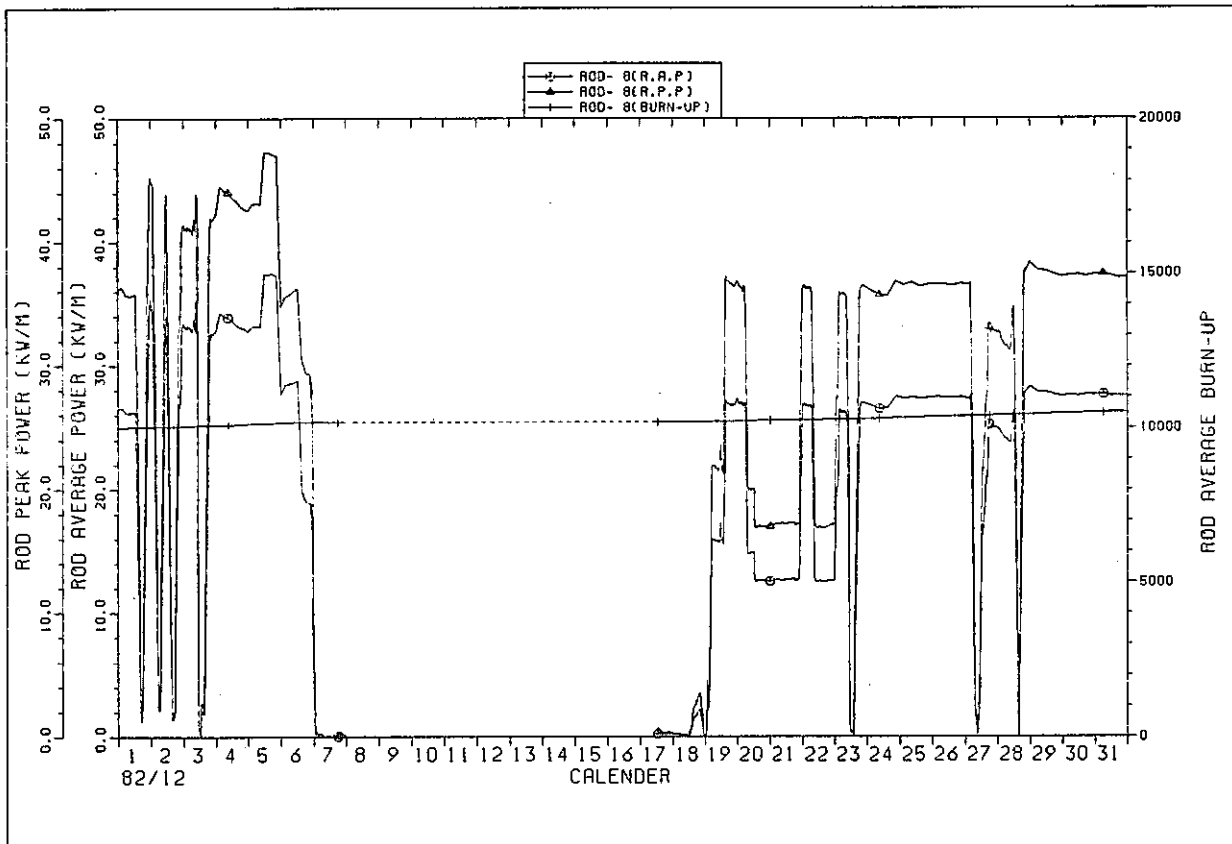

IFA529 ROD POWER HISTORY

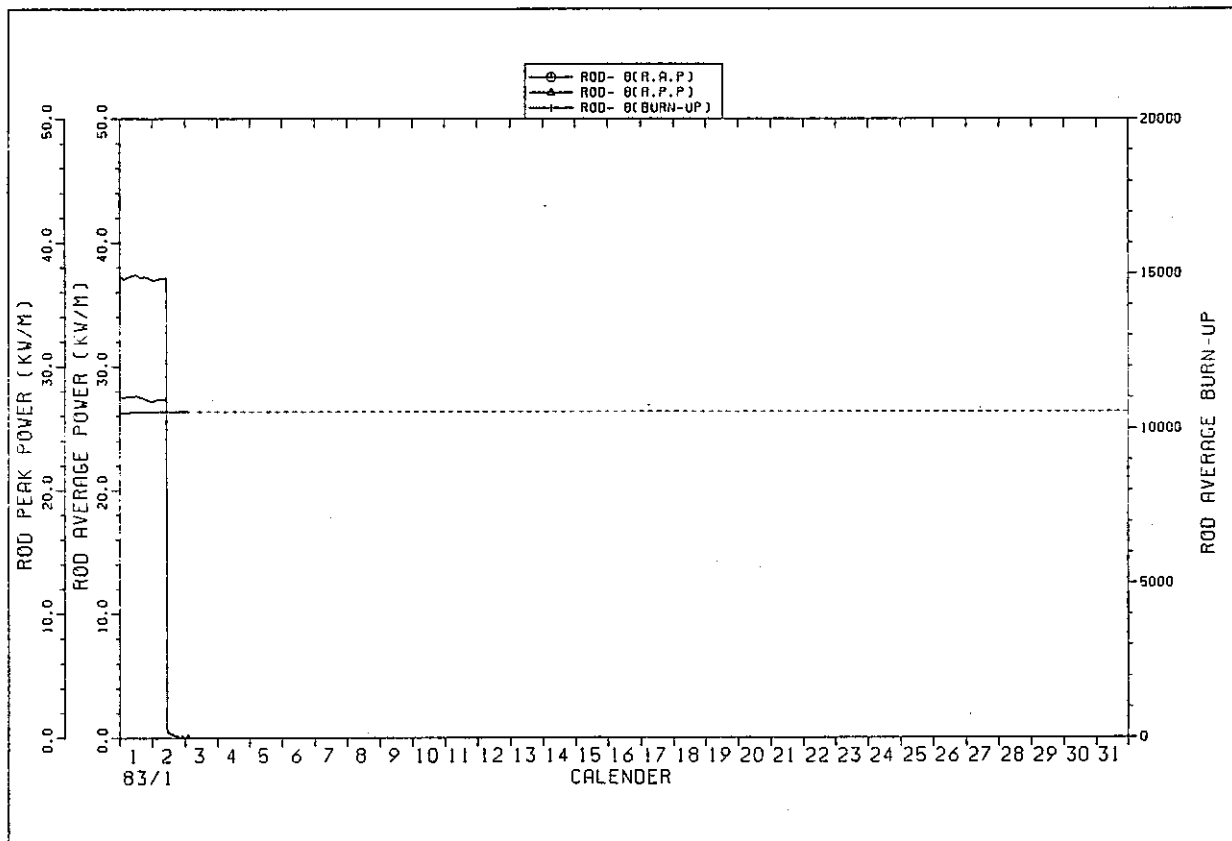

IFA529 ROD POWER HISTORY

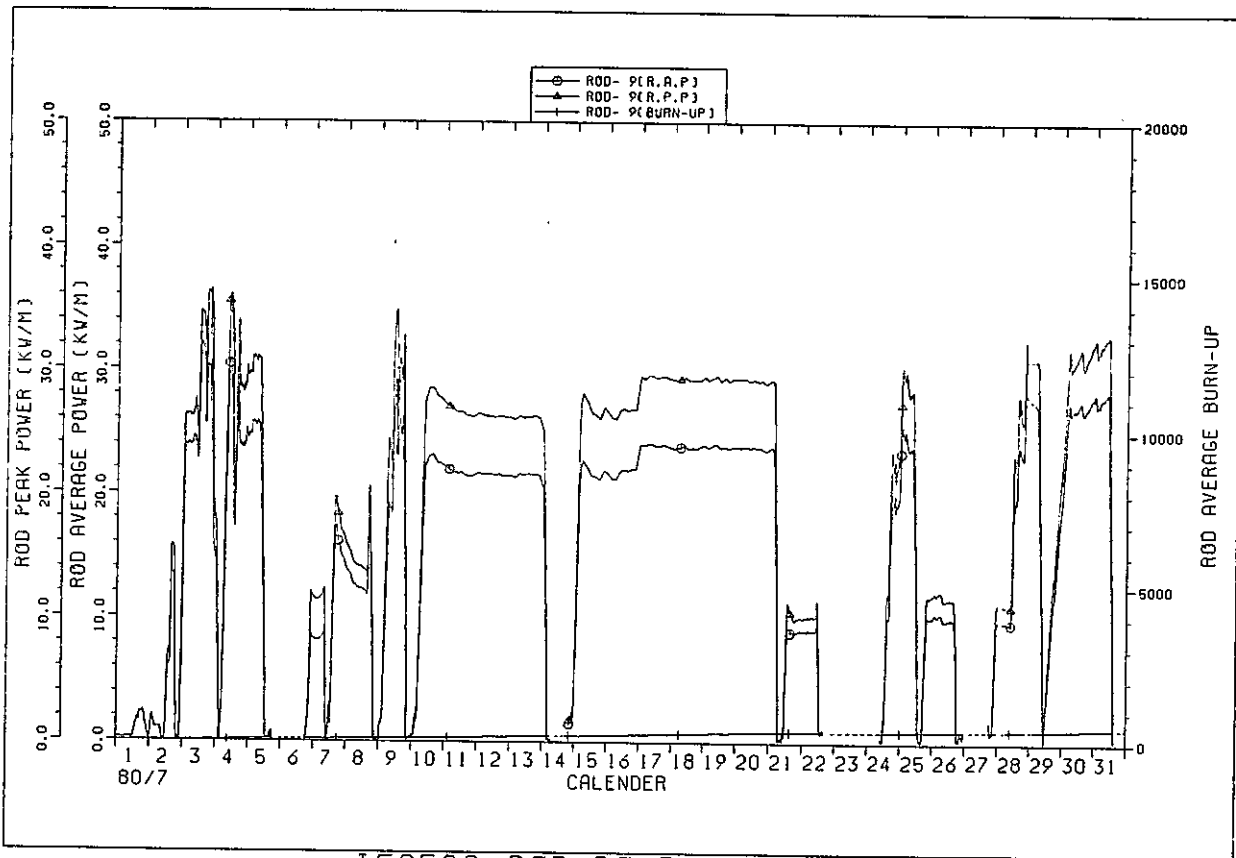

IFA529 ROD POWER HISTORY

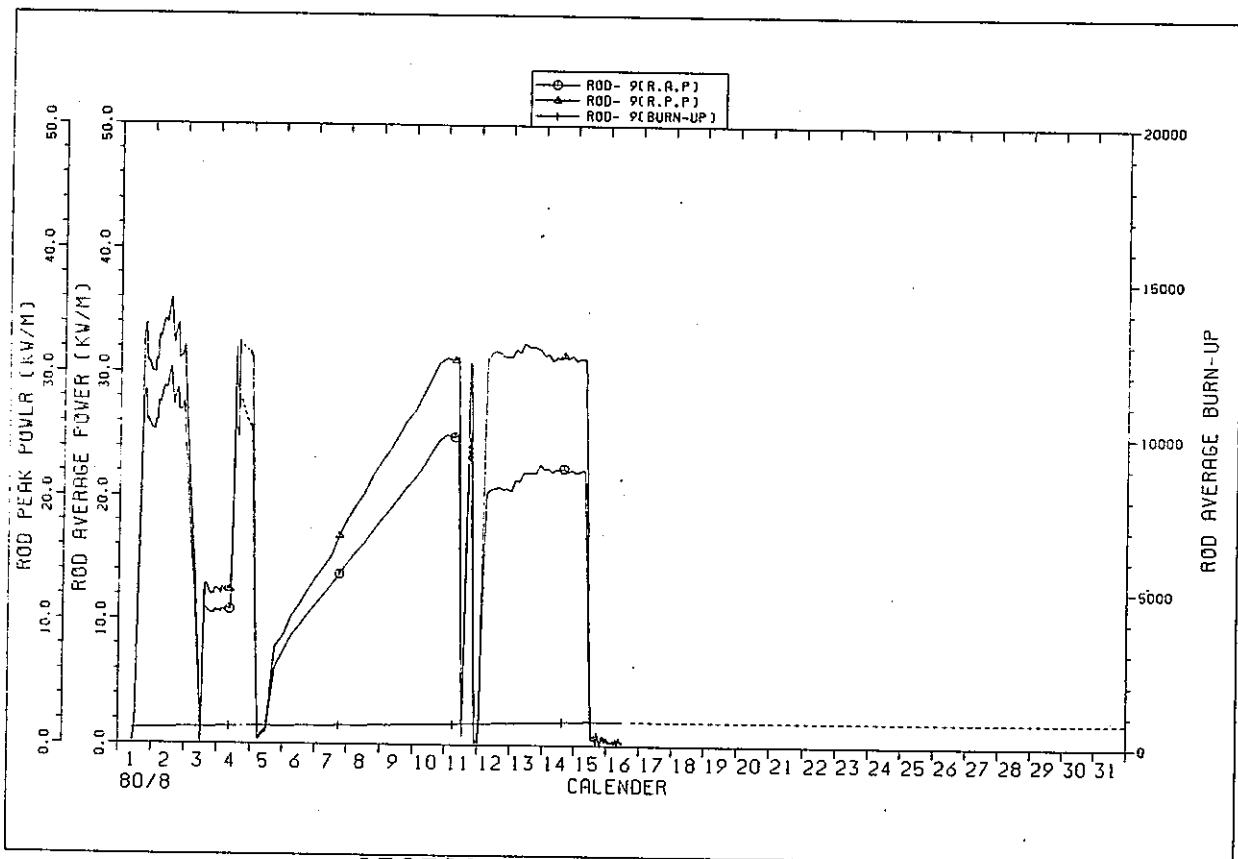

IFA529 ROD POWER HISTORY

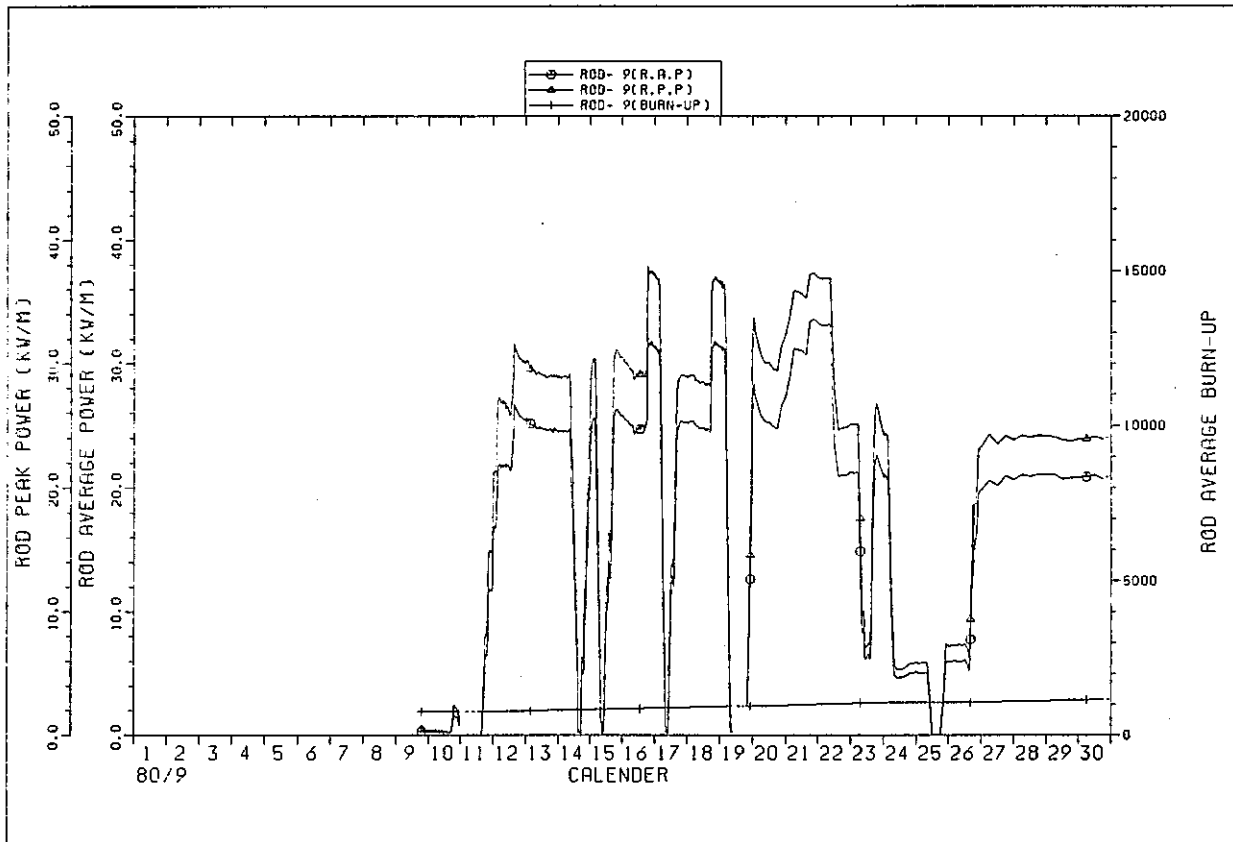

IFA529 ROD POWER HISTORY

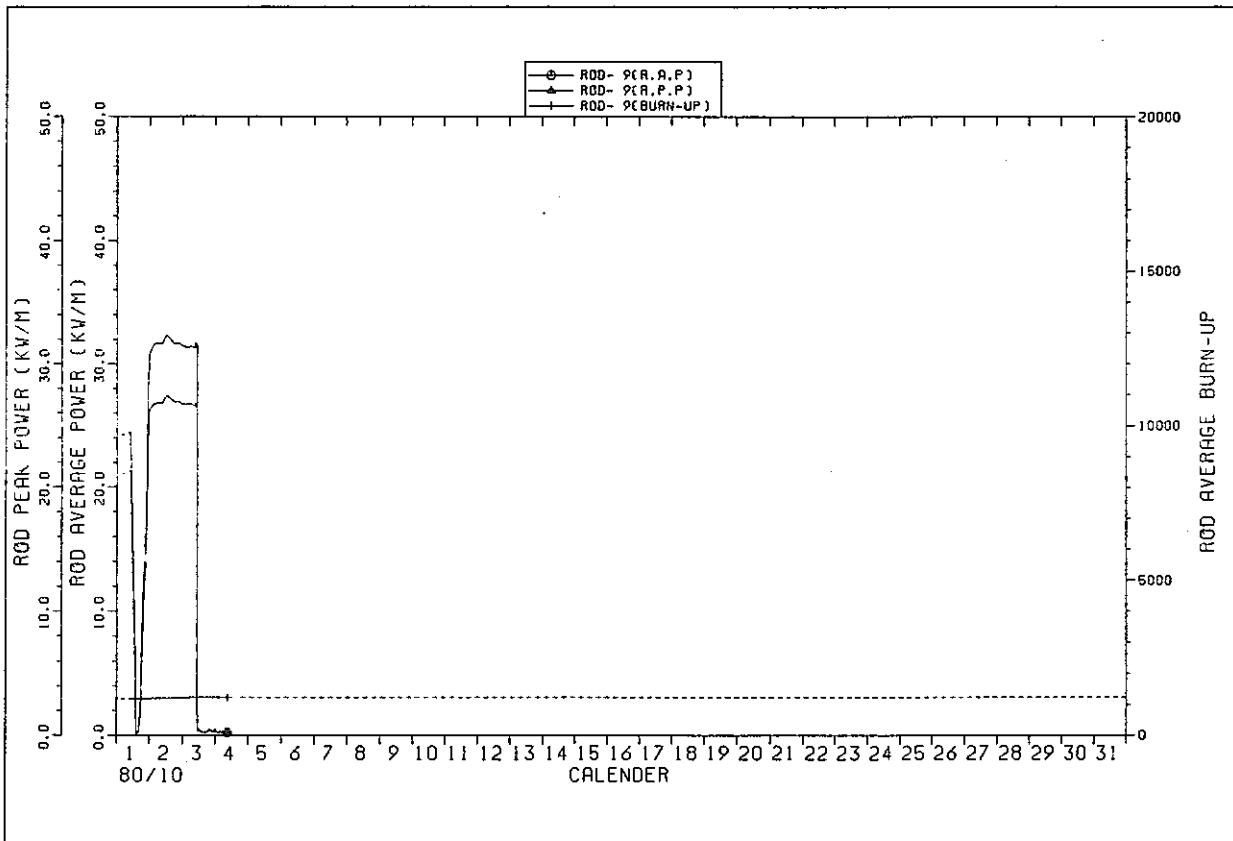

IFA529 ROD POWER HISTORY

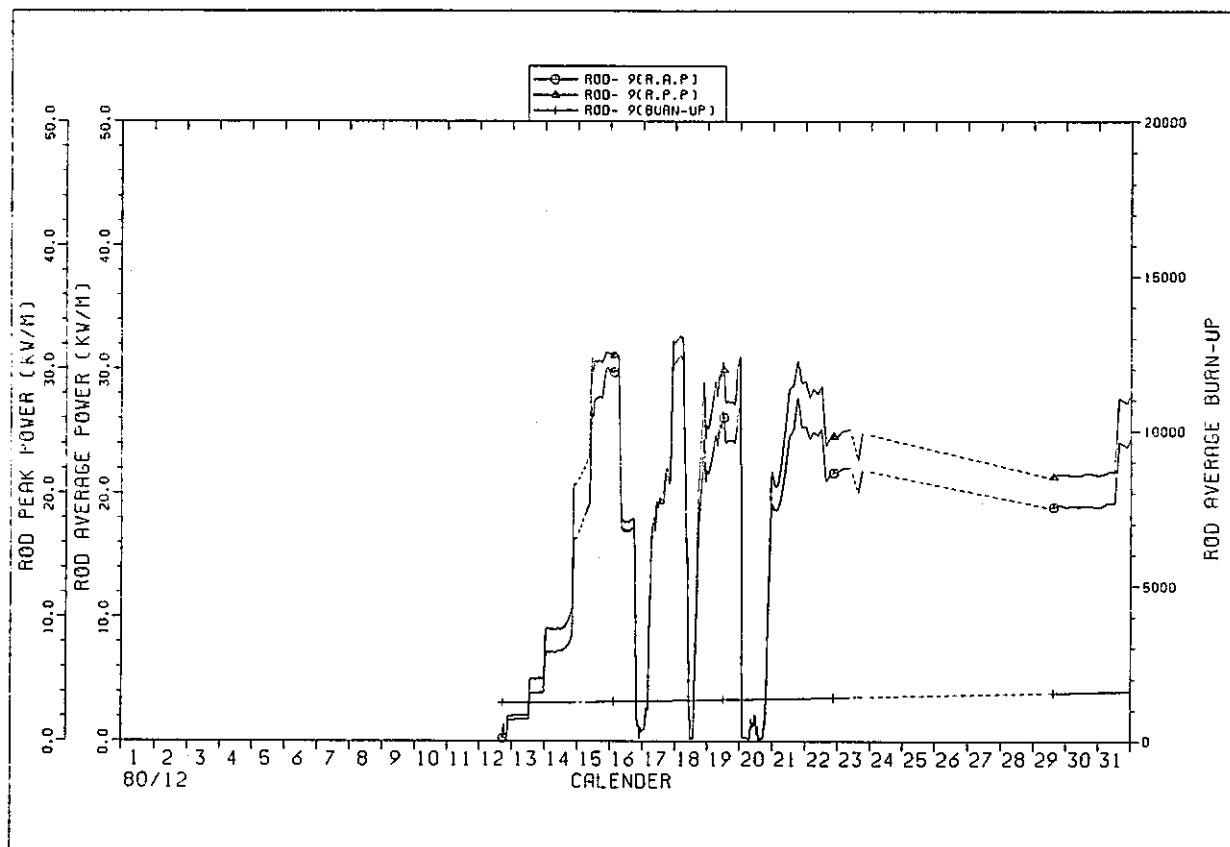

IF529 ROD POWER HISTORY

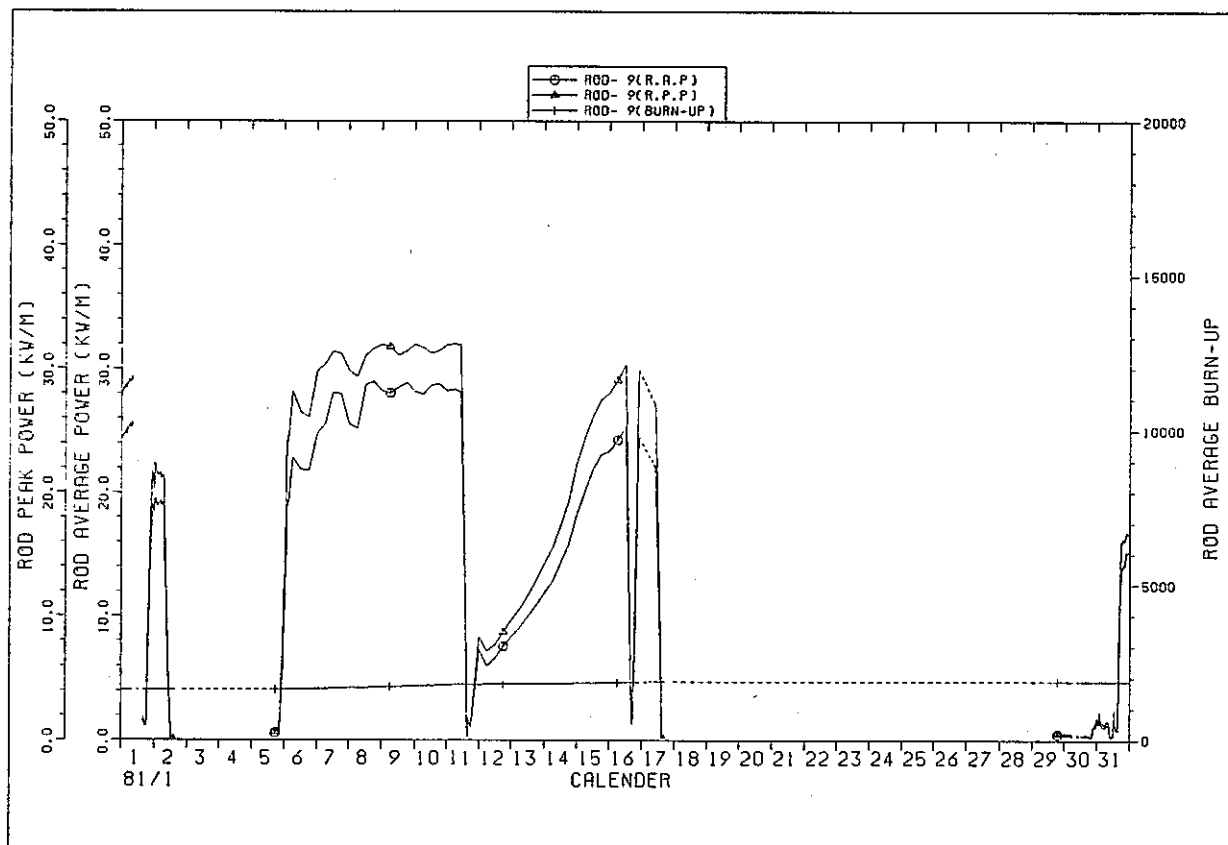

IF529 ROD POWER HISTORY

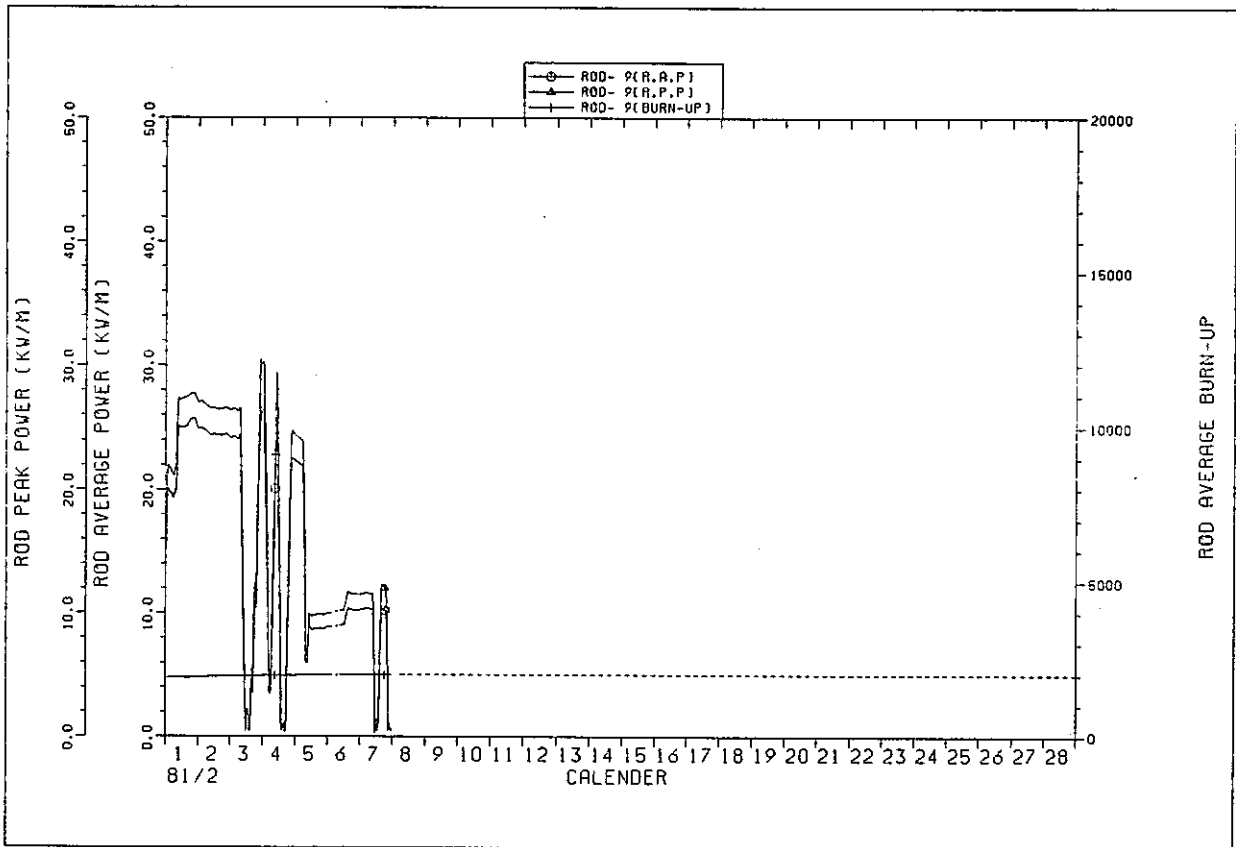

IFA529 ROD POWER HISTORY

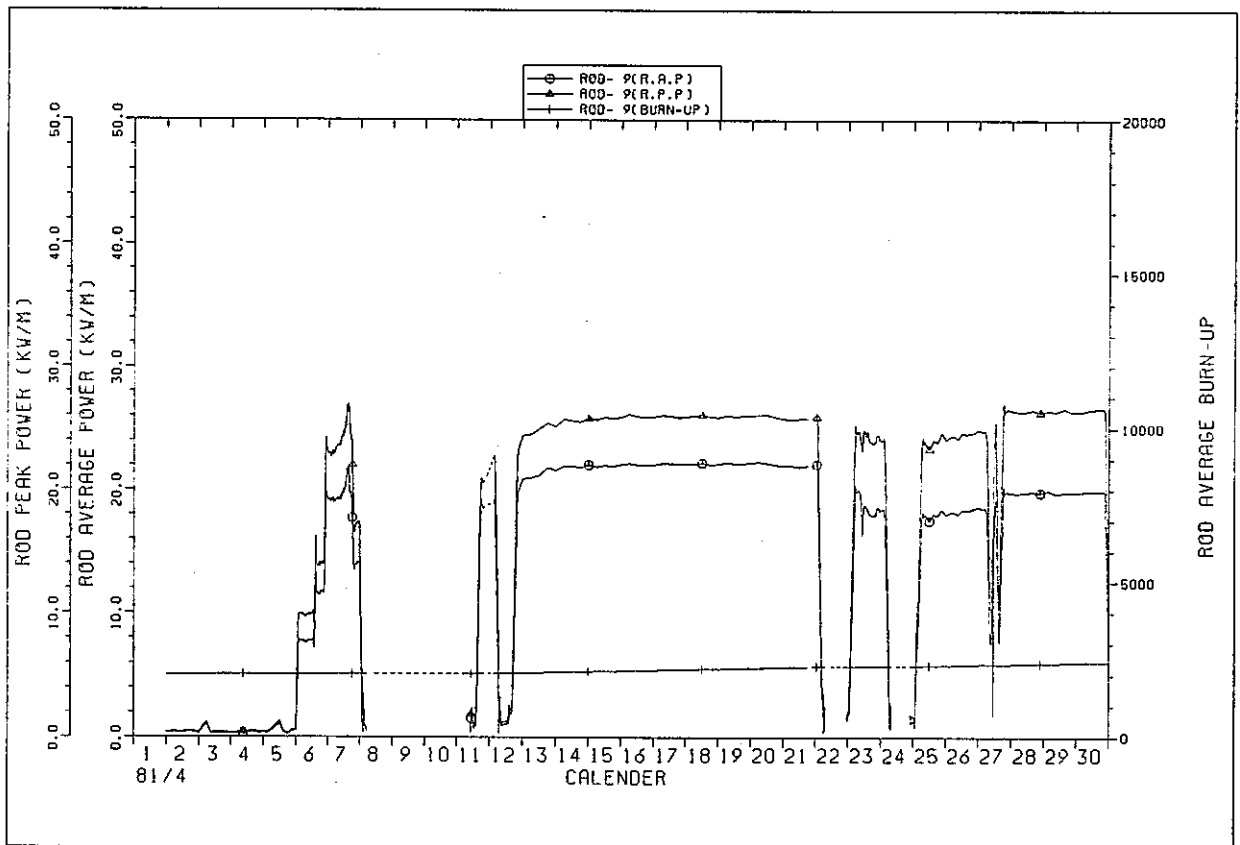

IFA529 ROD POWER HISTORY

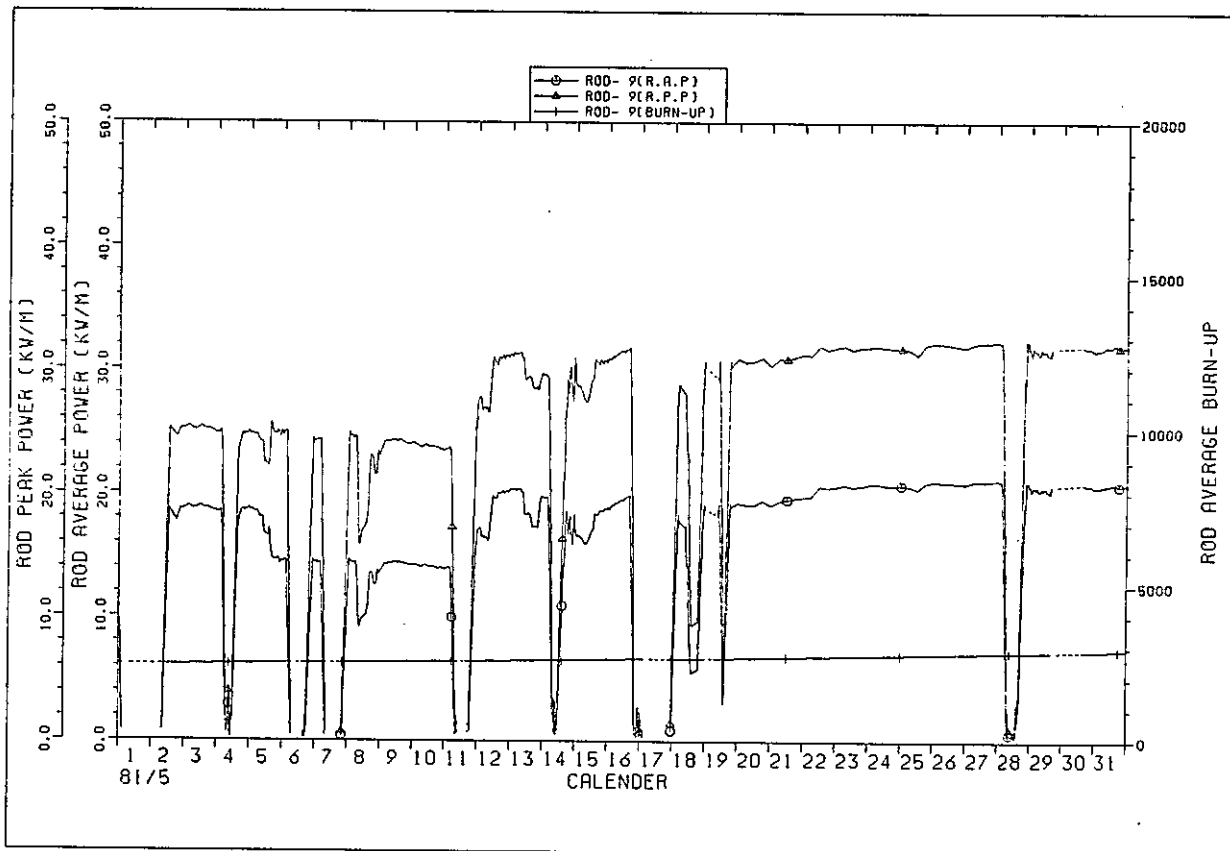

IFA529 ROD POWER HISTORY

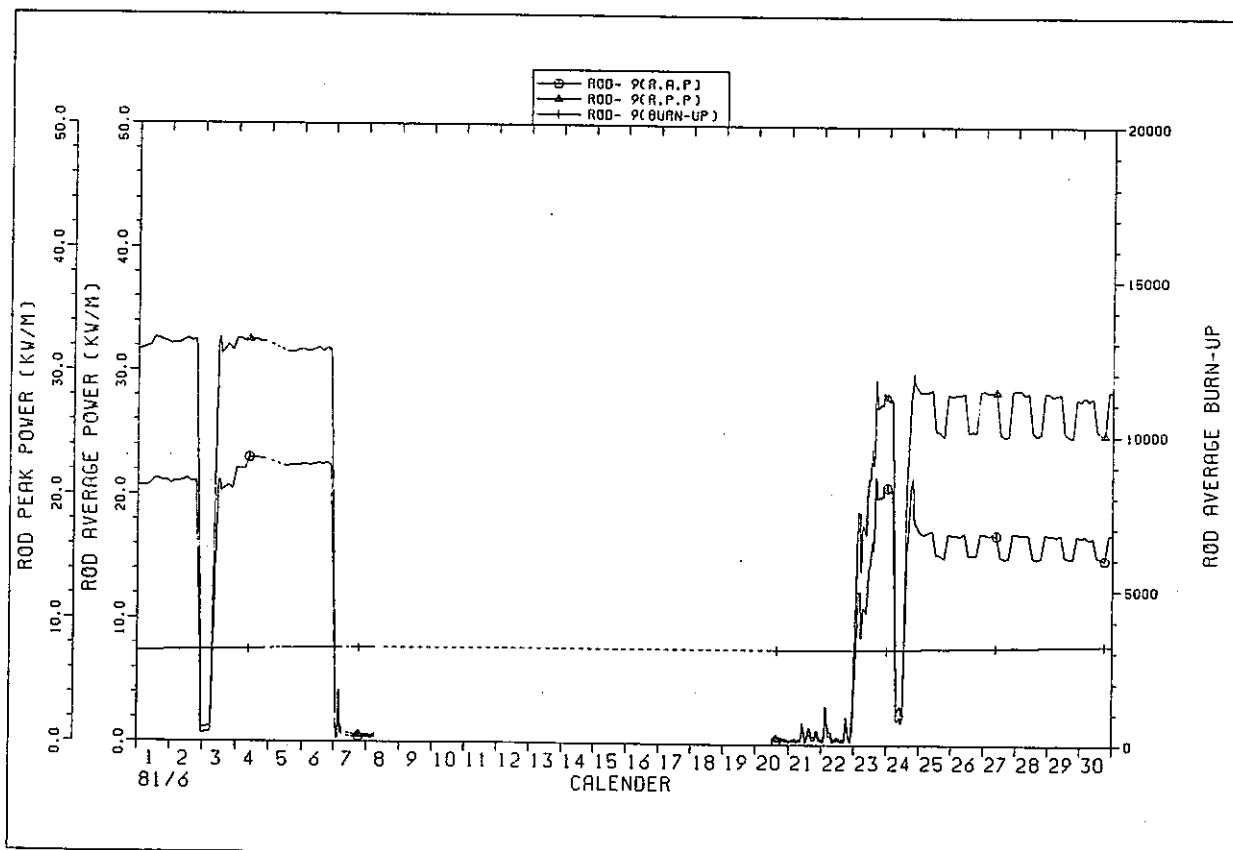

IFA529 ROD POWER HISTORY

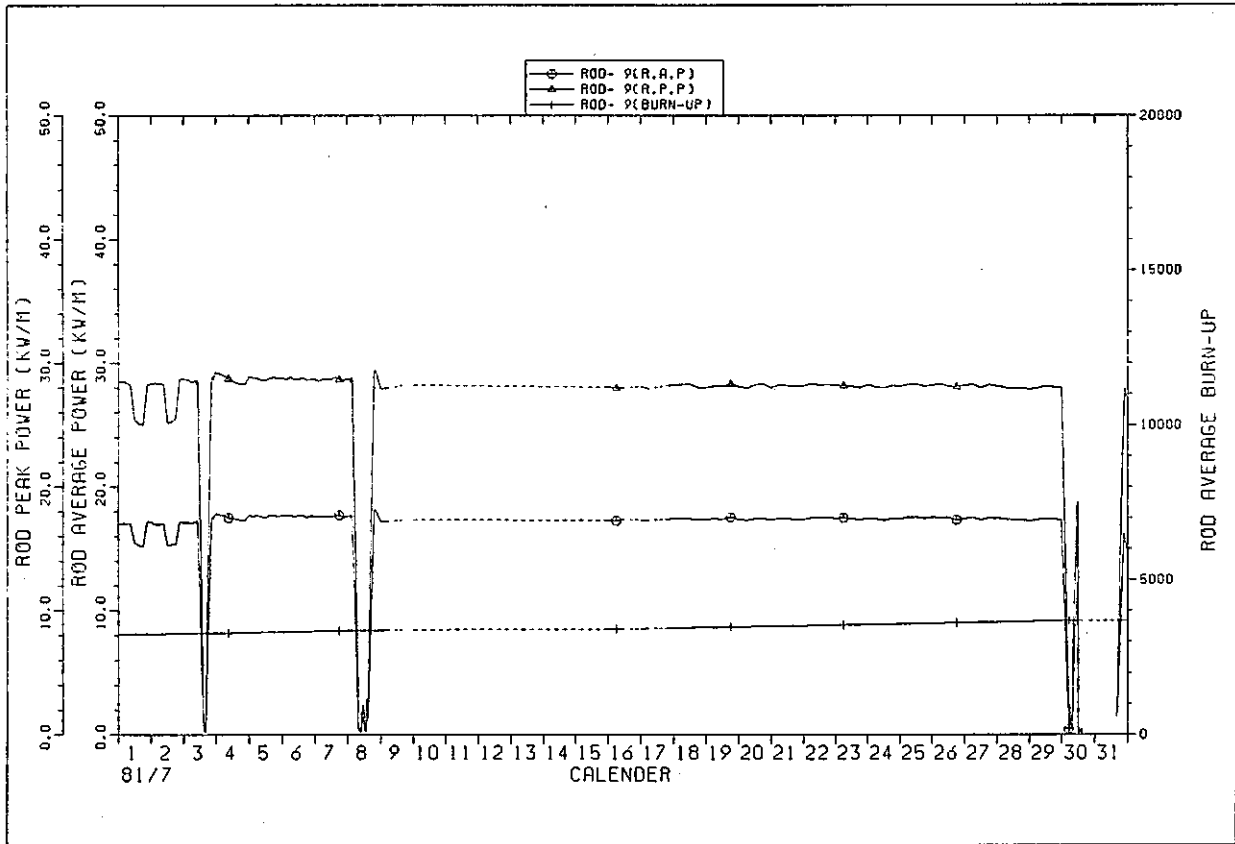

IFA529 ROD POWER HISTORY

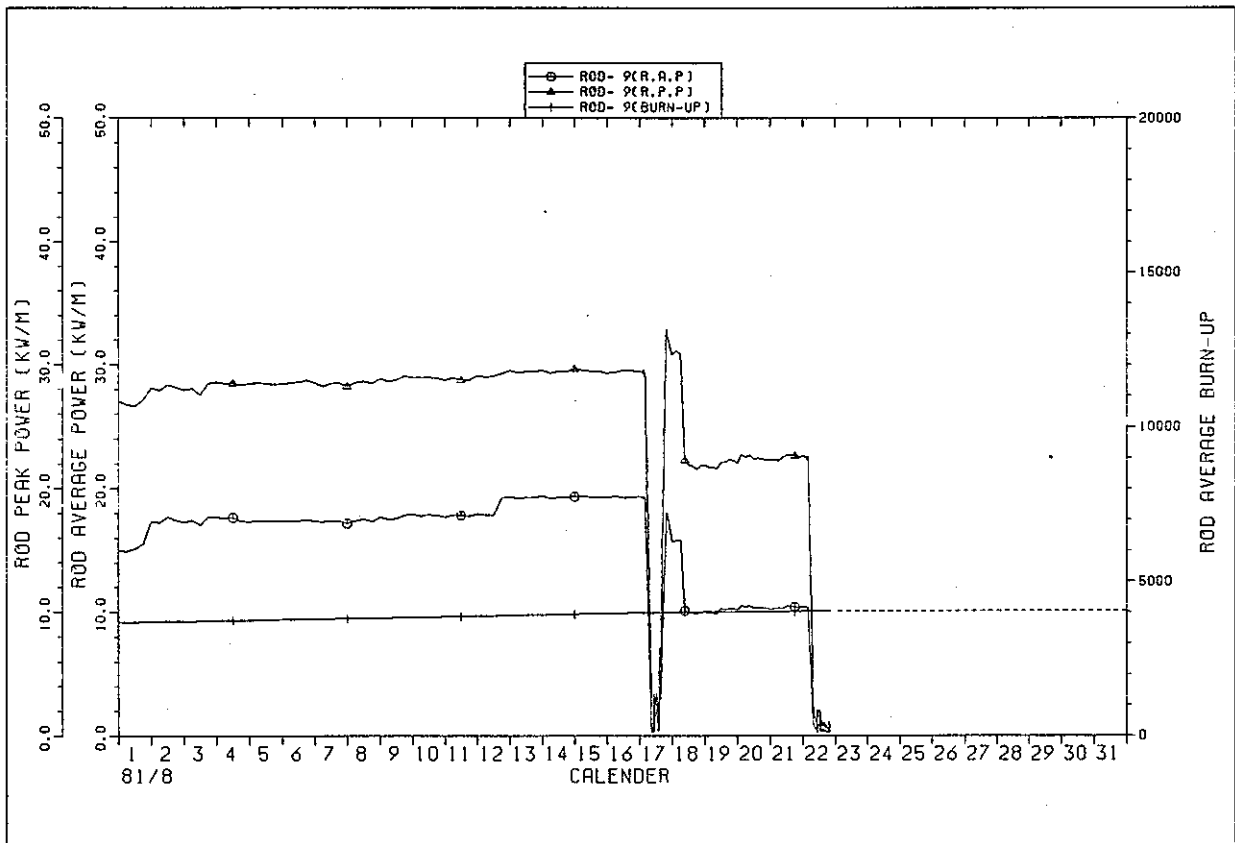

IFA529 ROD POWER HISTORY

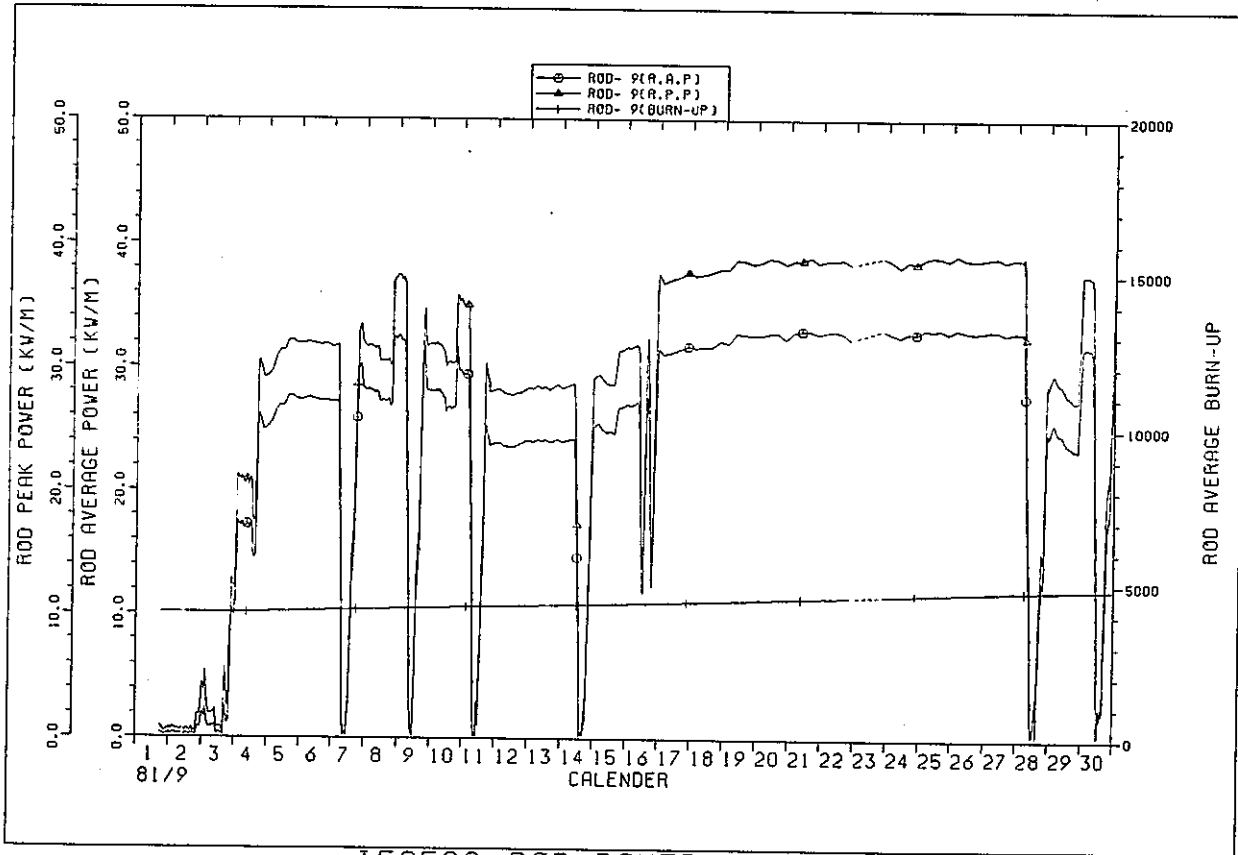

IFA529 ROD POWER HISTORY

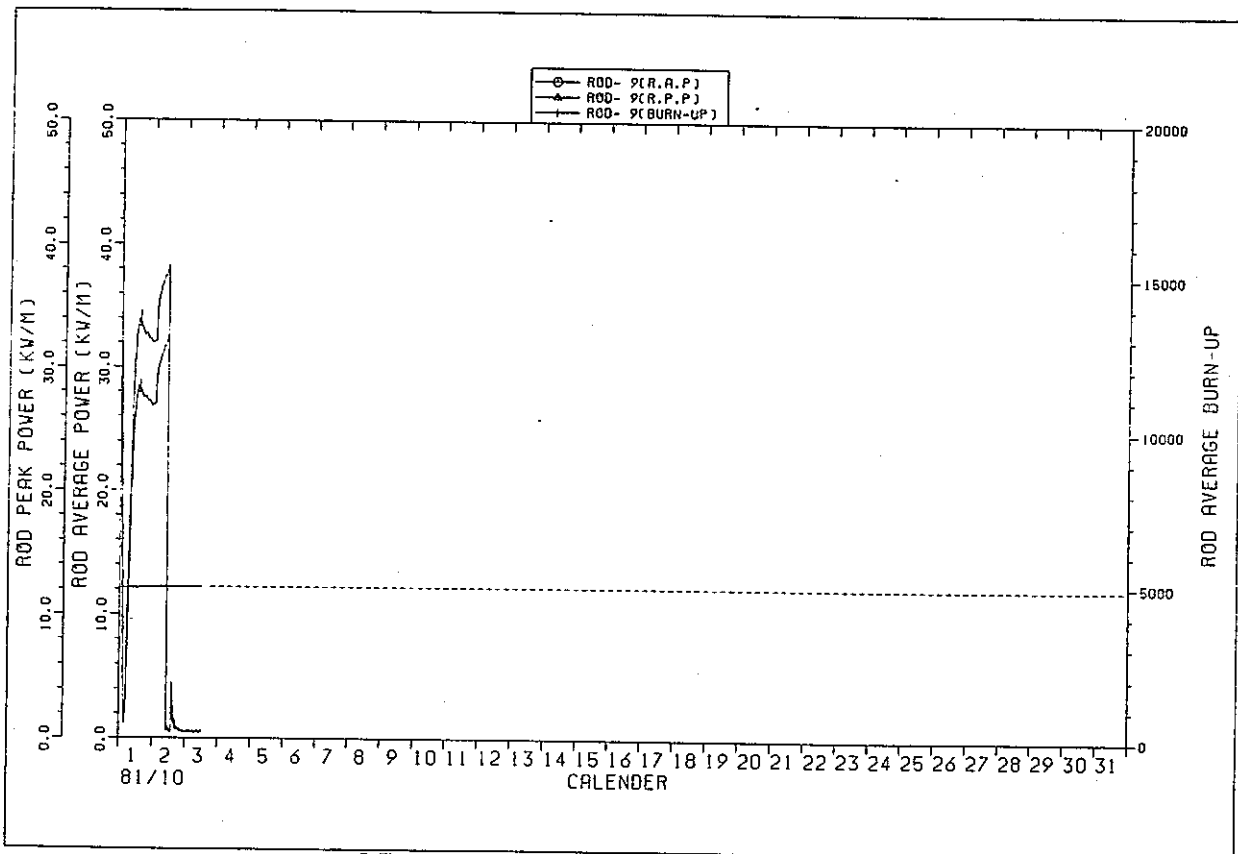

IFA529 ROD POWER HISTORY

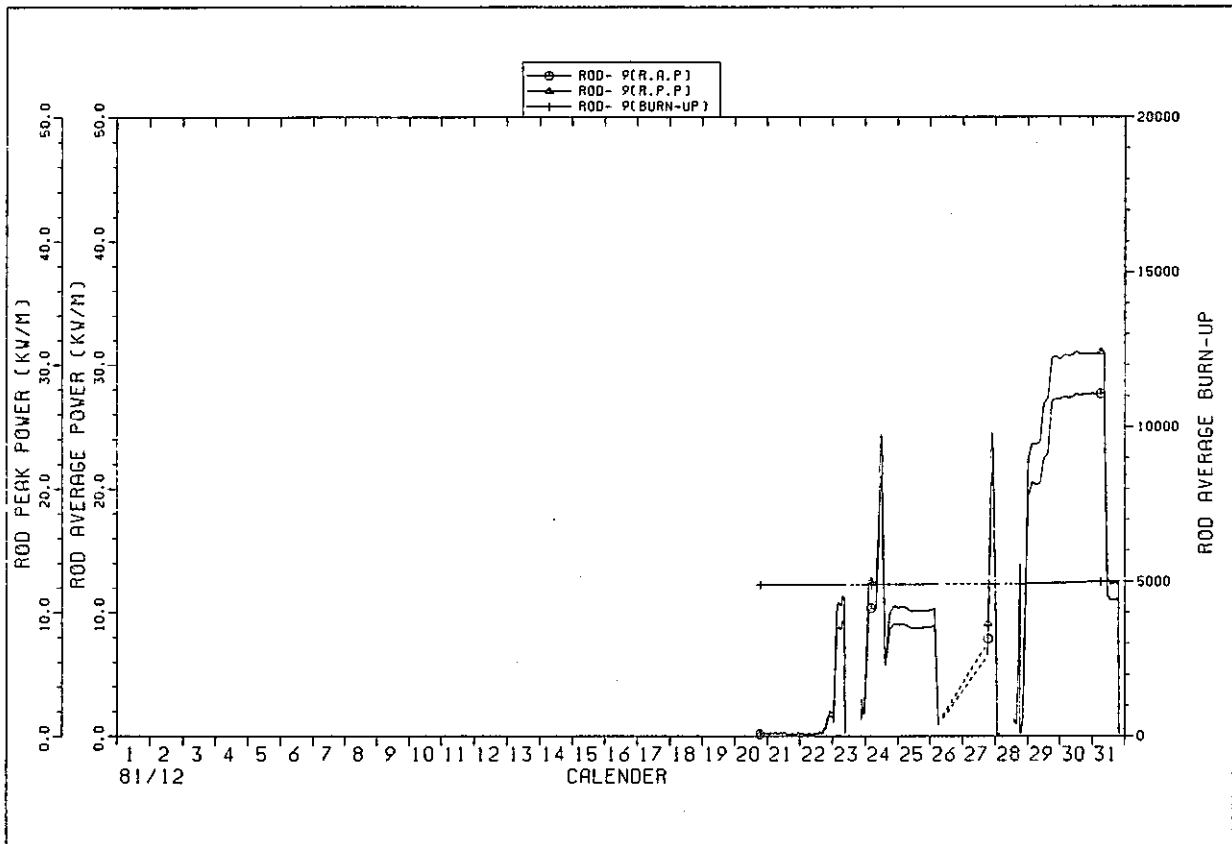

IFA529 ROD POWER HISTORY

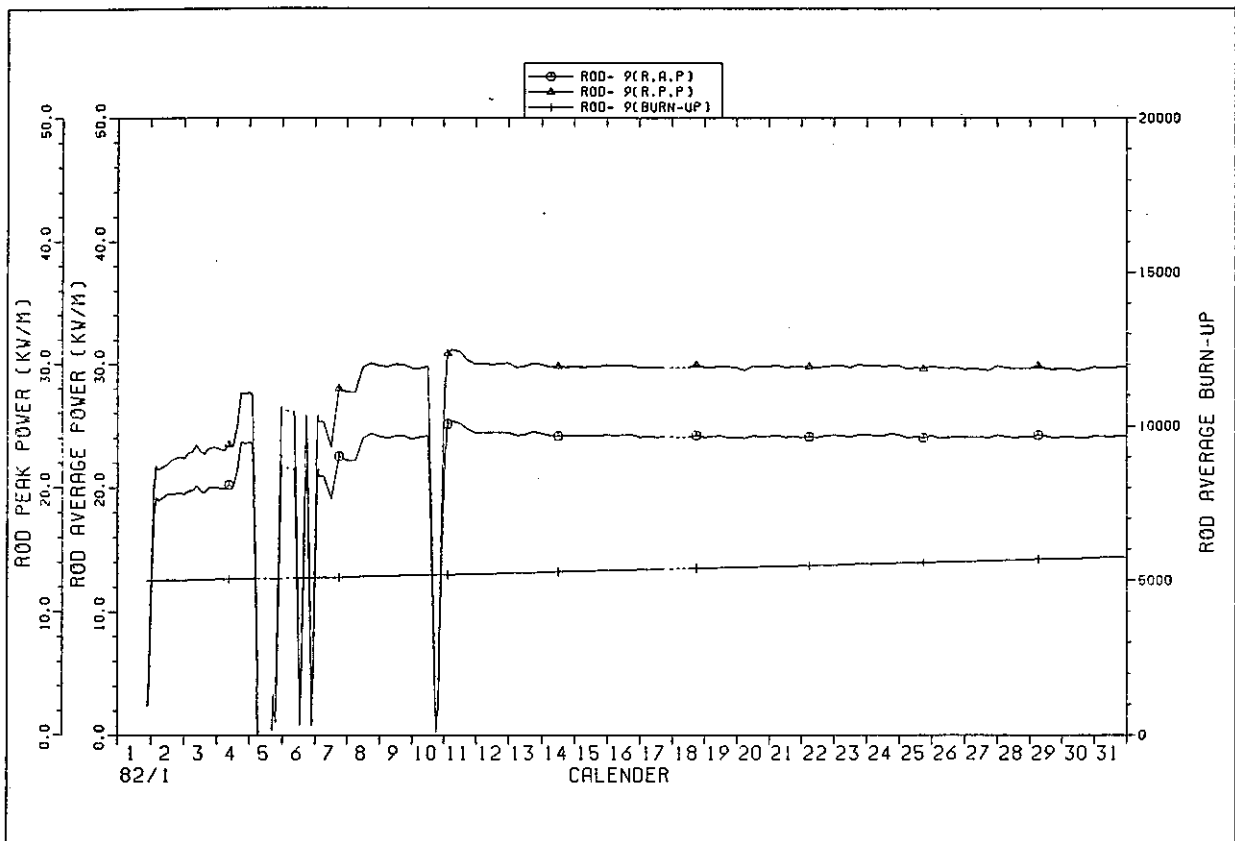

IFA529 ROD POWER HISTORY

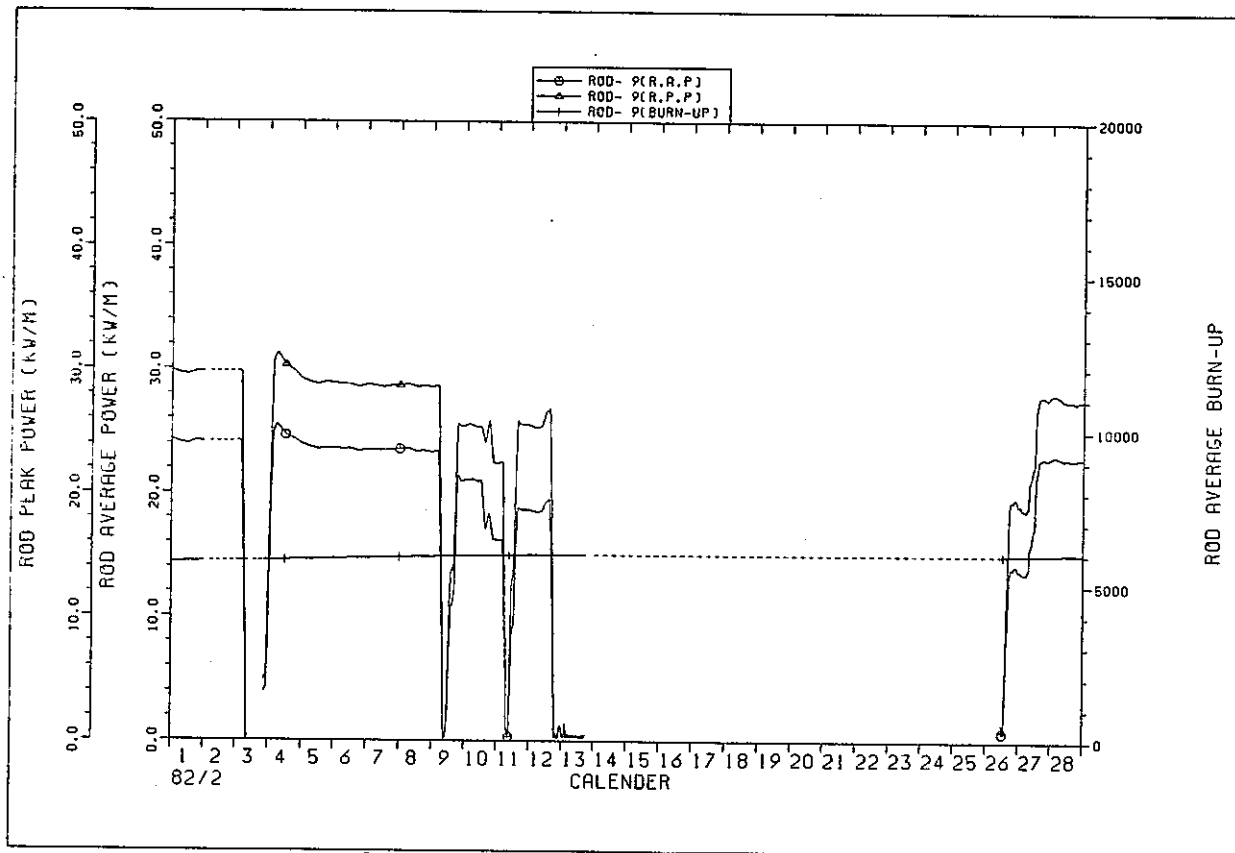

IFA529 ROD POWER HISTORY

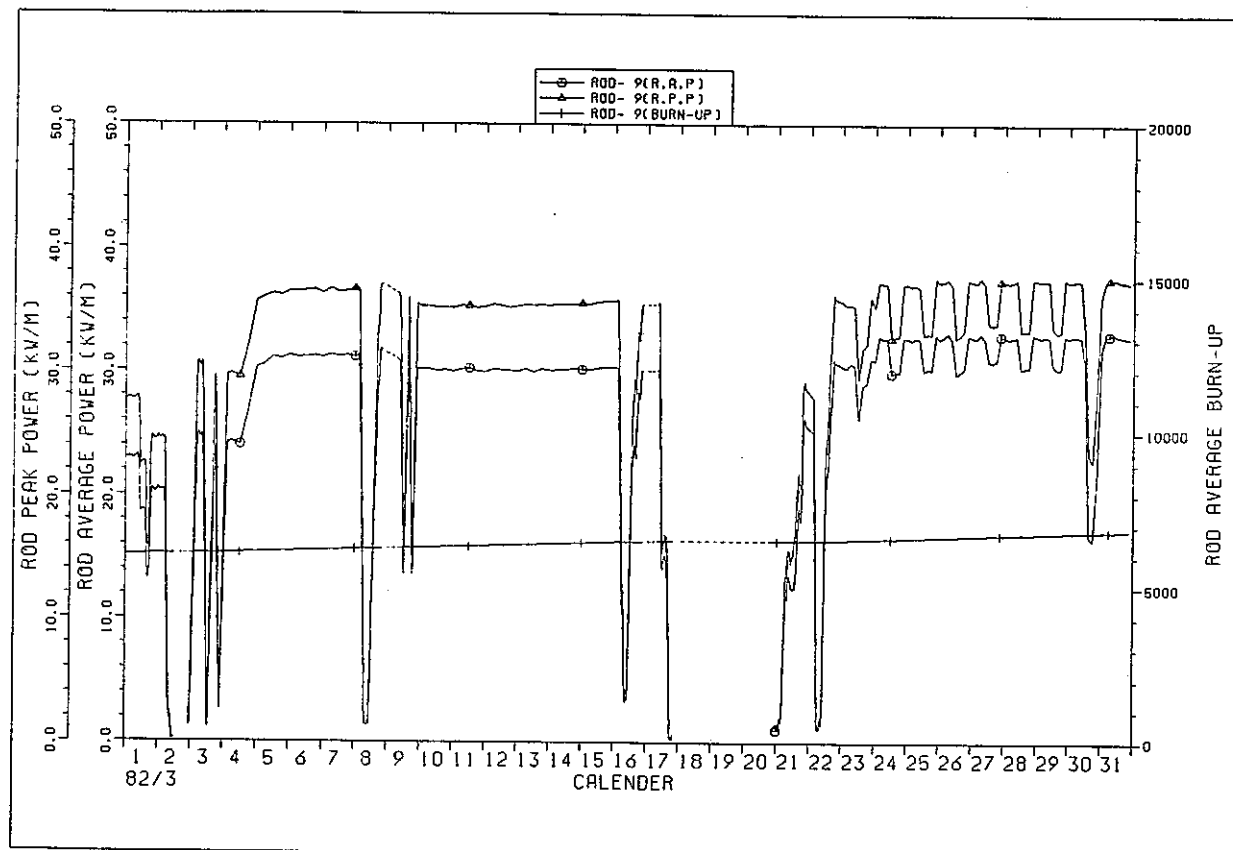

IFA529 ROD POWER HISTORY

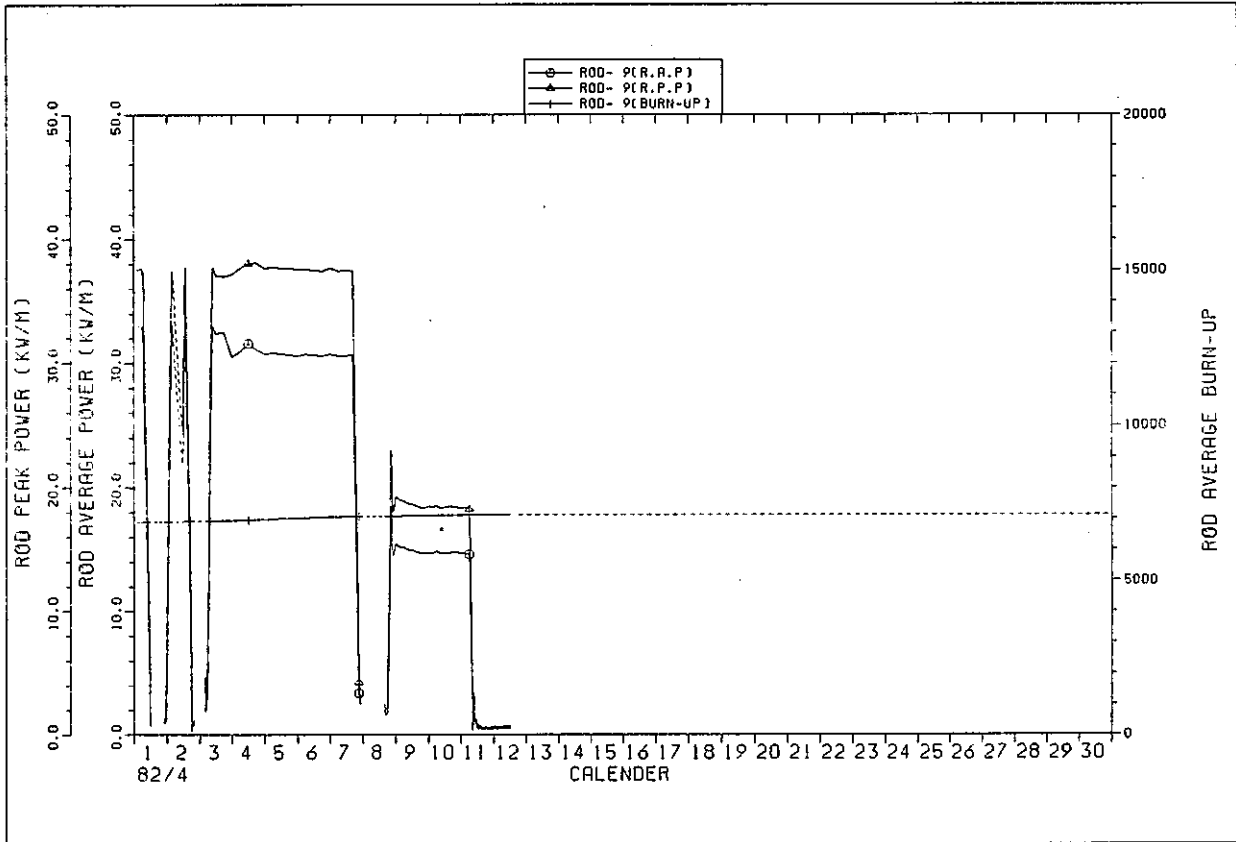

IFA529 ROD POWER HISTORY

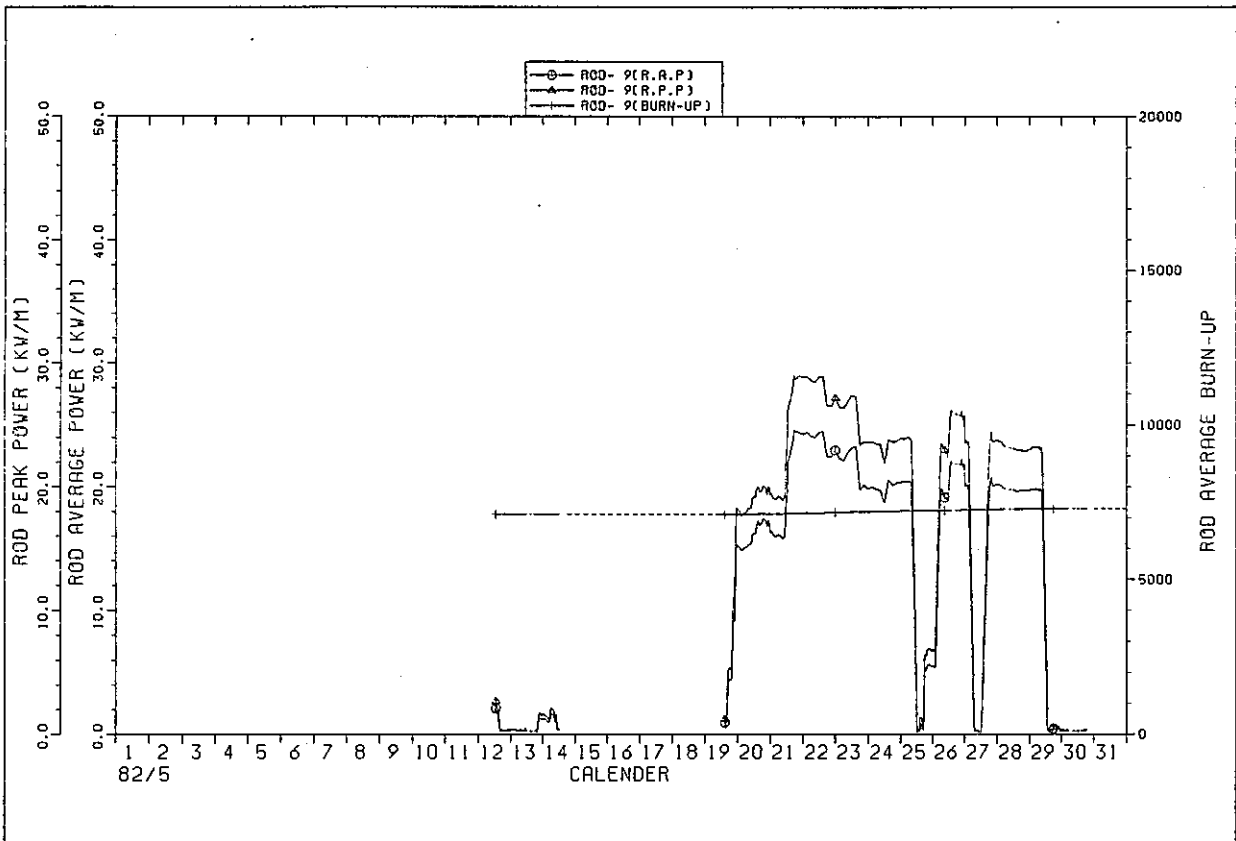

IFA529 ROD POWER HISTORY

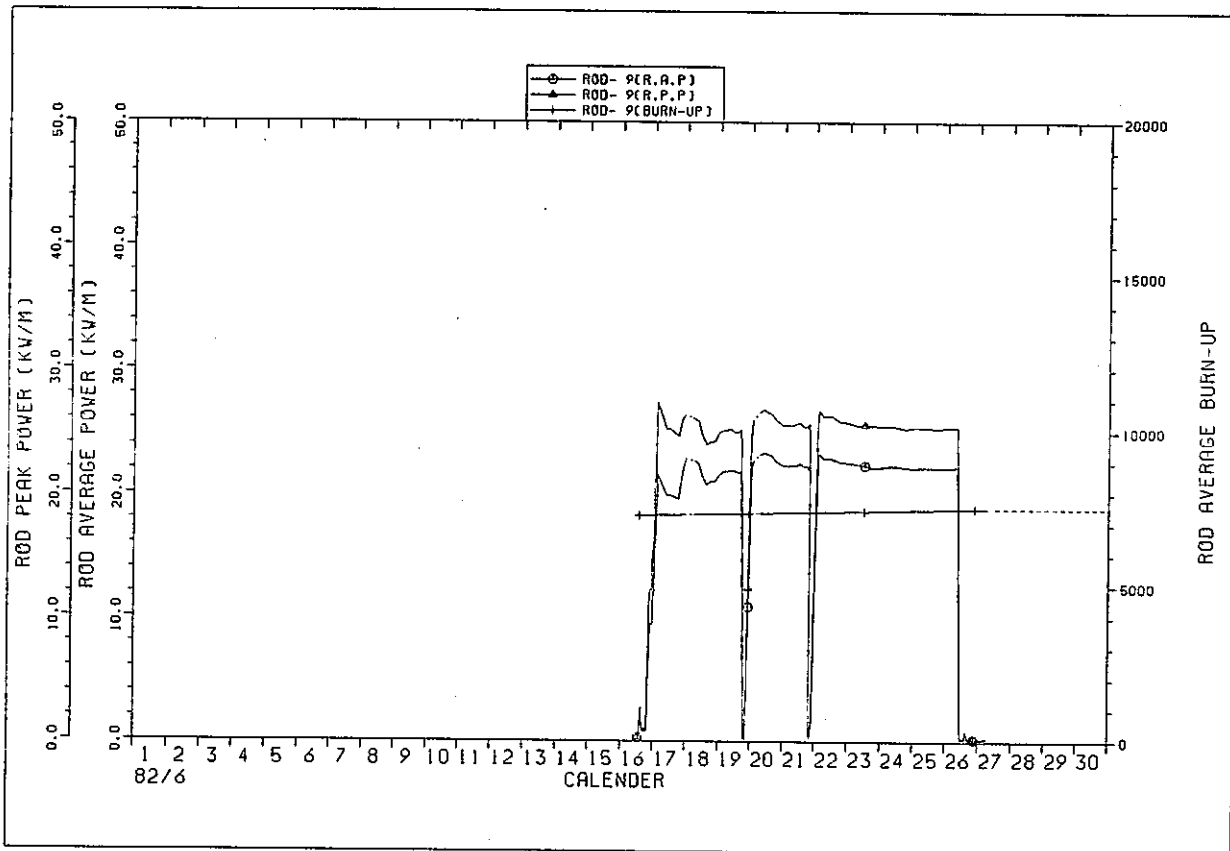

IFA529 ROD POWER HISTORY

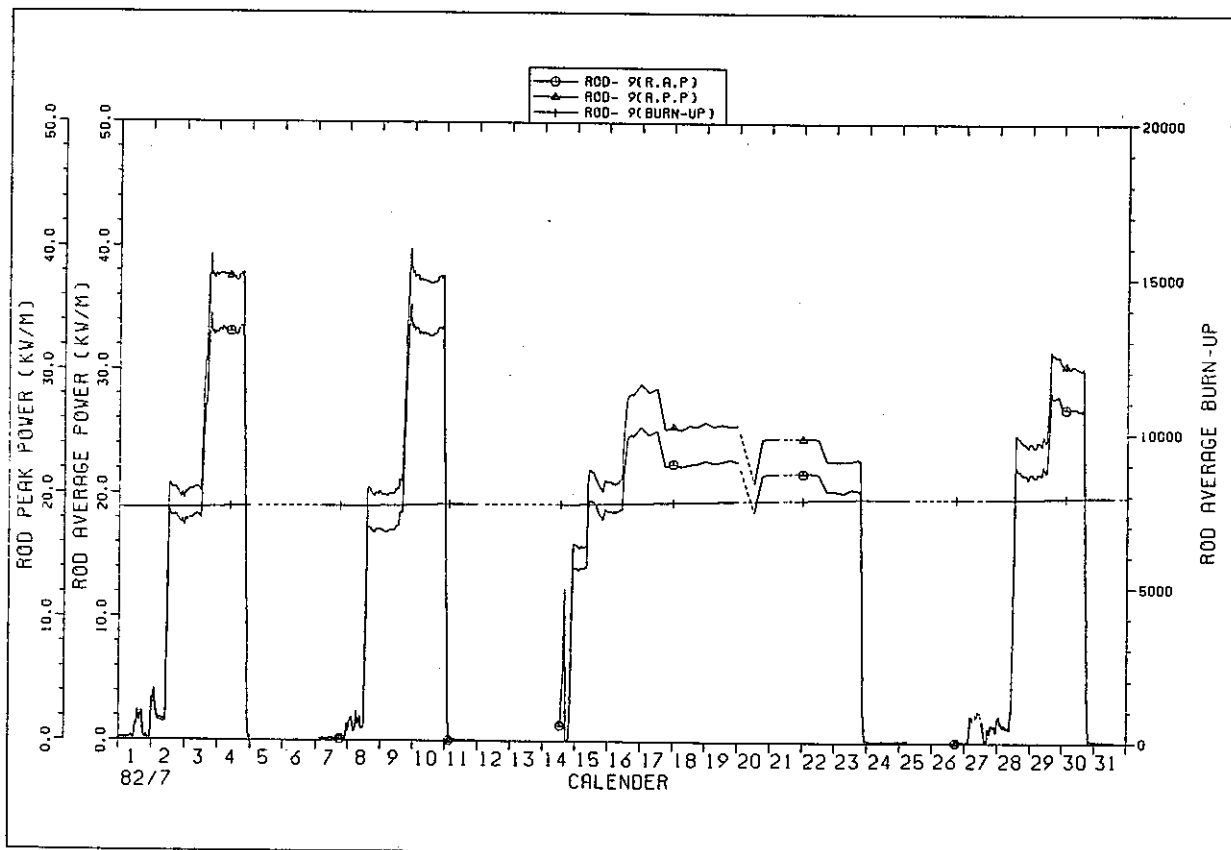

IFA529 ROD POWER HISTORY

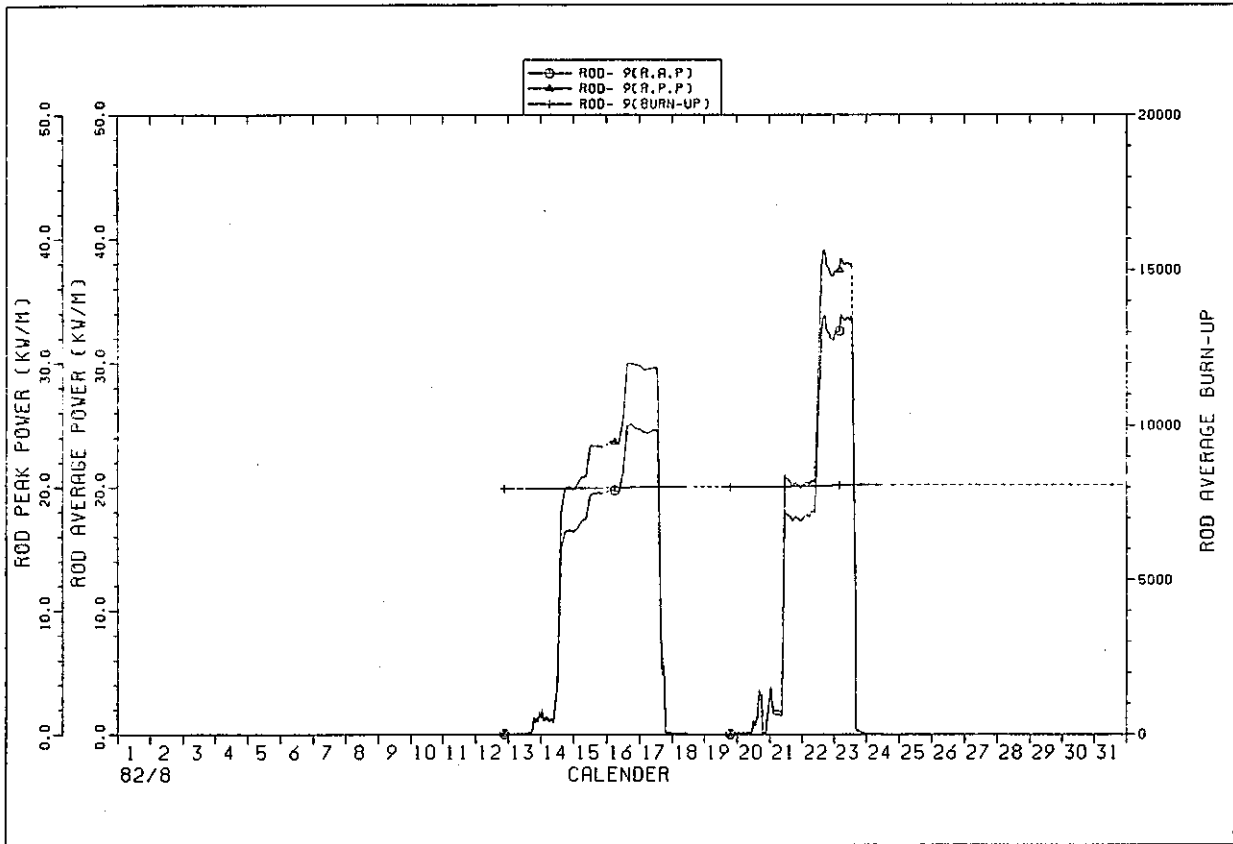

IFA529 ROD POWER HISTORY

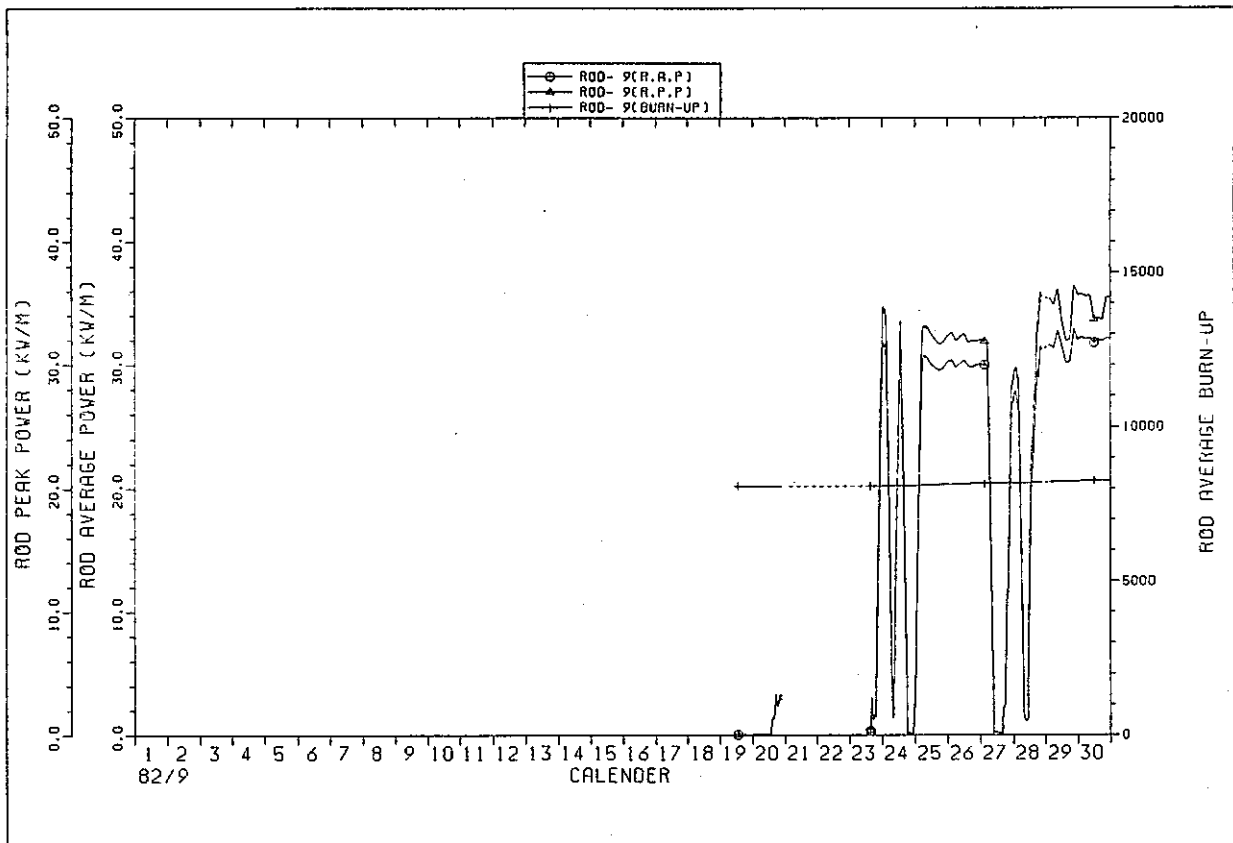

IFA529 ROD POWER HISTORY

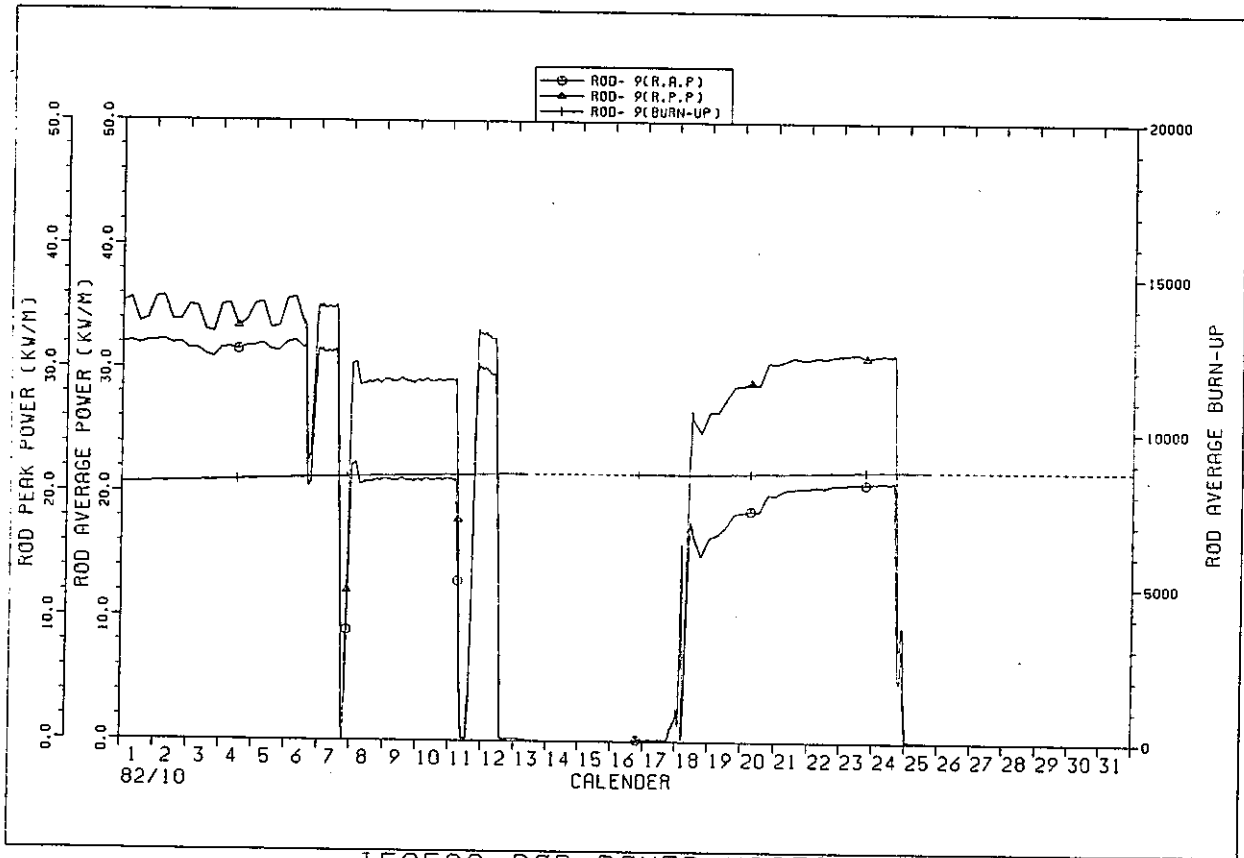

IFA529 ROD POWER HISTORY

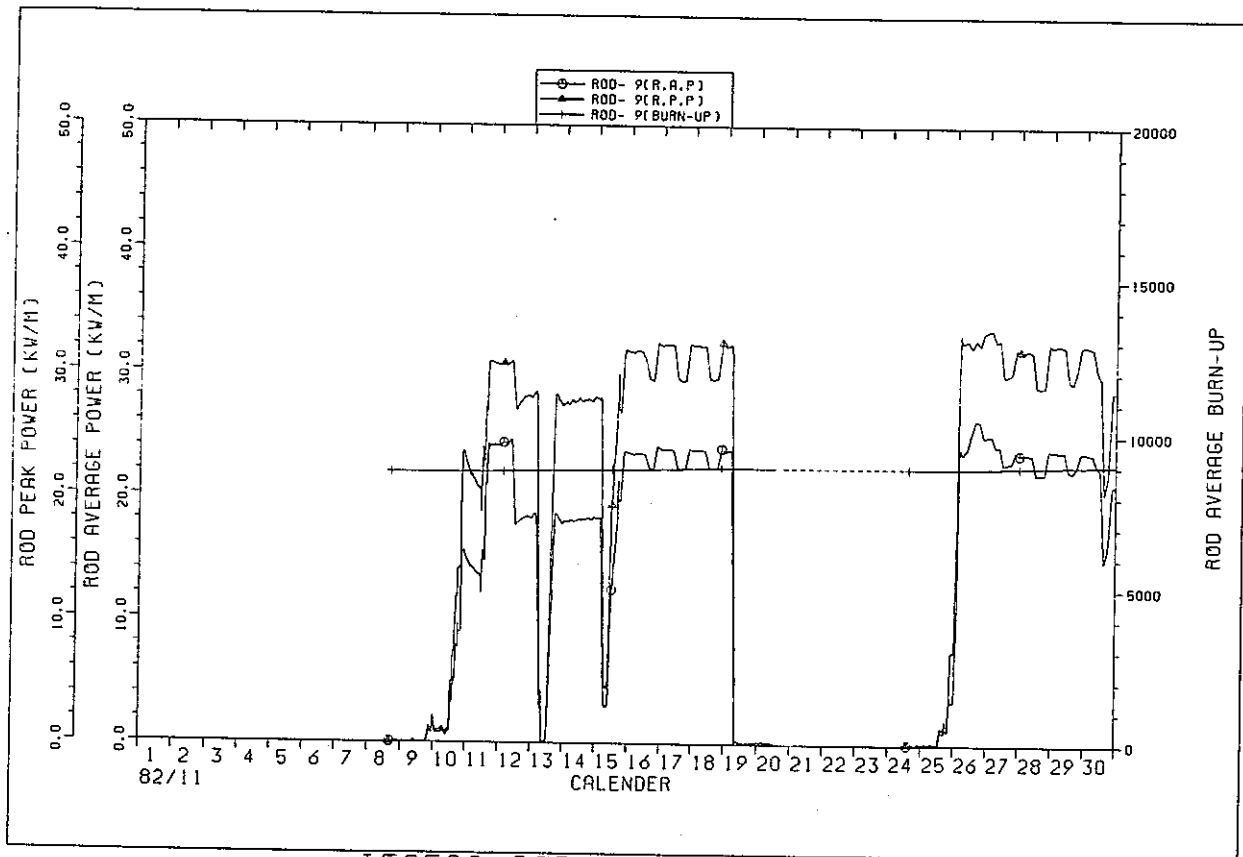

IFA529 ROD POWER HISTORY

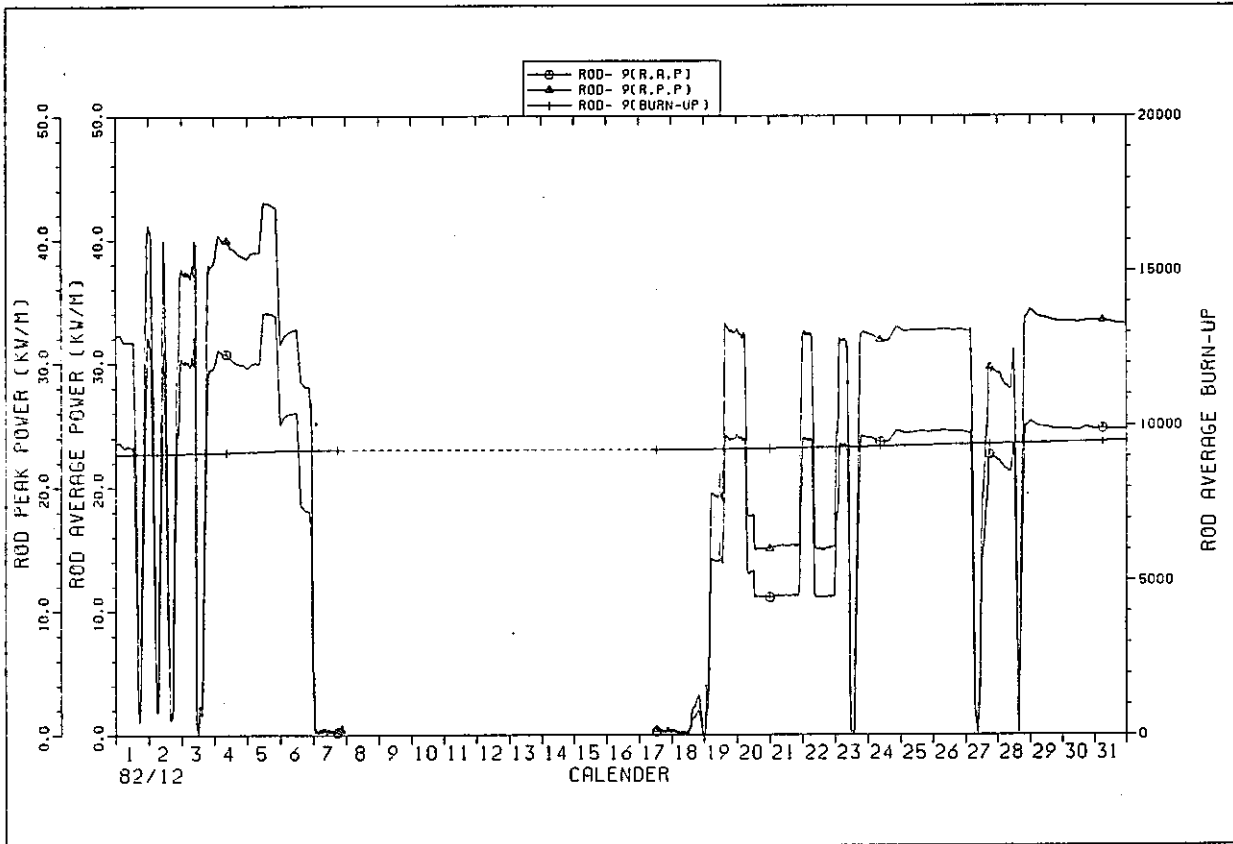

IFA529 ROD POWER HISTORY

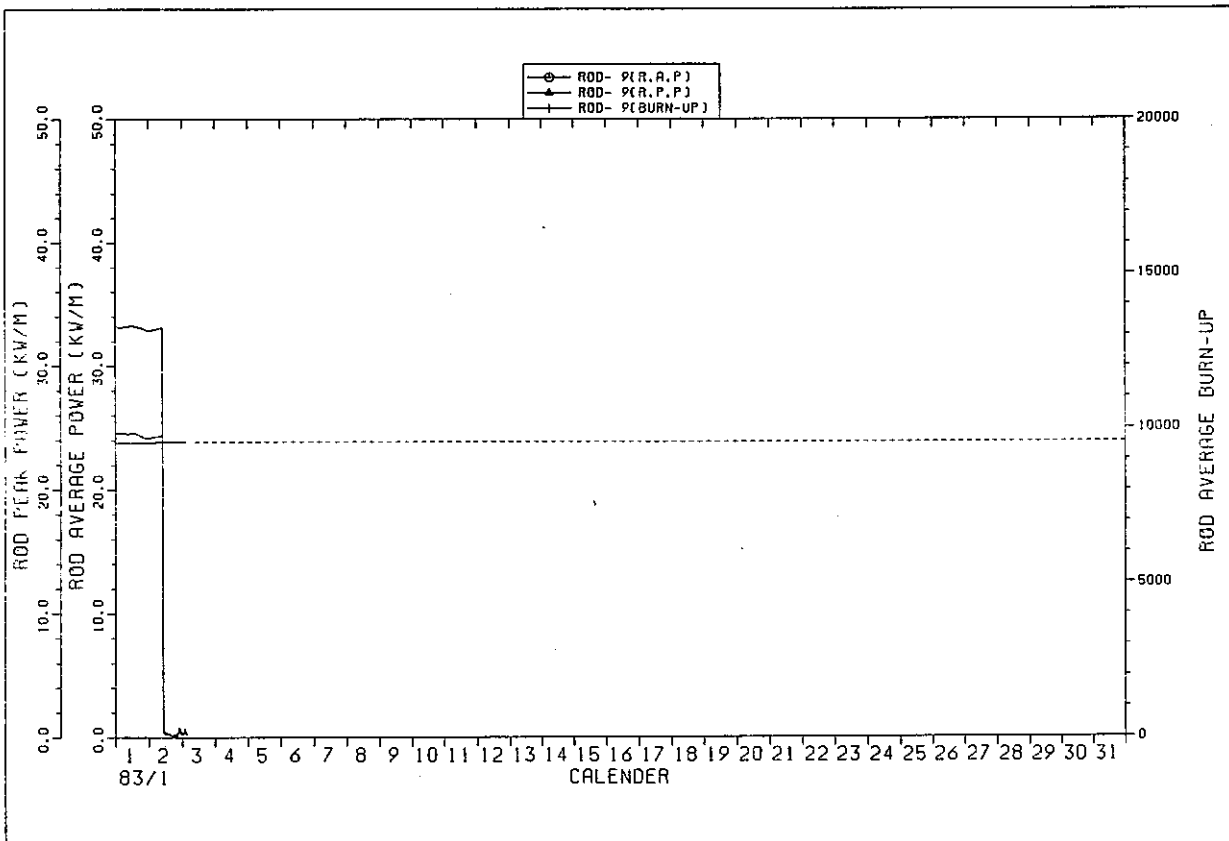

IFA529 ROD POWER HISTORY

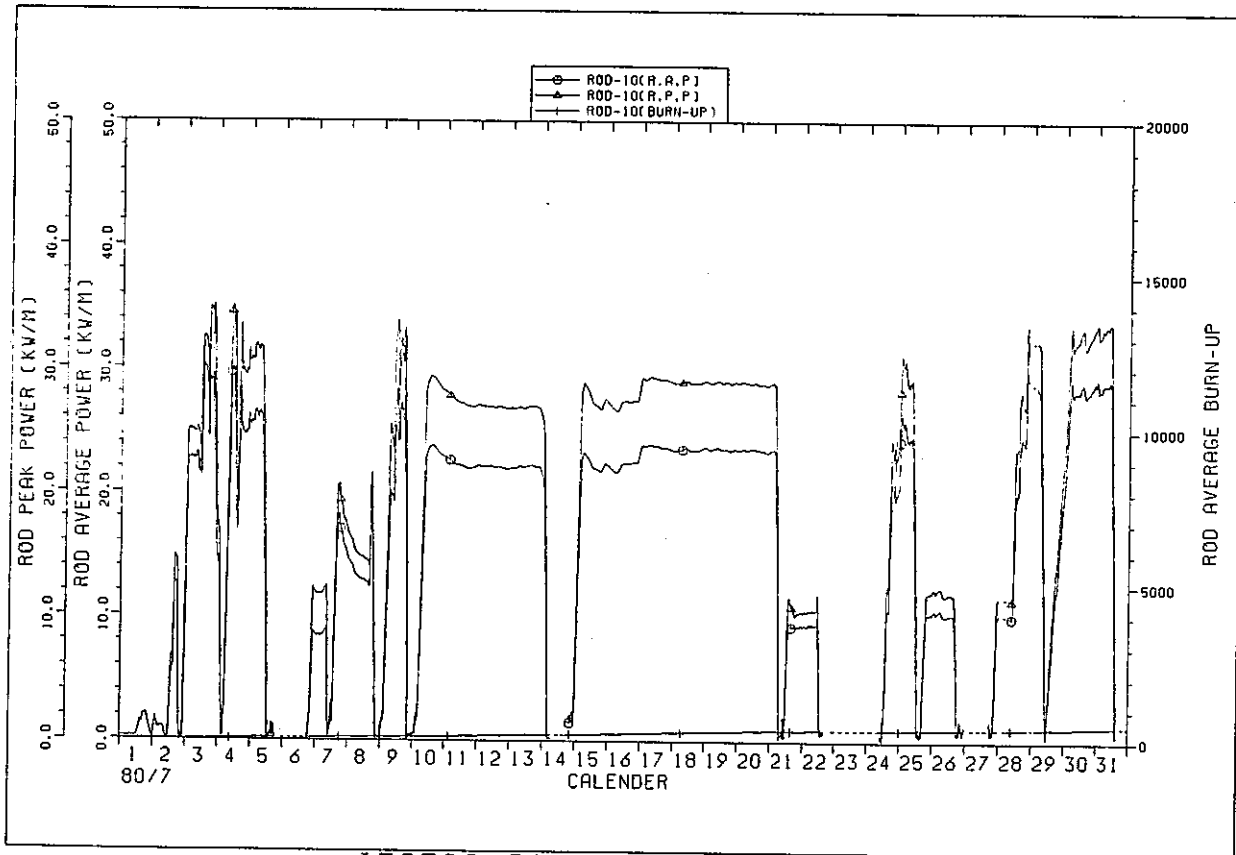

IFA529 ROD POWER HISTORY

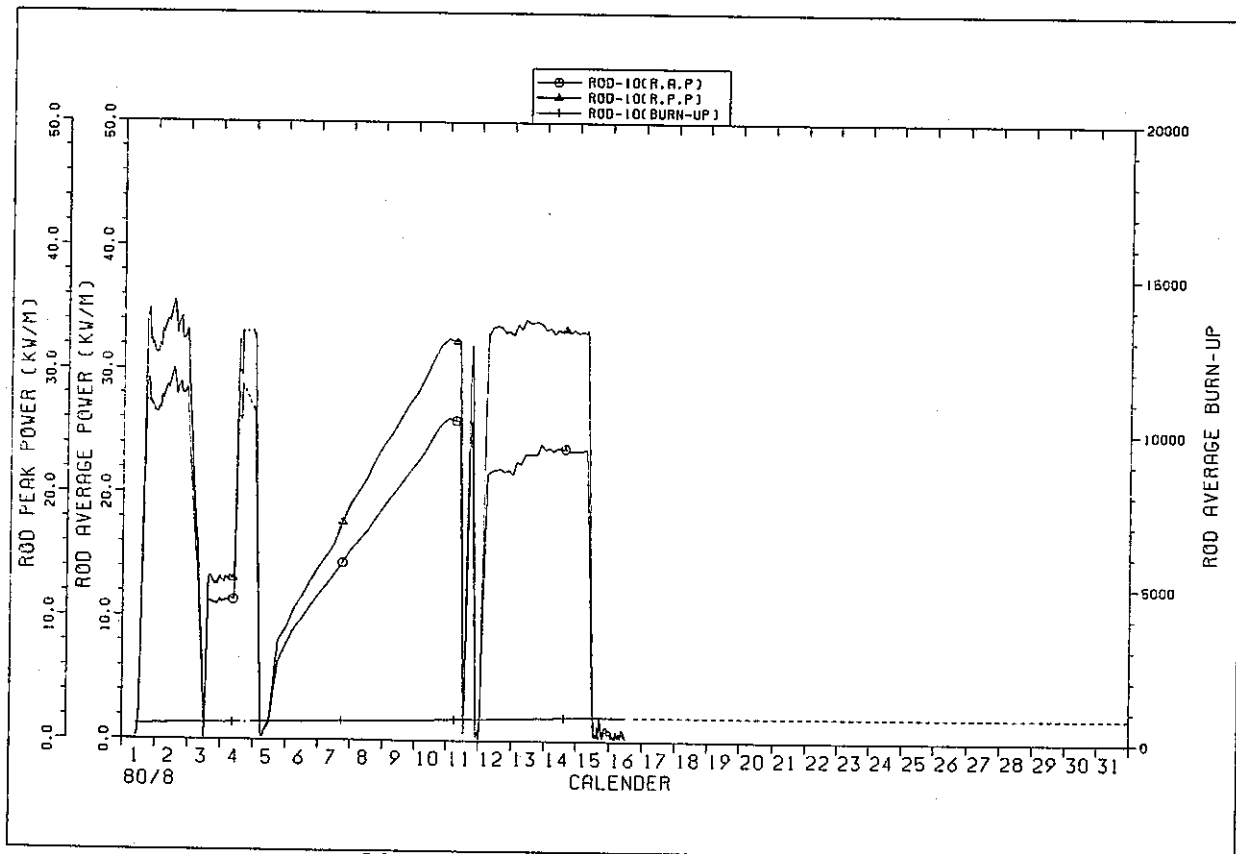

IFA529 ROD POWER HISTORY

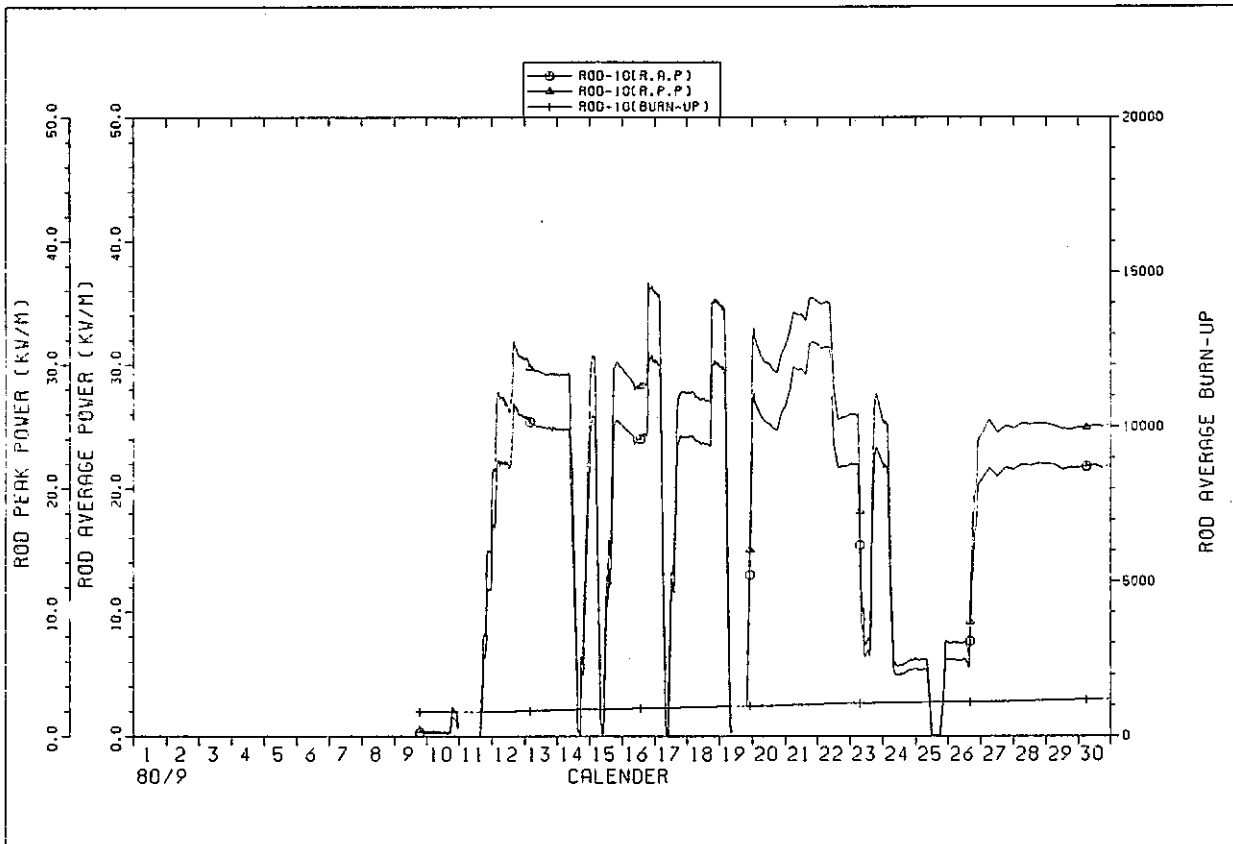

IFA529 ROD POWER HISTORY

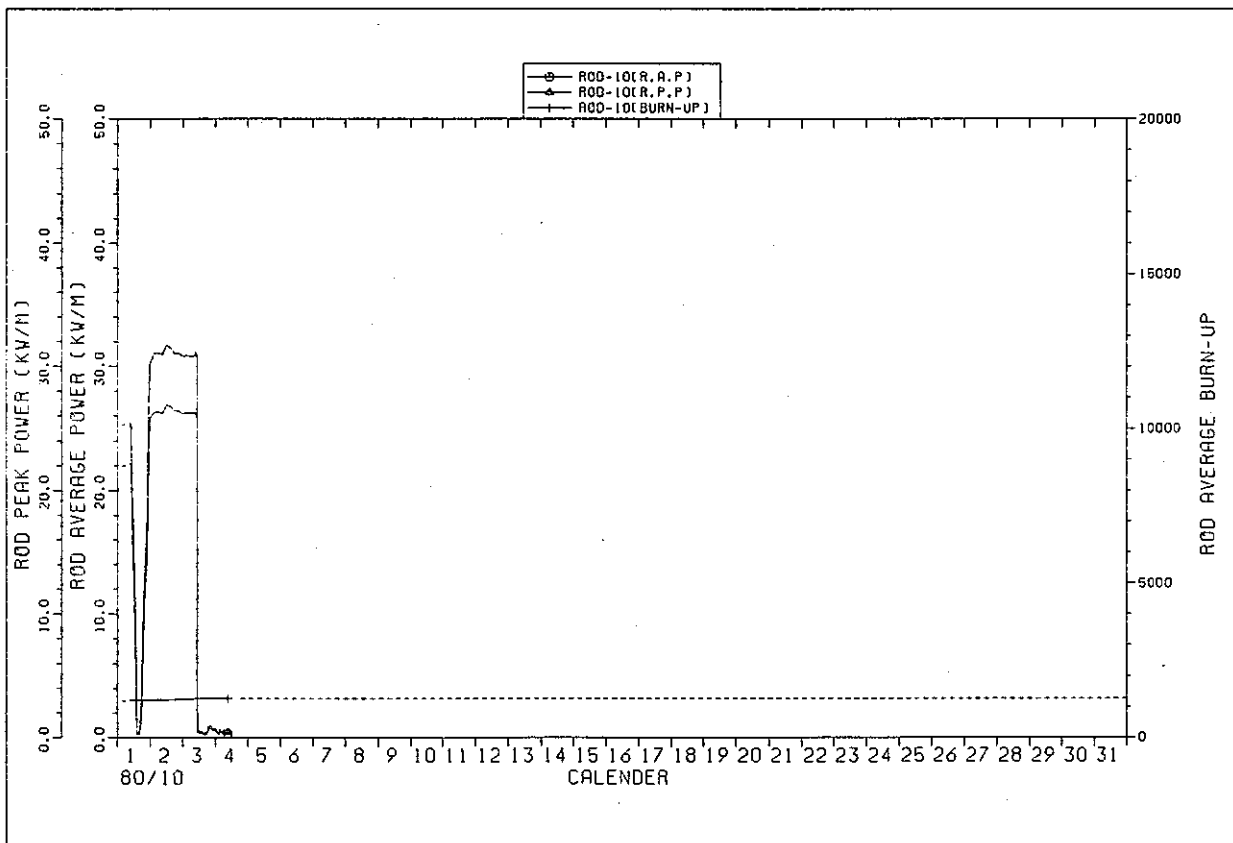

IFA529 ROD POWER HISTORY

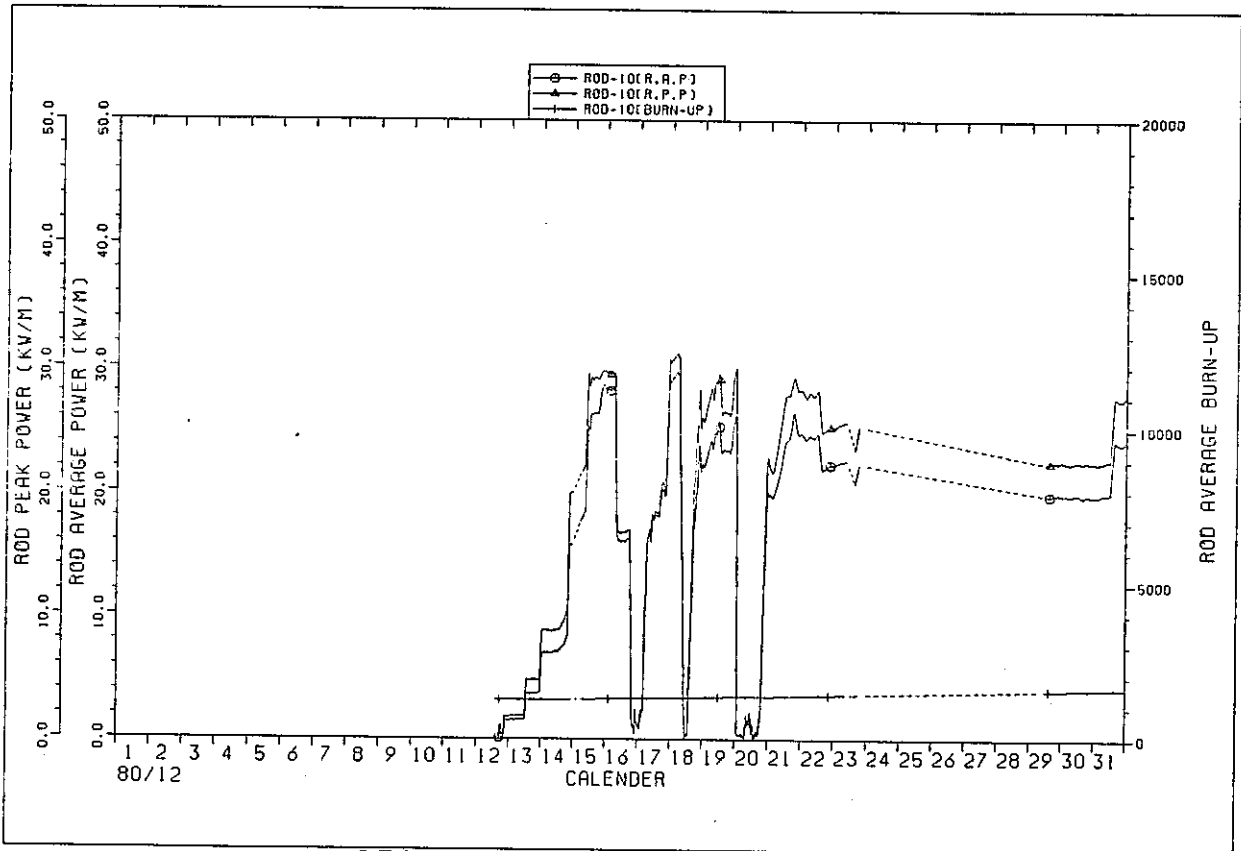

IFA529 ROD POWER HISTORY

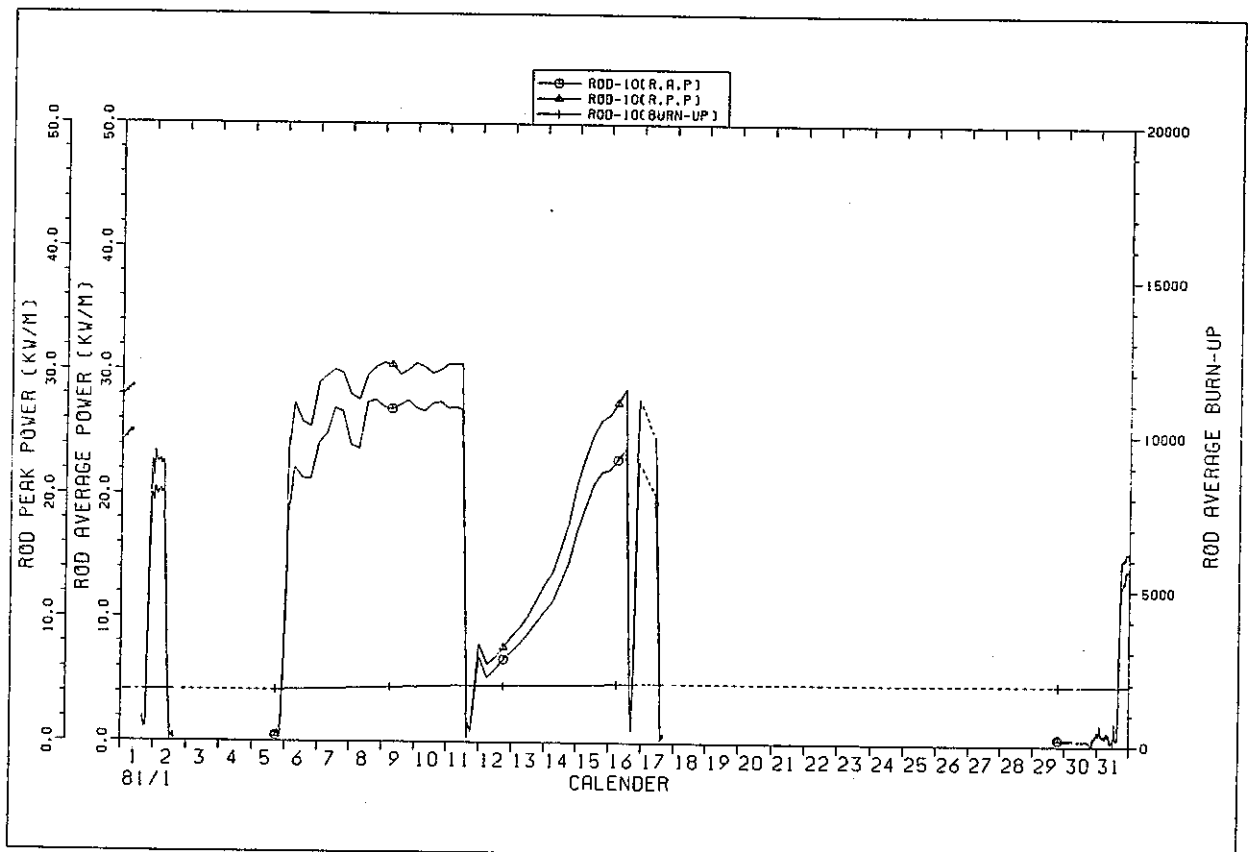

IFA529 ROD POWER HISTORY

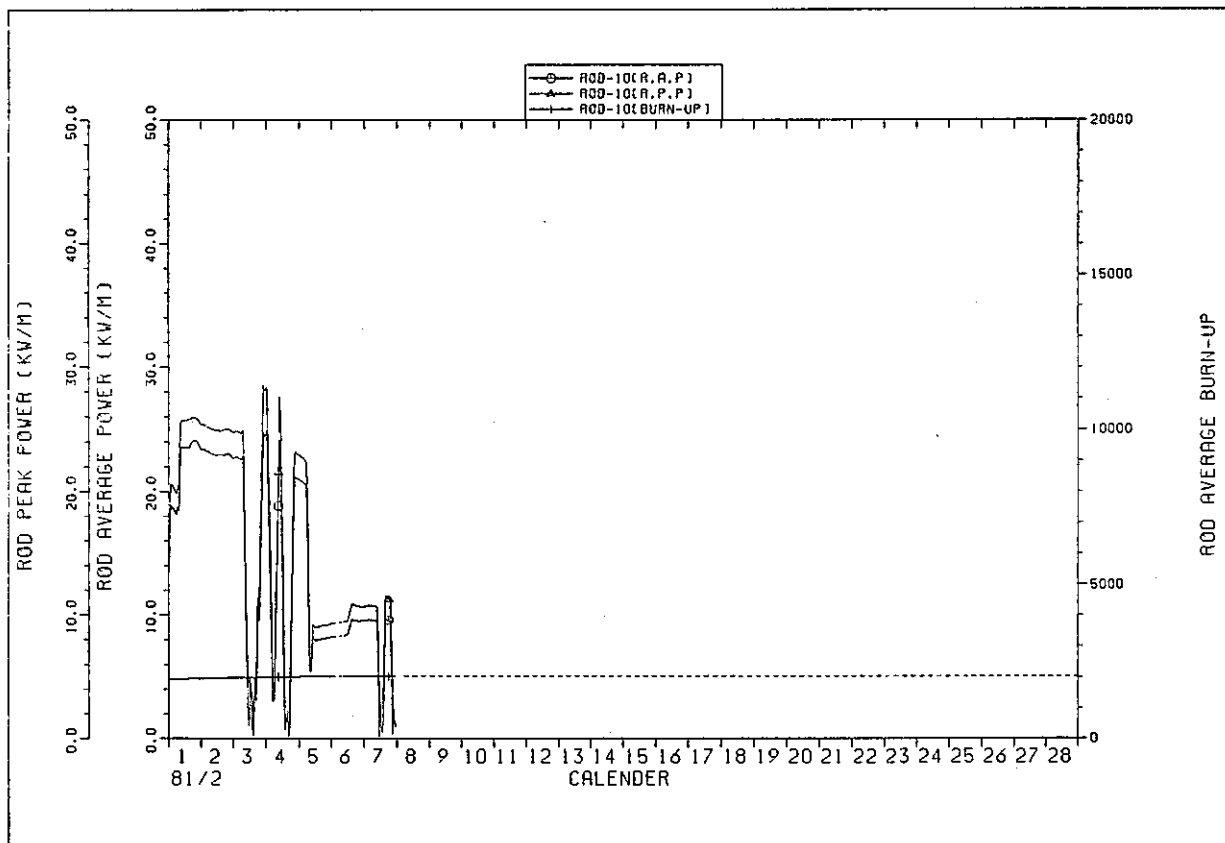

IFA529 ROD POWER HISTORY

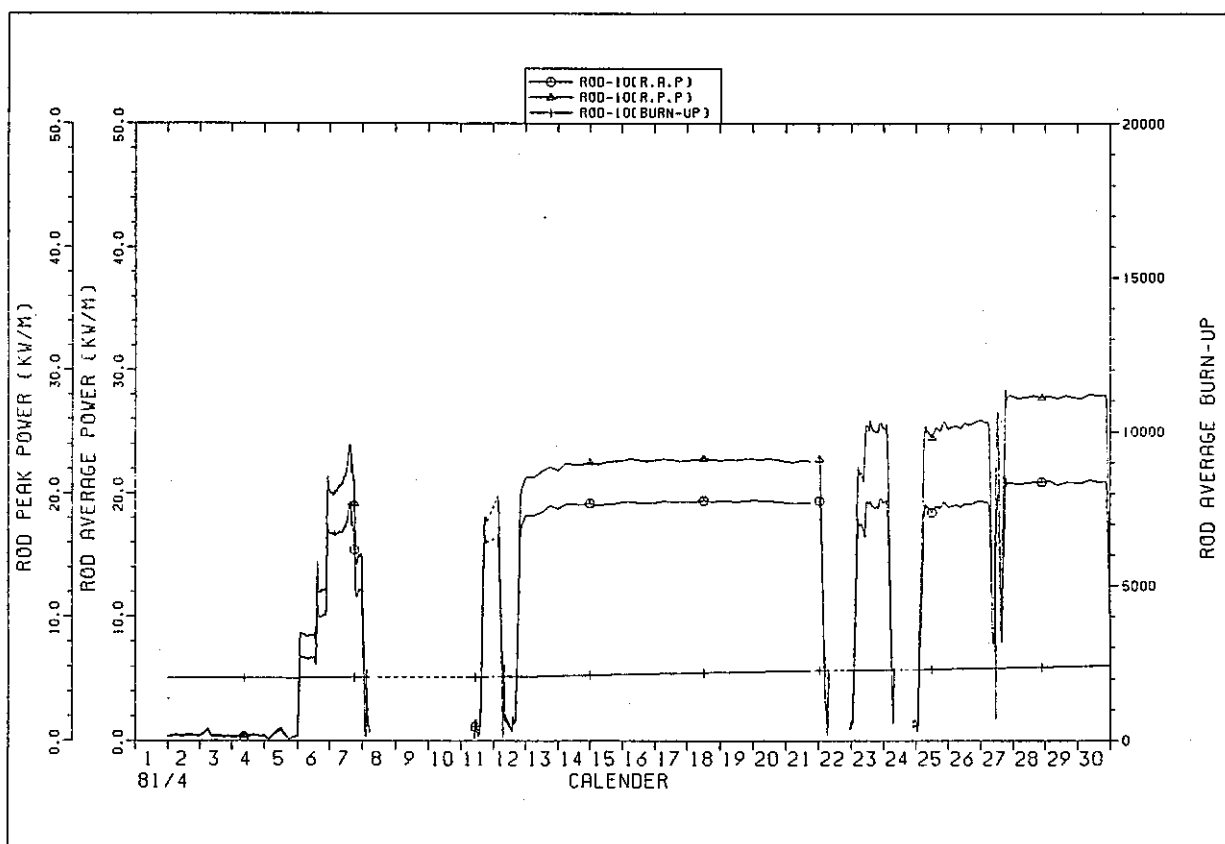

IFA529 ROD POWER HISTORY

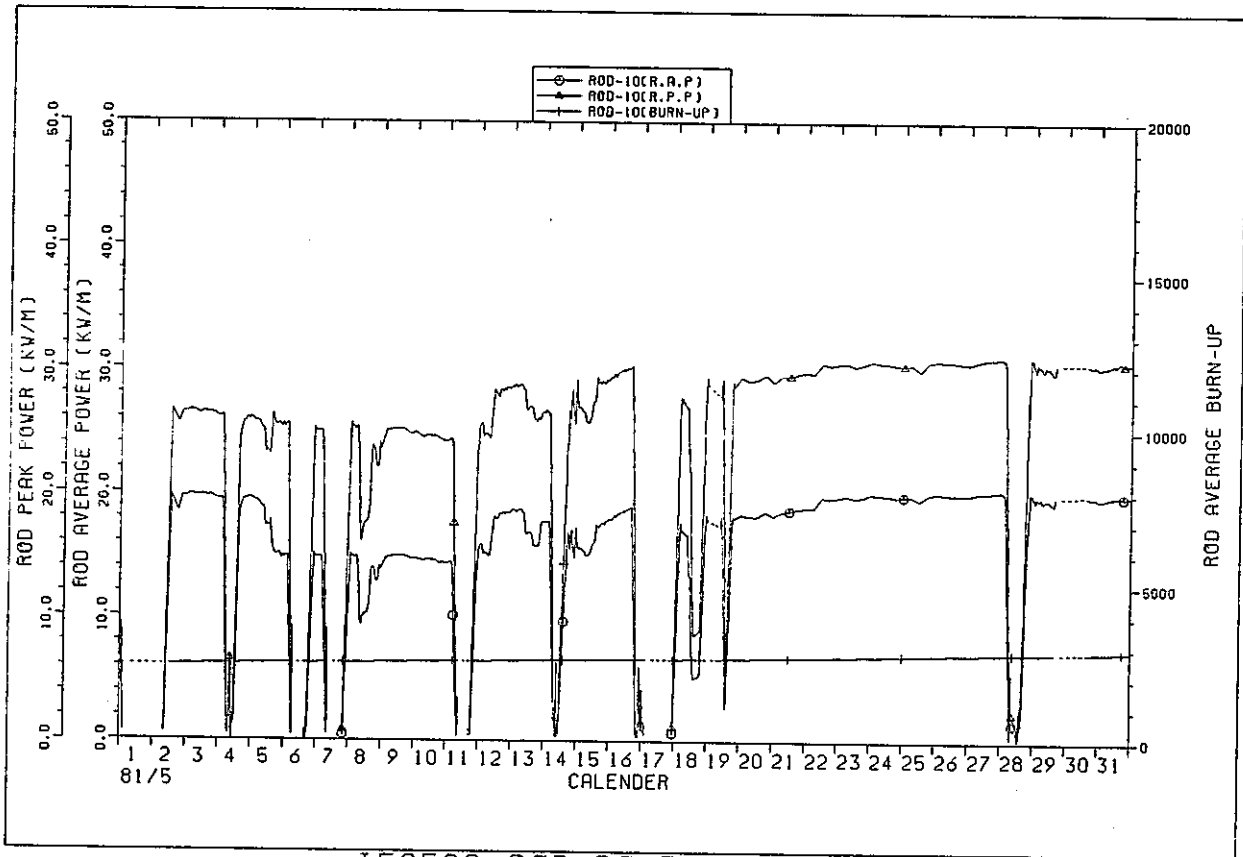

IFA529 ROD POWER HISTORY

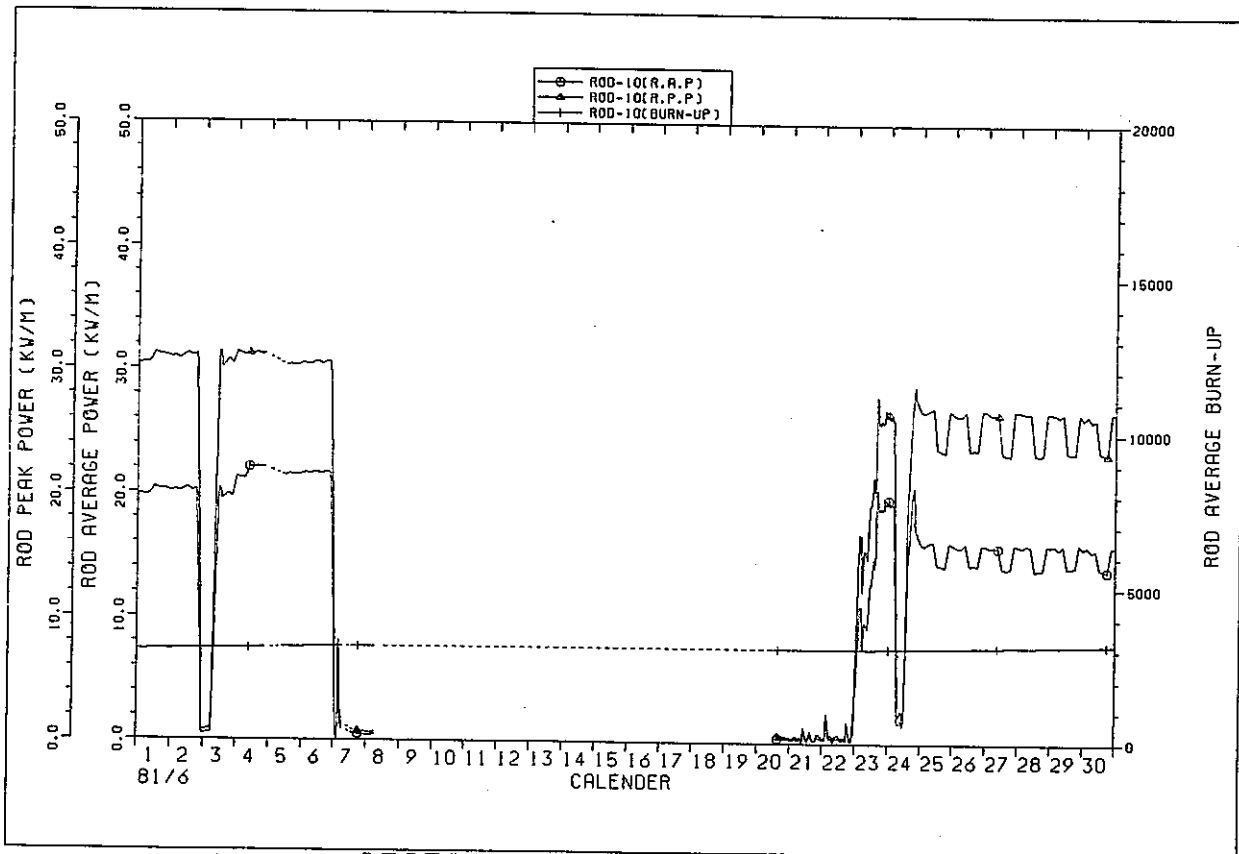

IFA529 ROD POWER HISTORY

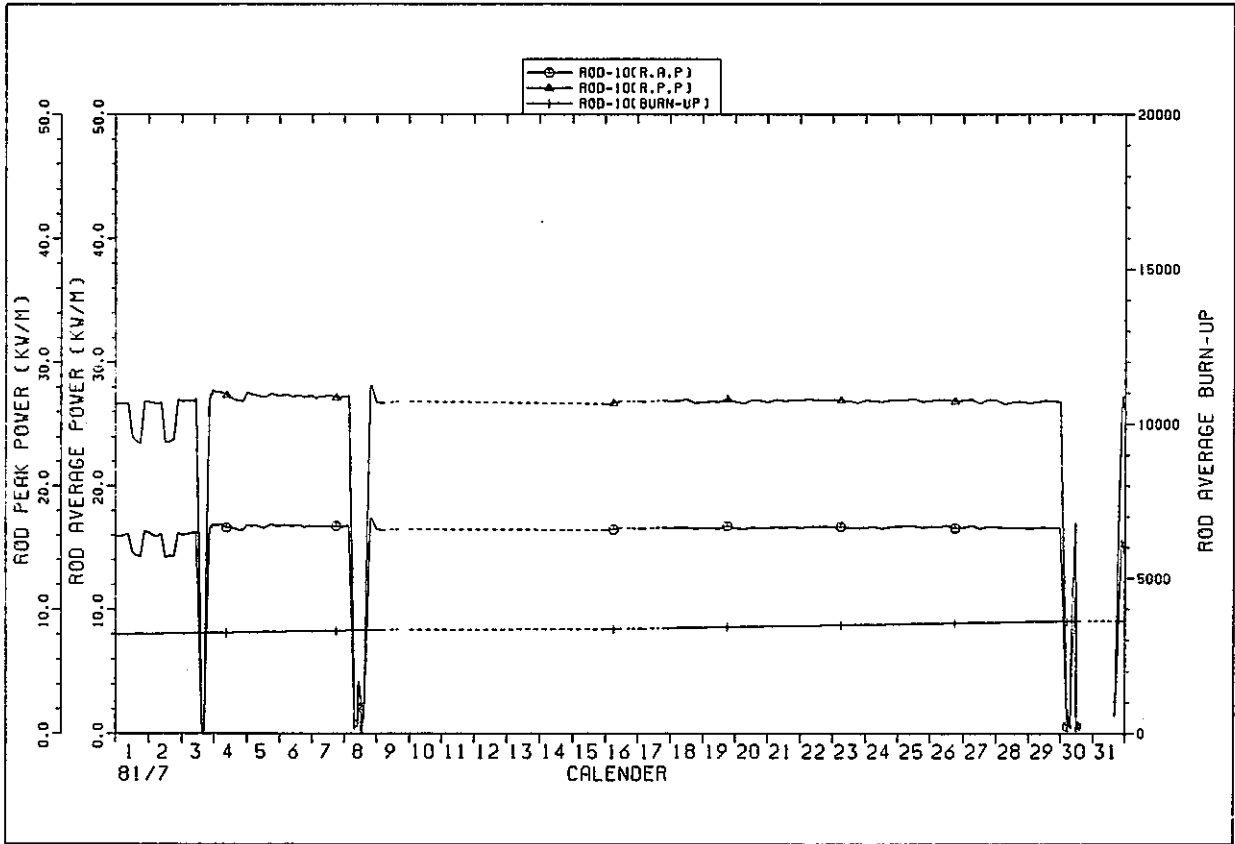

IFA529 ROD POWER HISTORY

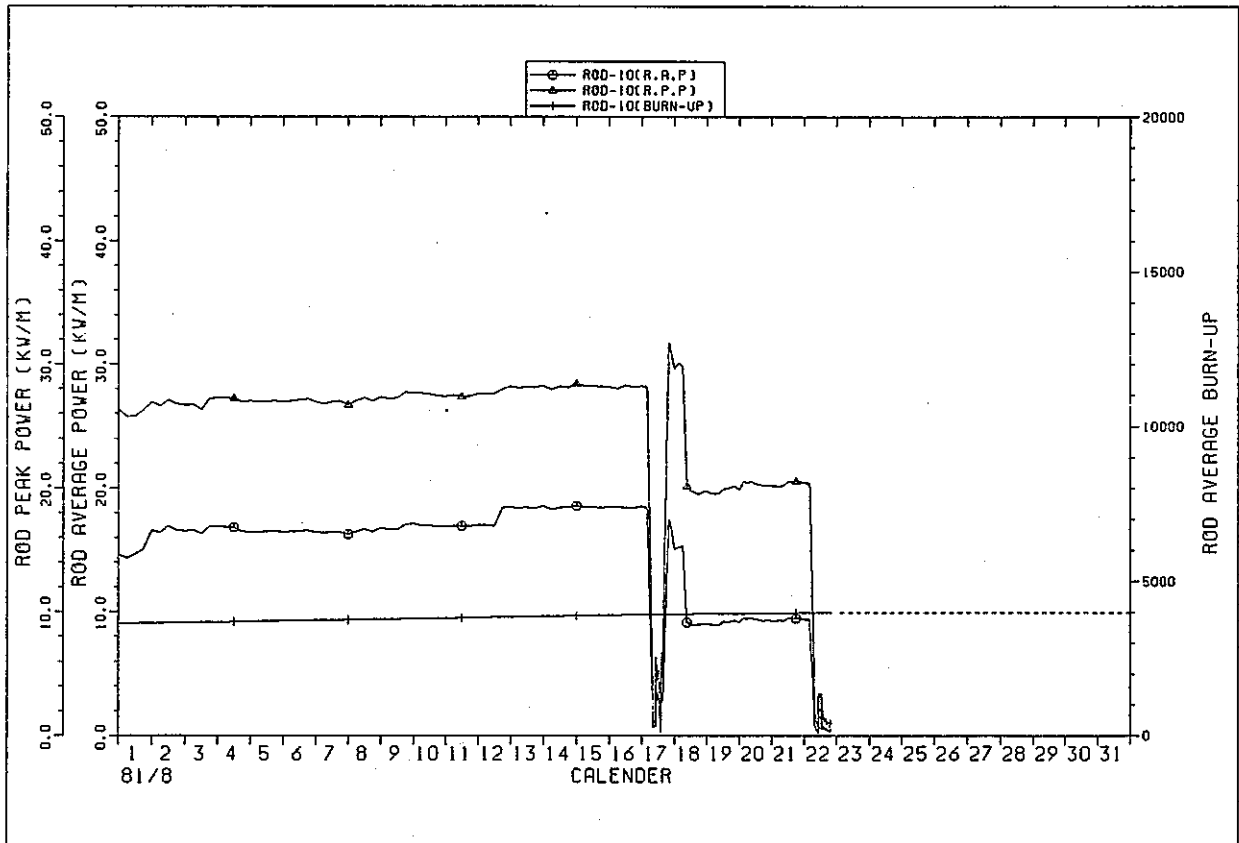

IFA529 ROD POWER HISTORY

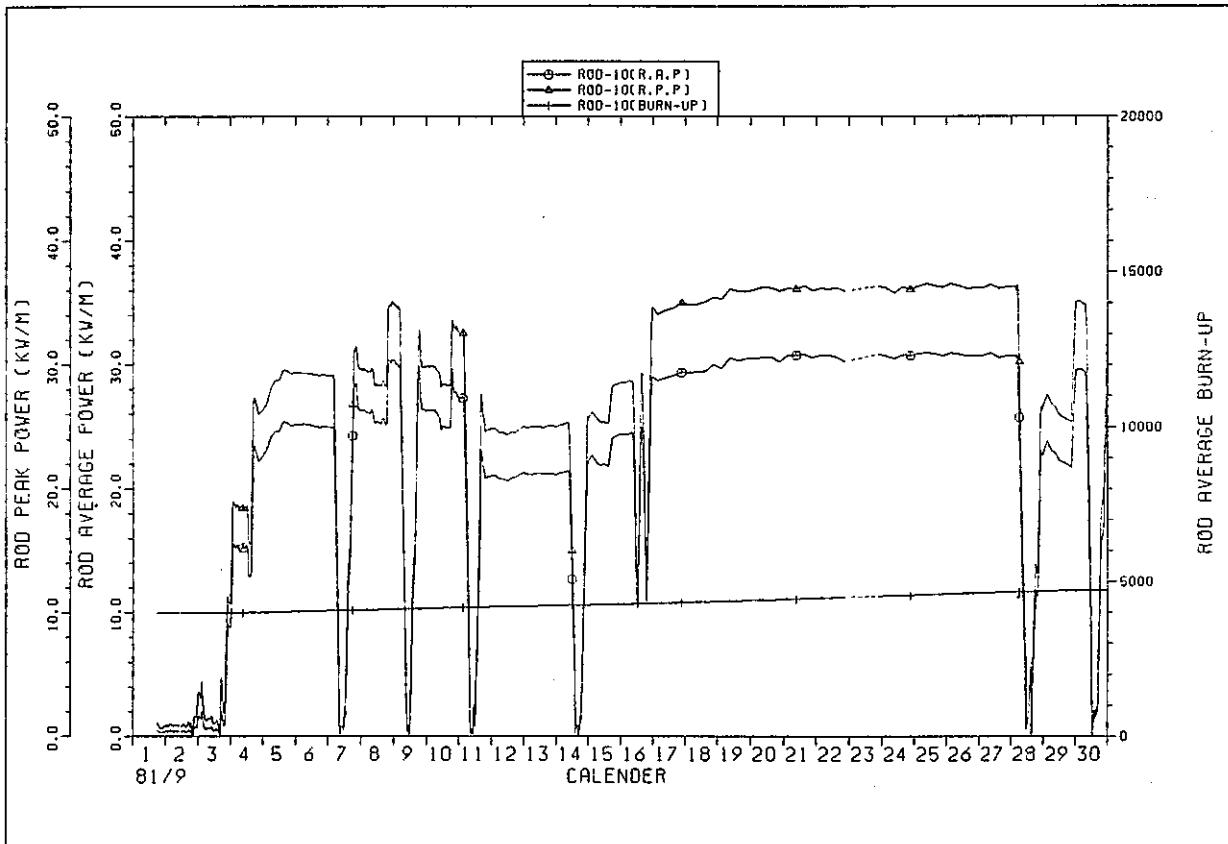

IFA529 ROD POWER HISTORY

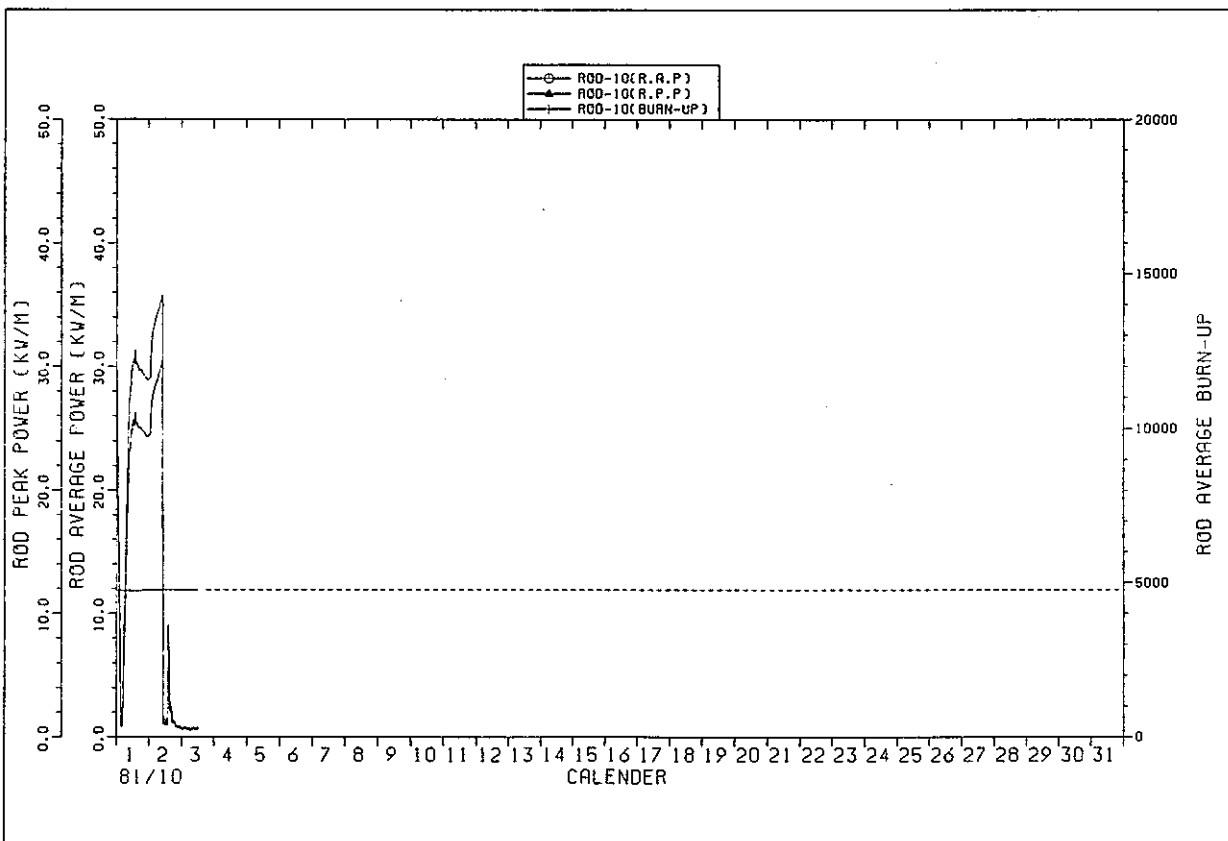

IFA529 ROD POWER HISTORY

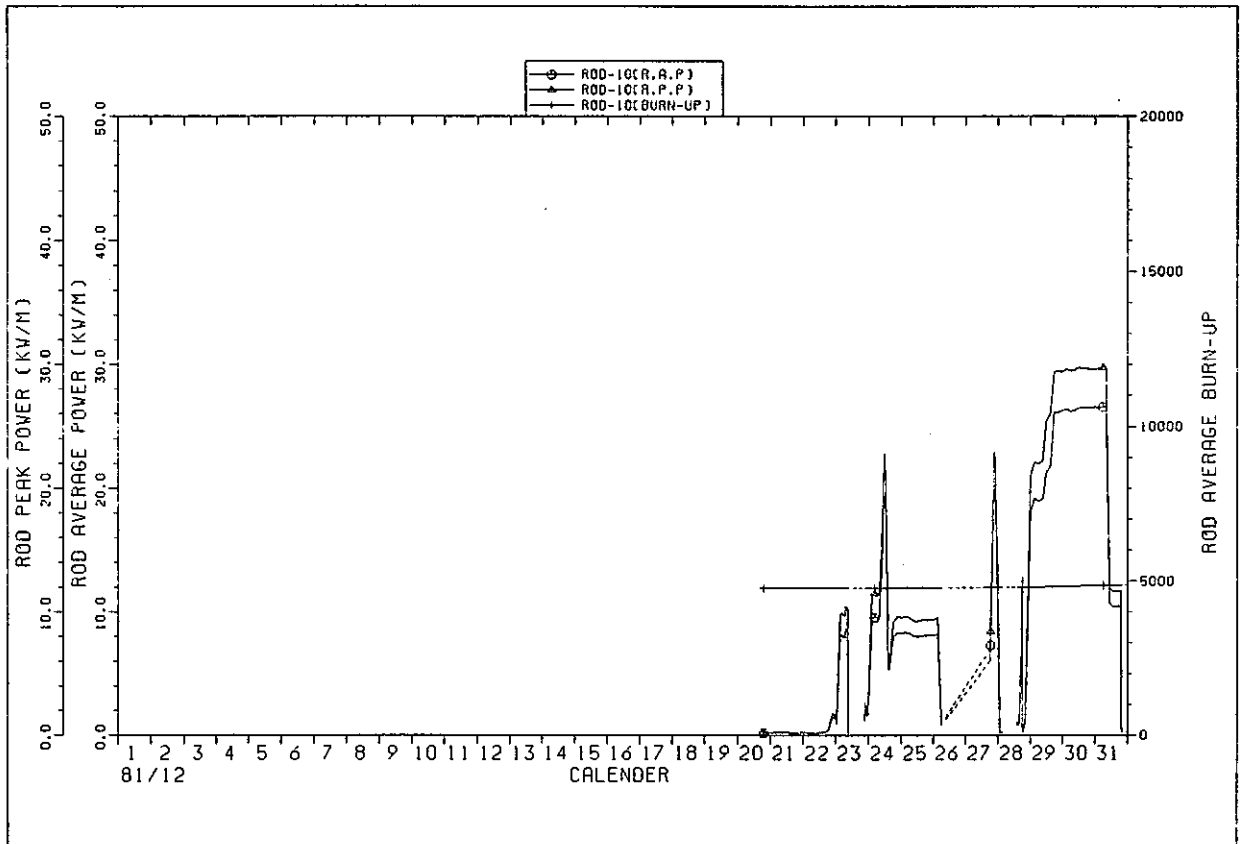

IFA529 ROD POWER HISTORY

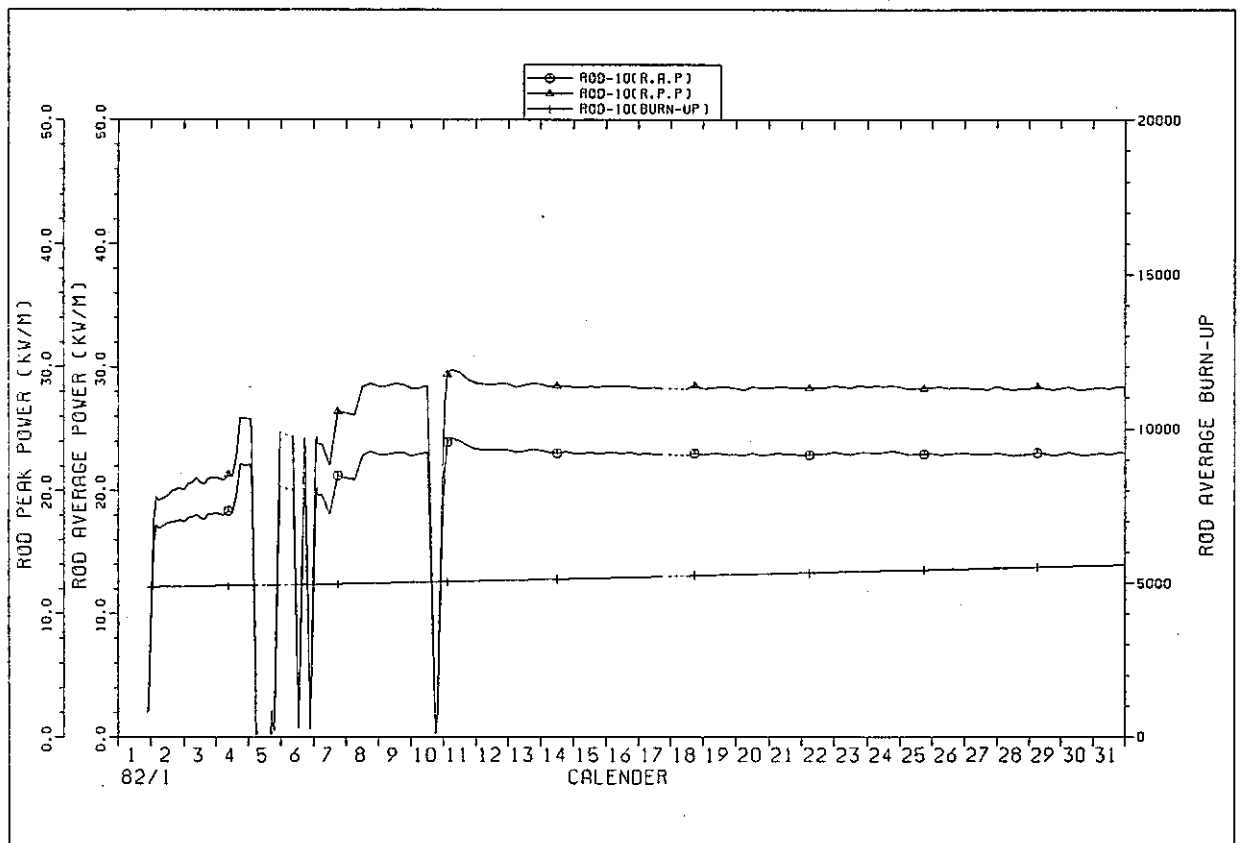

IFA529 ROD POWER HISTORY

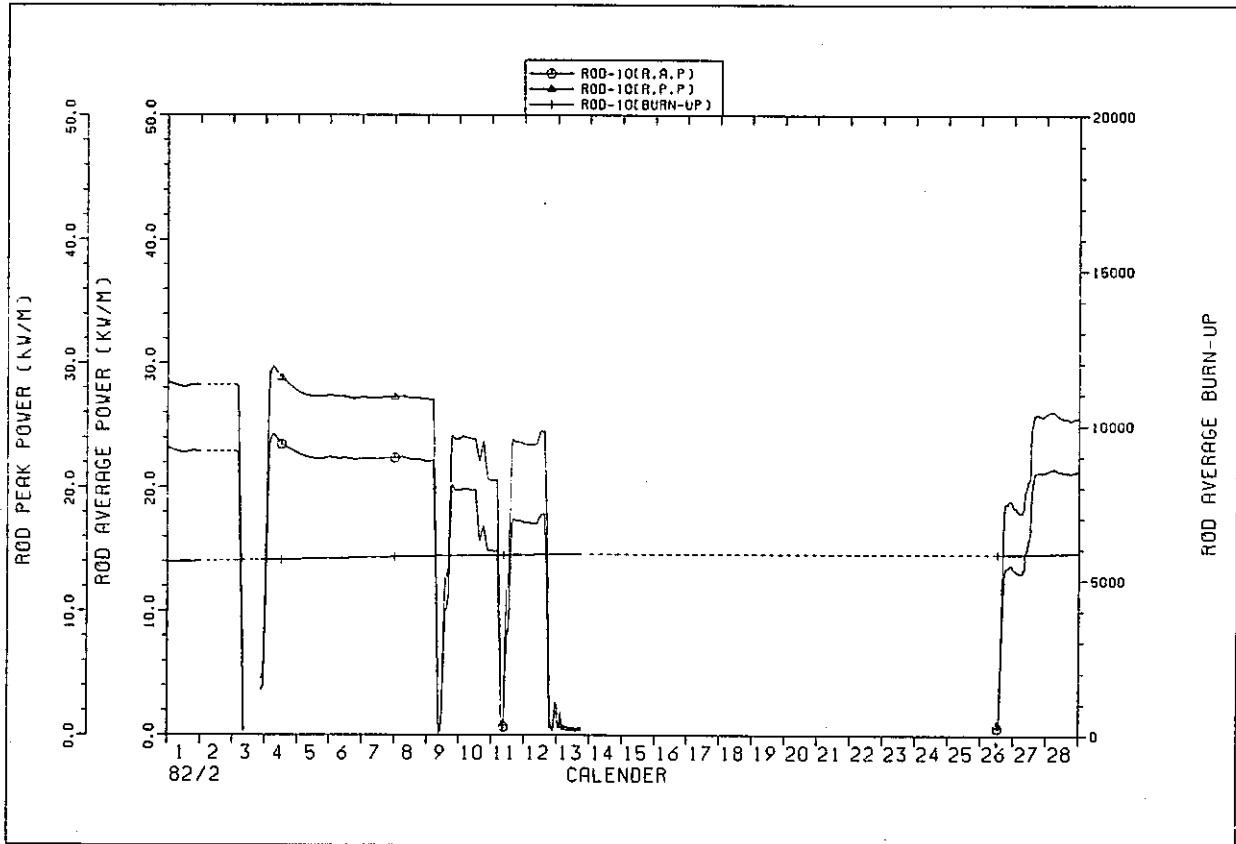

IFA529 ROD POWER HISTORY

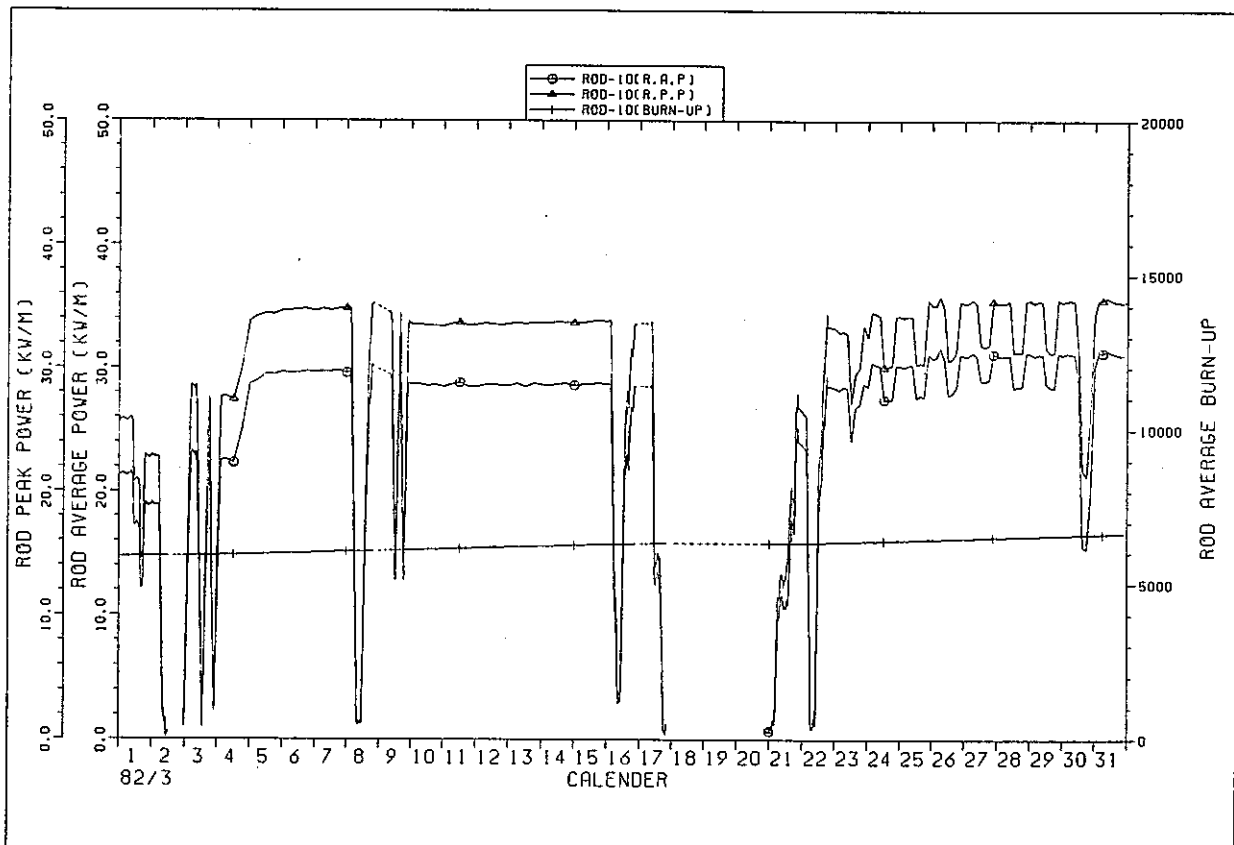

IFA529 ROD POWER HISTORY

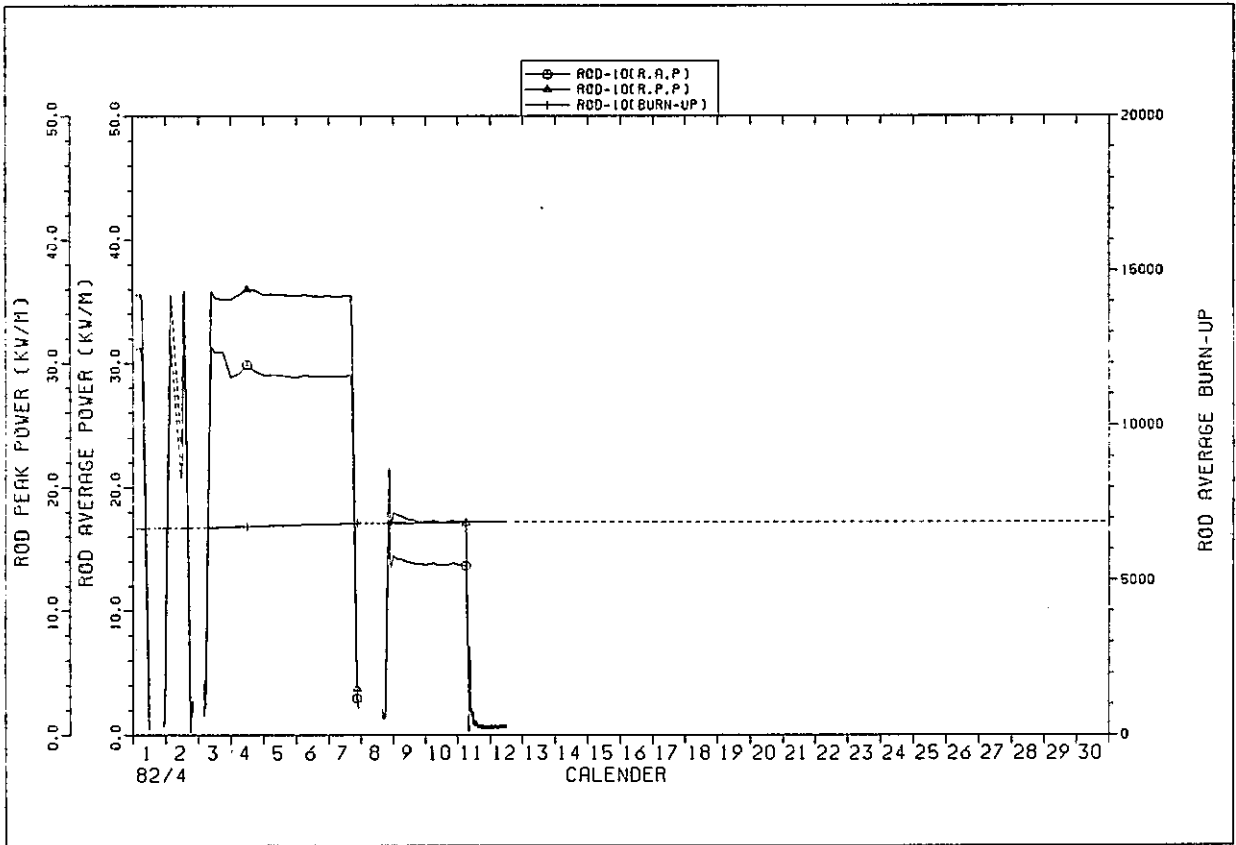

IFA529 ROD POWER HISTORY

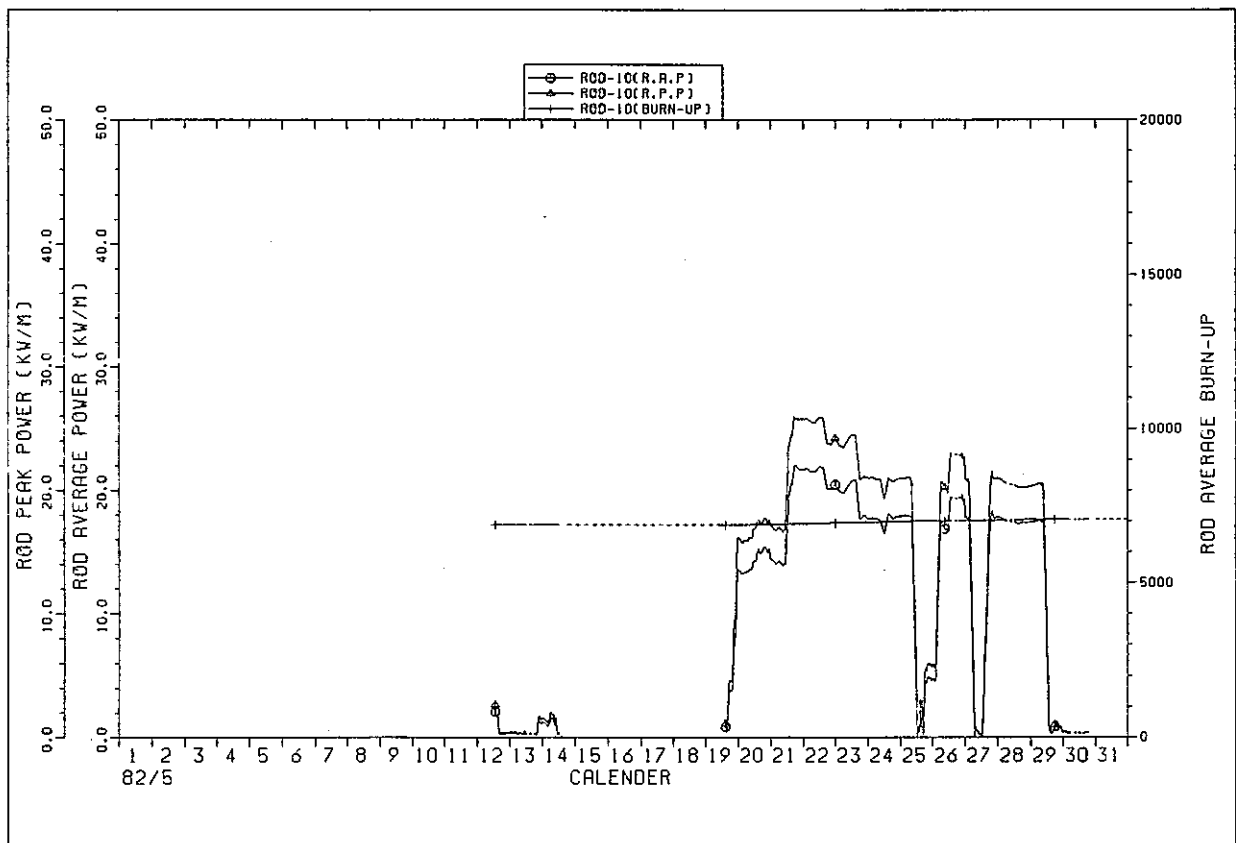

IFA529 ROD POWER HISTORY

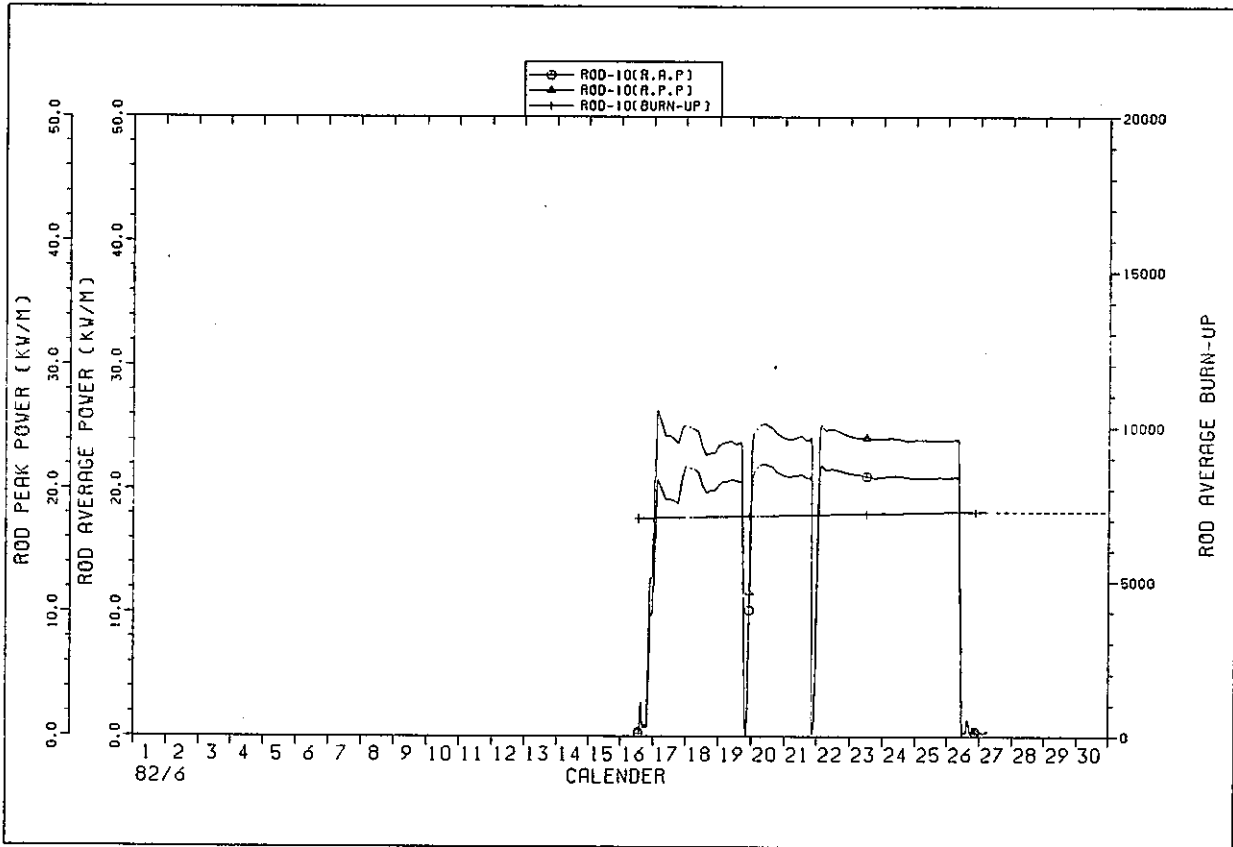

IFA529 ROD POWER HISTORY

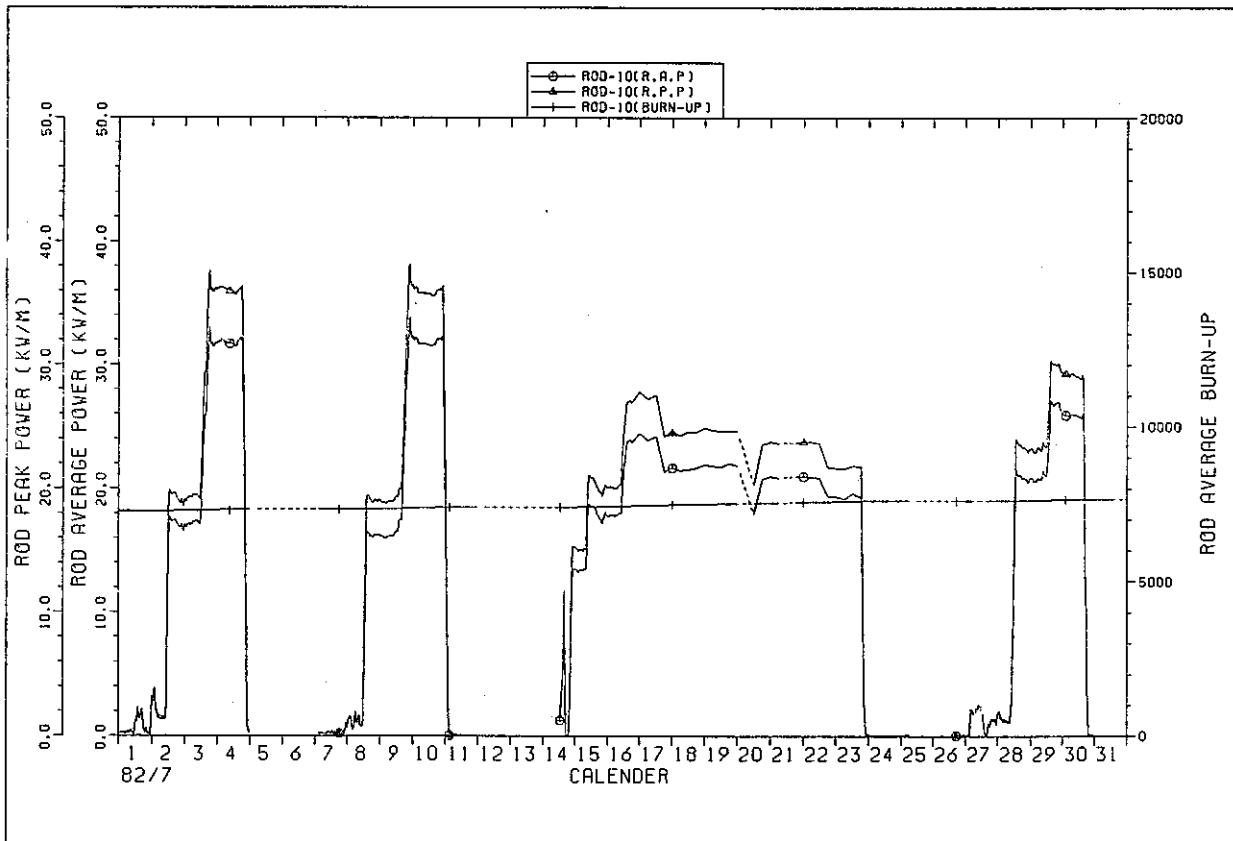

IFA529 ROD POWER HISTORY

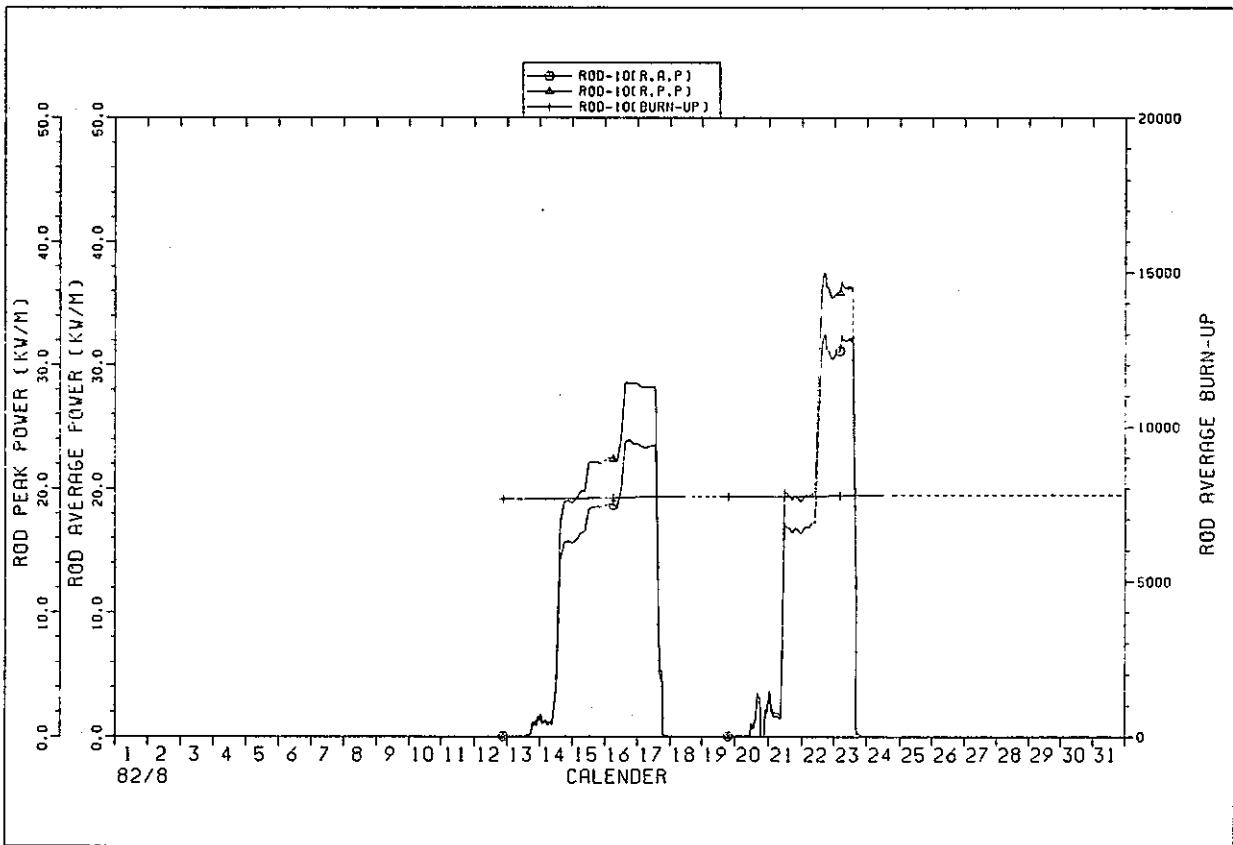

IFA529 ROD POWER HISTORY

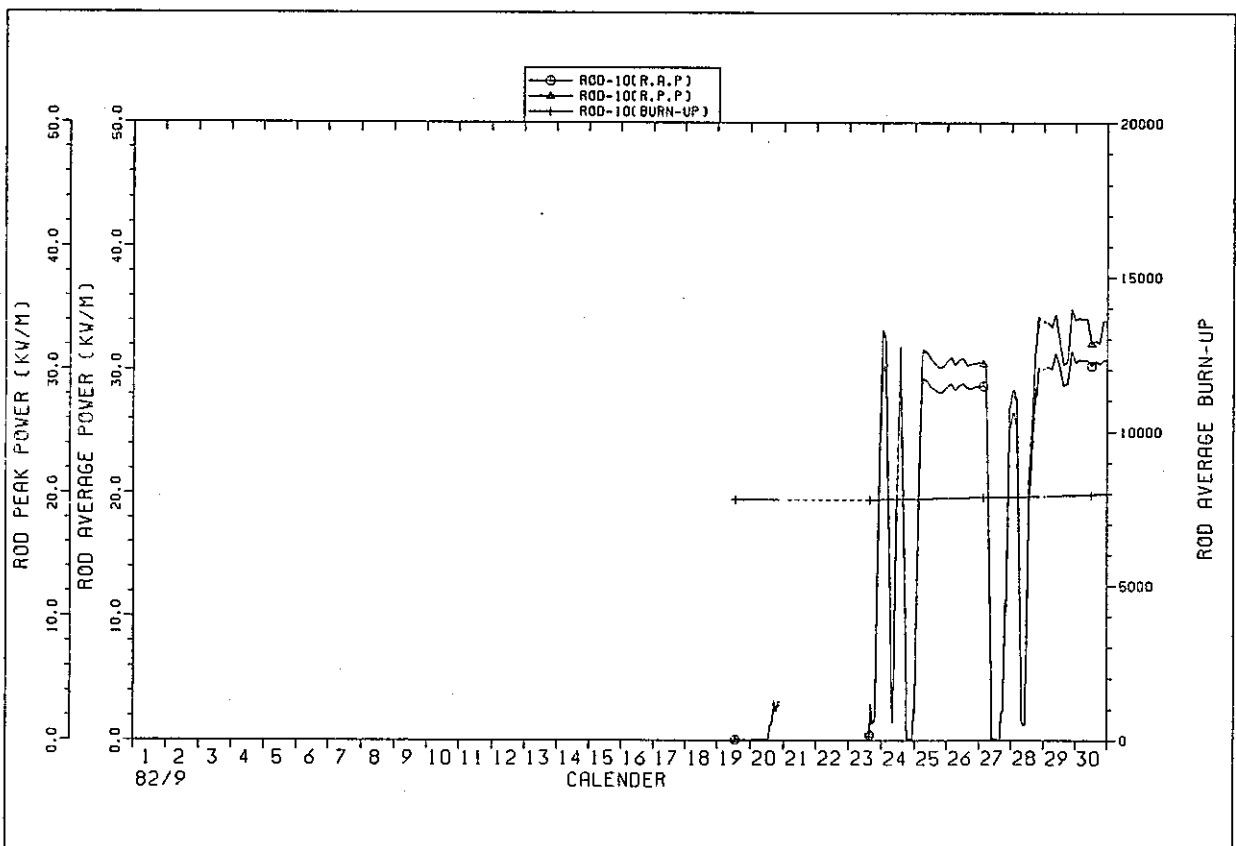

IFA529 ROD POWER HISTORY

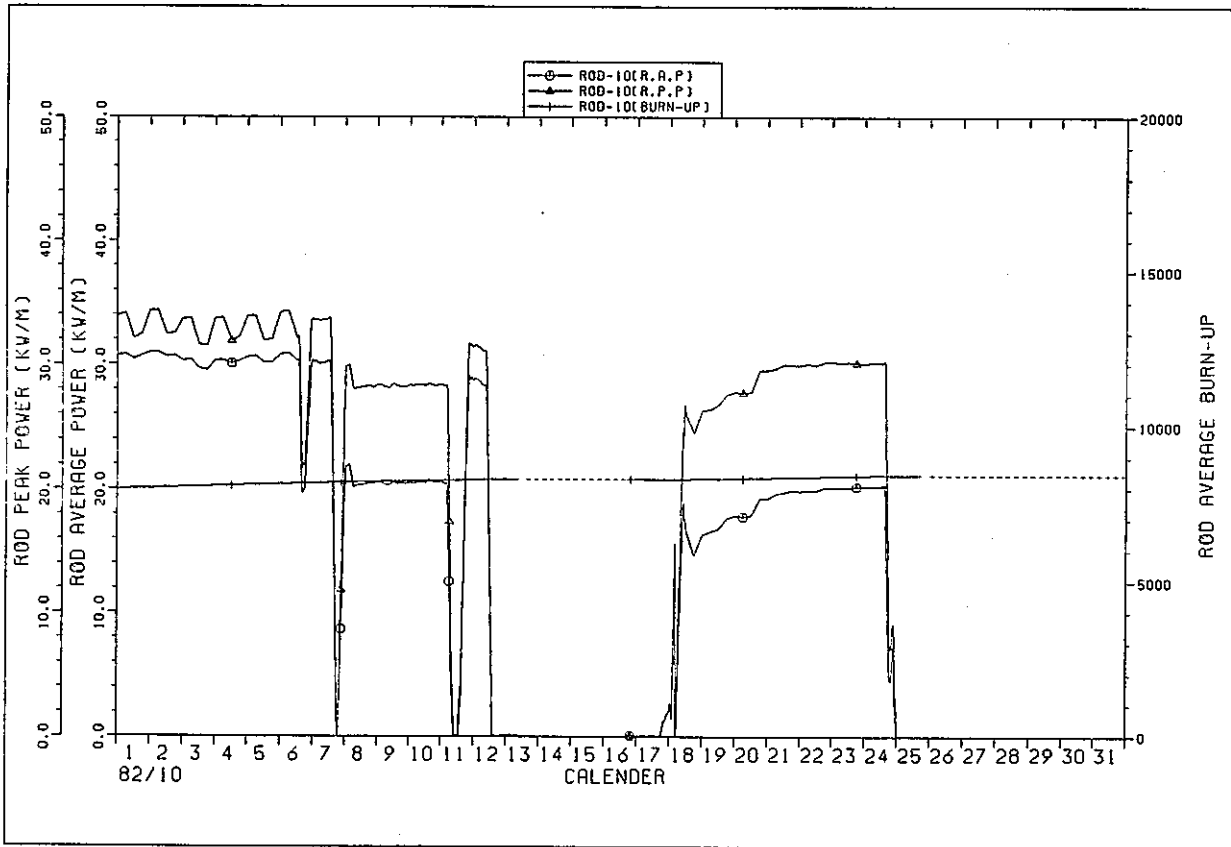

IFA529 ROD POWER HISTORY

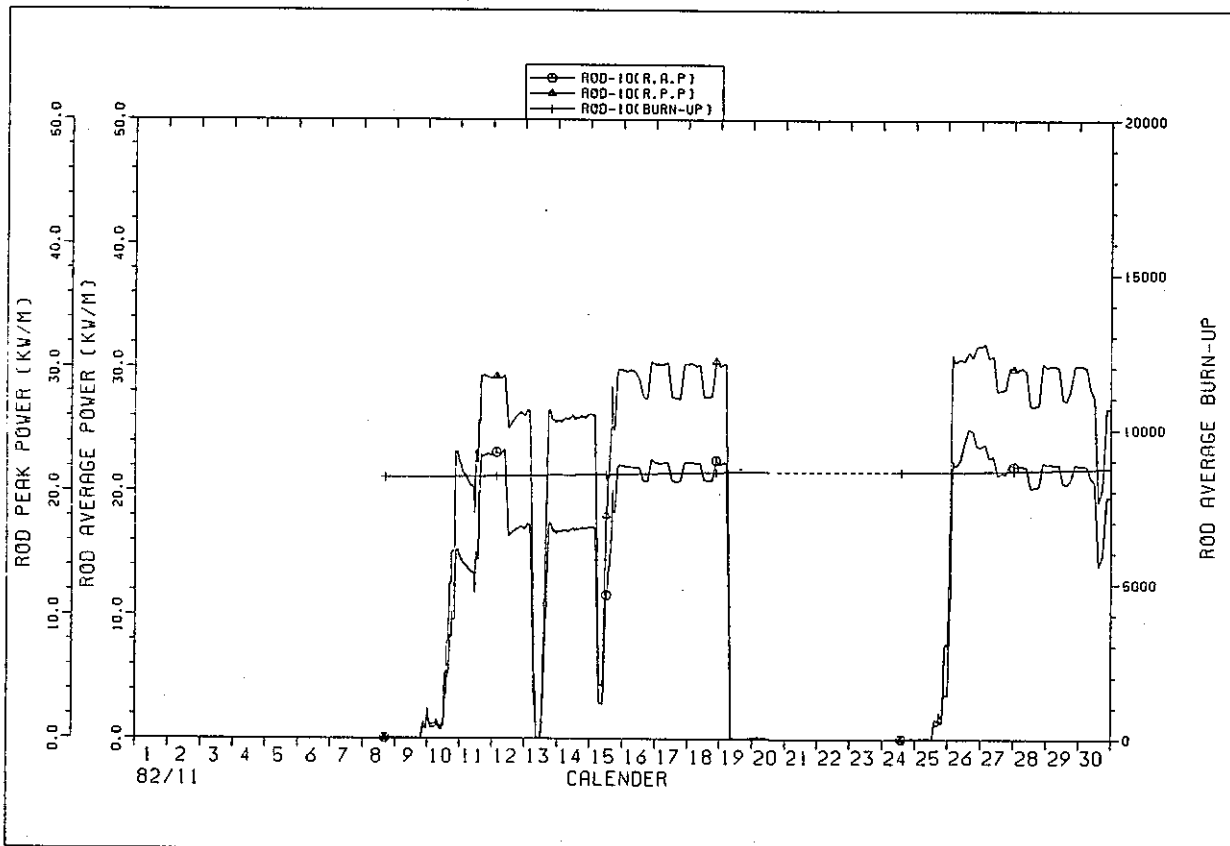

IFA529 ROD POWER HISTORY

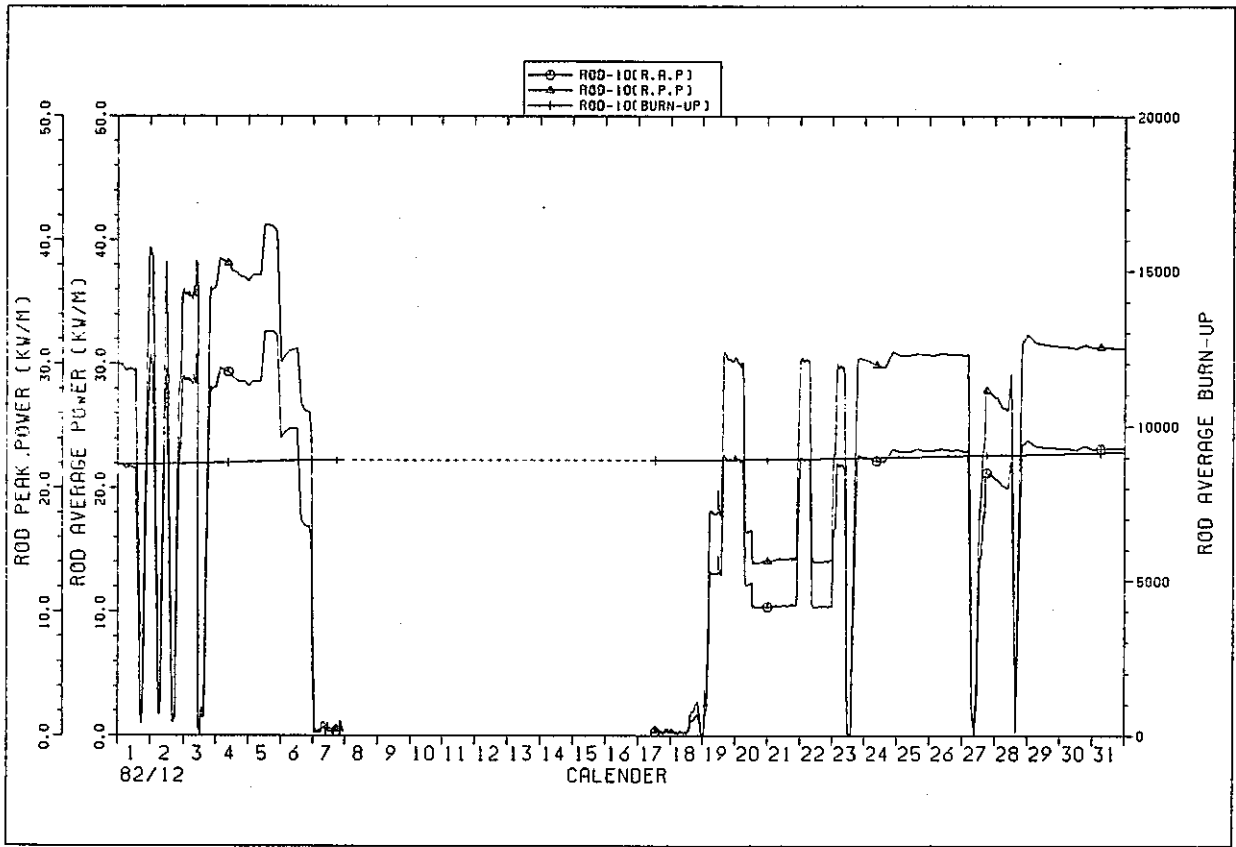

IFA529 ROD POWER HISTORY

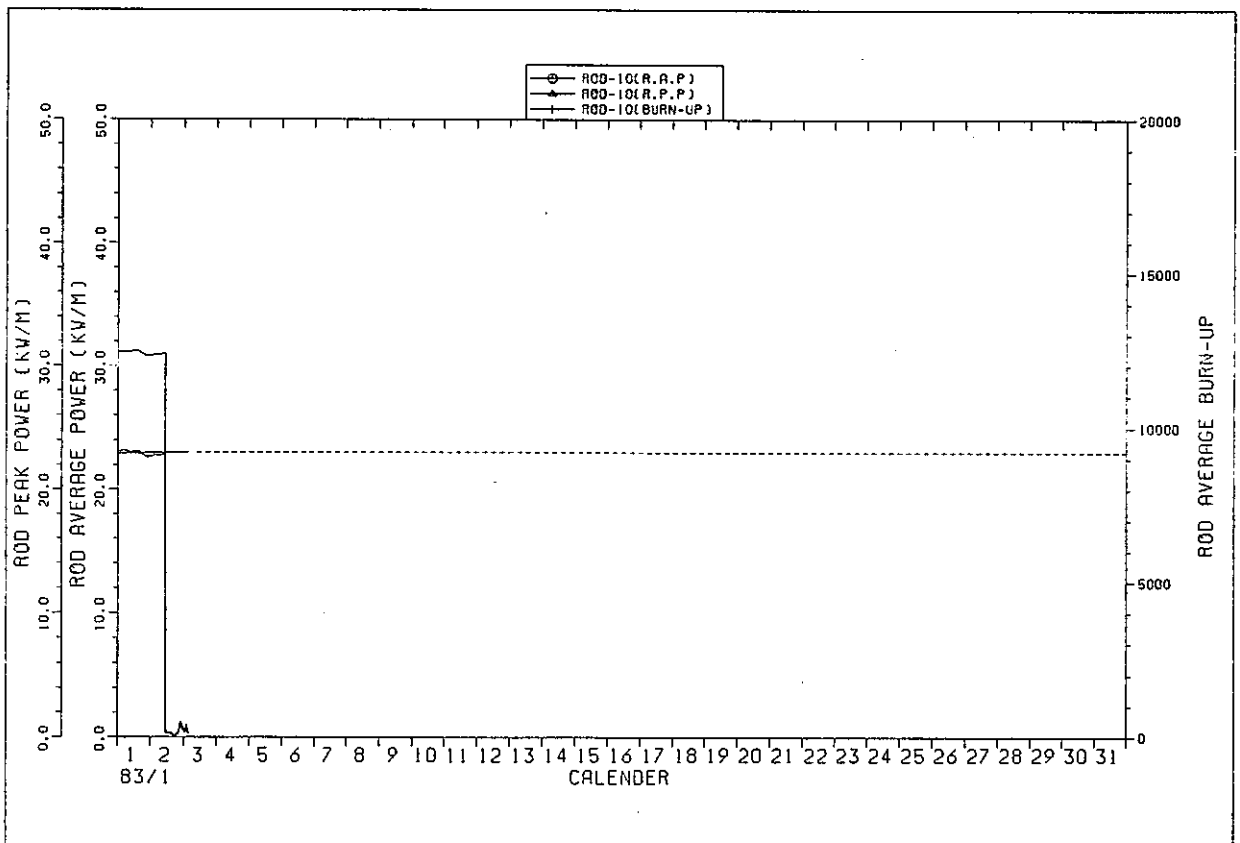

IFA529 ROD POWER HISTORY

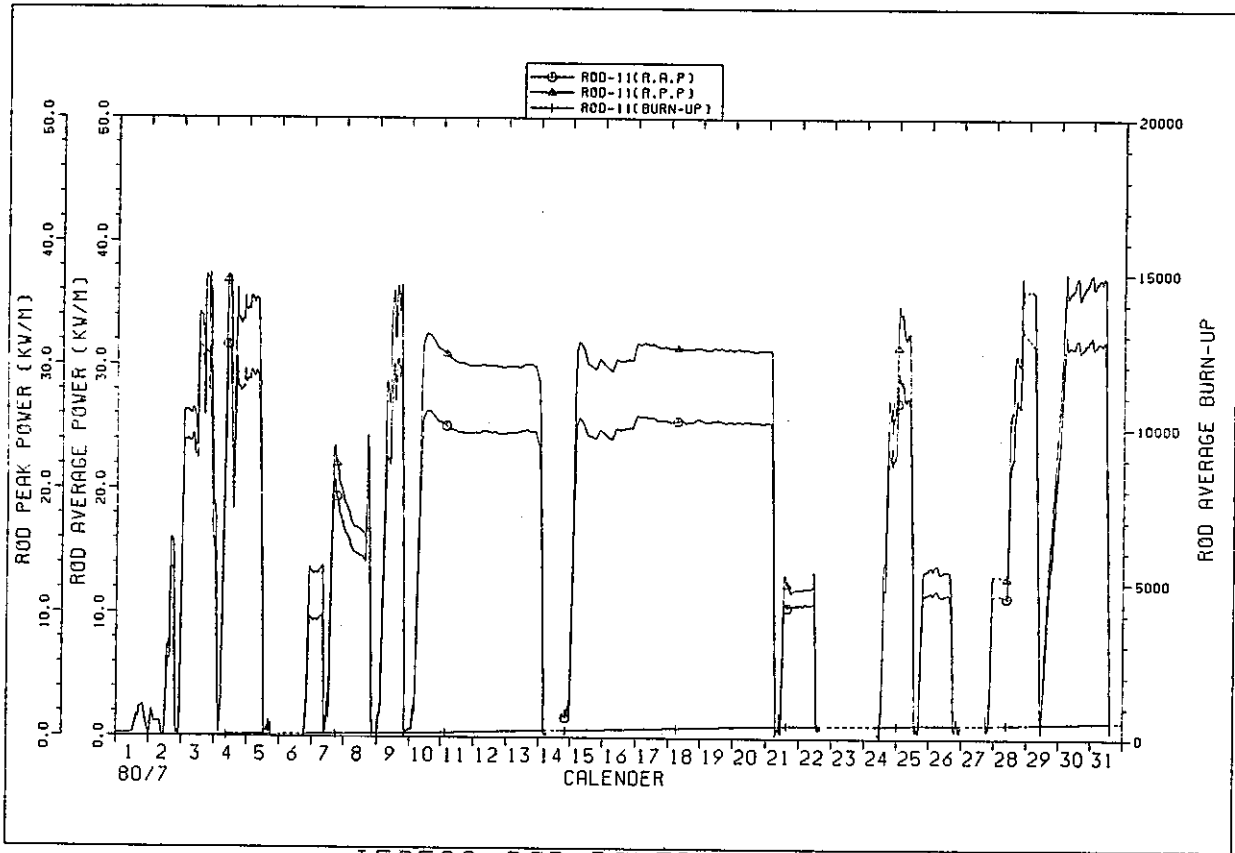

IFA529 ROD POWER HISTORY

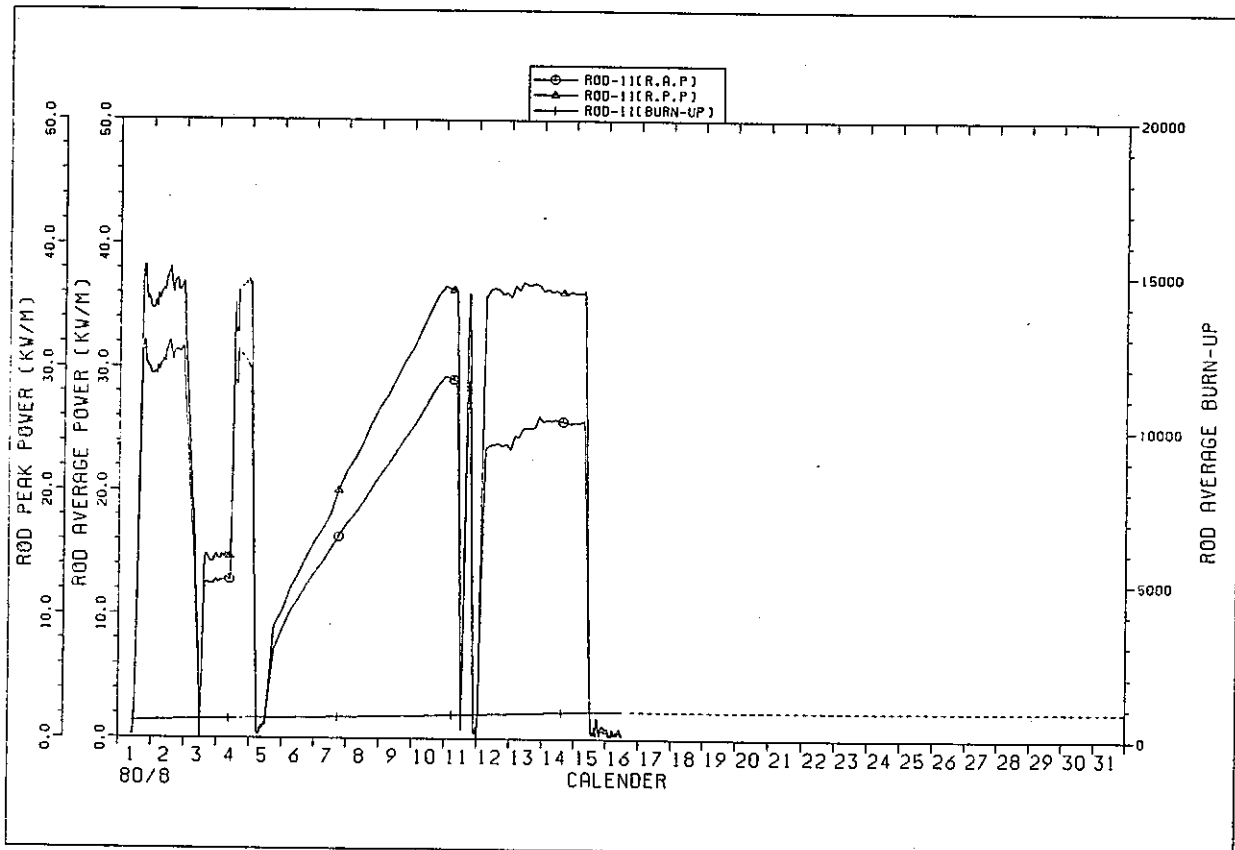

IFA529 ROD POWER HISTORY

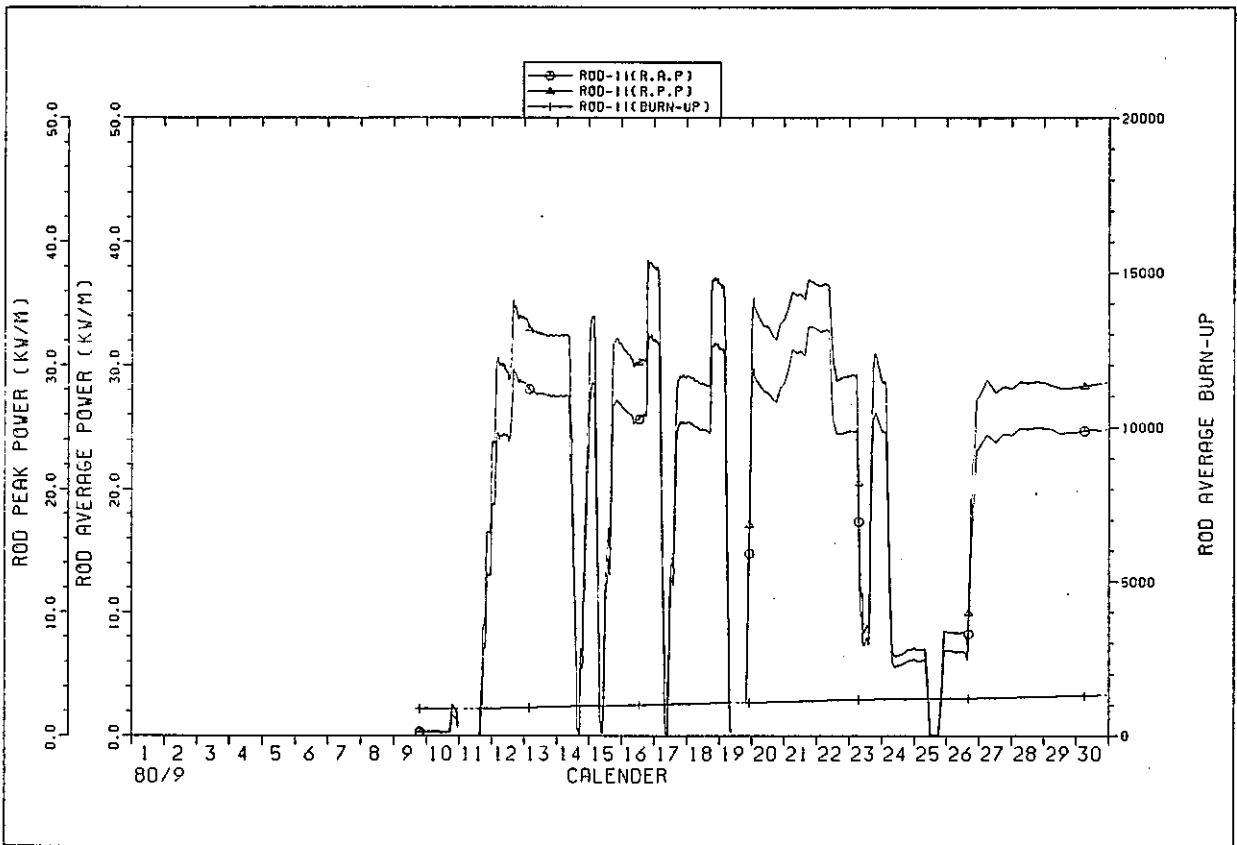

IFA529 ROD POWER HISTORY

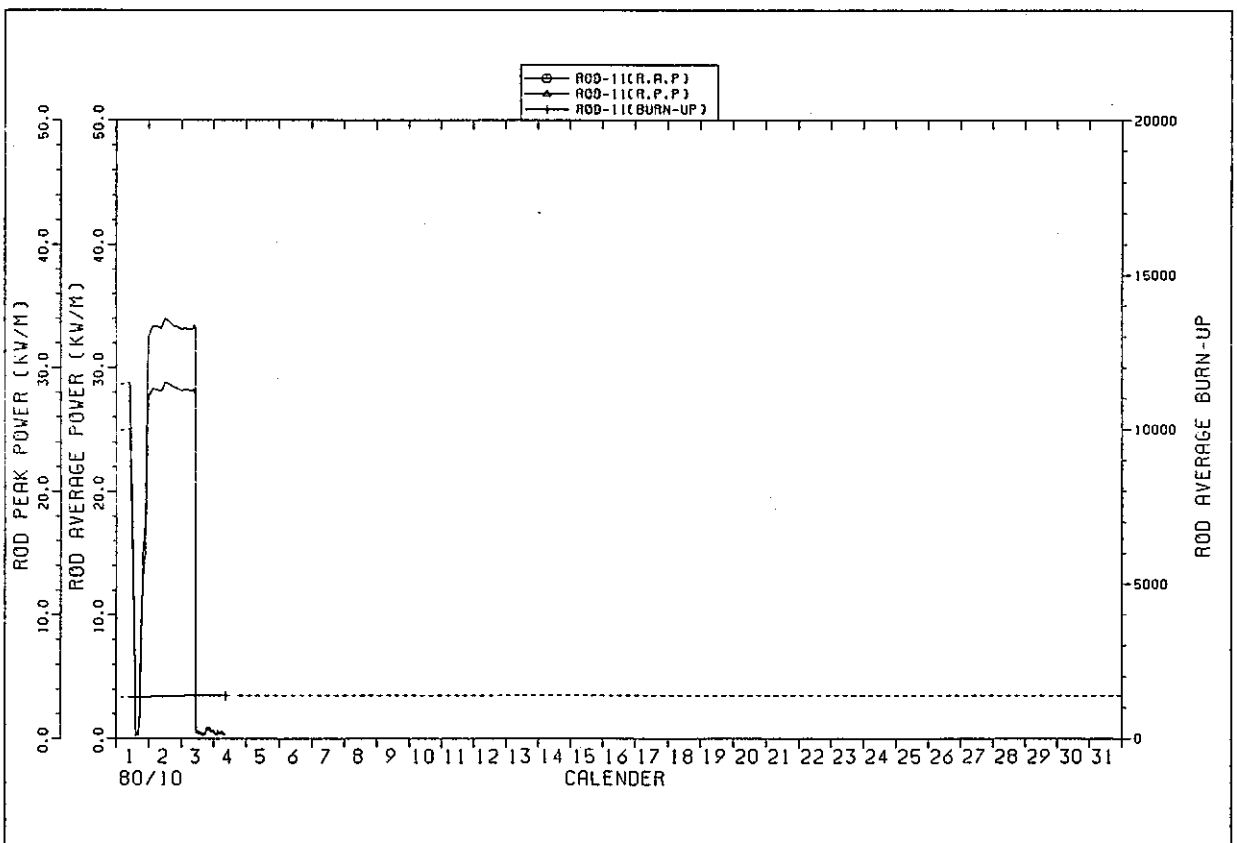

IFA529 ROD POWER HISTORY

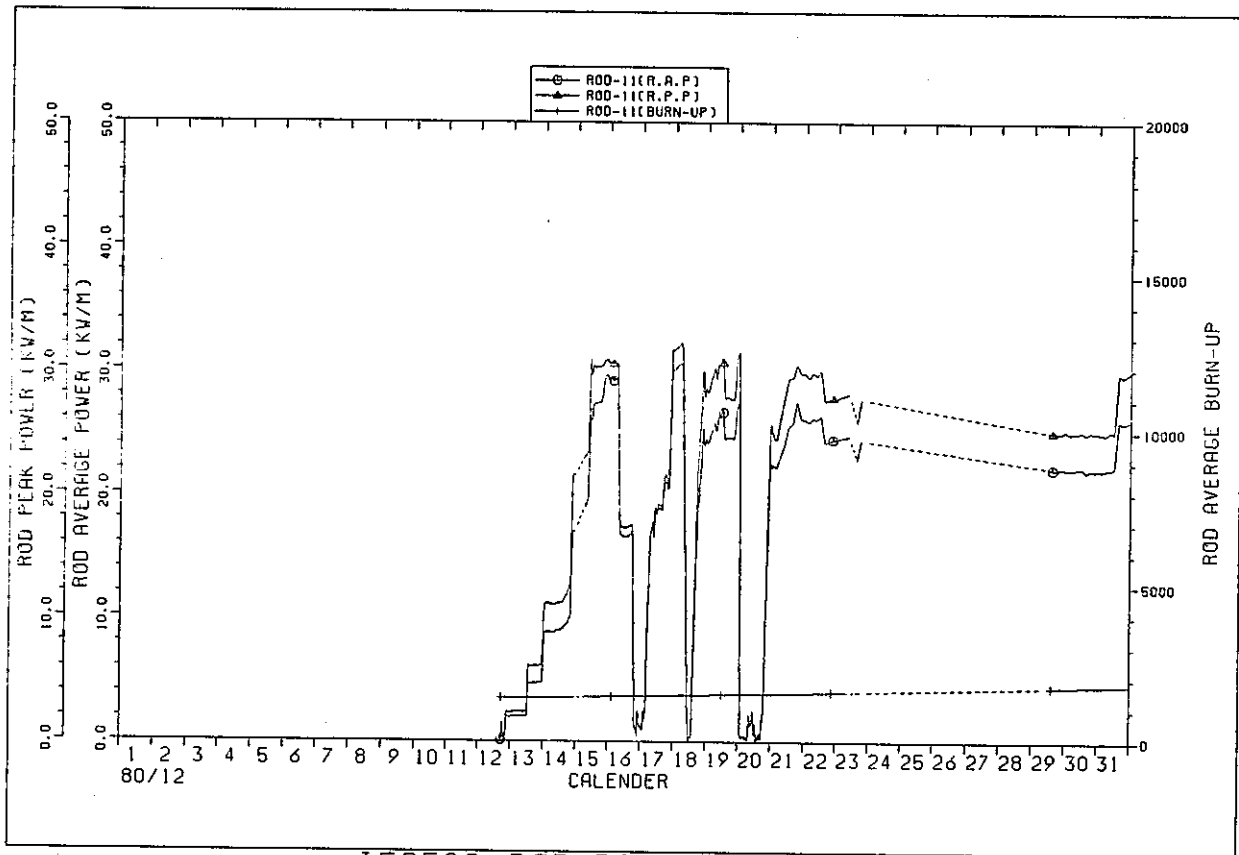

IFA529 ROD POWER HISTORY

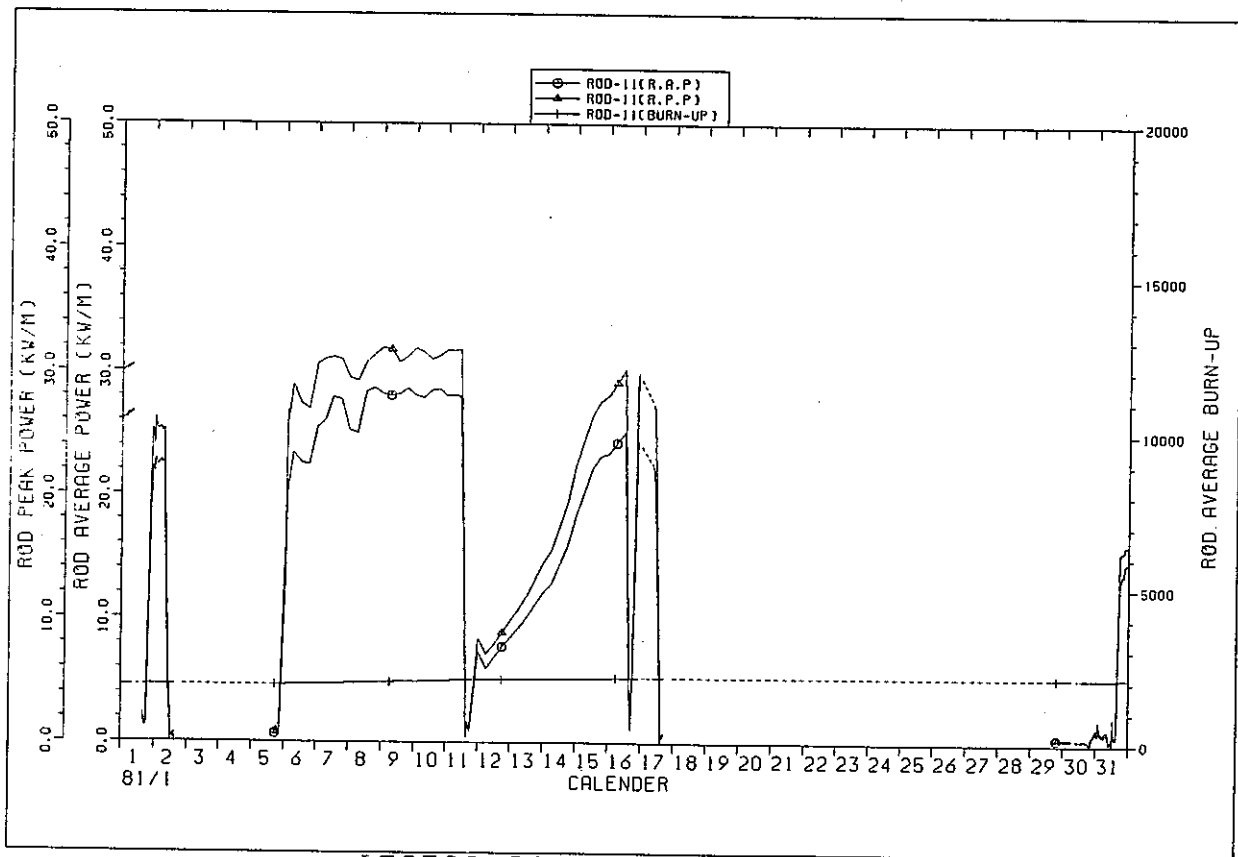

IFA529 ROD POWER HISTORY

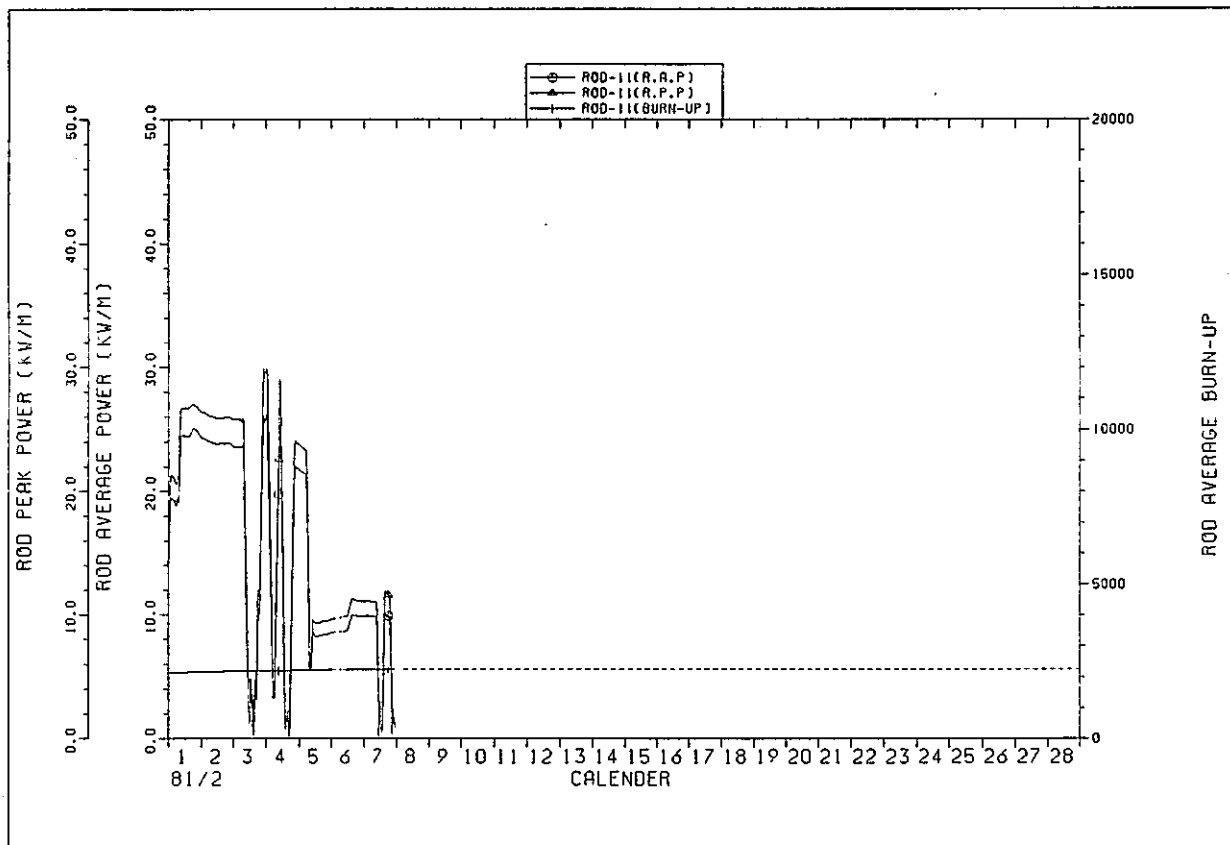

IFA529 ROD POWER HISTORY

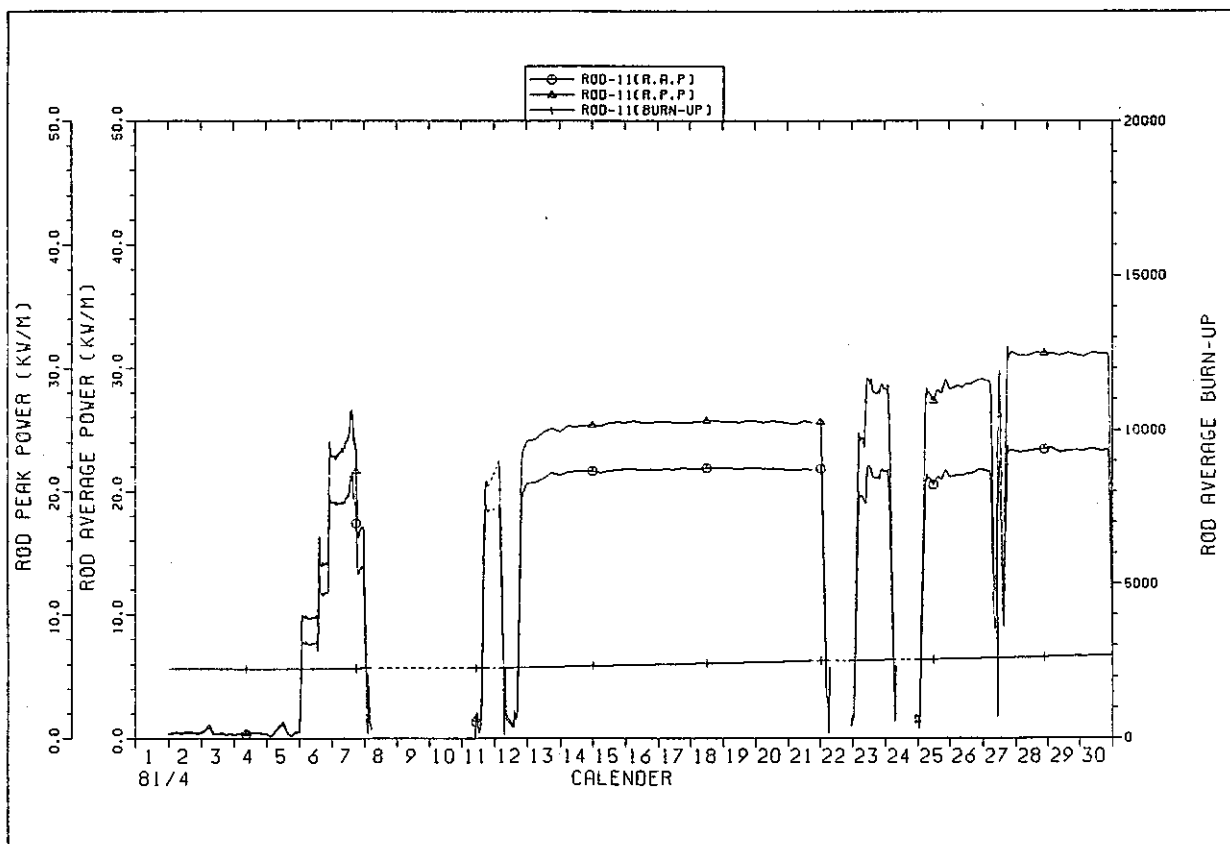

IFA529 ROD POWER HISTORY

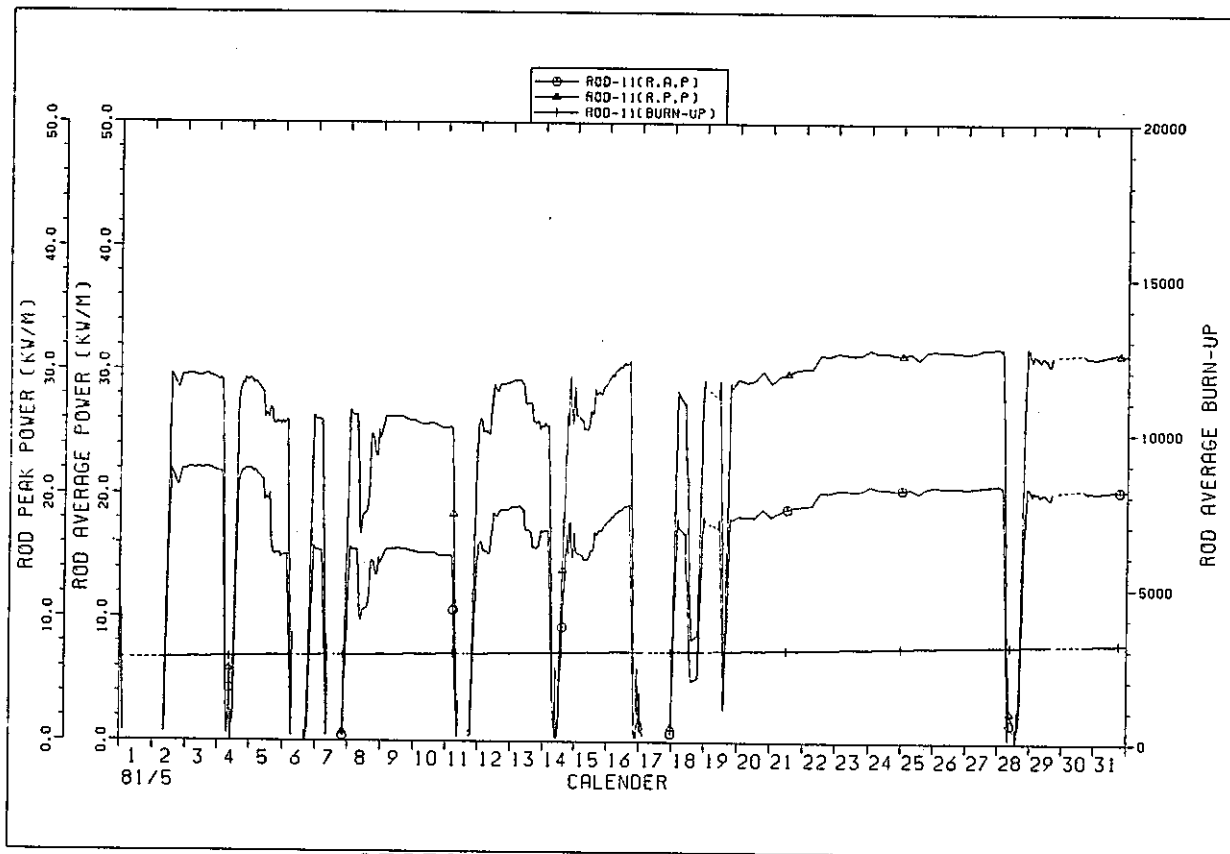

IFA529 ROD POWER HISTORY

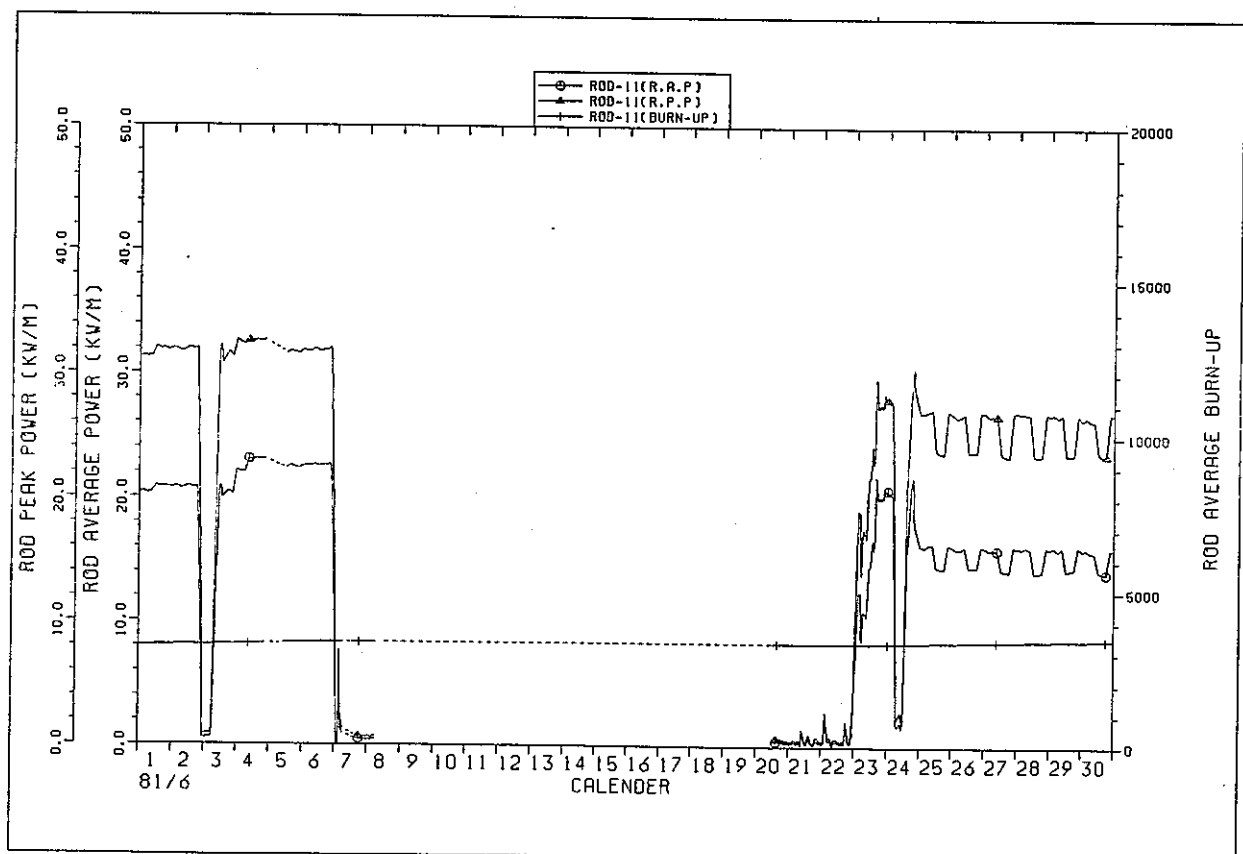

IFA529 ROD POWER HISTORY

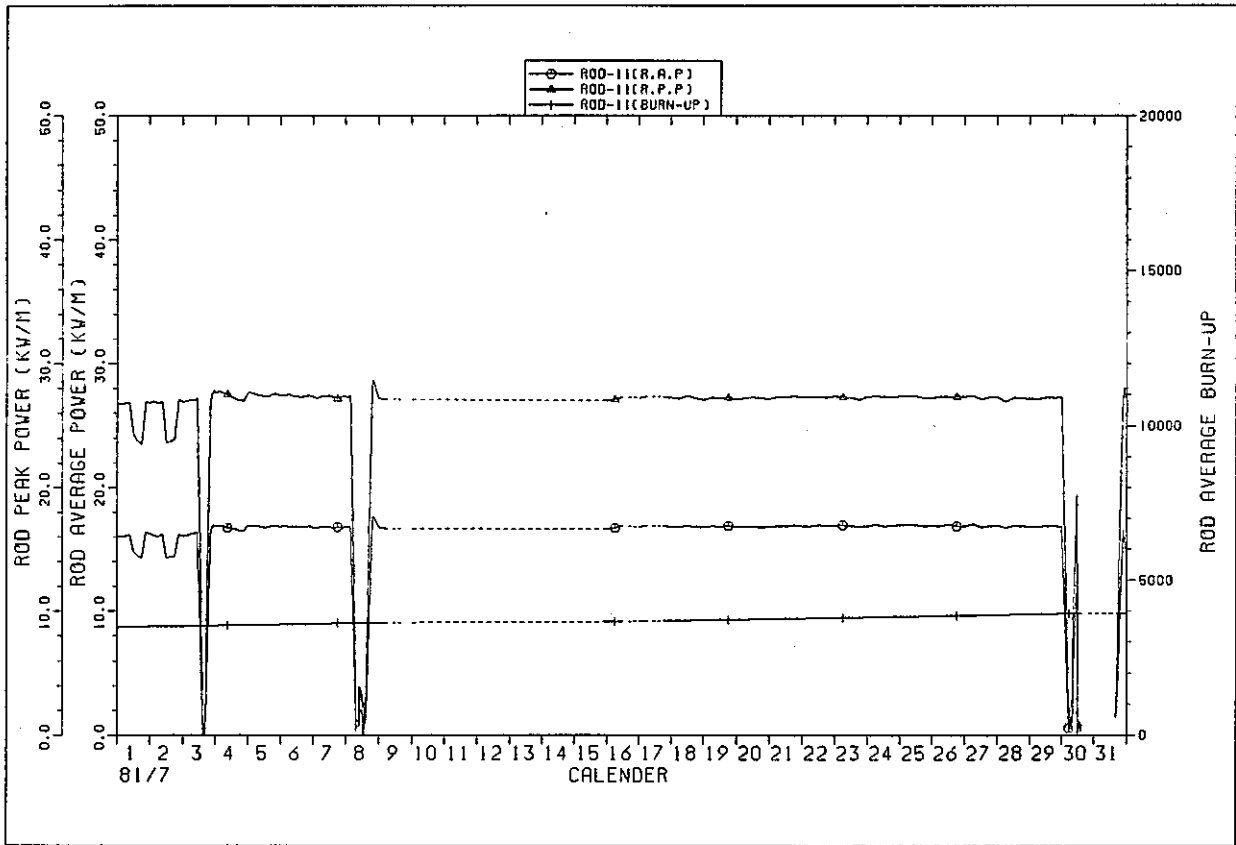

IFA529 ROD POWER HISTORY

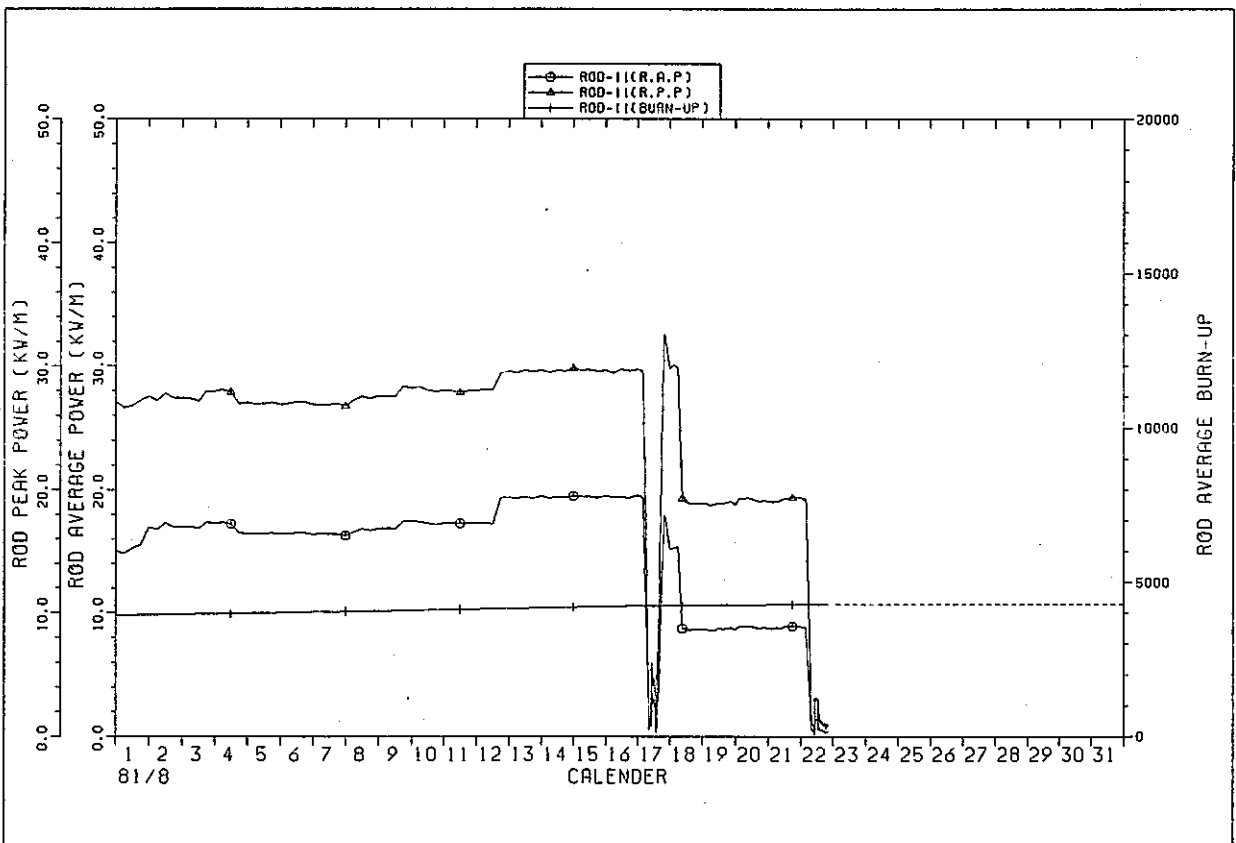

IFA529 ROD POWER HISTORY

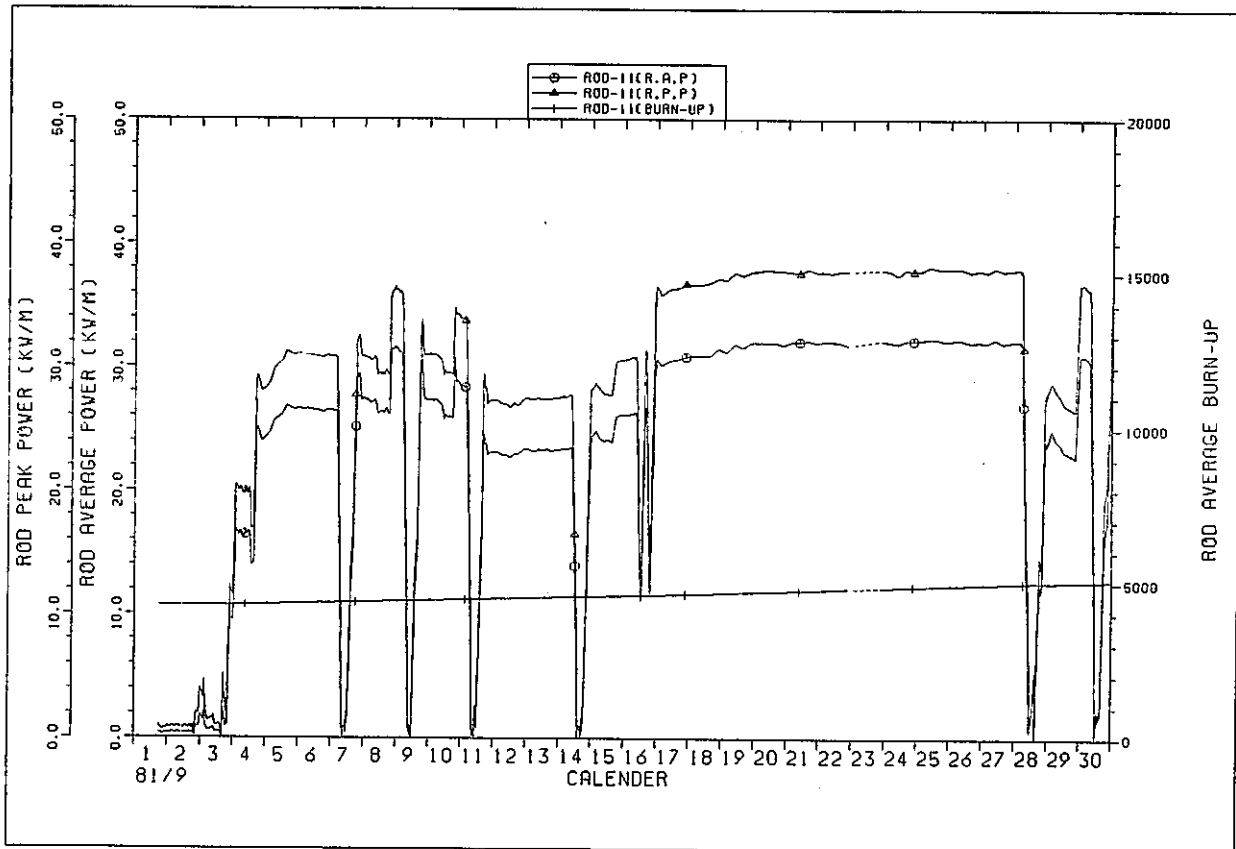

IFA529 ROD POWER HISTORY

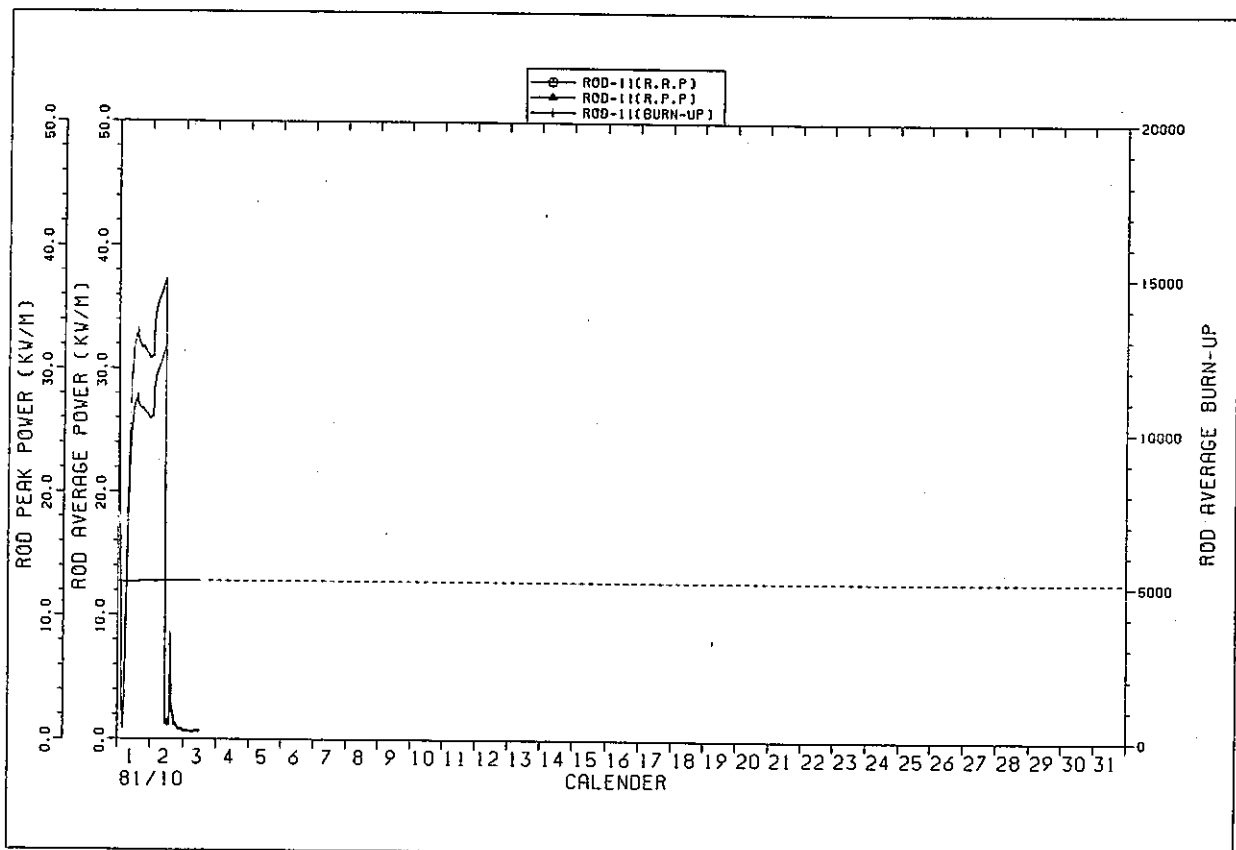

IFA529 ROD POWER HISTORY

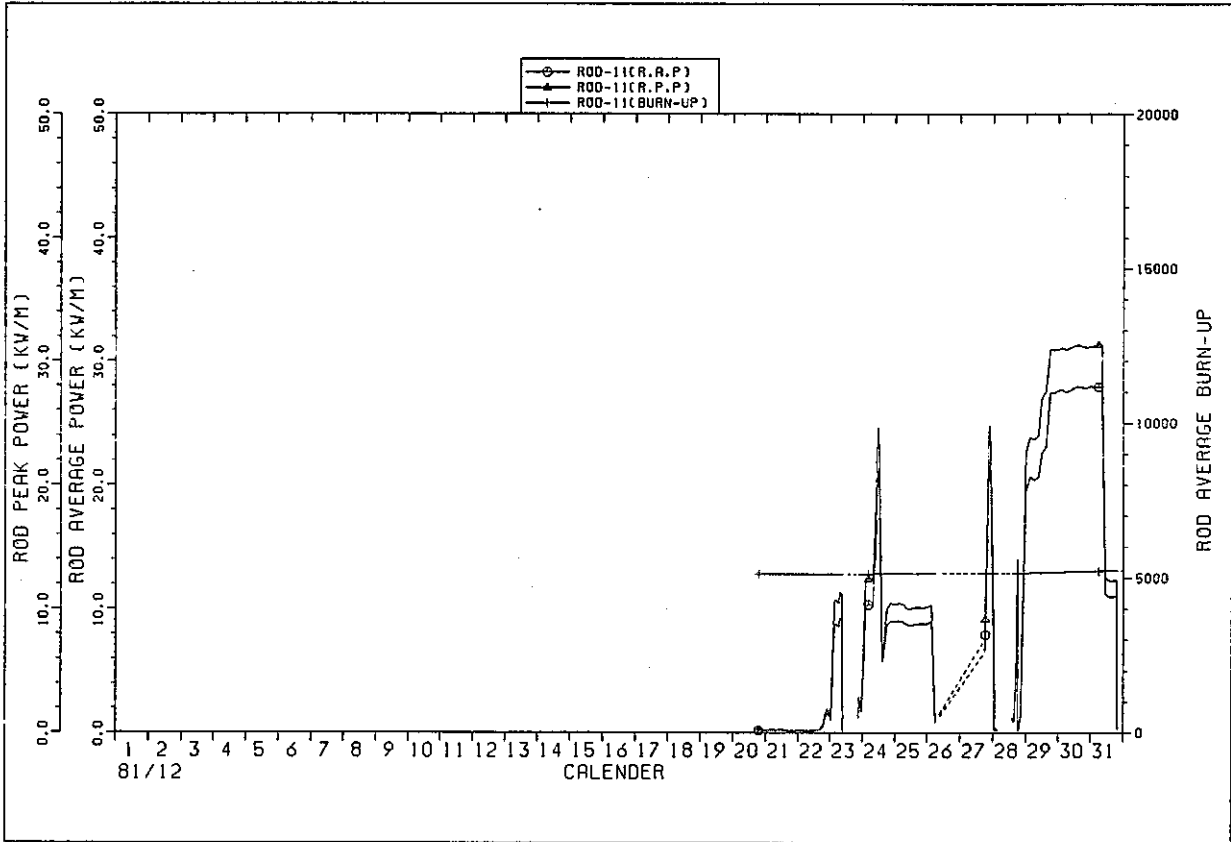

IFA529 ROD POWER HISTORY

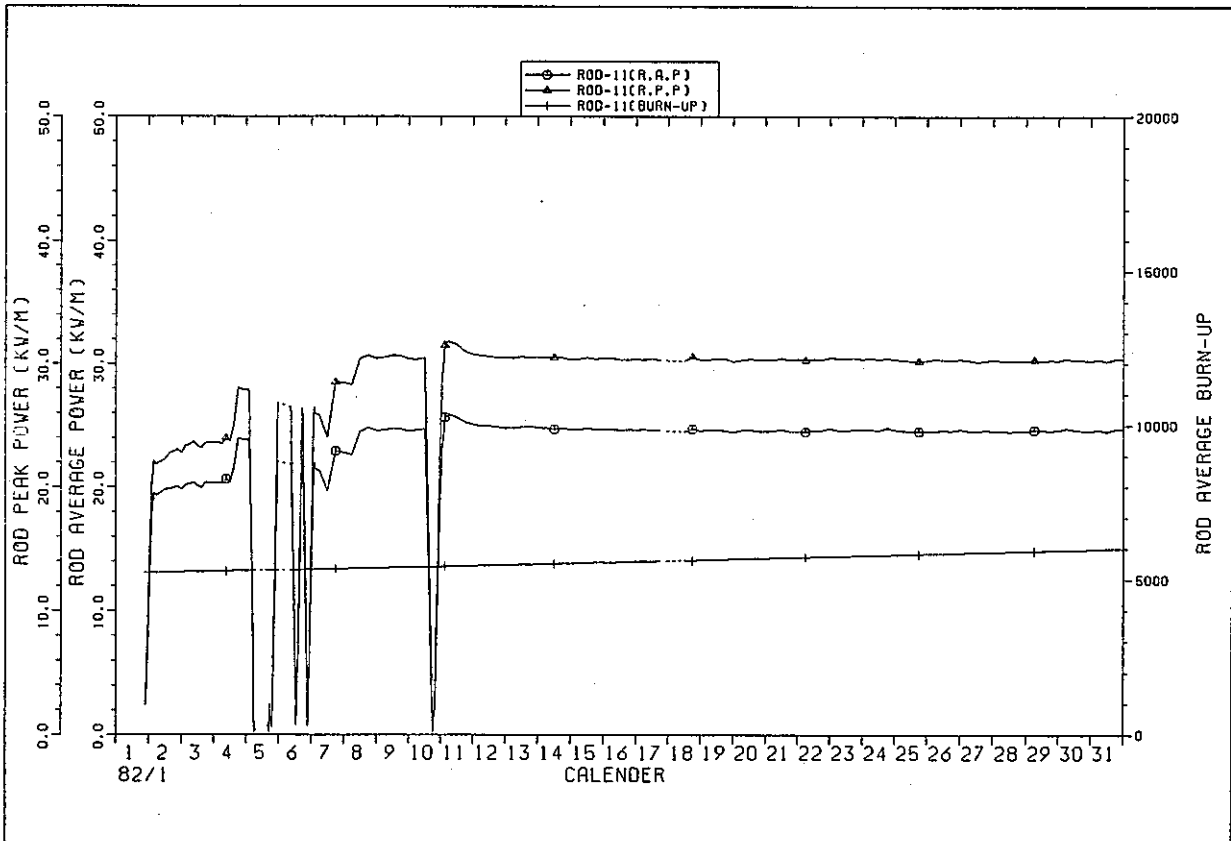

IFA529 ROD POWER HISTORY

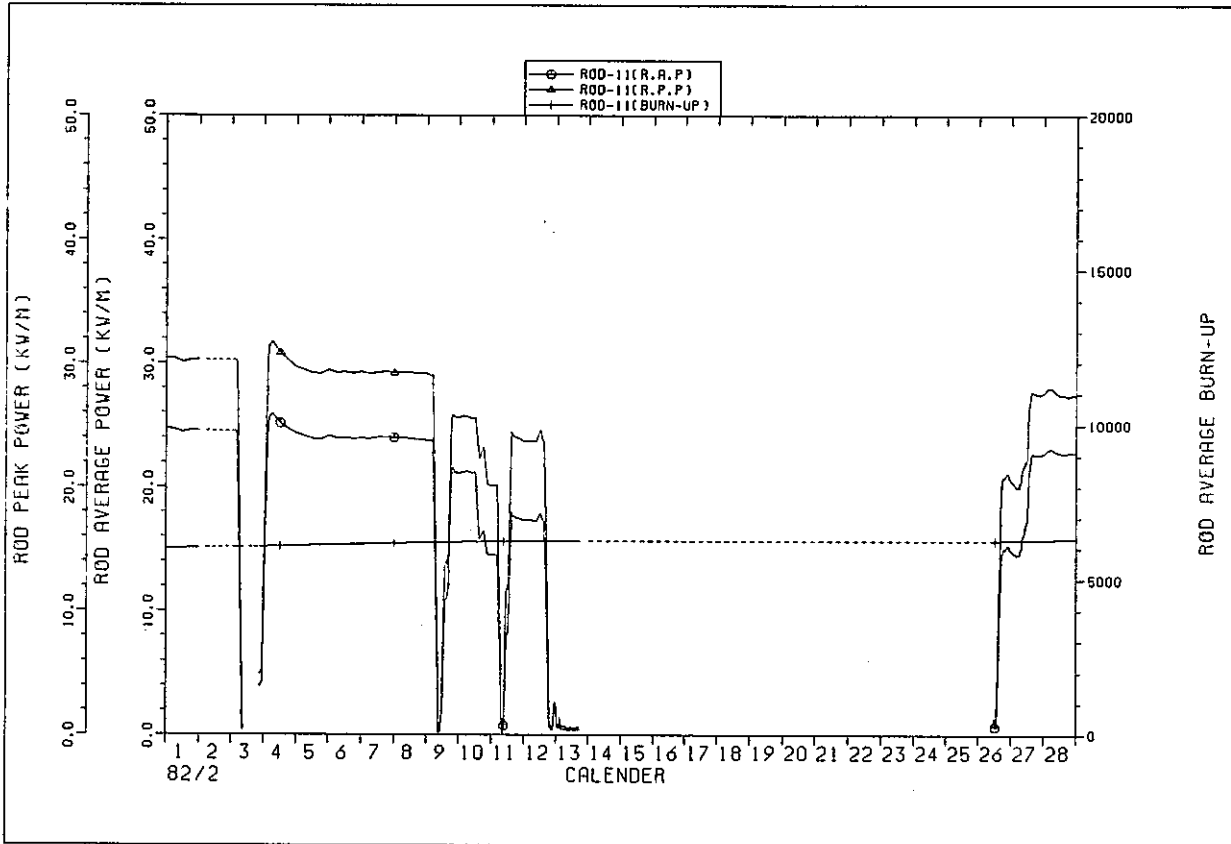

IFA529 ROD POWER HISTORY

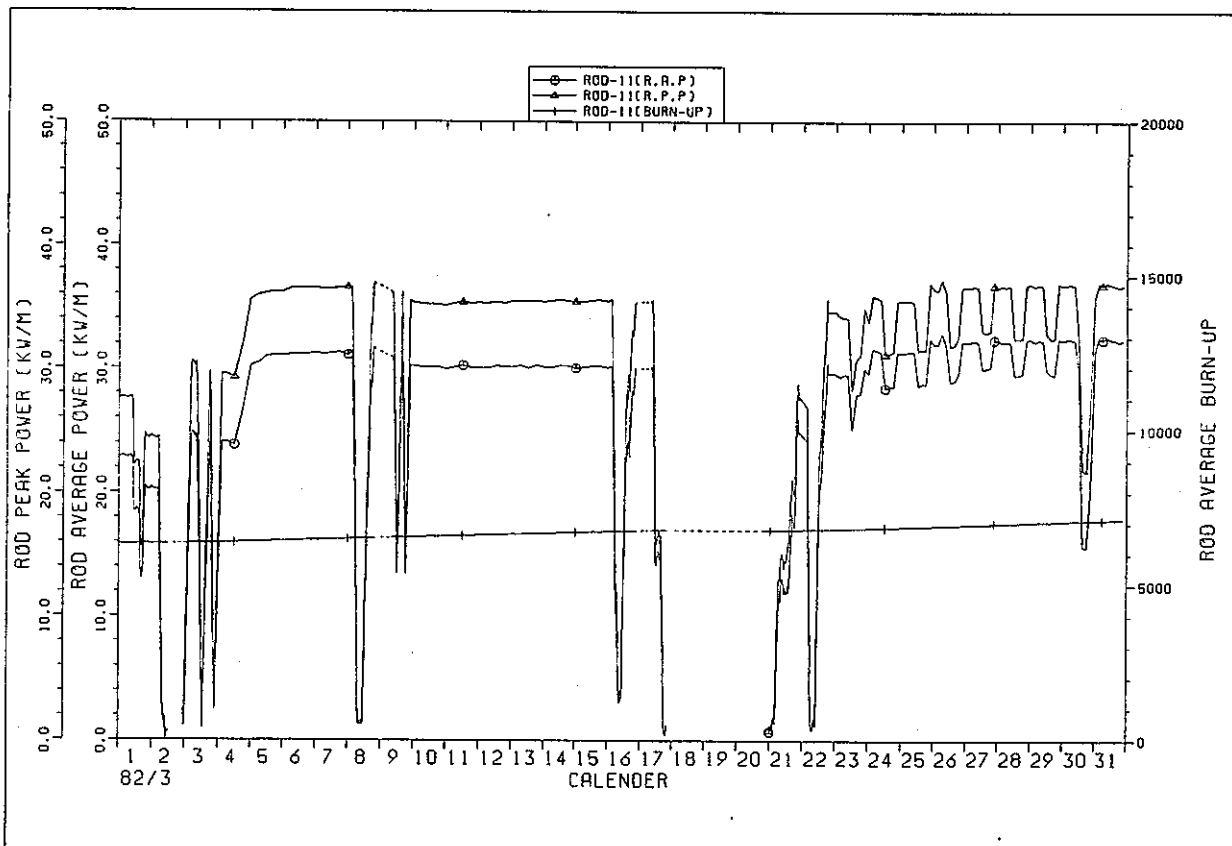

IFA529 ROD POWER HISTORY

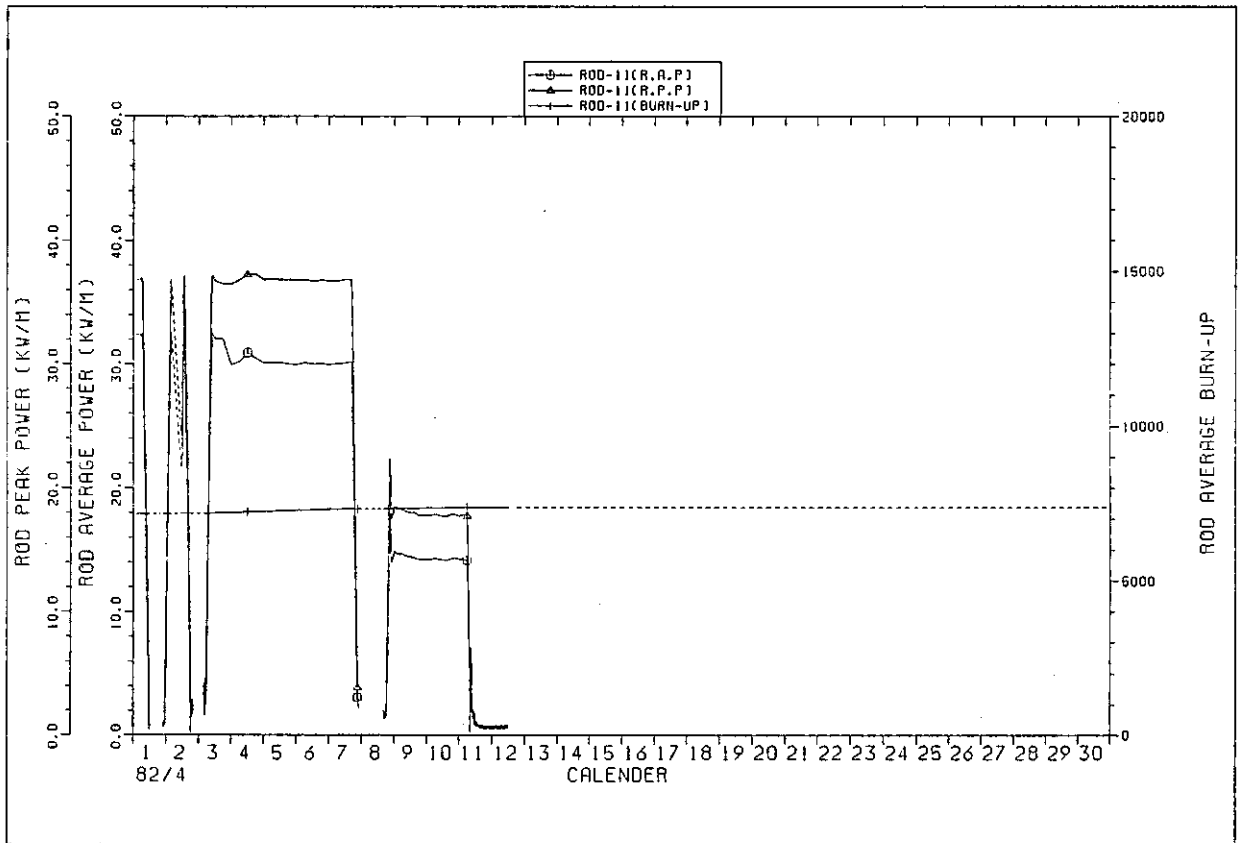

IFA529 ROD POWER HISTORY

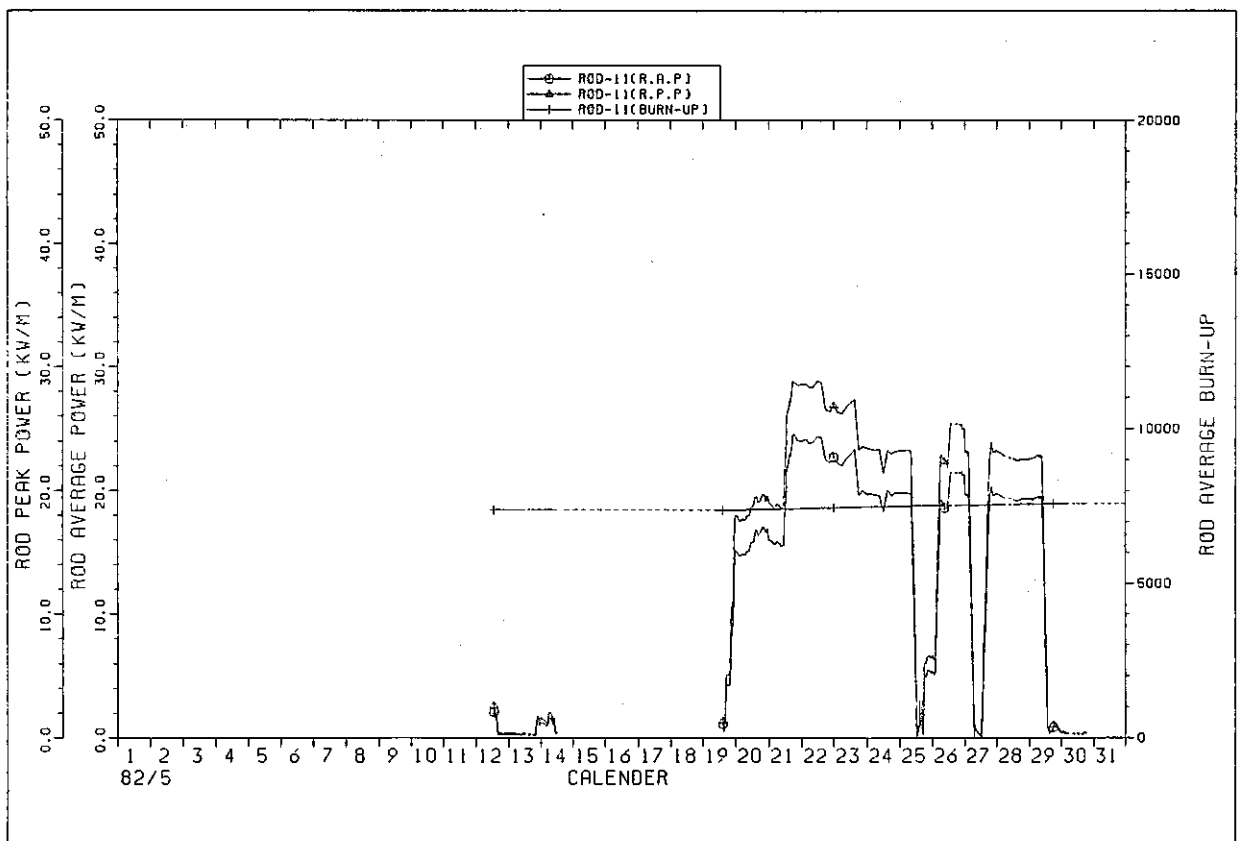

IFA529 ROD POWER HISTORY

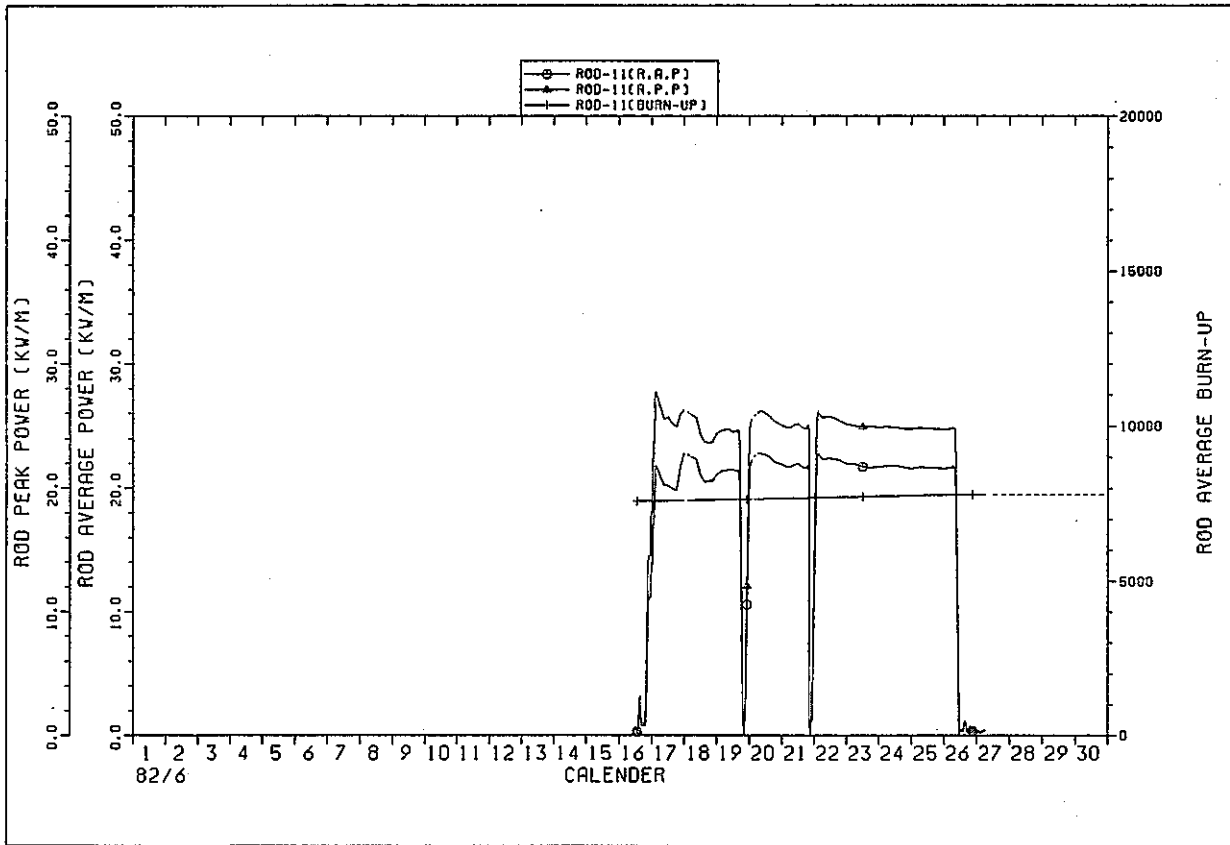

IFA529 ROD POWER HISTORY

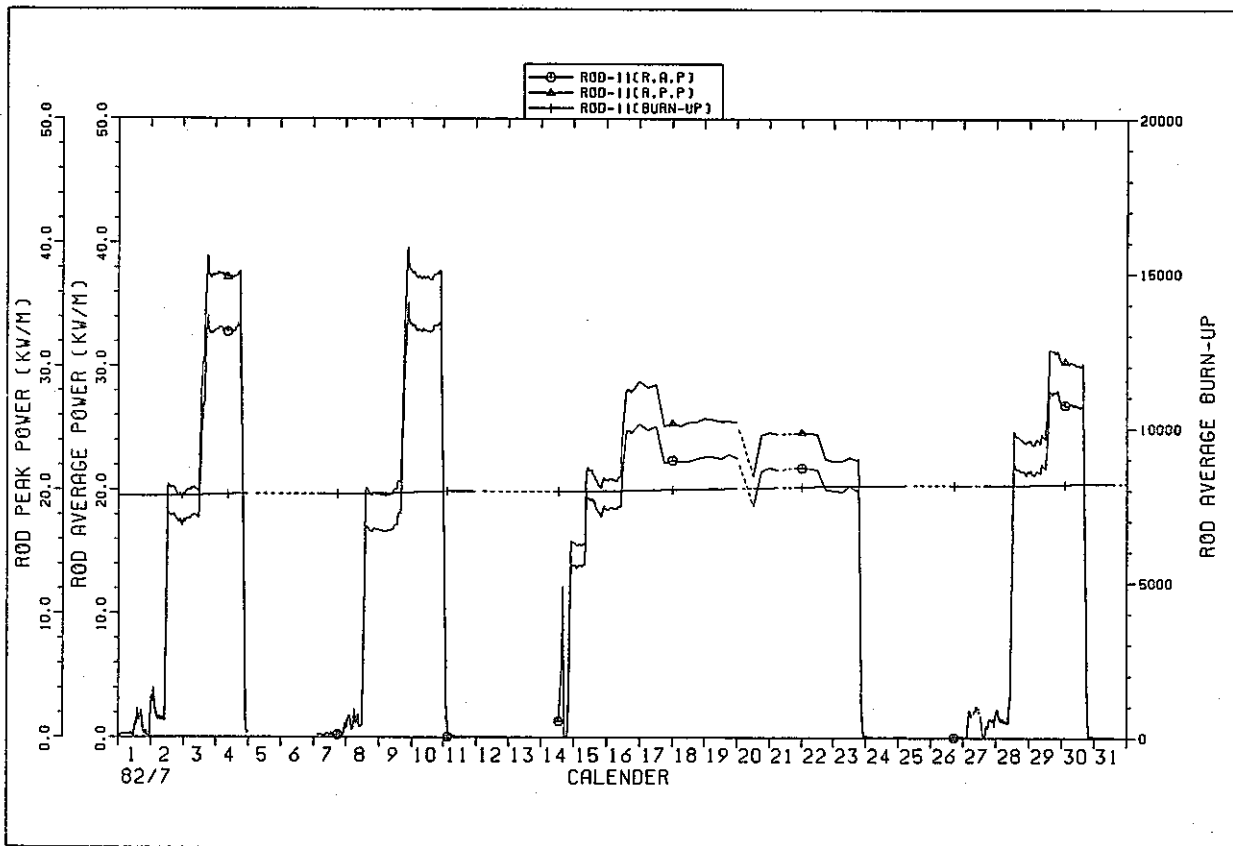

IFA529 ROD POWER HISTORY

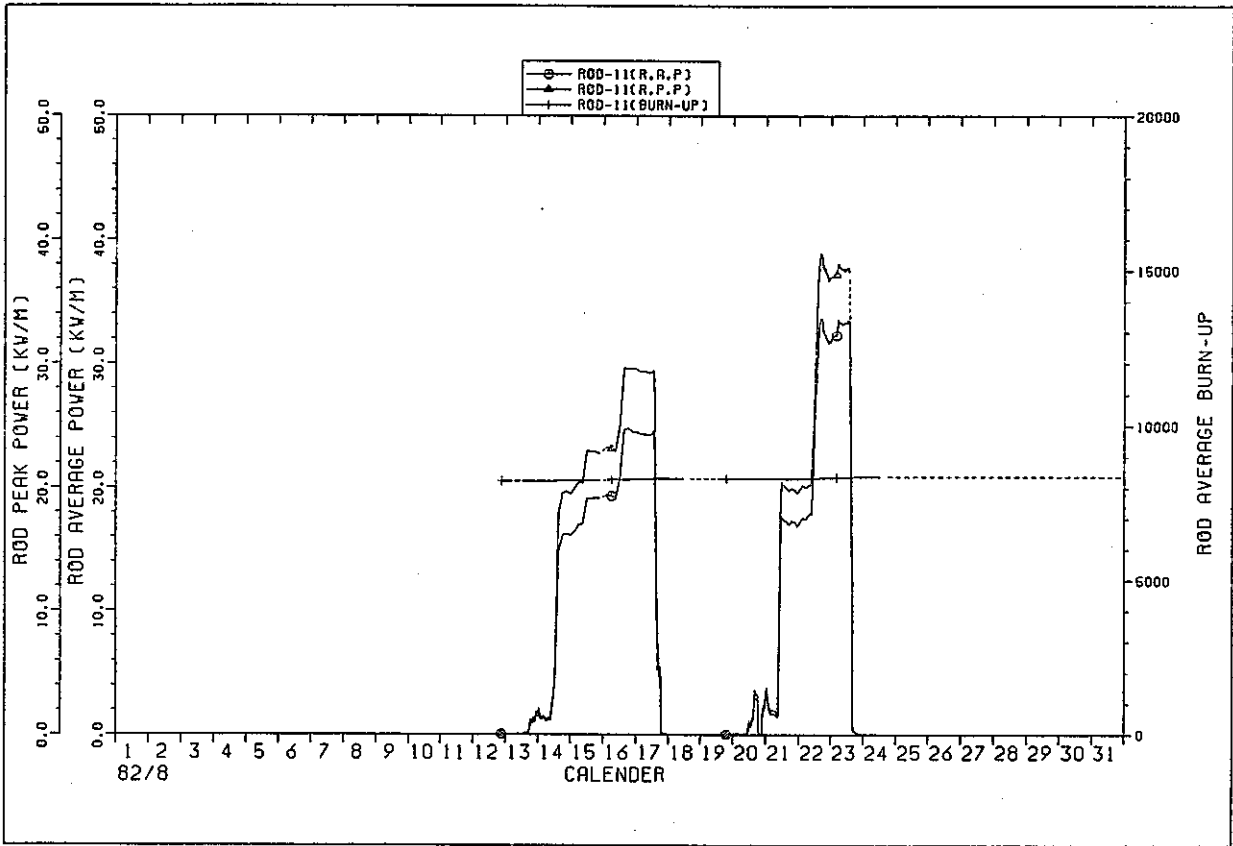

IFA529 ROD POWER HISTORY

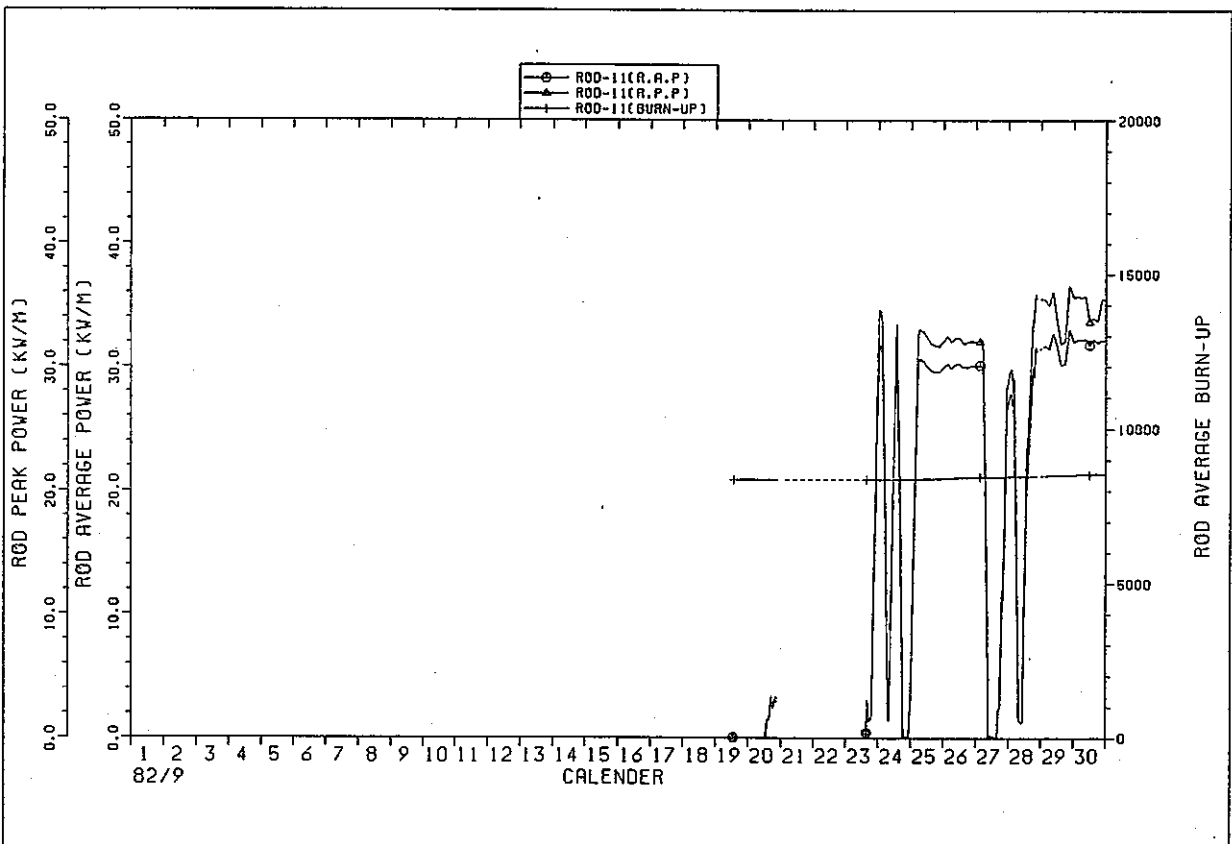

IFA529 ROD POWER HISTORY

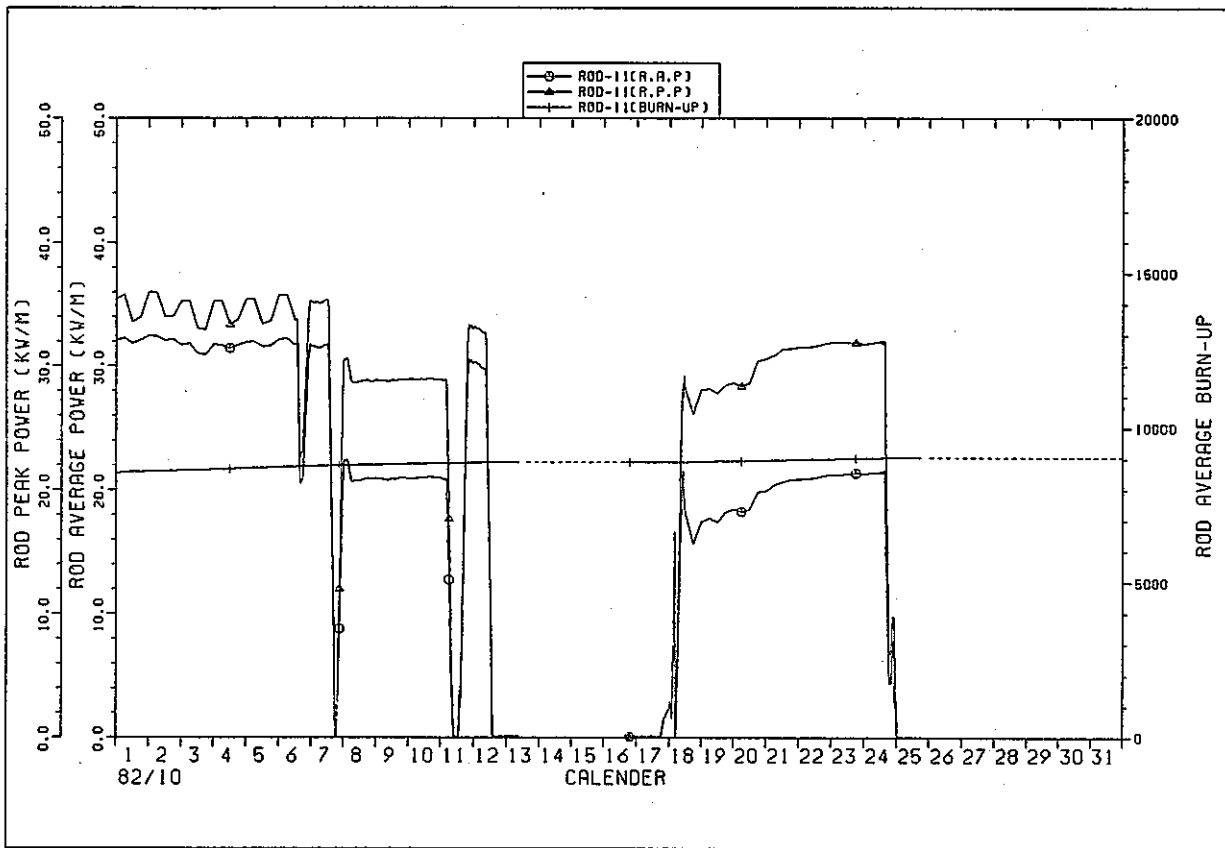

IFA529 ROD POWER HISTORY

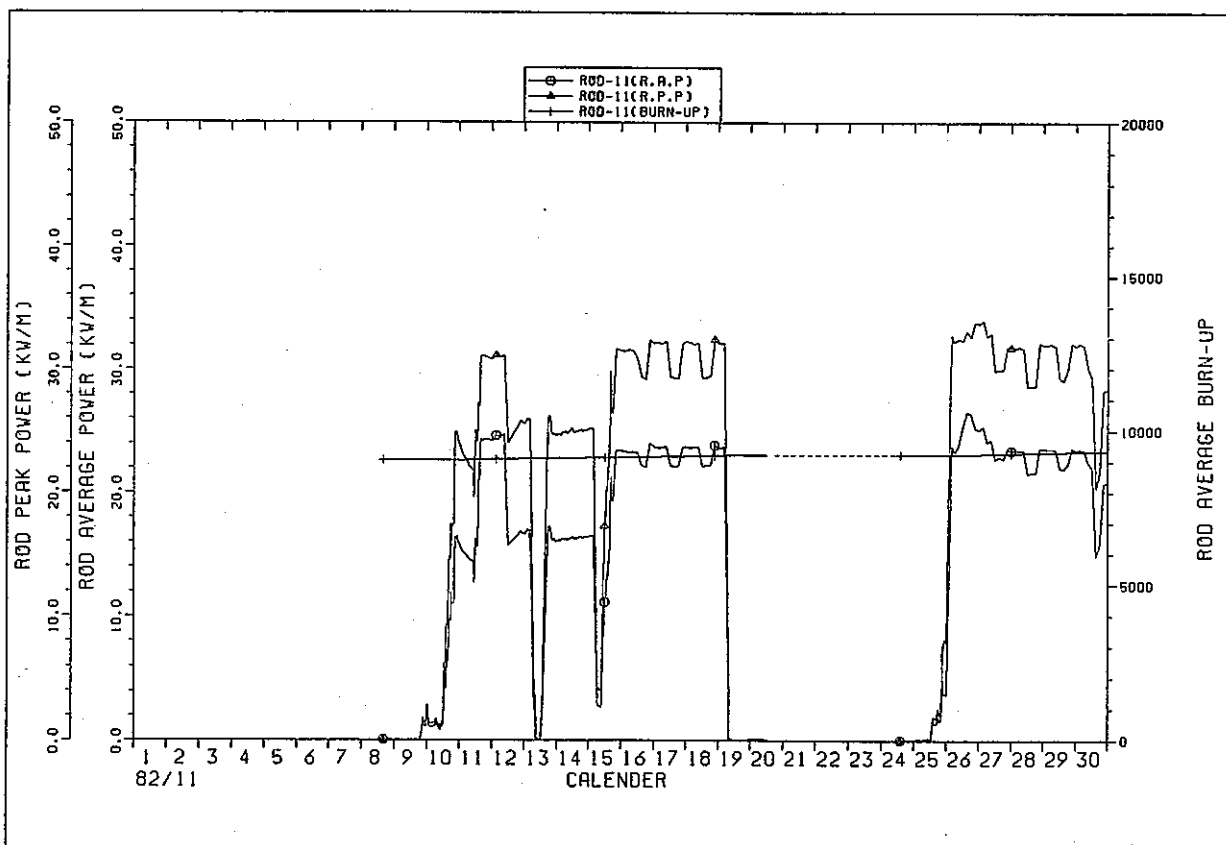

IFA529 ROD POWER HISTORY

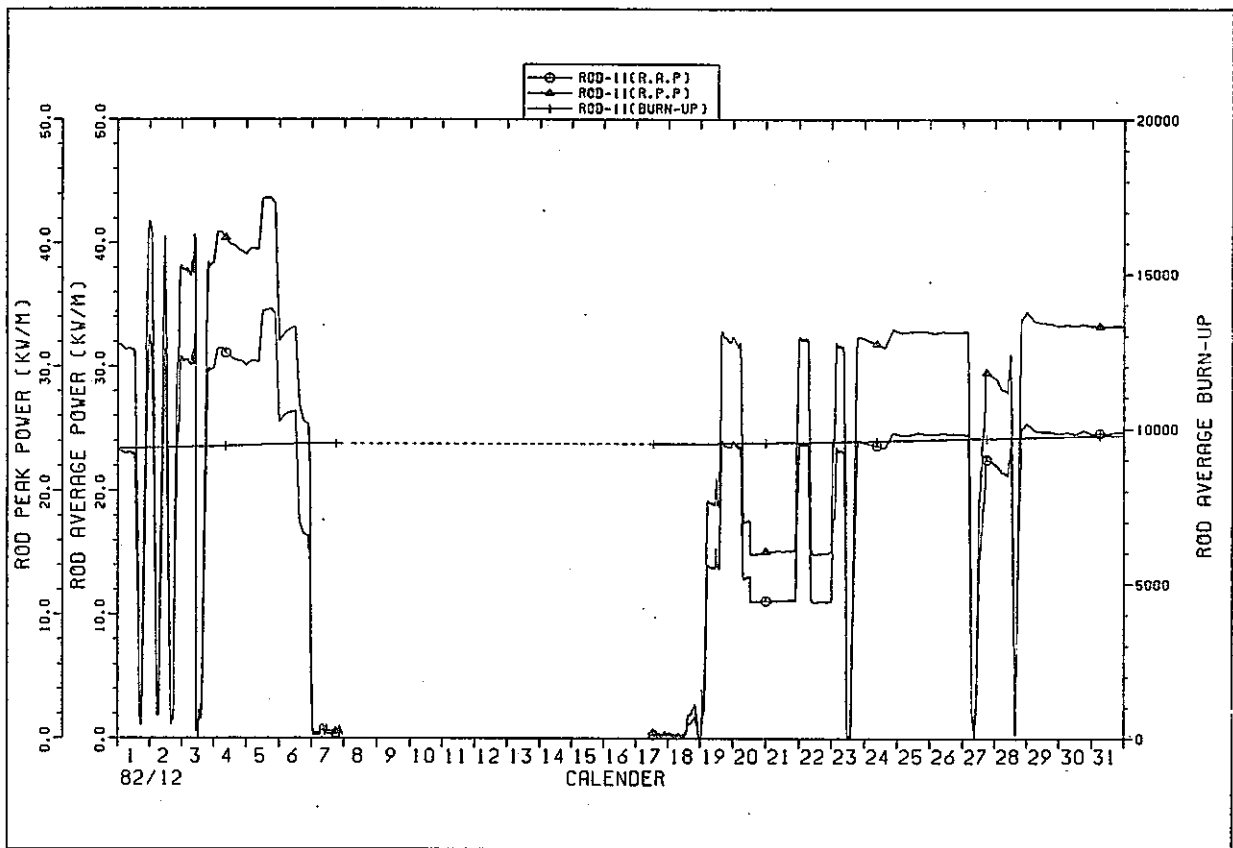

IFA529 ROD POWER HISTORY

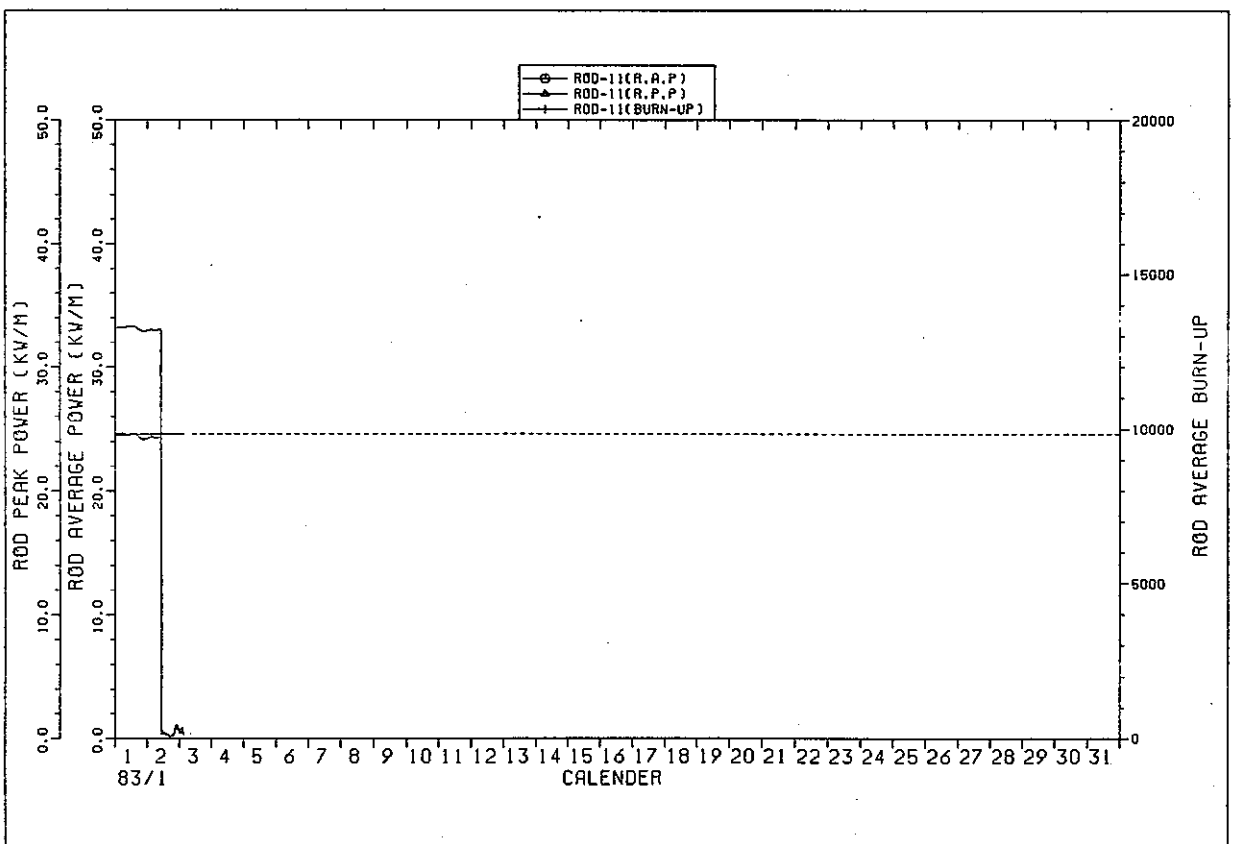

IFA529 ROD POWER HISTORY

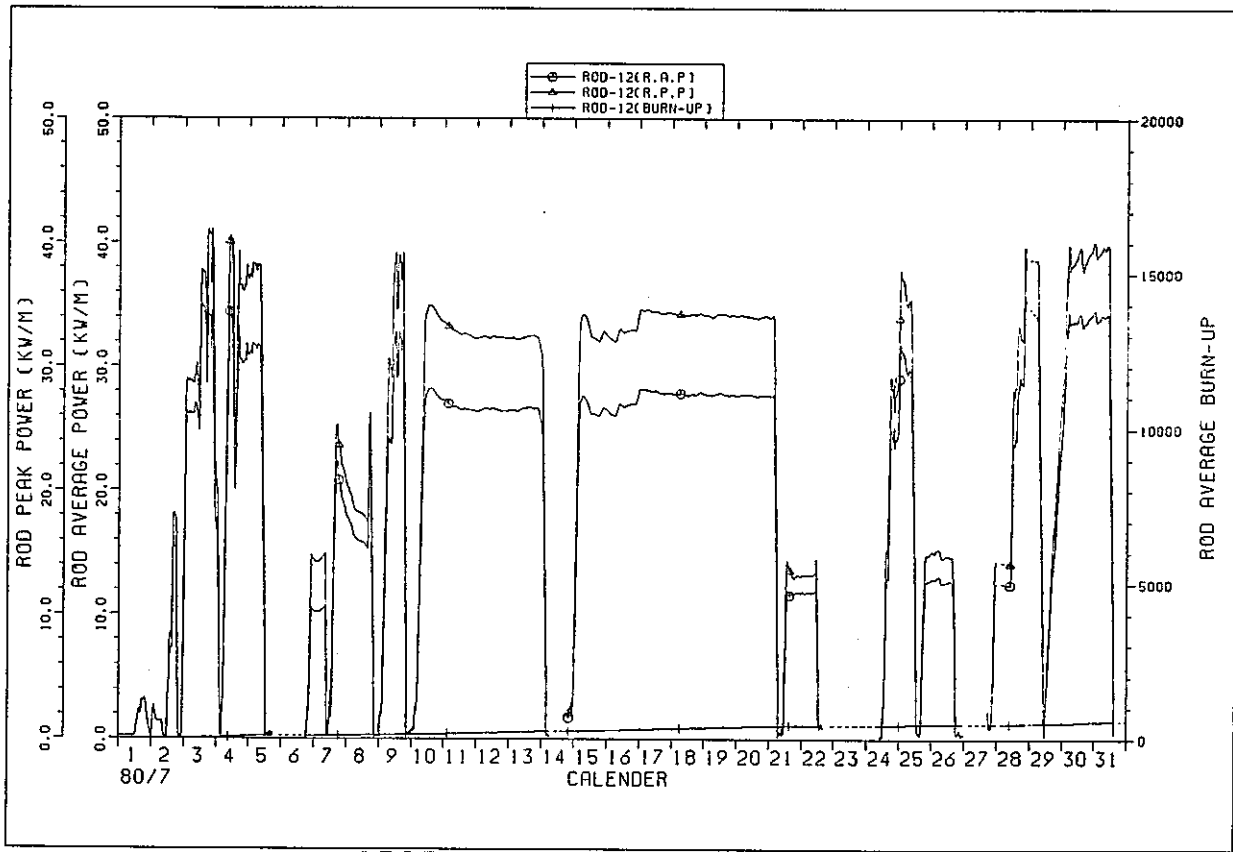

IFA529 ROD POWER HISTORY

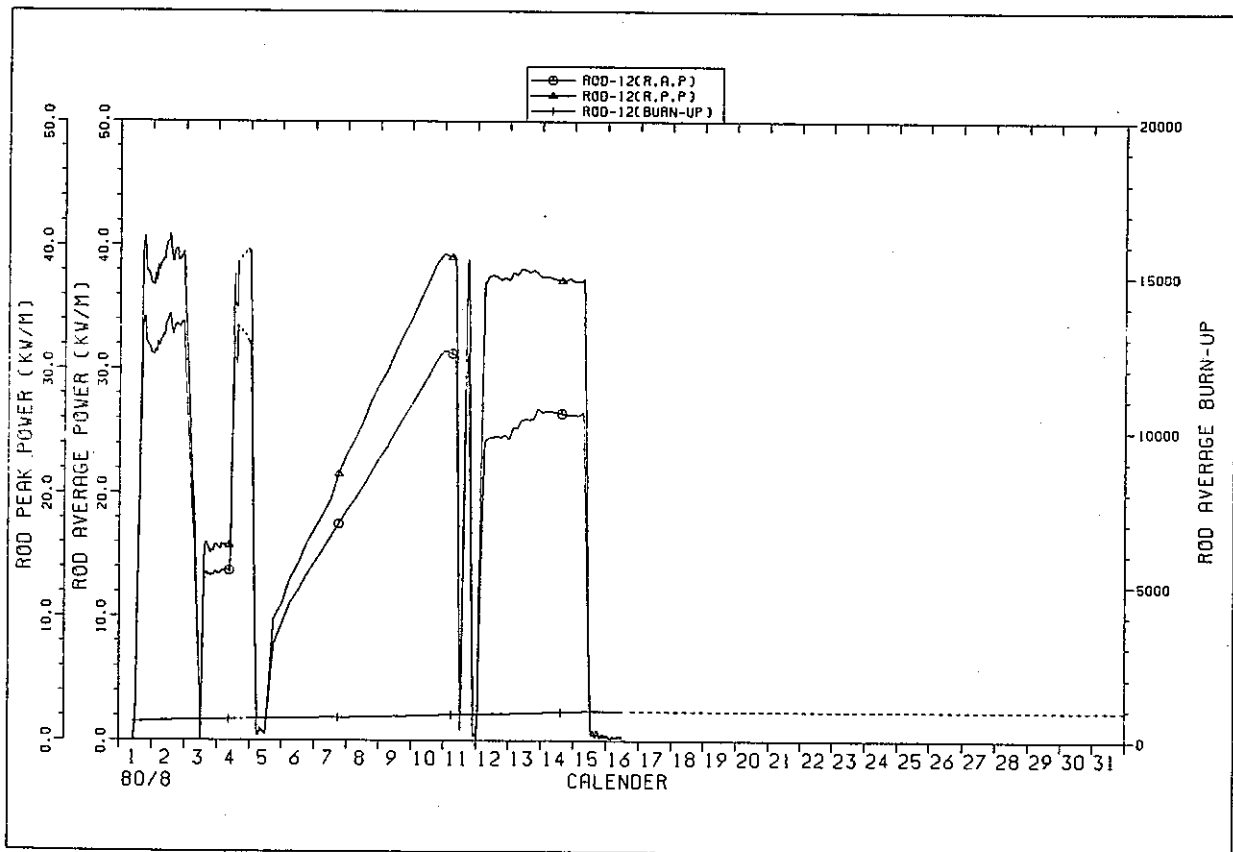

IFA529 ROD POWER HISTORY

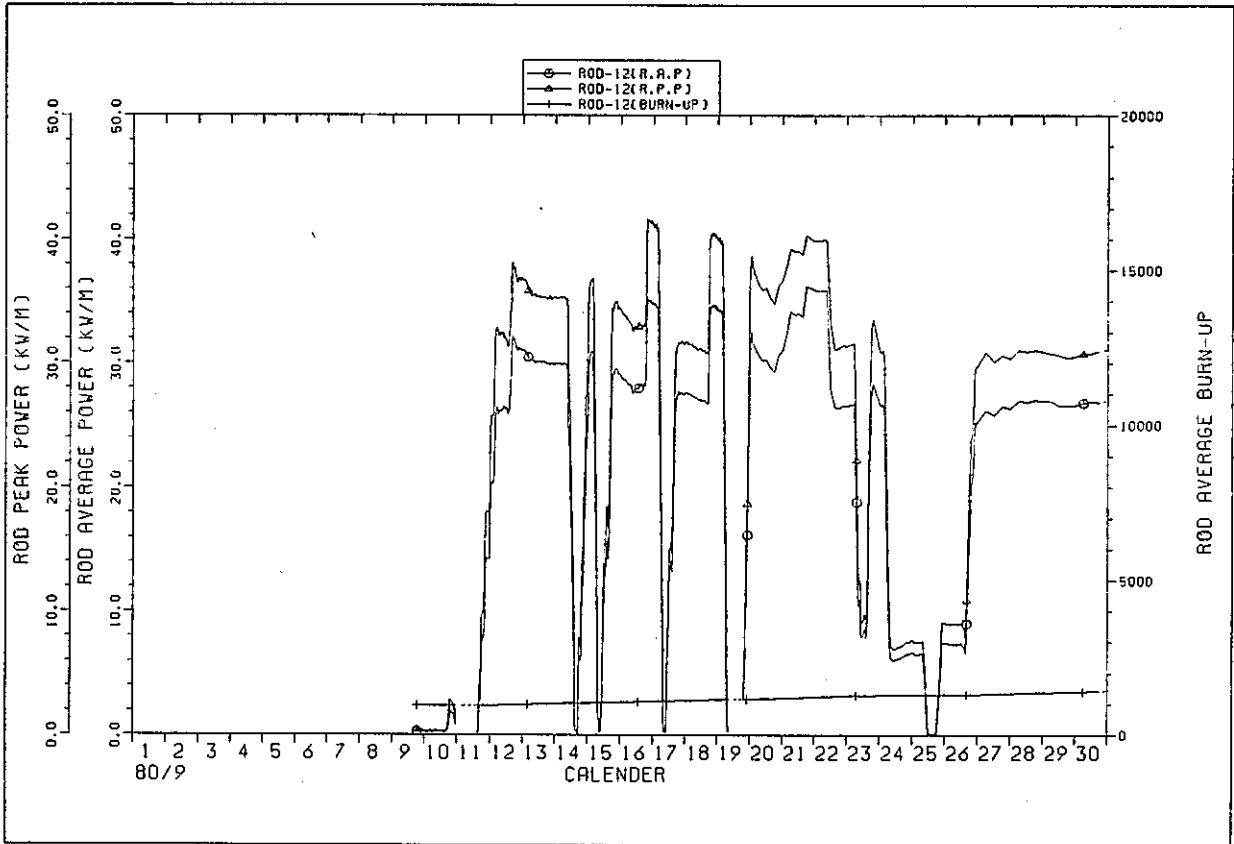

IFA529 ROD POWER HISTORY

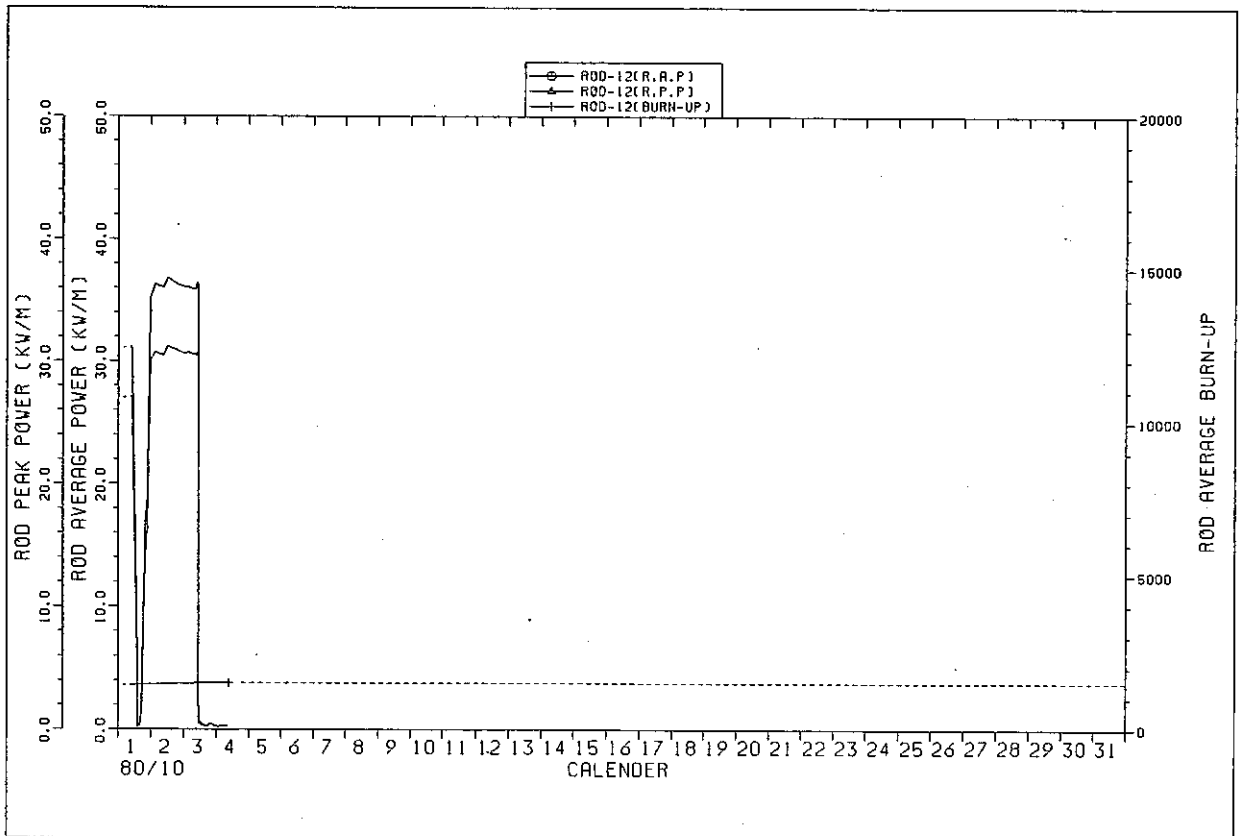

IFA529 ROD POWER HISTORY

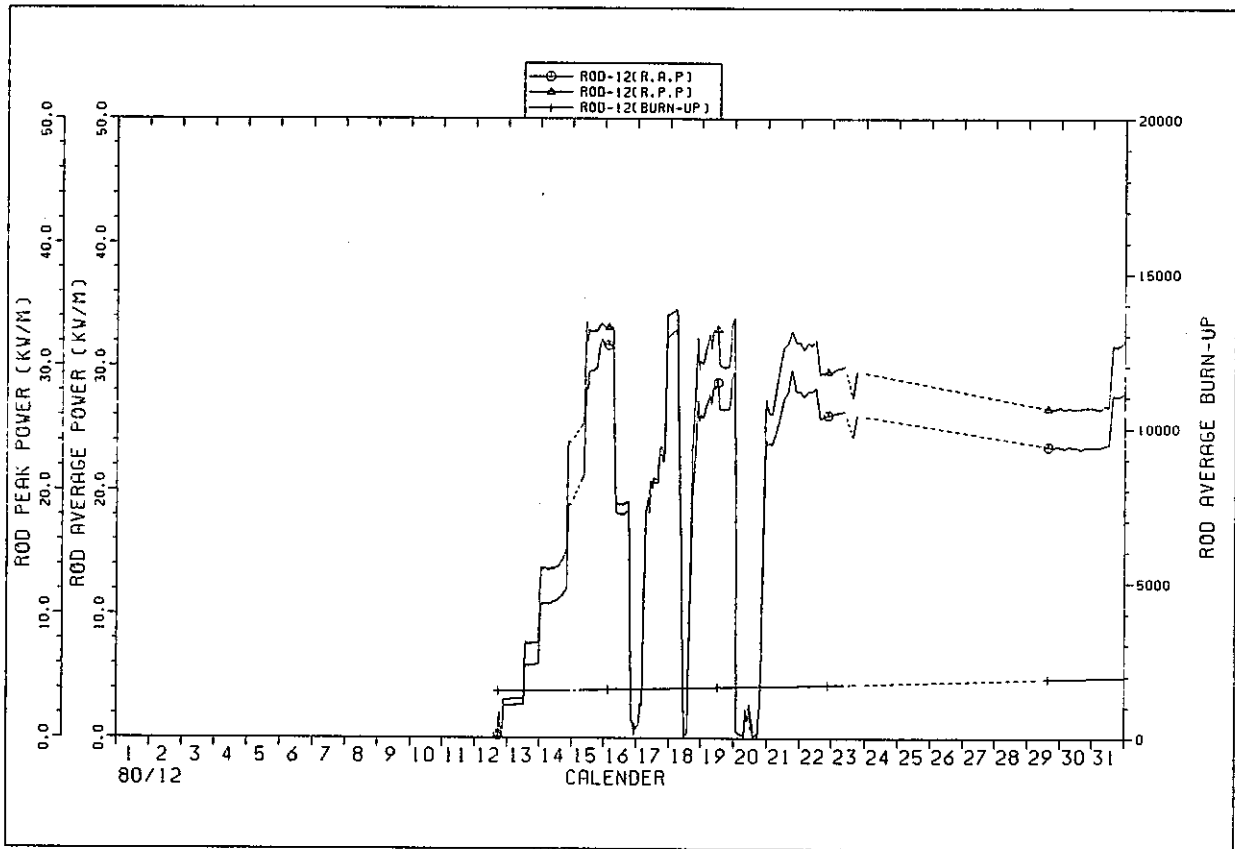

IFA529 ROD POWER HISTORY

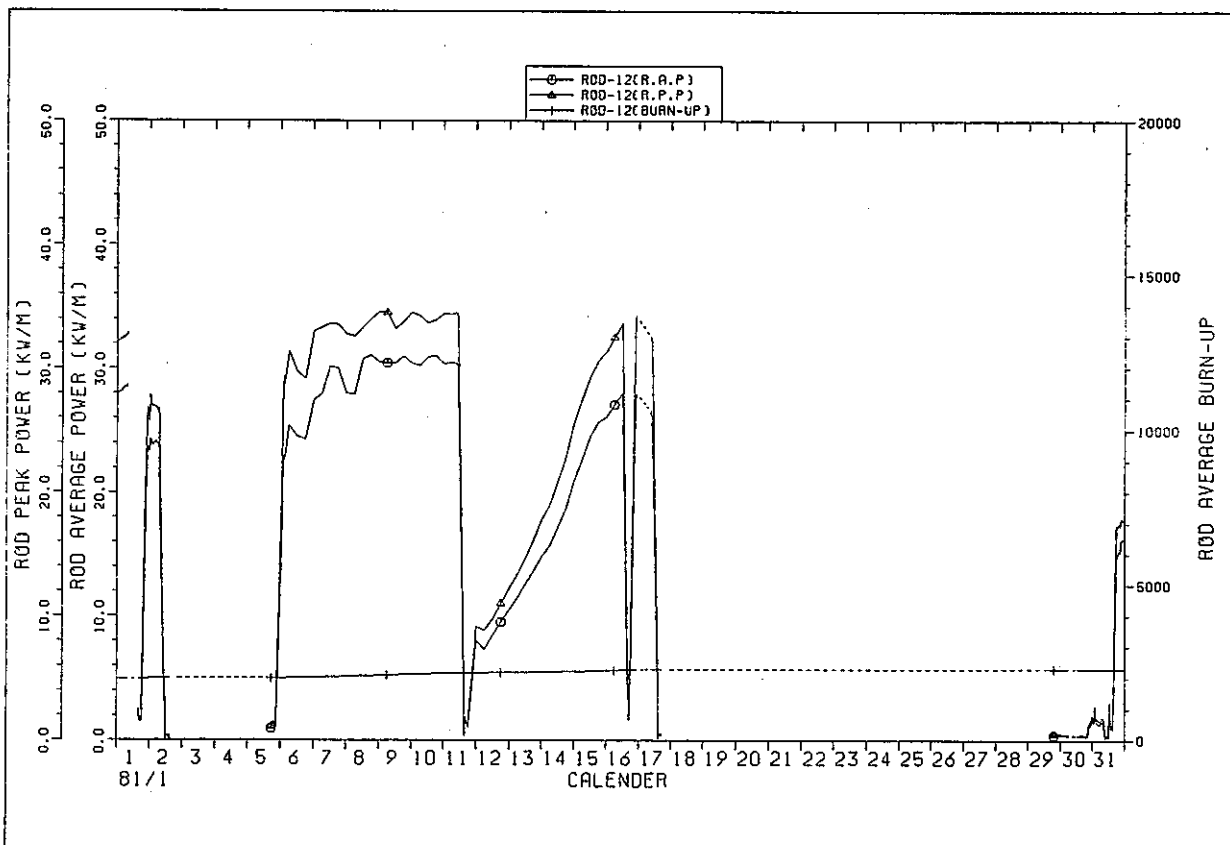

IFA529 ROD POWER HISTORY

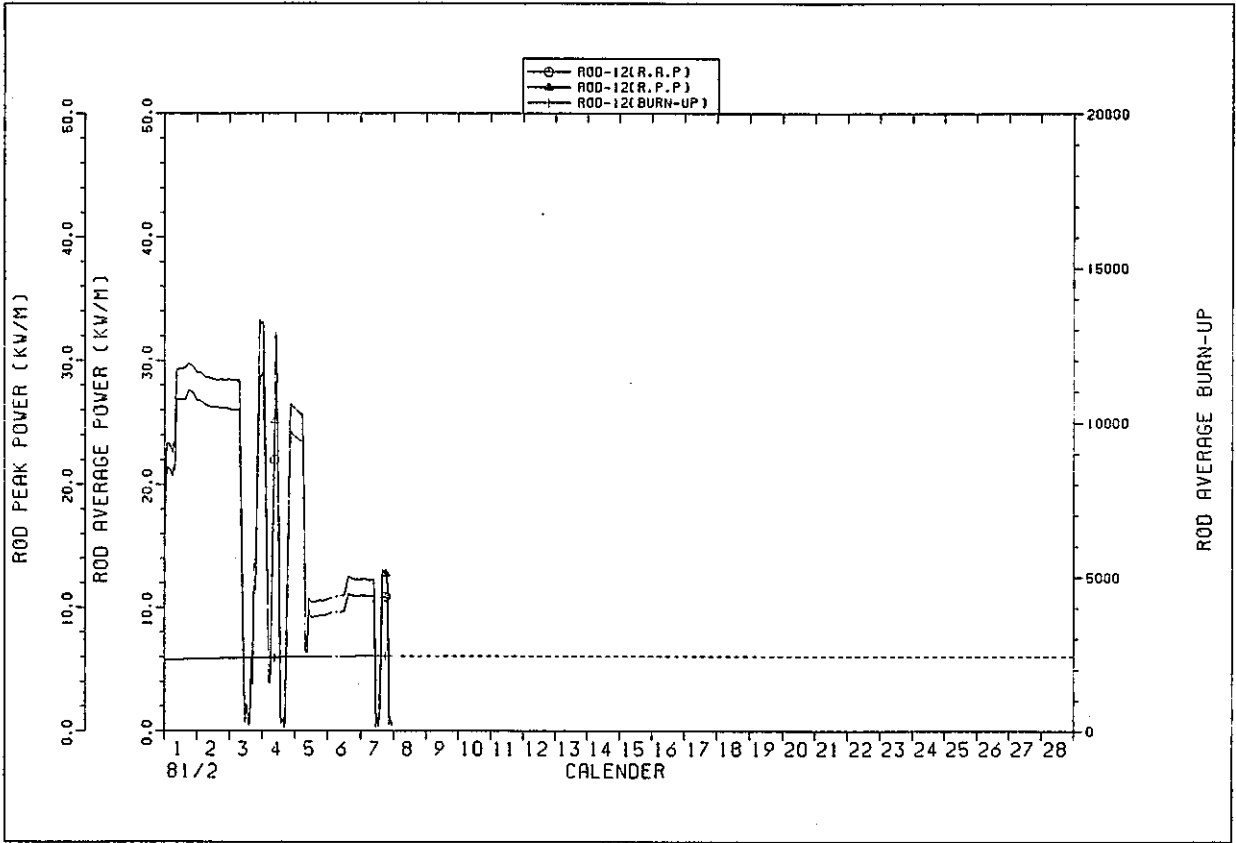

IFA529 ROD POWER HISTORY

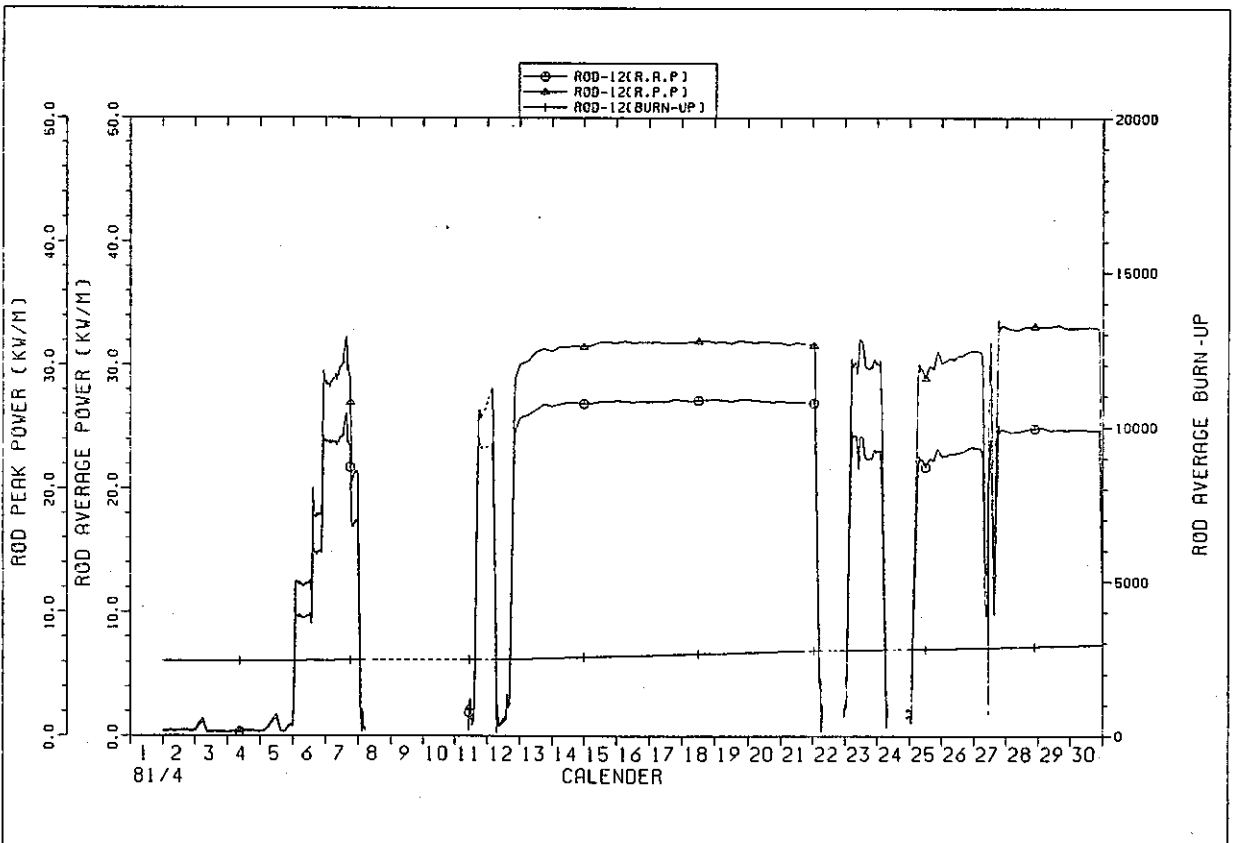

IFA529 ROD POWER HISTORY

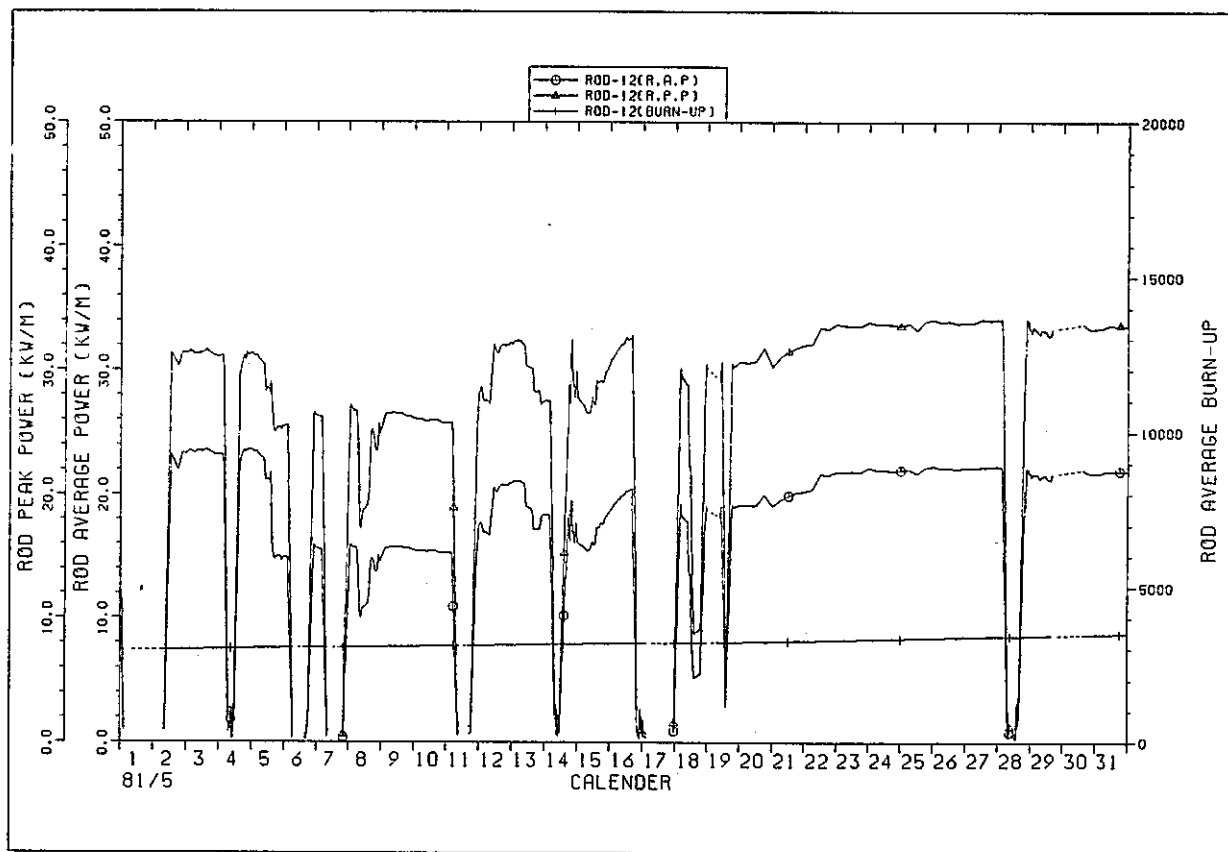

IFA529 ROD POWER HISTORY

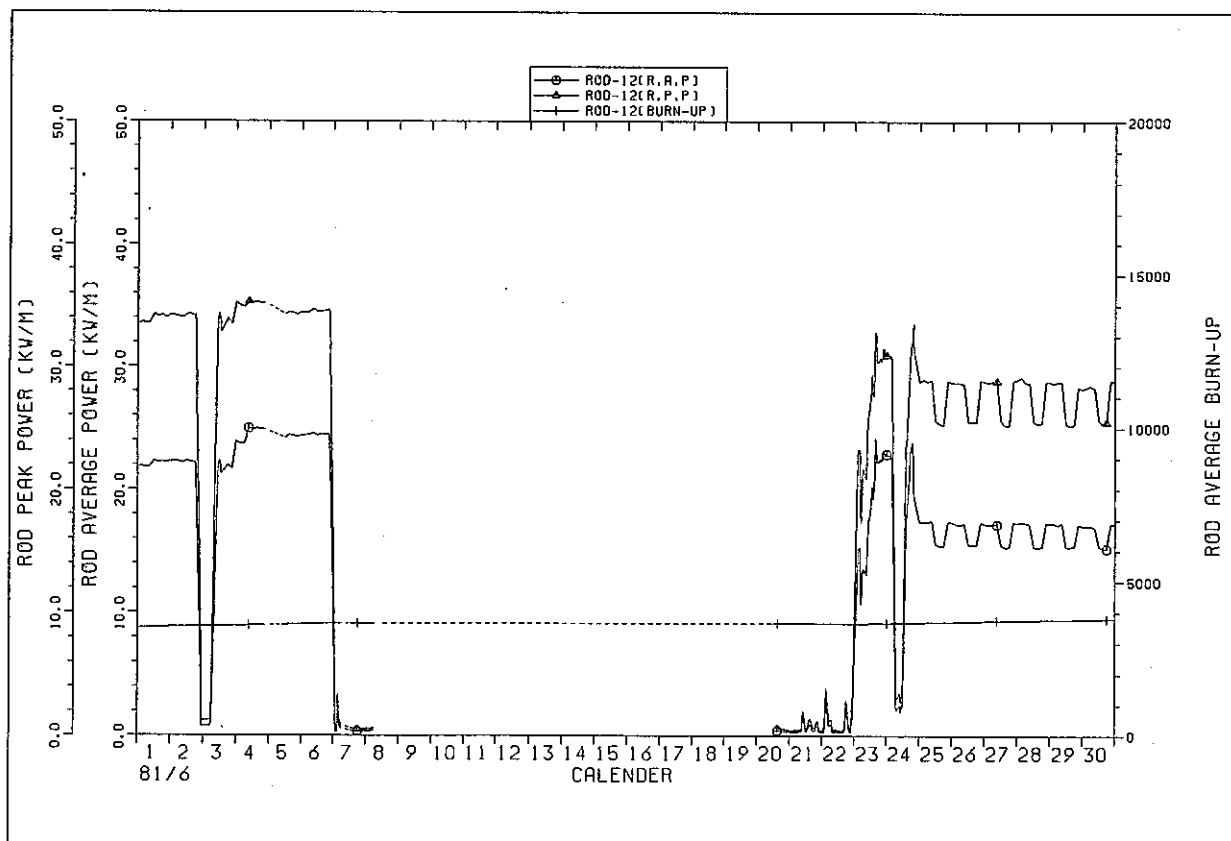

IFA529 ROD POWER HISTORY

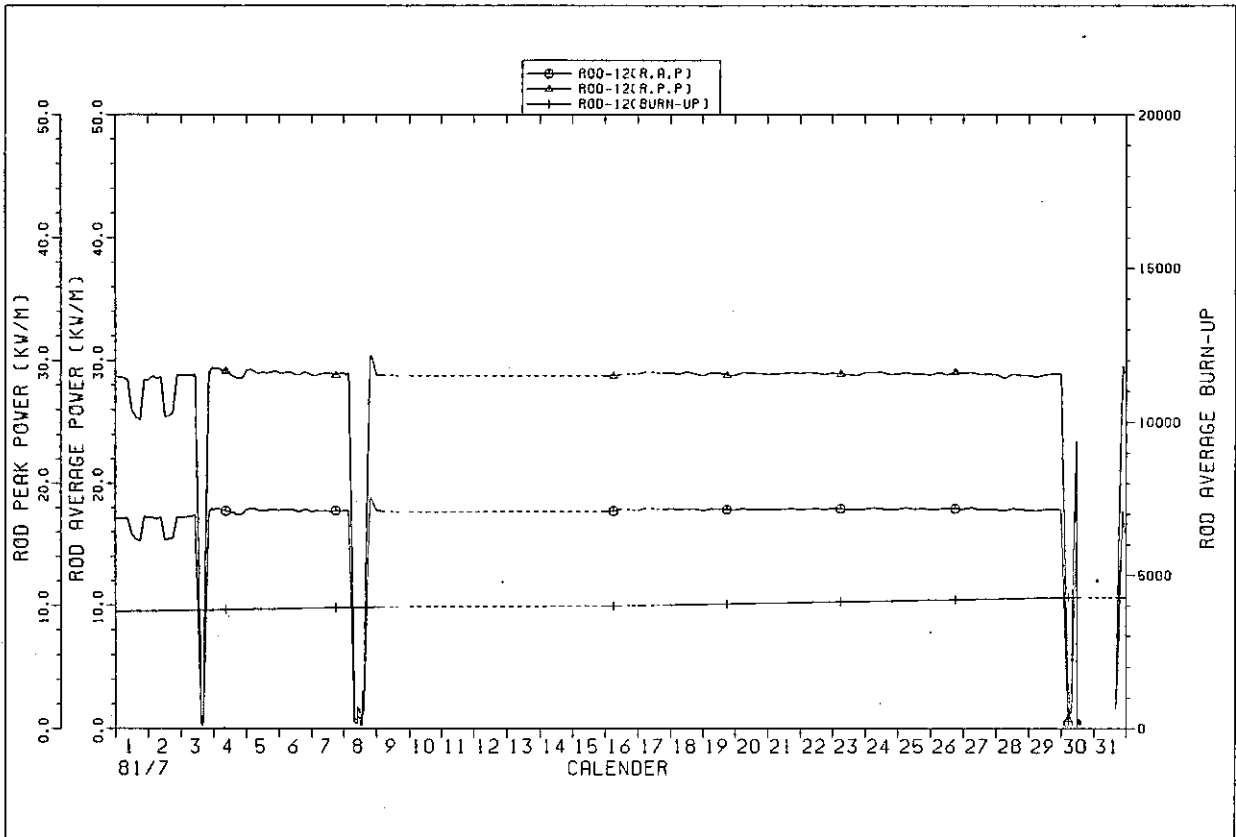

IFA529 ROD POWER HISTORY

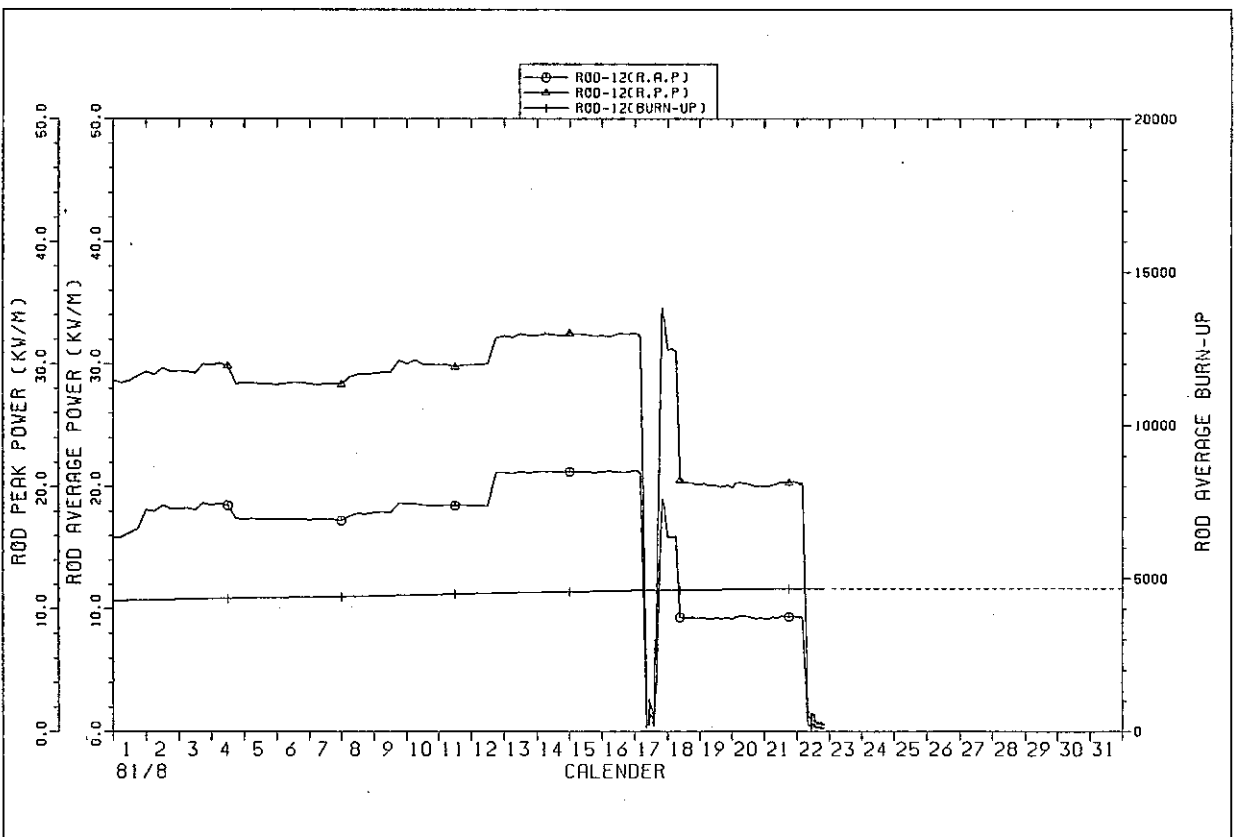

IFA529 ROD POWER HISTORY

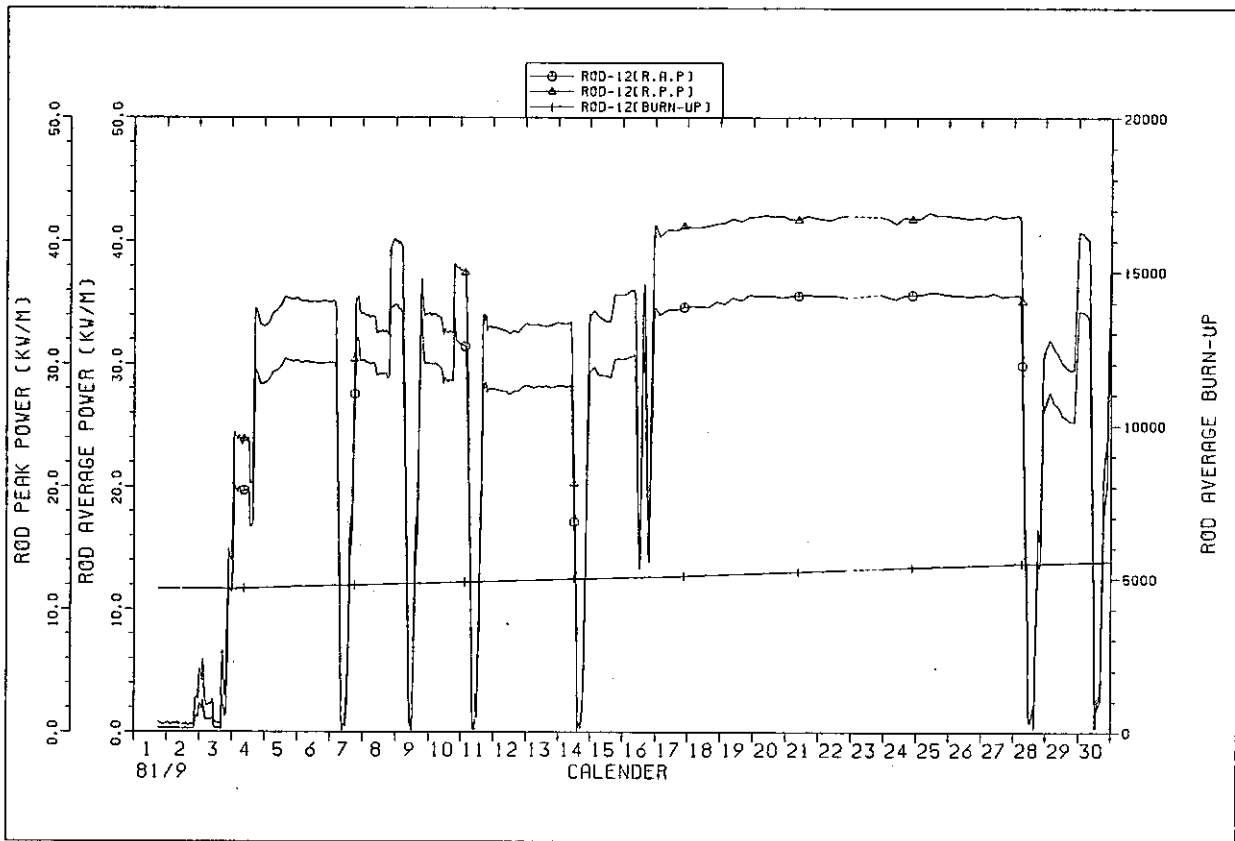

IFA529 ROD POWER HISTORY

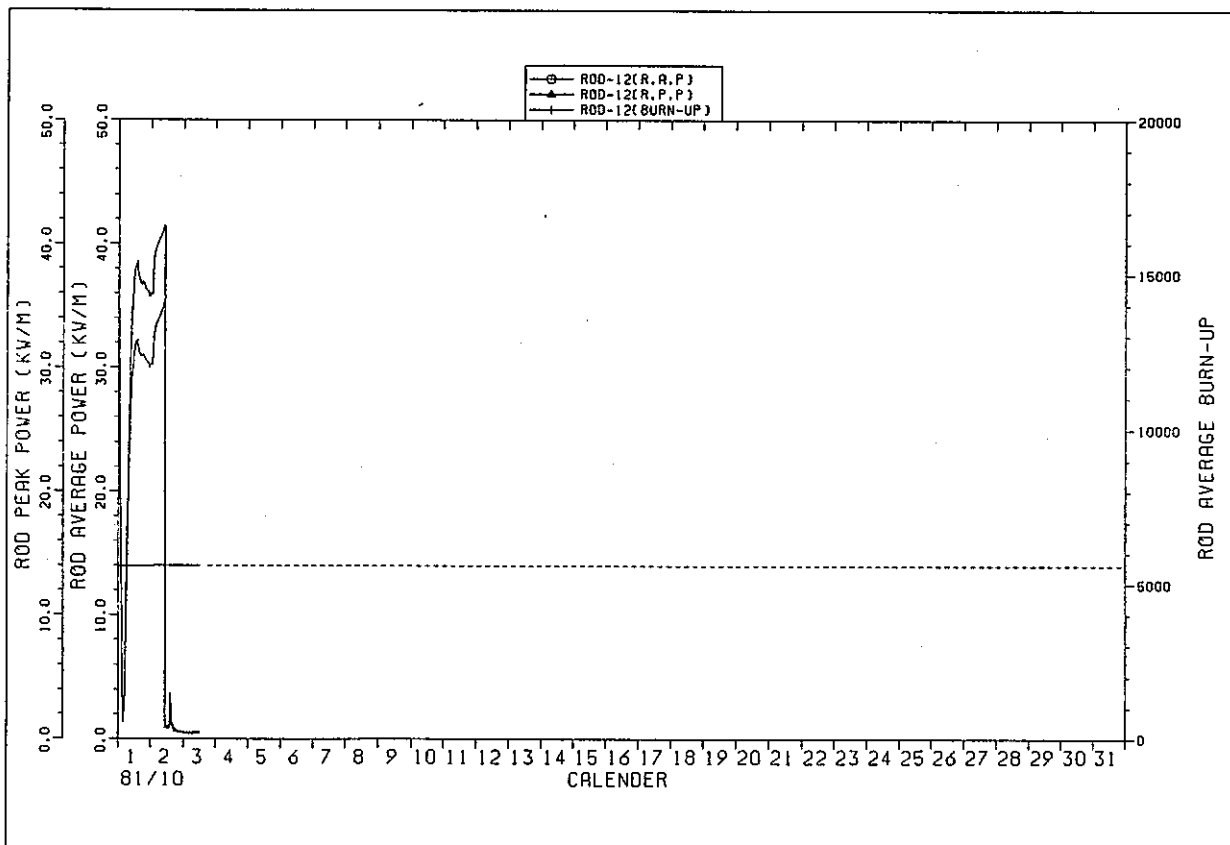

IFA529 ROD POWER HISTORY

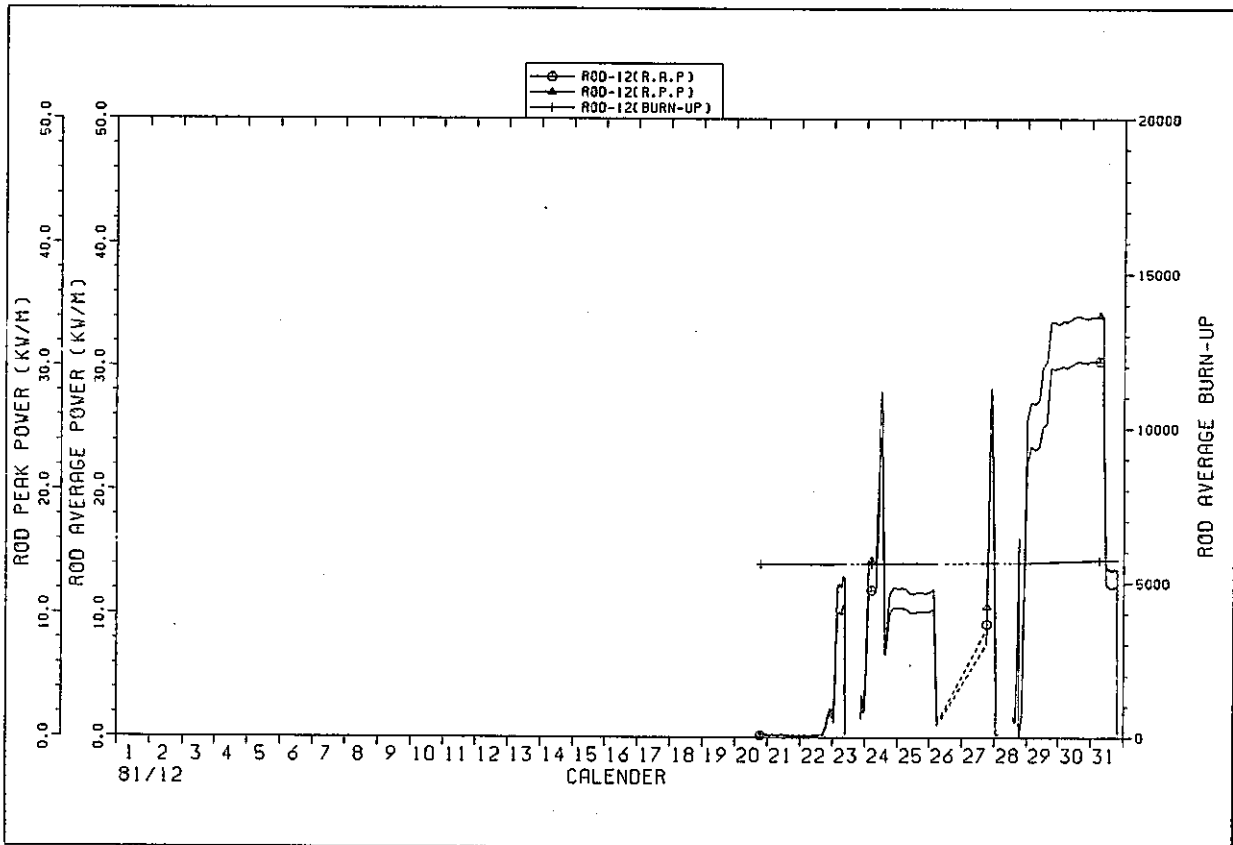

IFA529 ROD POWER HISTORY

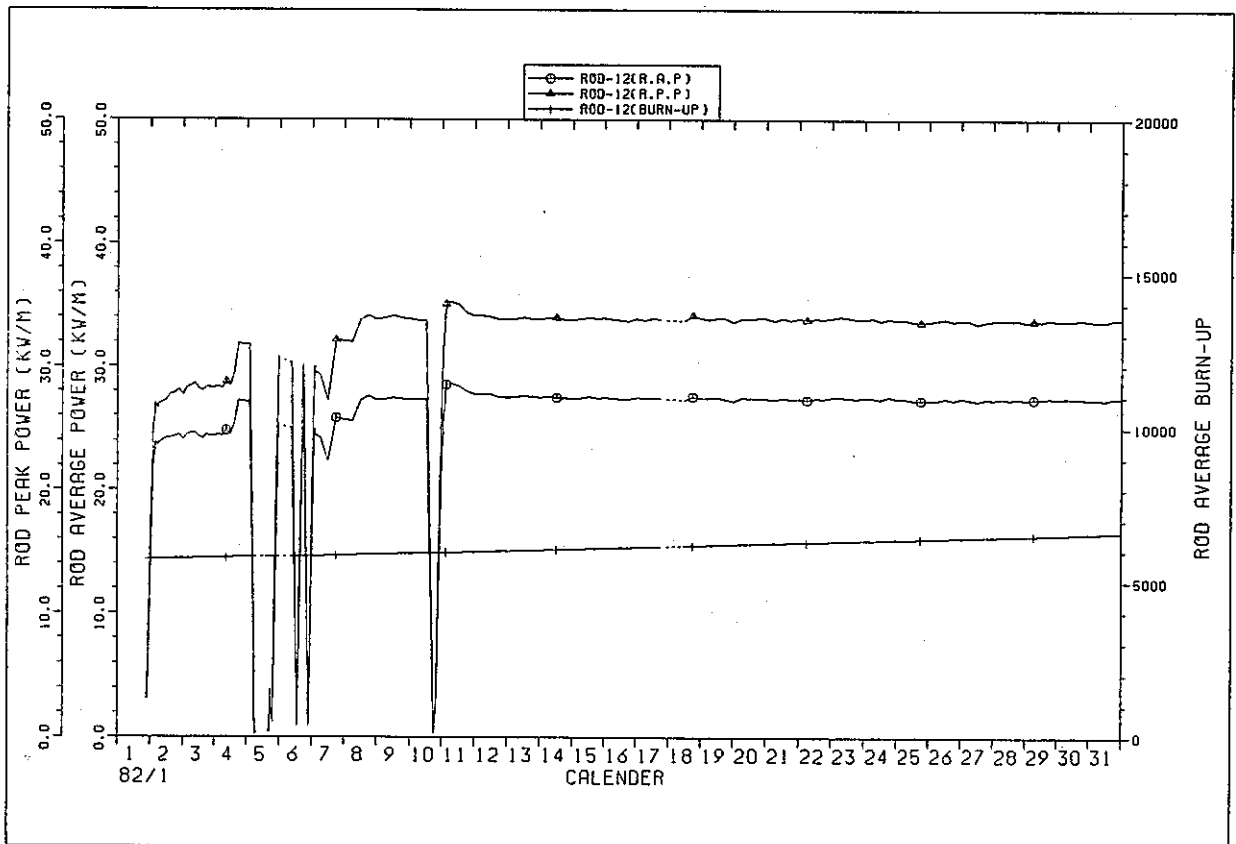

IFA529 ROD POWER HISTORY

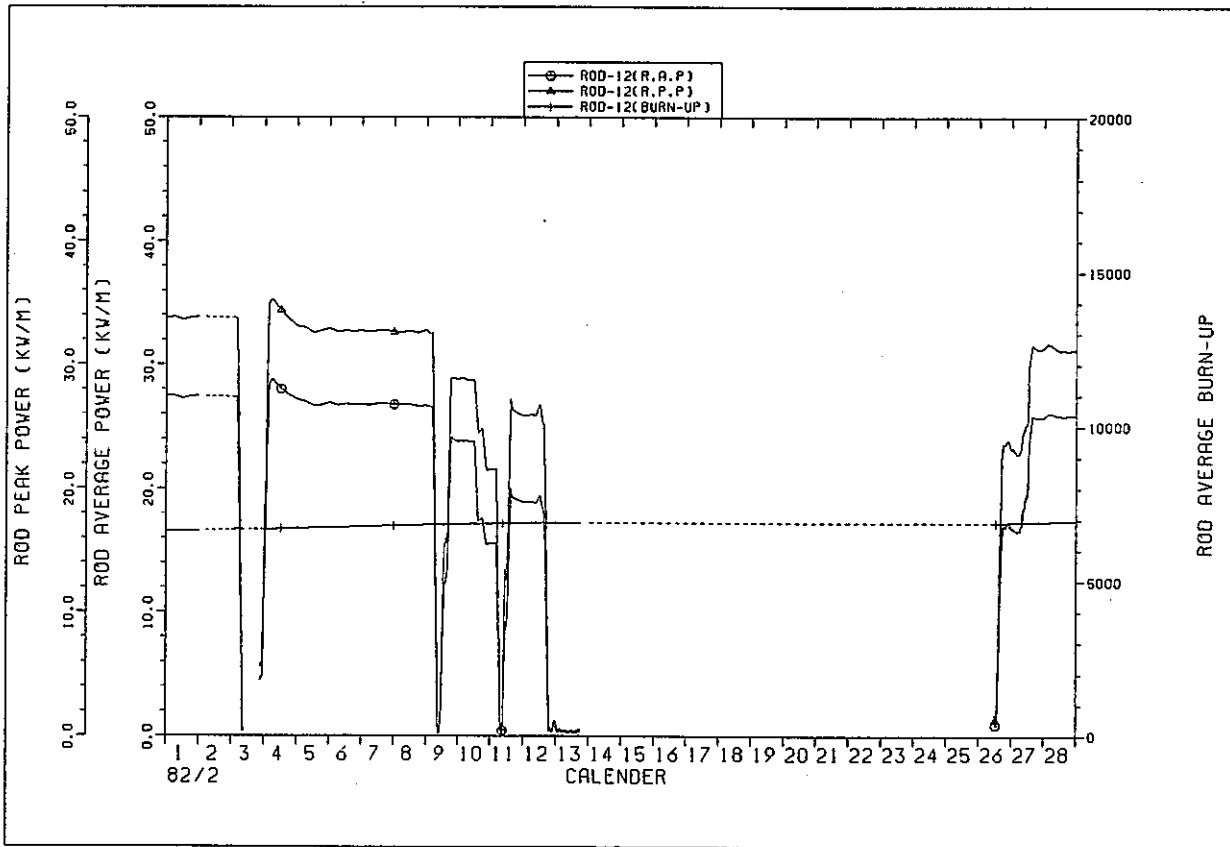

IFA529 ROD POWER HISTORY

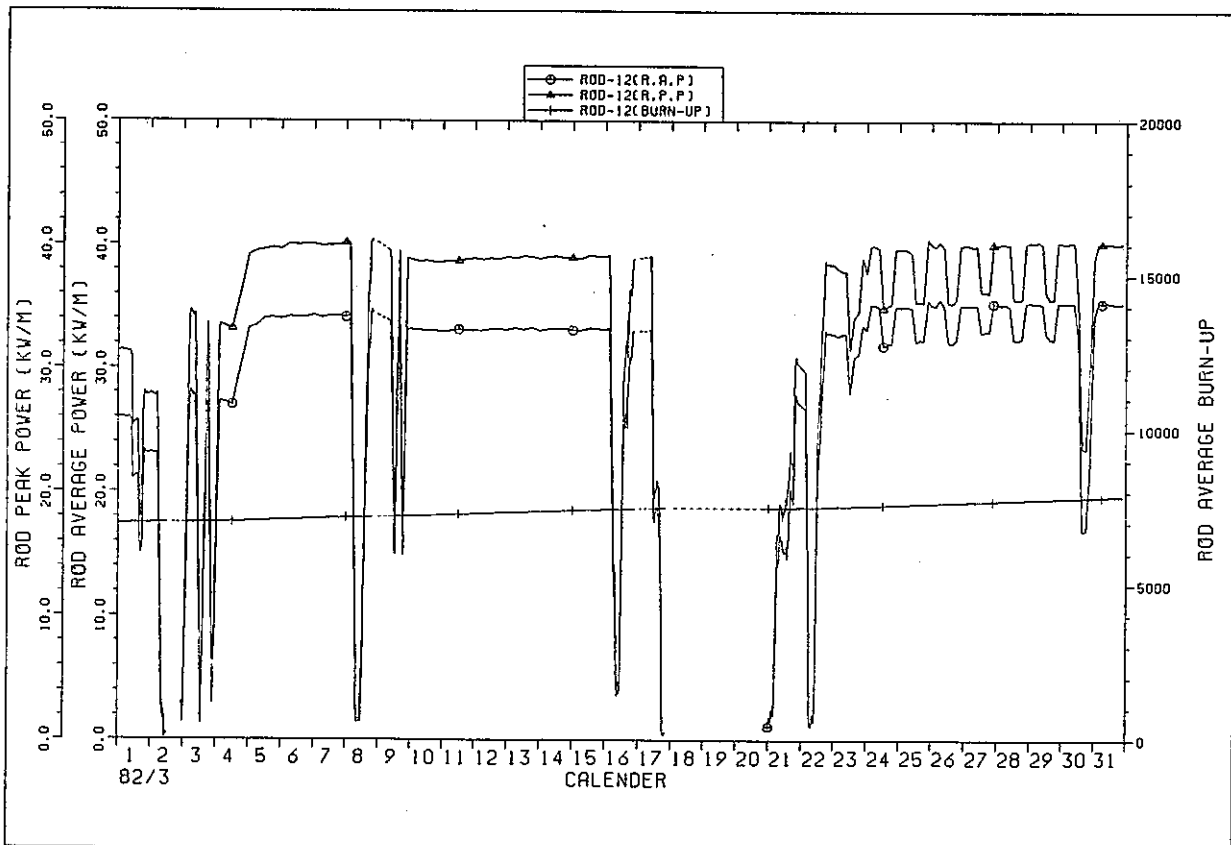

IFA529 ROD POWER HISTORY

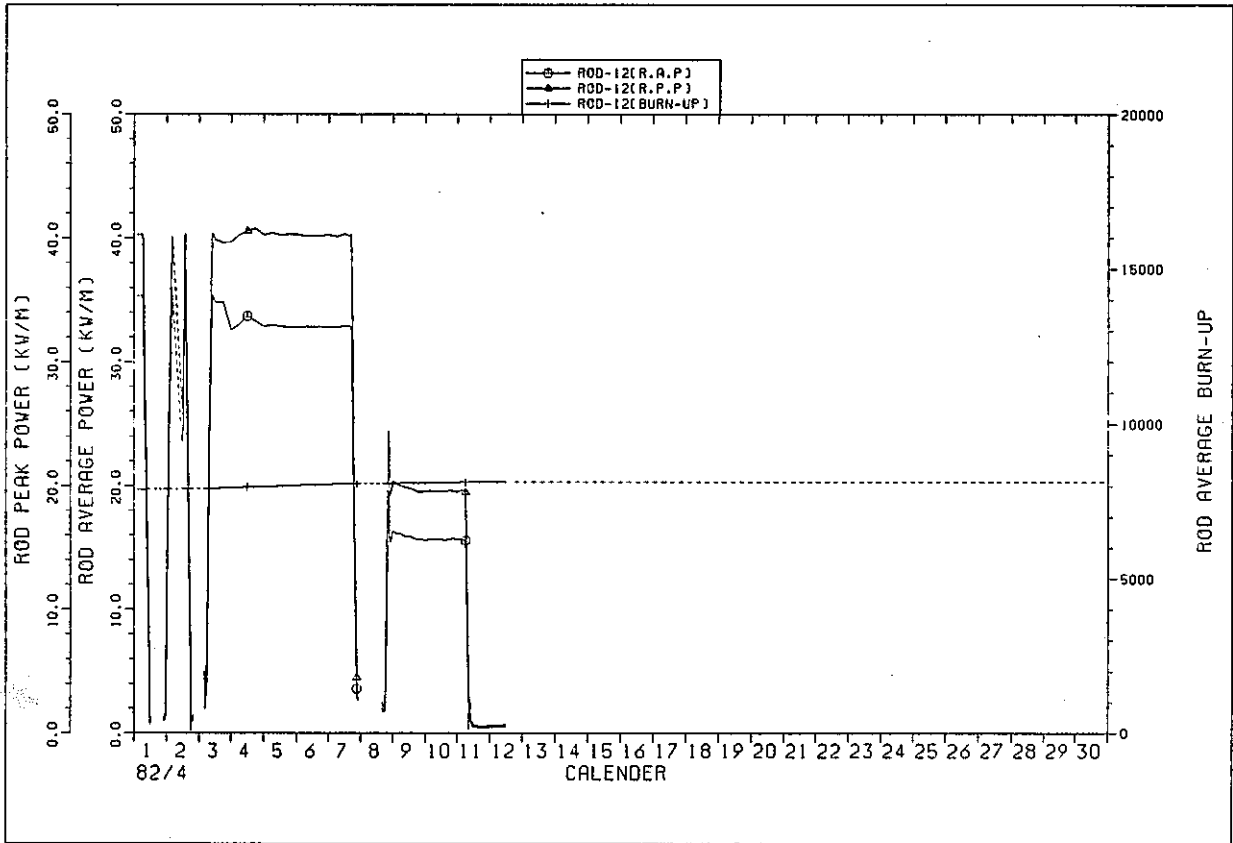

IFA529 ROD POWER HISTORY

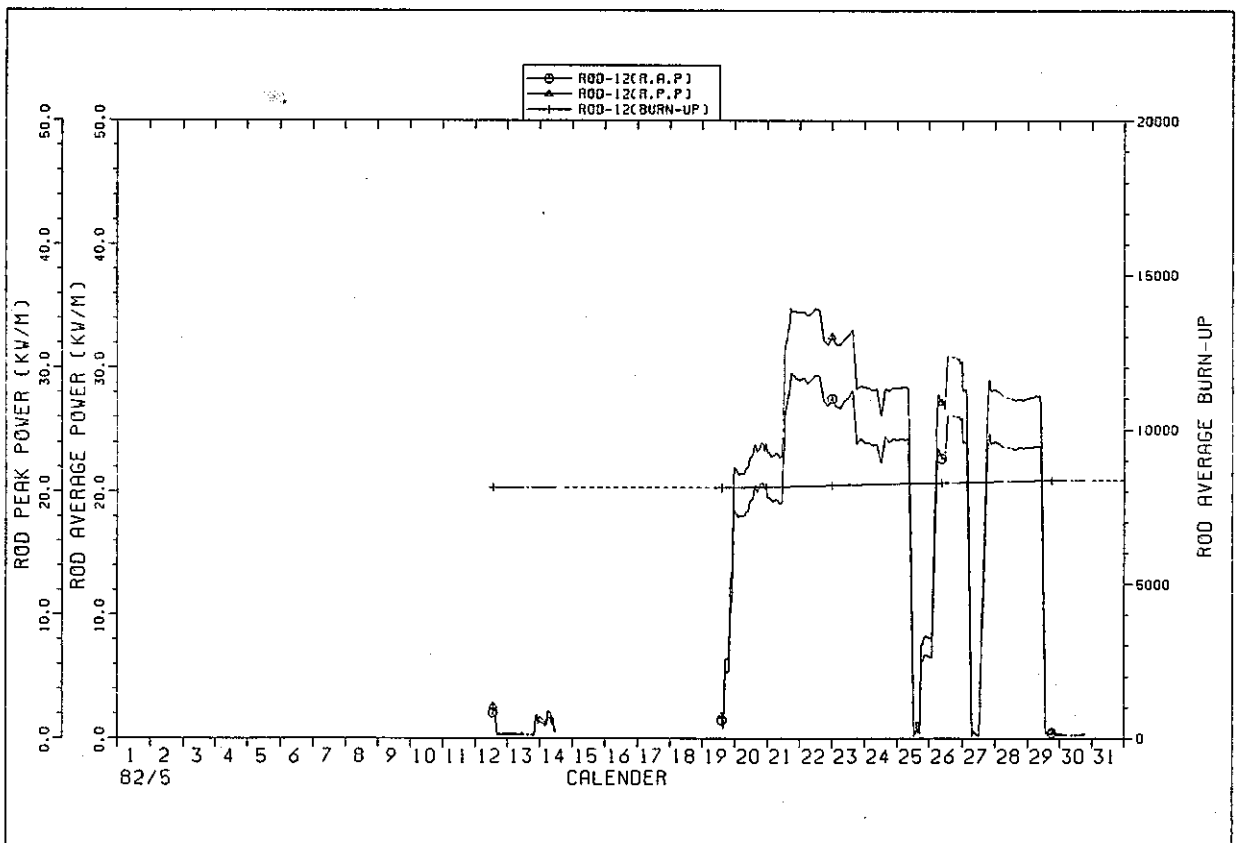

IFA529 ROD POWER HISTORY

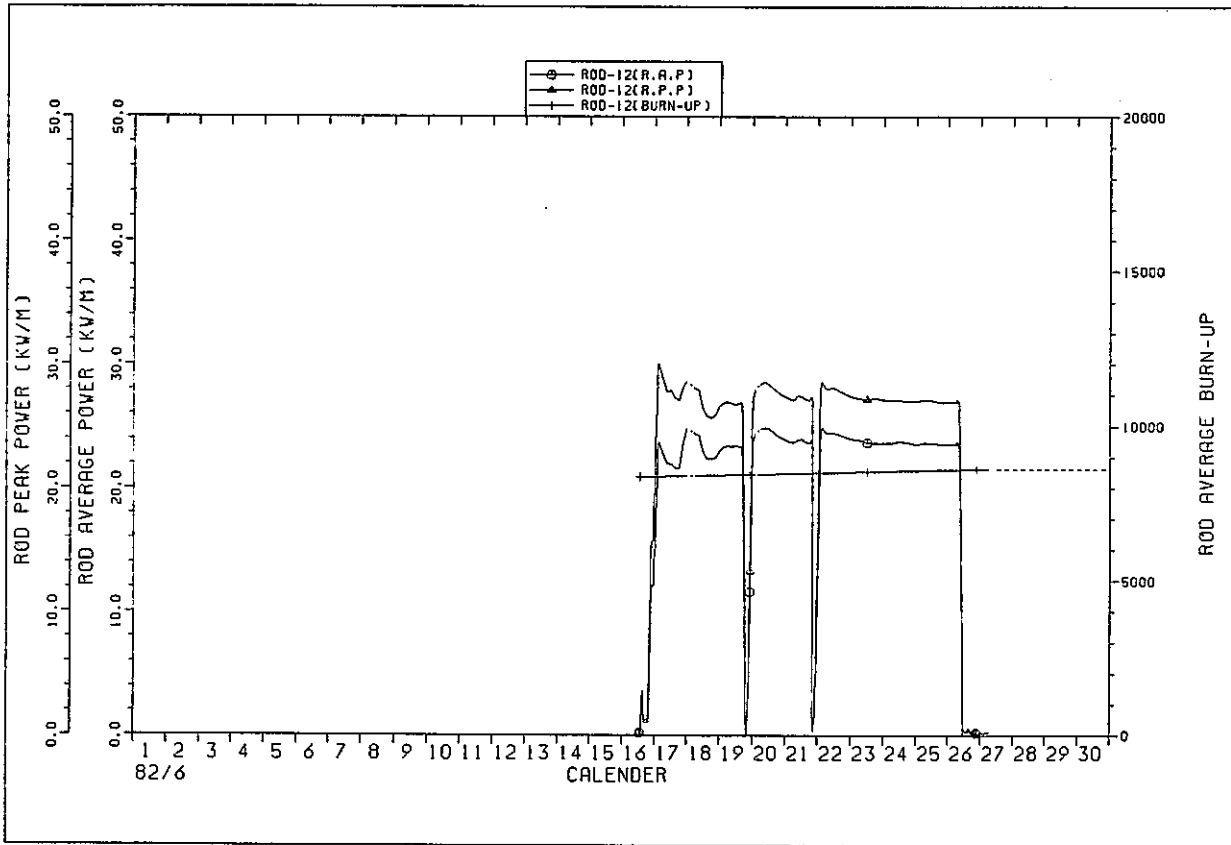

IFA529 ROD POWER HISTORY

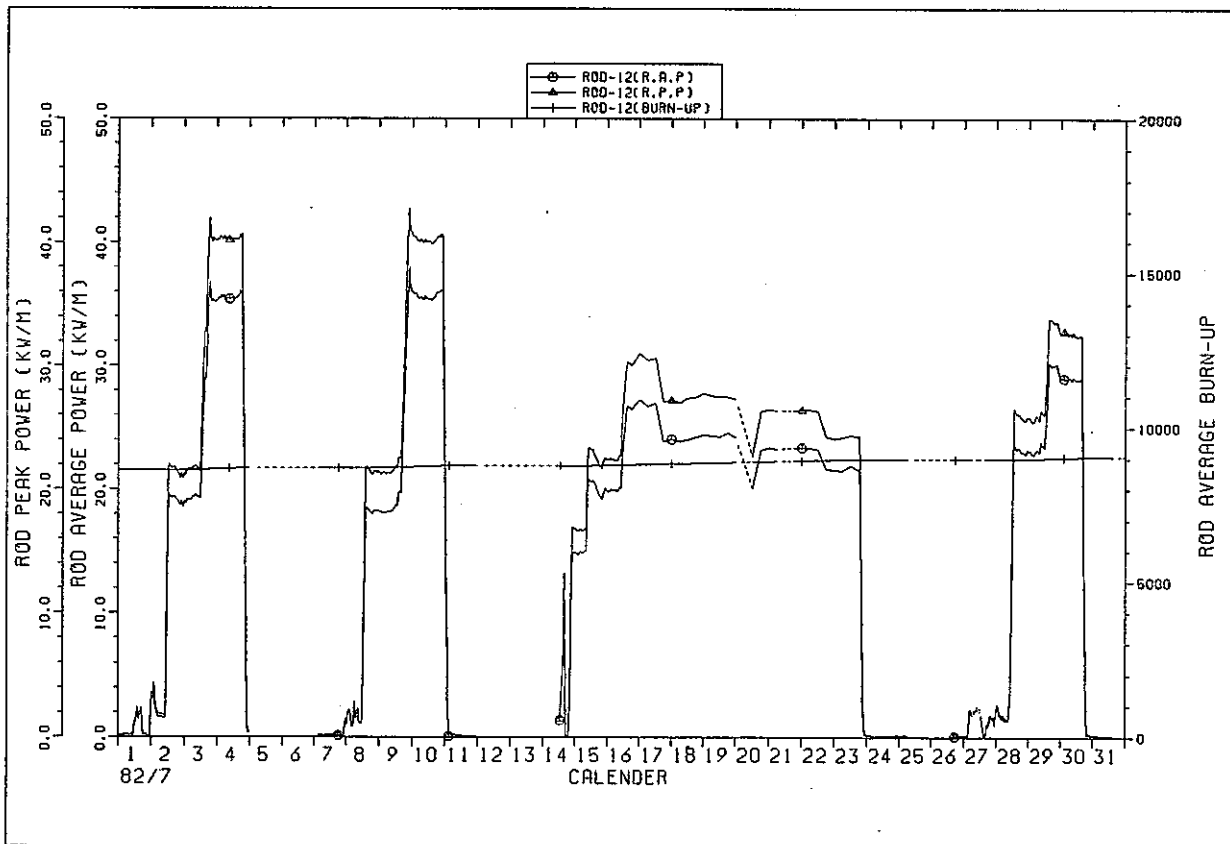

IFA529 ROD POWER HISTORY

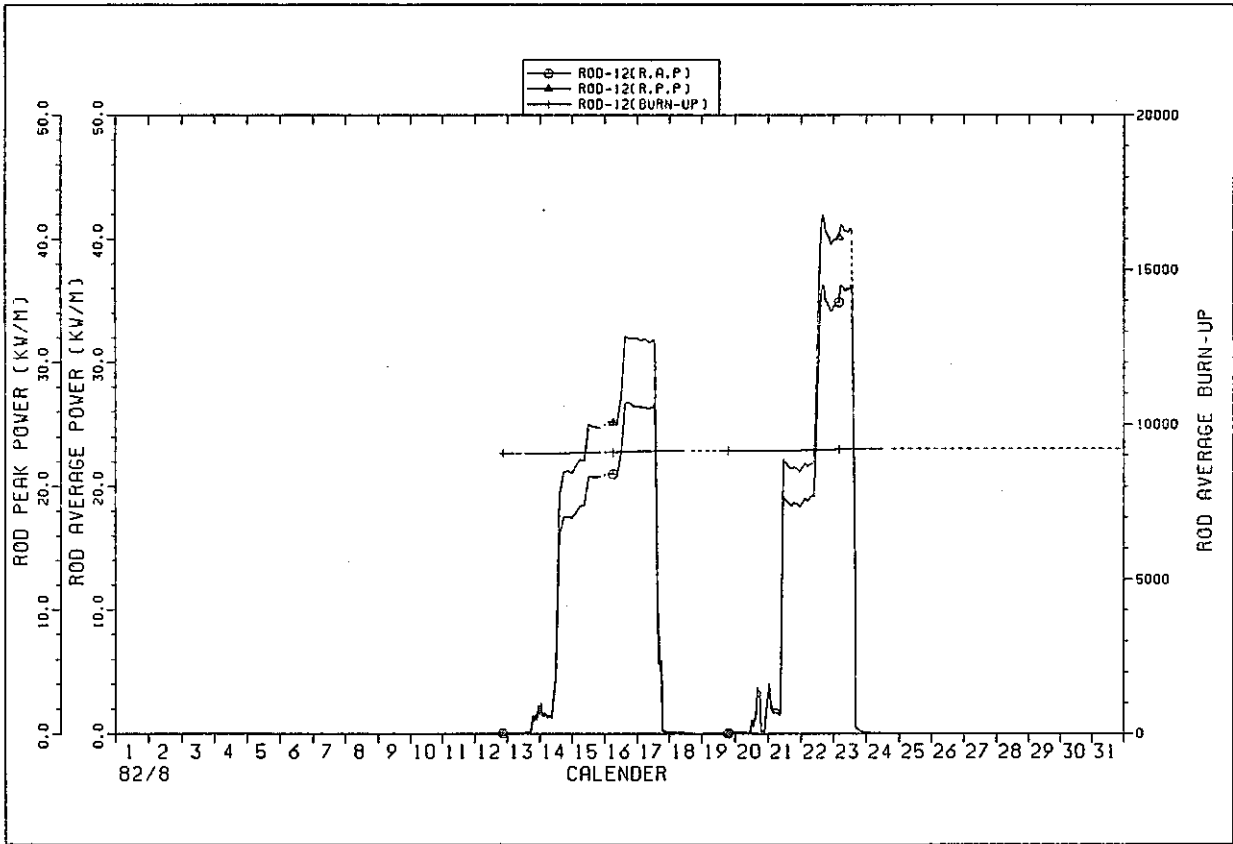

IFA529 ROD POWER HISTORY

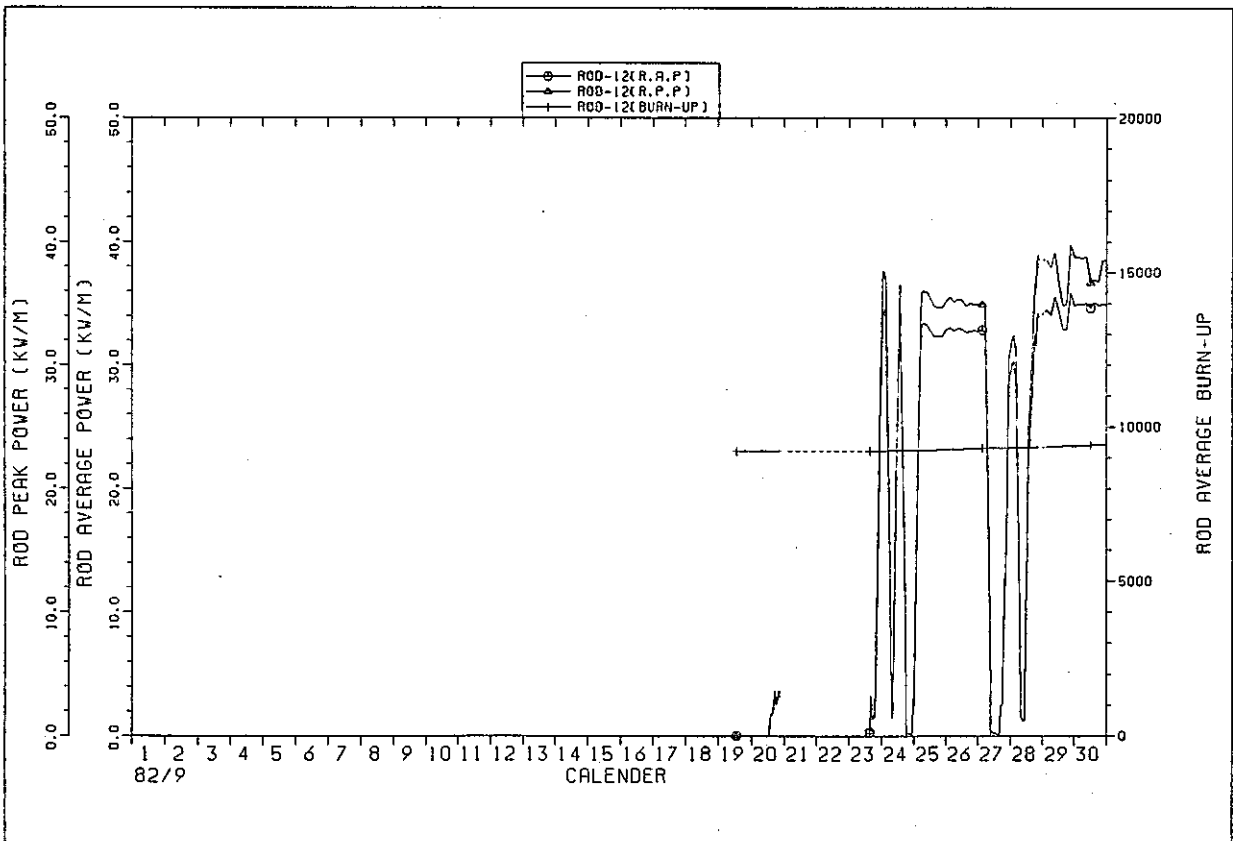

IFA529 ROD POWER HISTORY

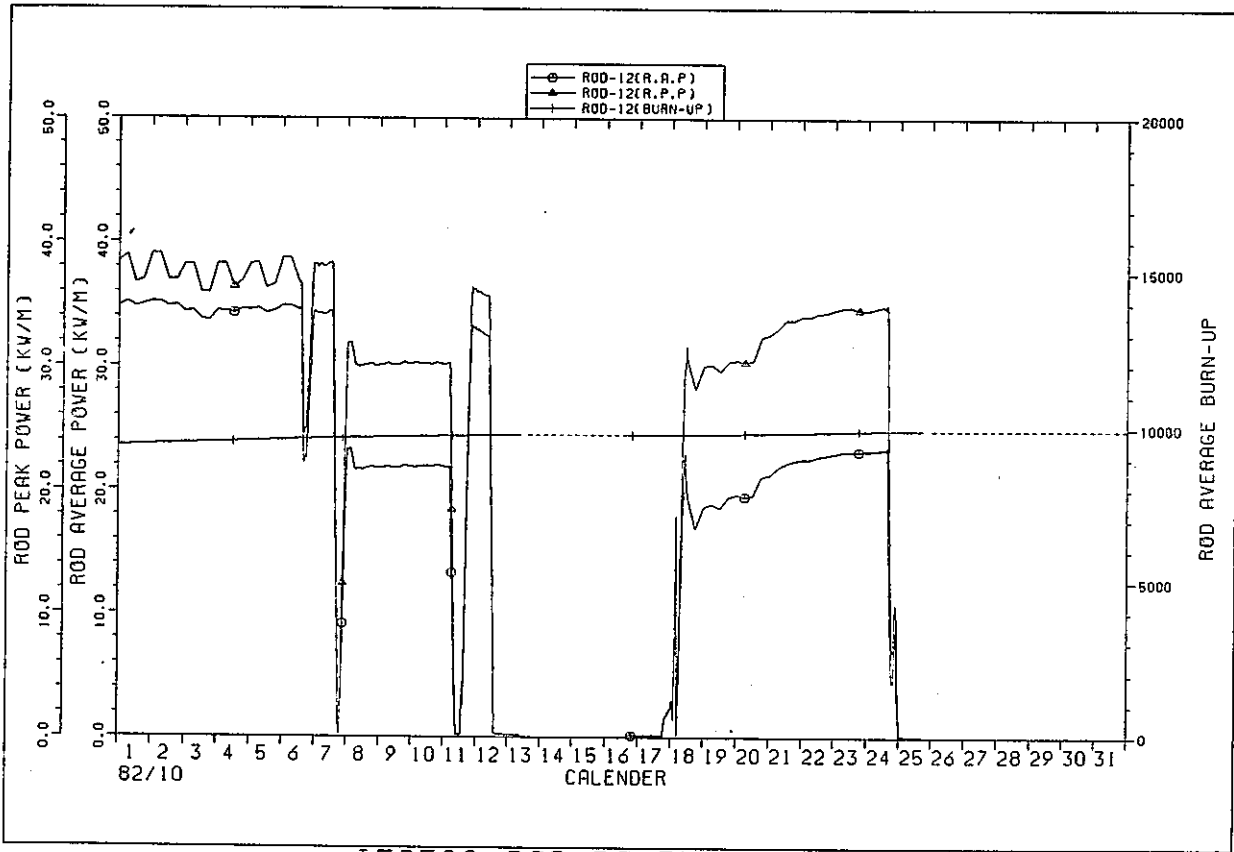

IFA529 ROD POWER HISTORY

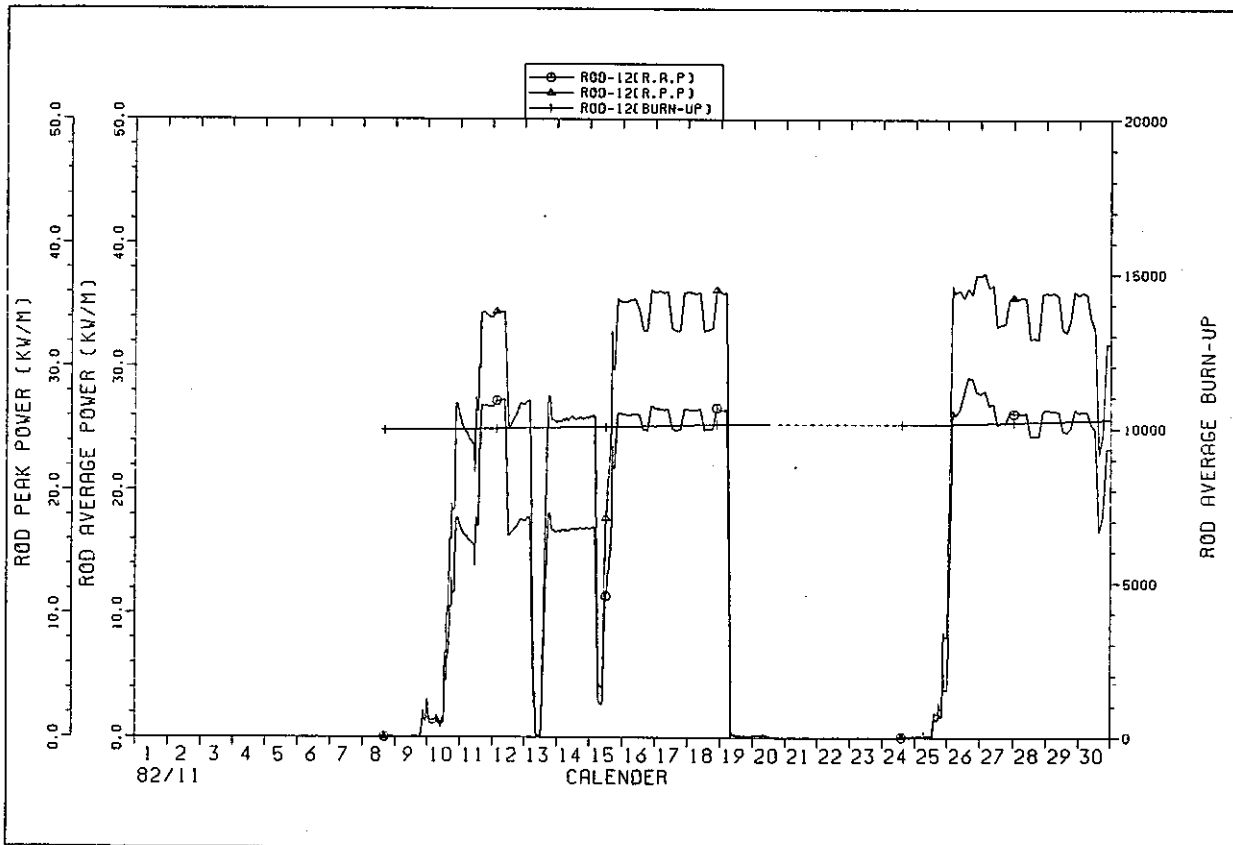

IFA529 ROD POWER HISTORY

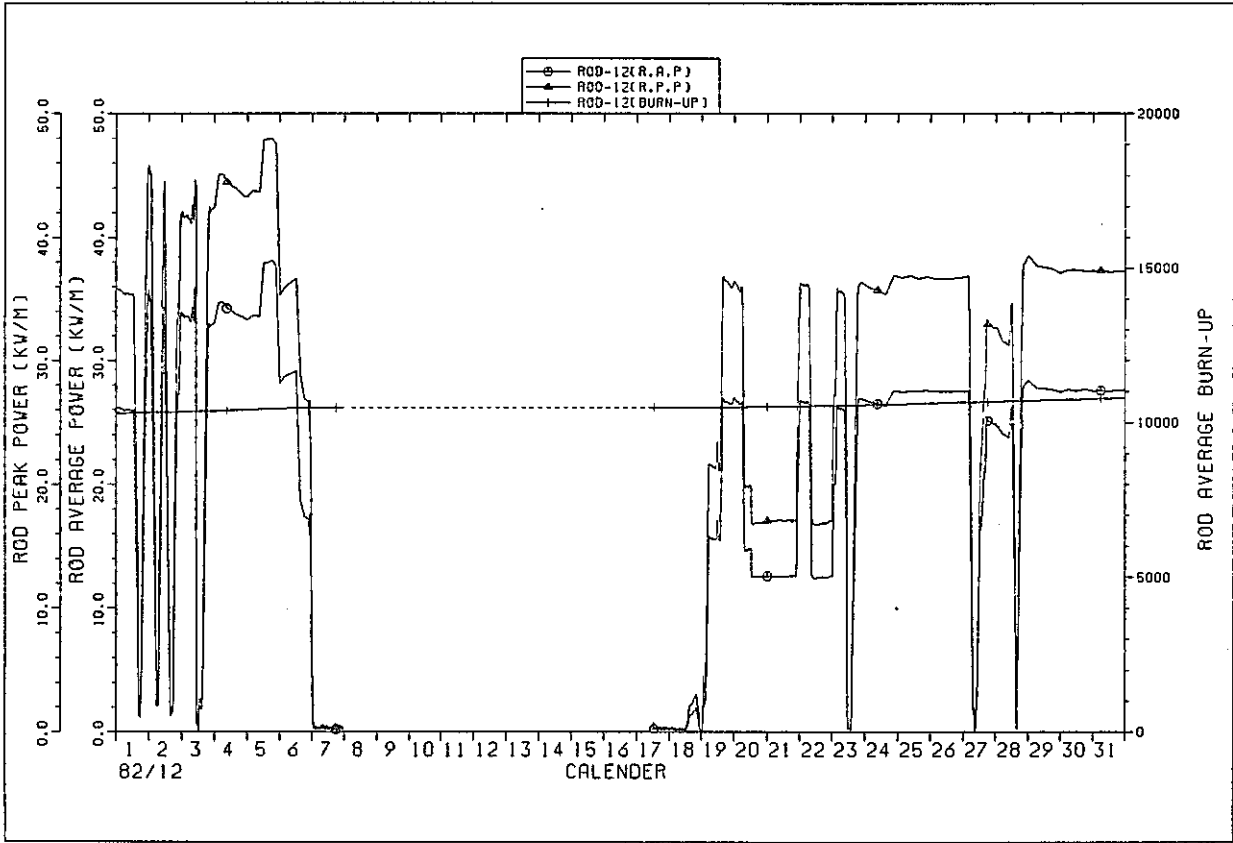

IFA529 ROD POWER HISTORY

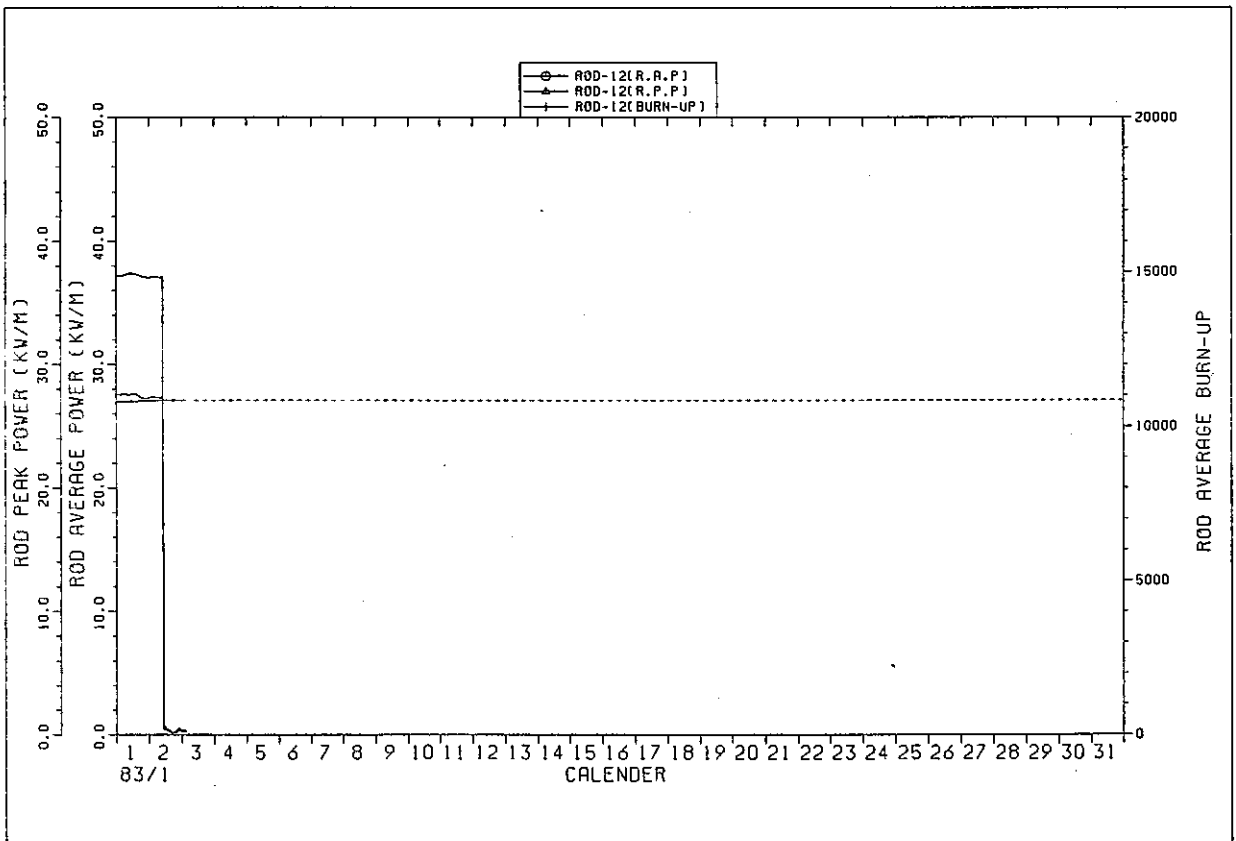

IFA529 ROD POWER HISTORY

付 録 3

I F A - 529 の 軸 方 向 出 力 分 布

(1980年7月～1983年1月)

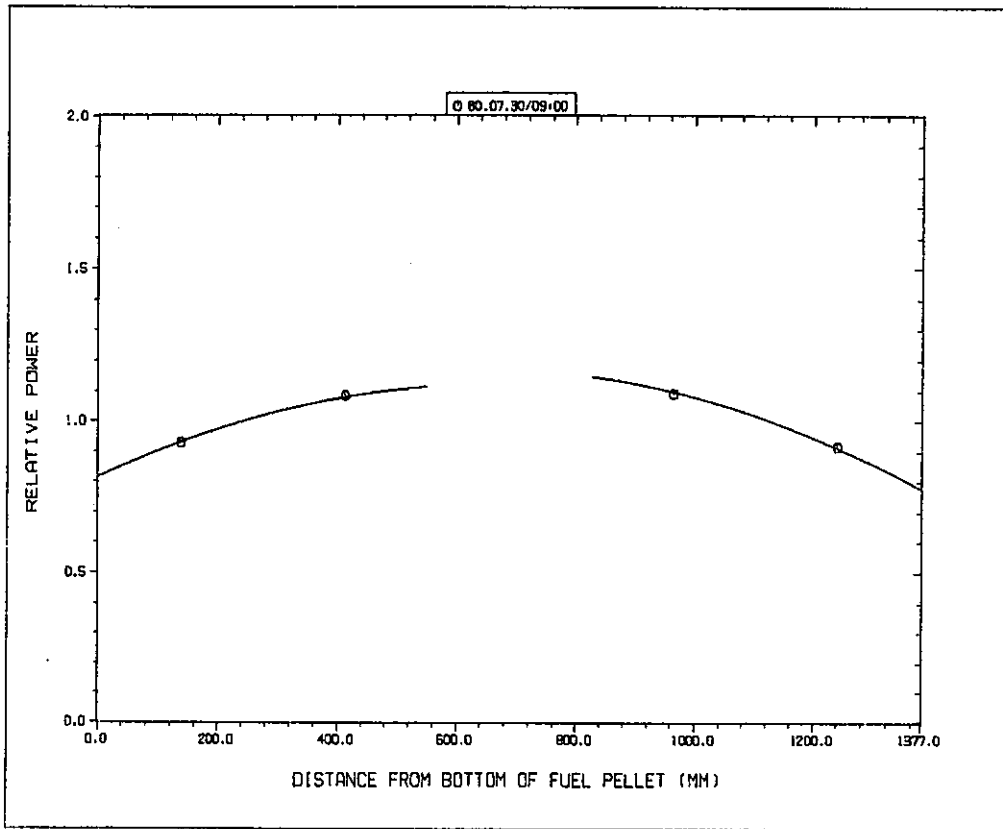

IFA529 AXIAL POWER PROFILE

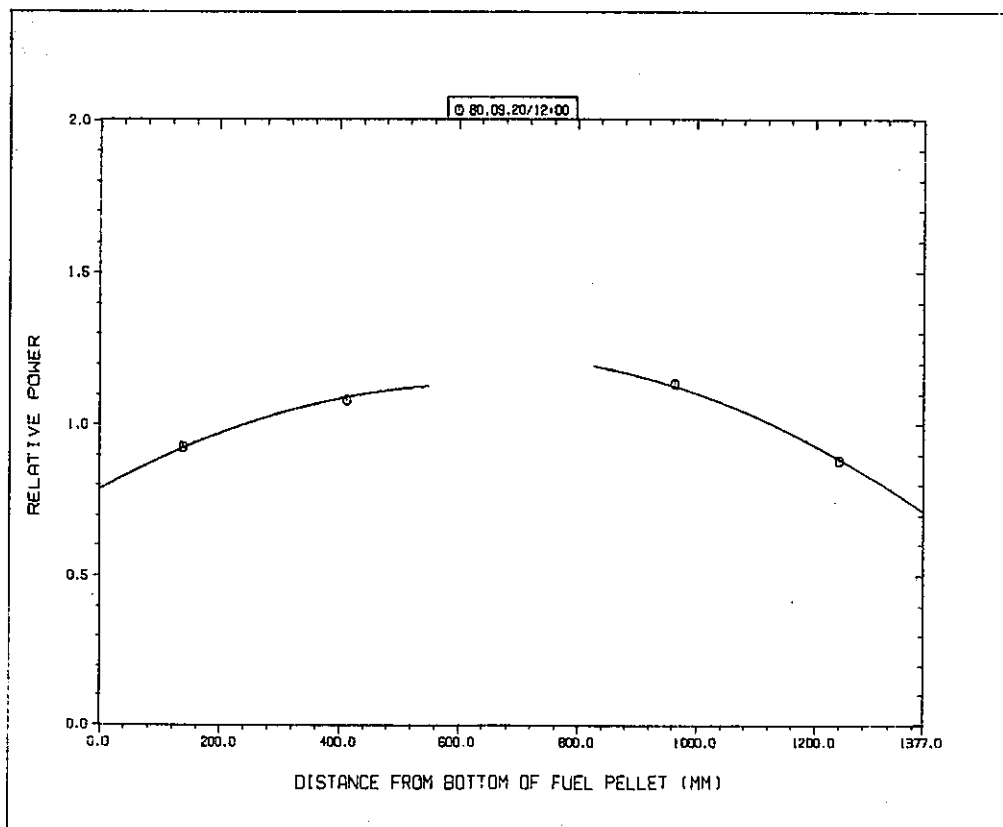

IFA529 AXIAL POWER PROFILE

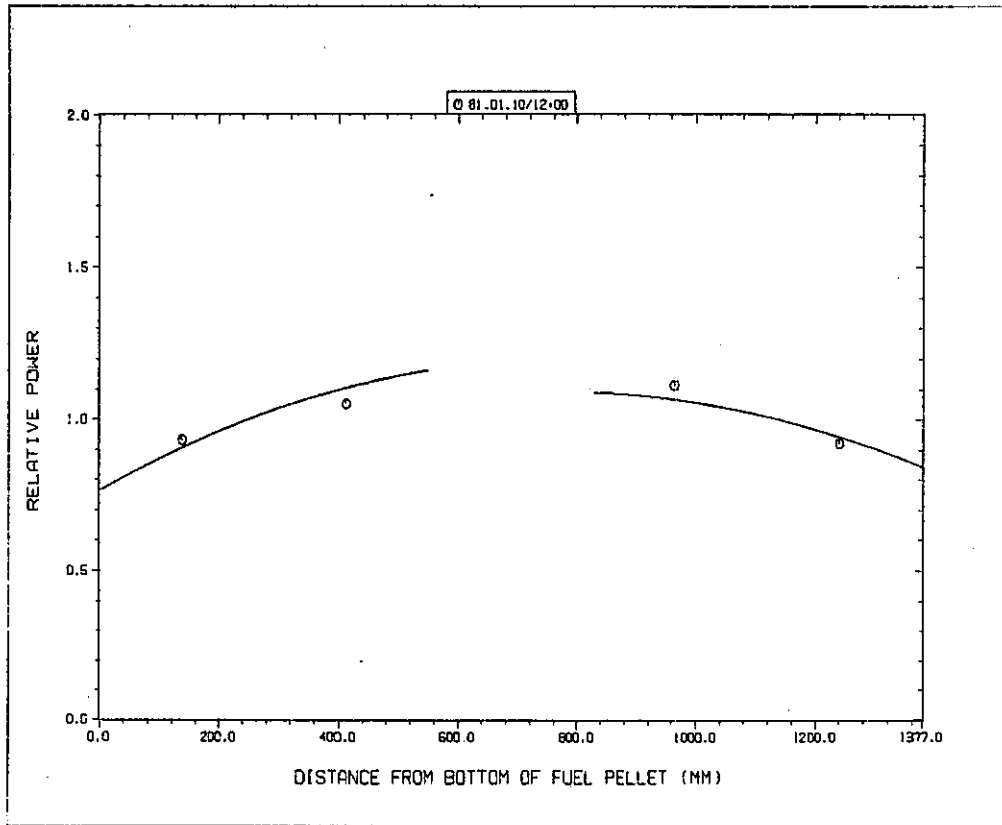

IFAS29 AXIAL POWER PROFILE

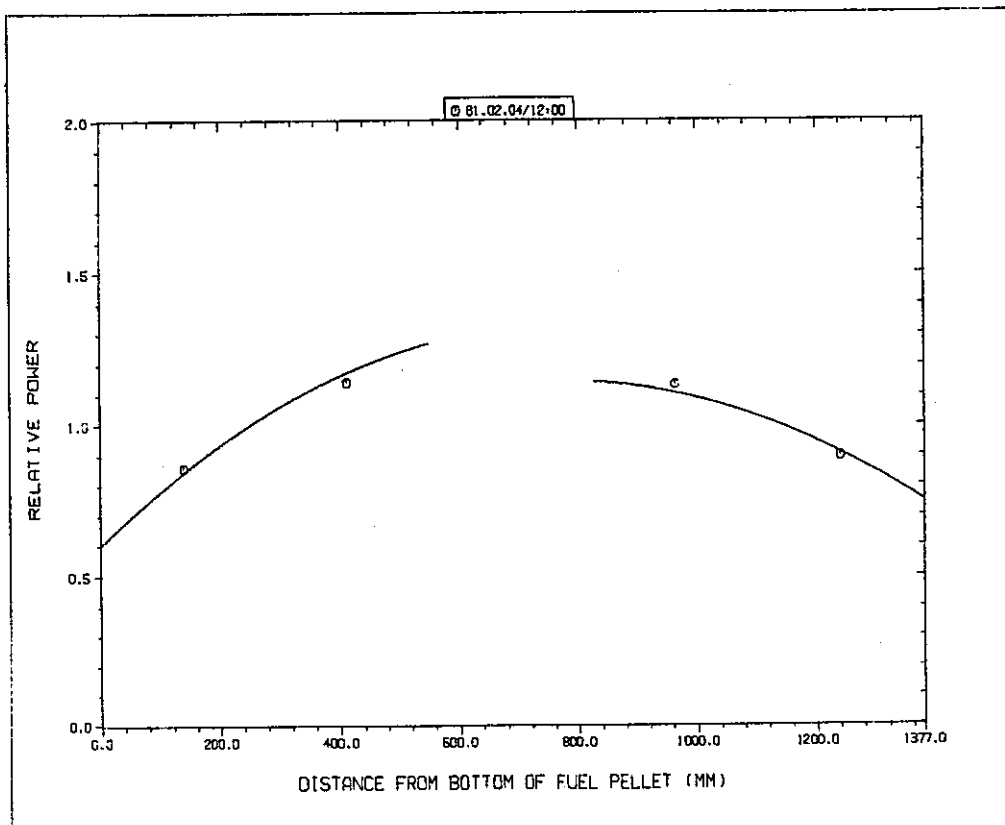

IFAS29 AXIAL POWER PROFILE

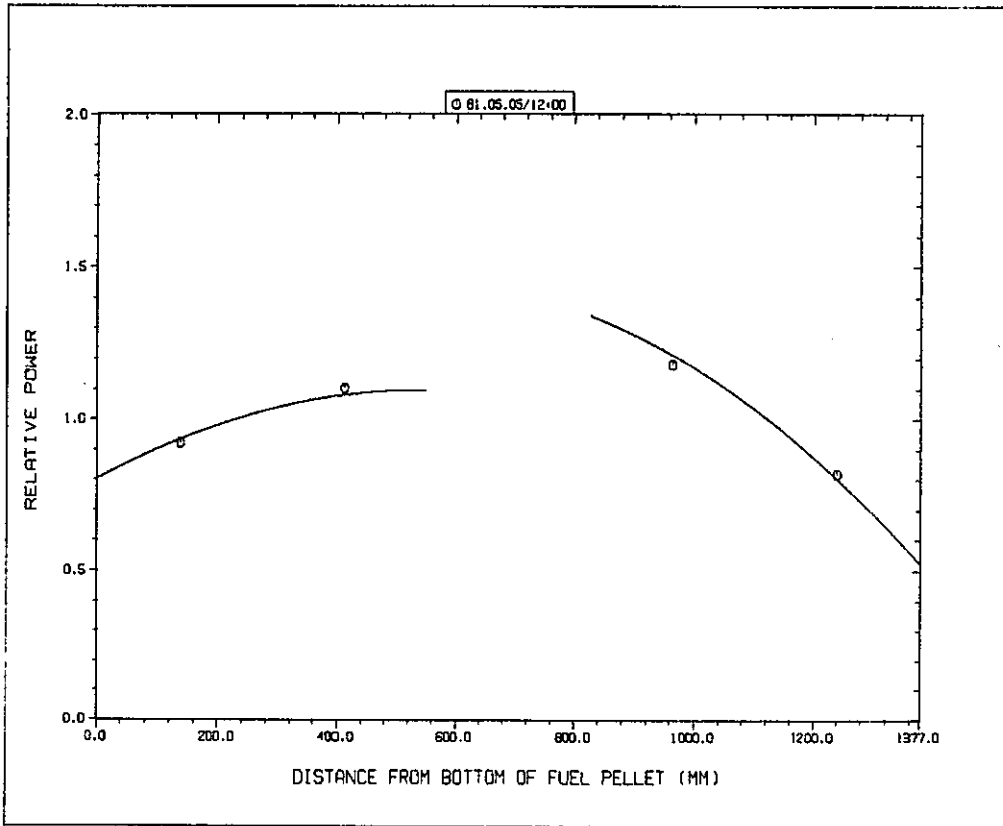

IFA529 AXIAL POWER PROFILE

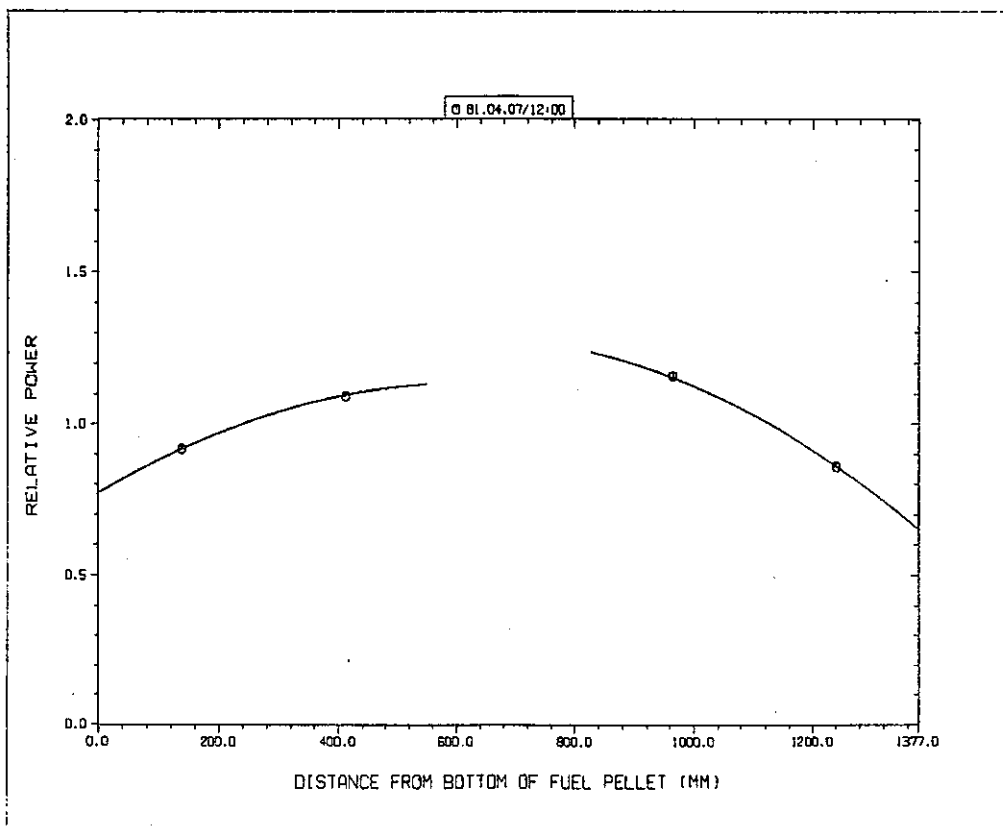

IFA529 AXIAL POWER PROFILE

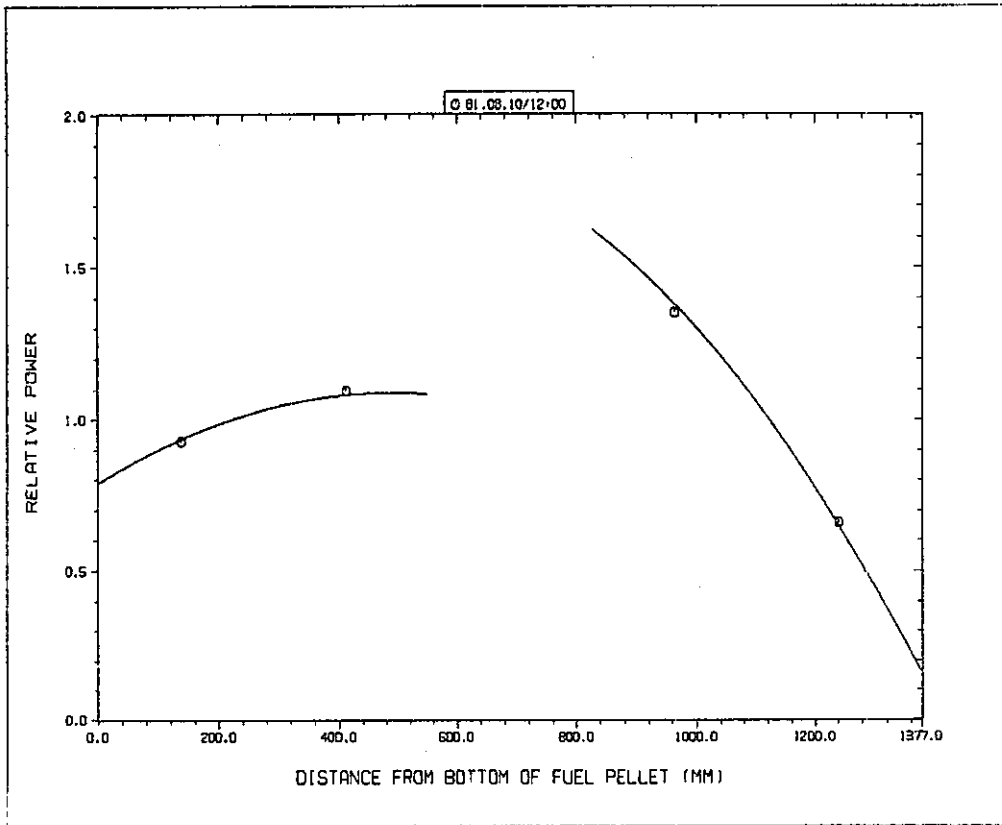

IFA529 AXIAL POWER PROFILE

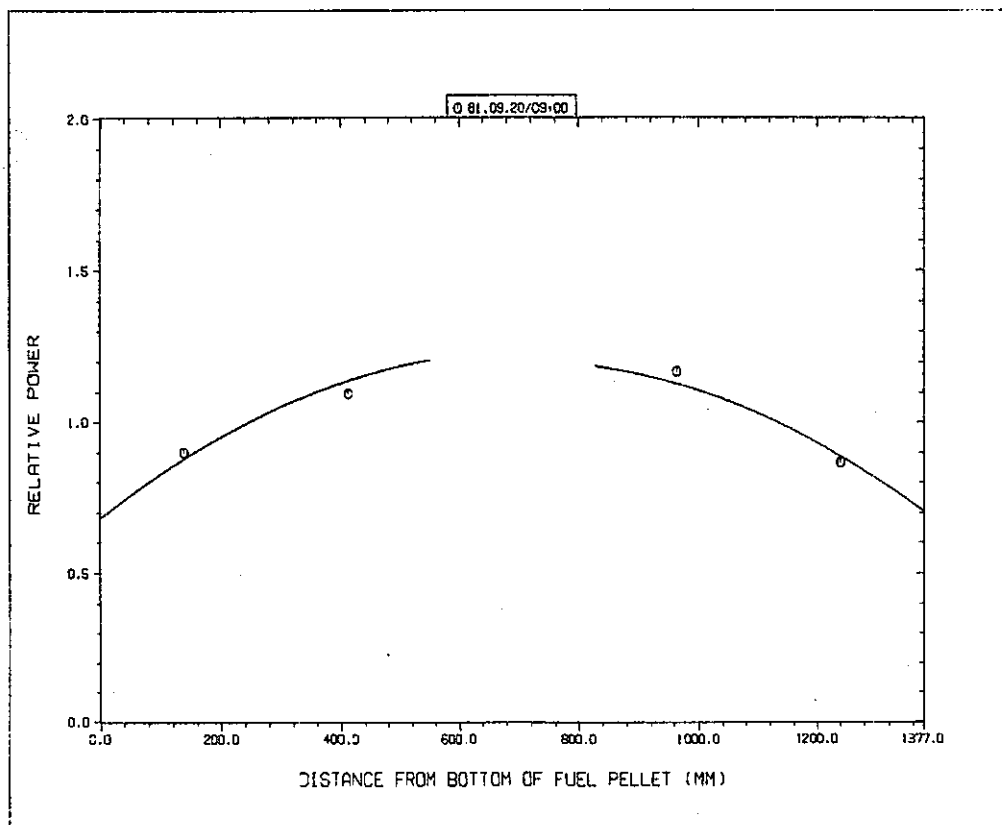

IFA529 AXIAL POWER PROFILE

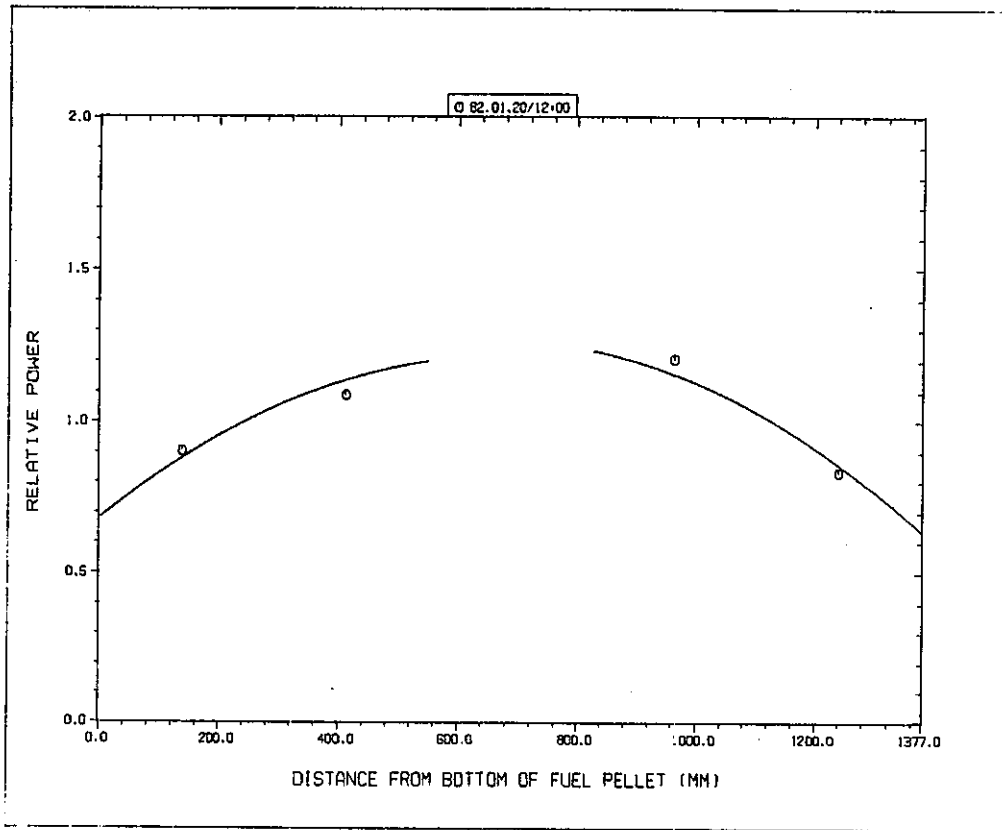

IFAS29 AXIAL POWER PROFILE

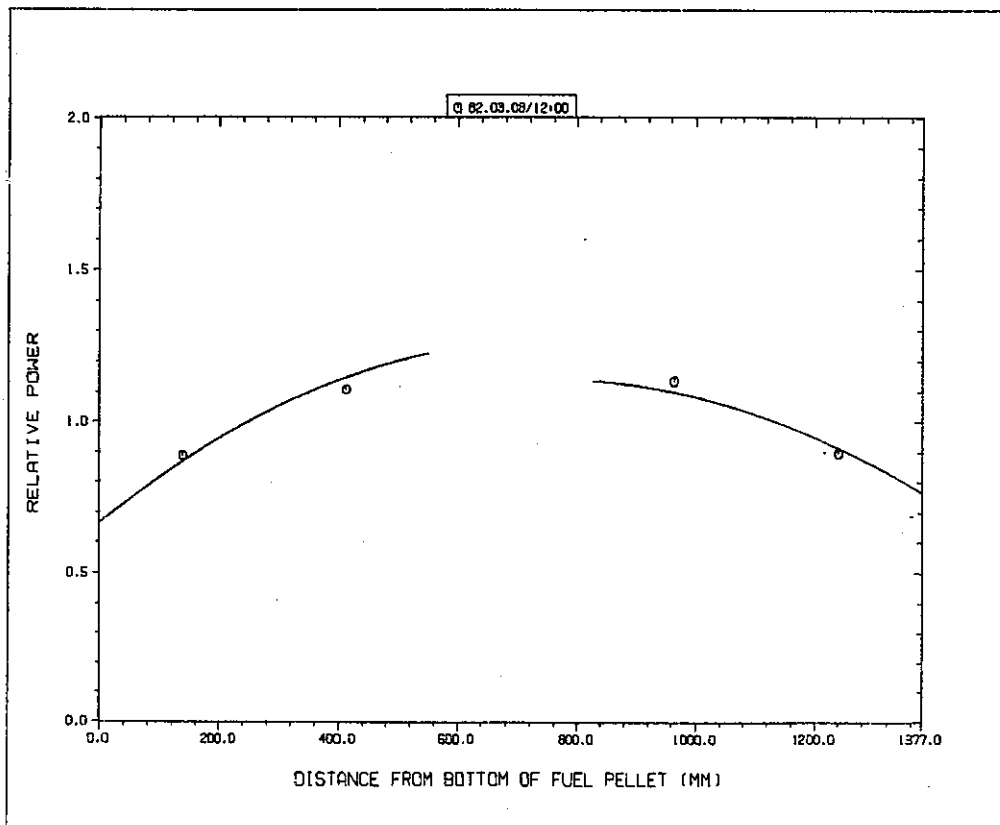

IFAS29 AXIAL POWER PROFILE

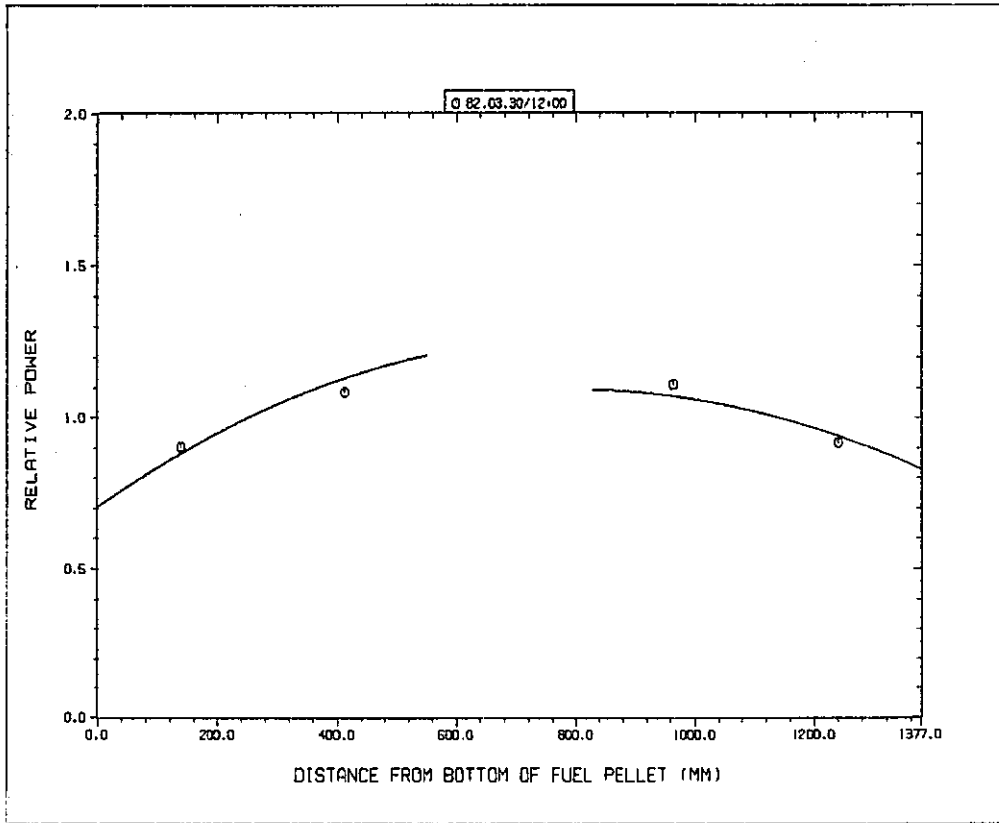

IFA529 AXIAL POWER PROFILE

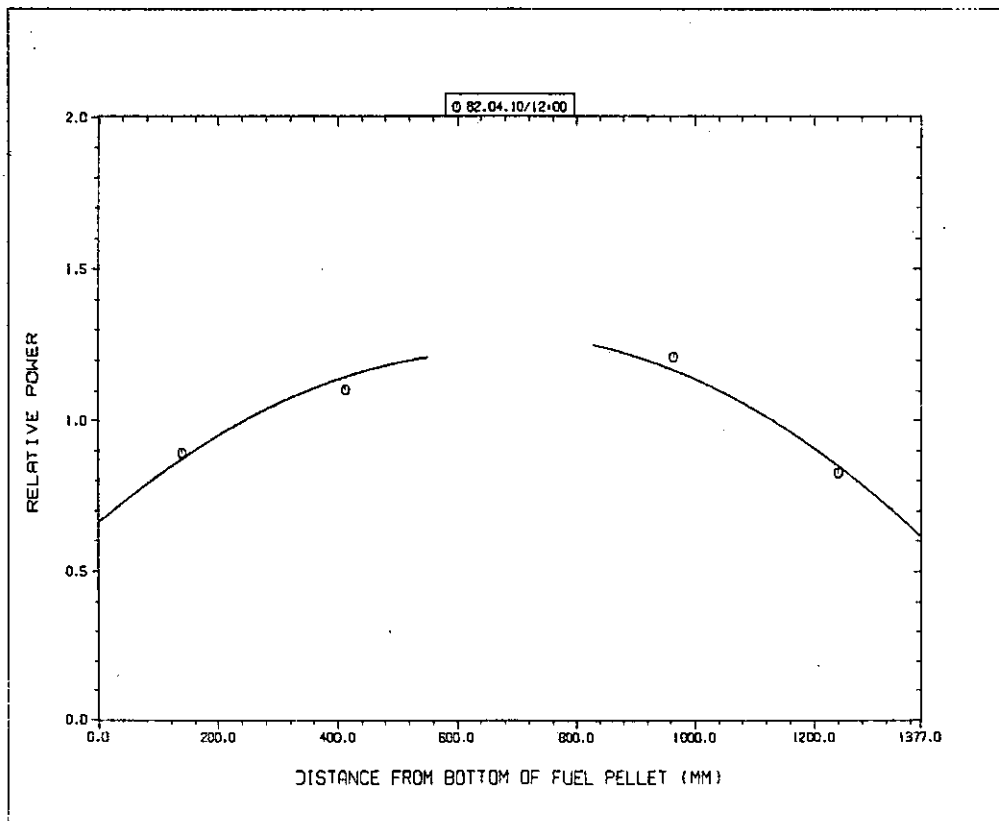

IFA529 AXIAL POWER PROFILE

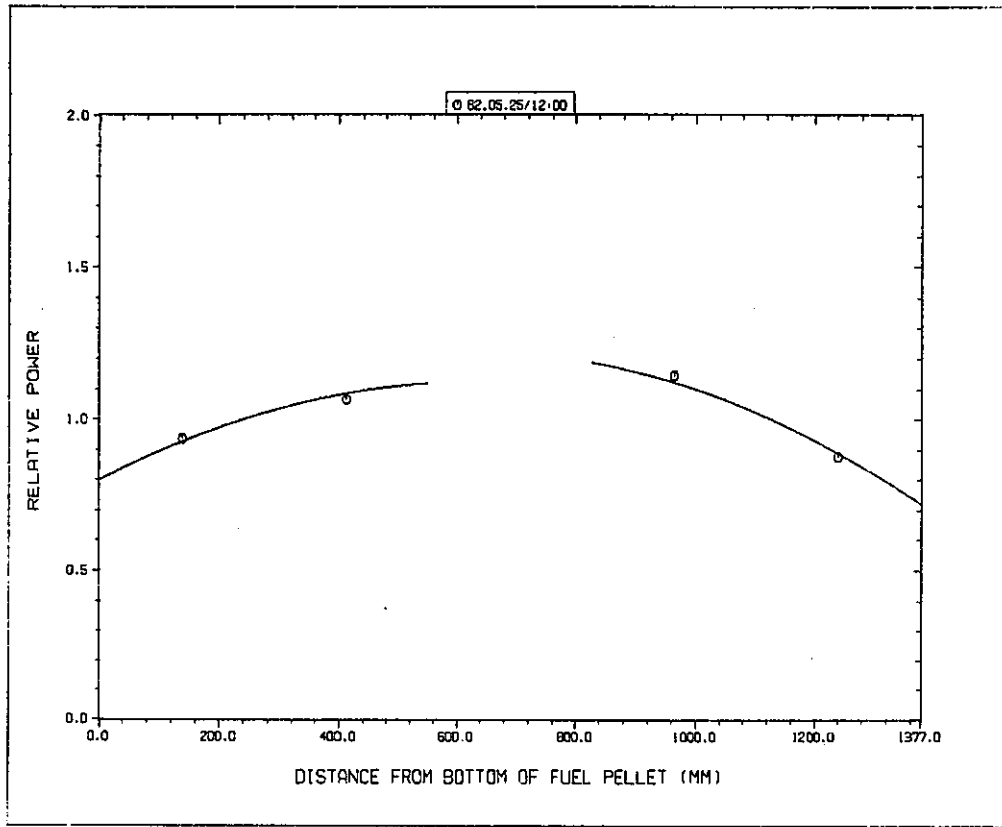

IF529 AXIAL POWER PROFILE

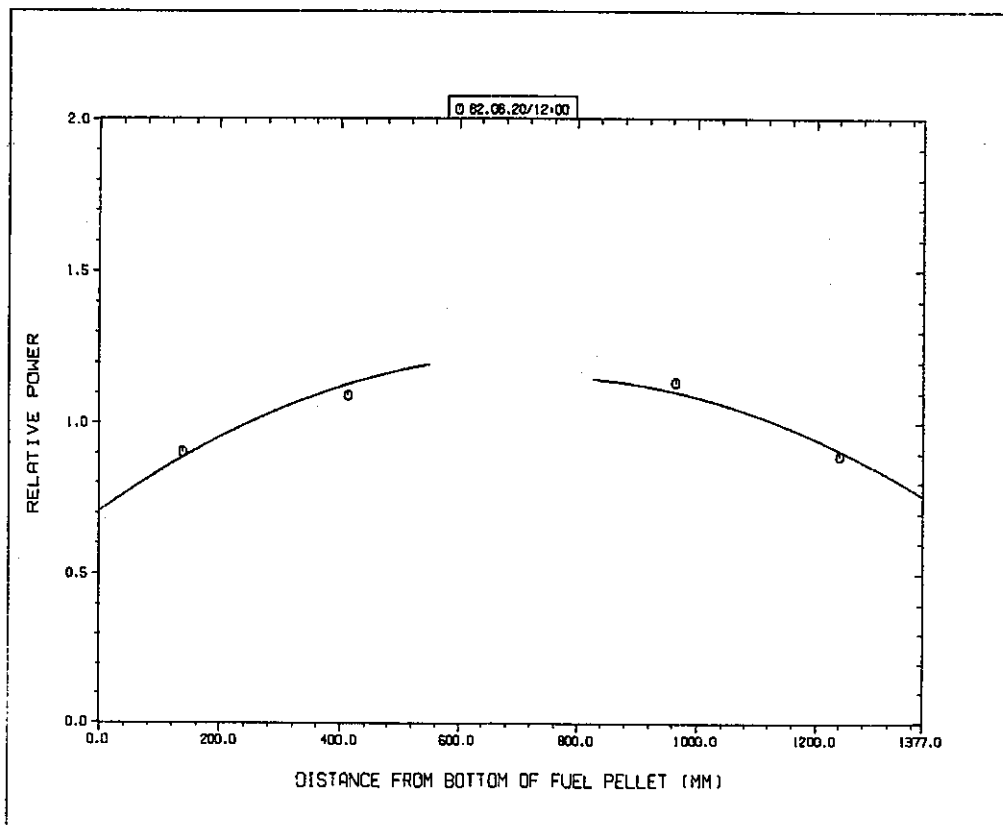

IF529 AXIAL POWER PROFILE

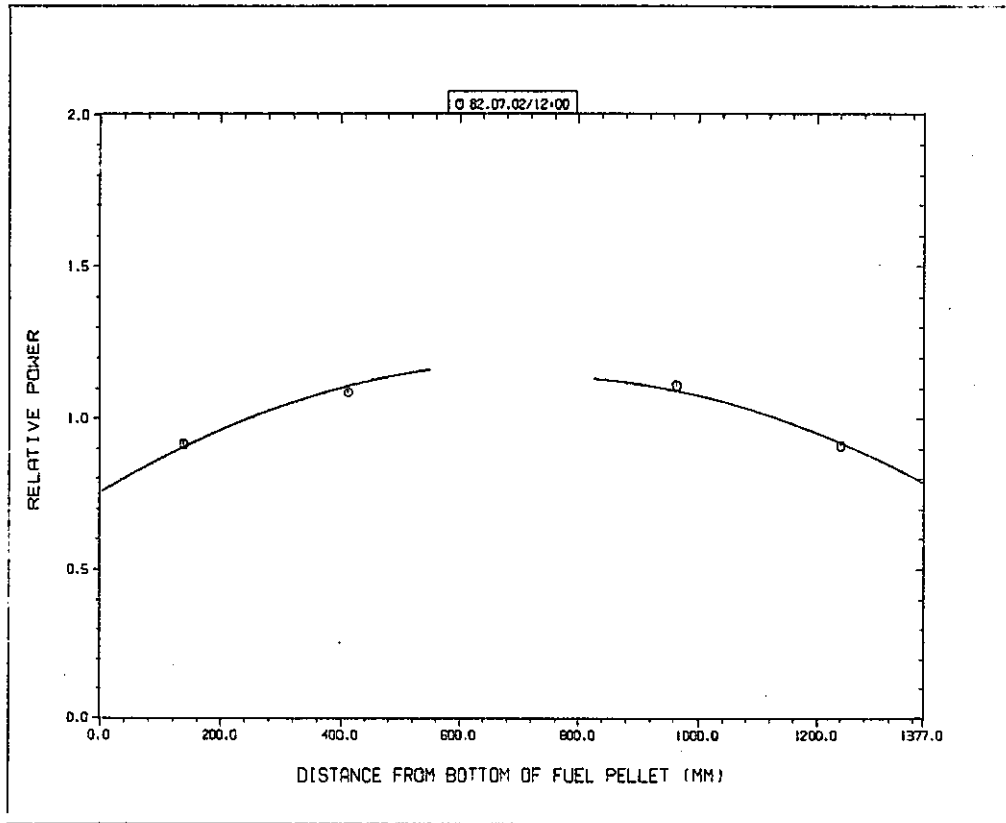

IFA529 AXIAL POWER PROFILE

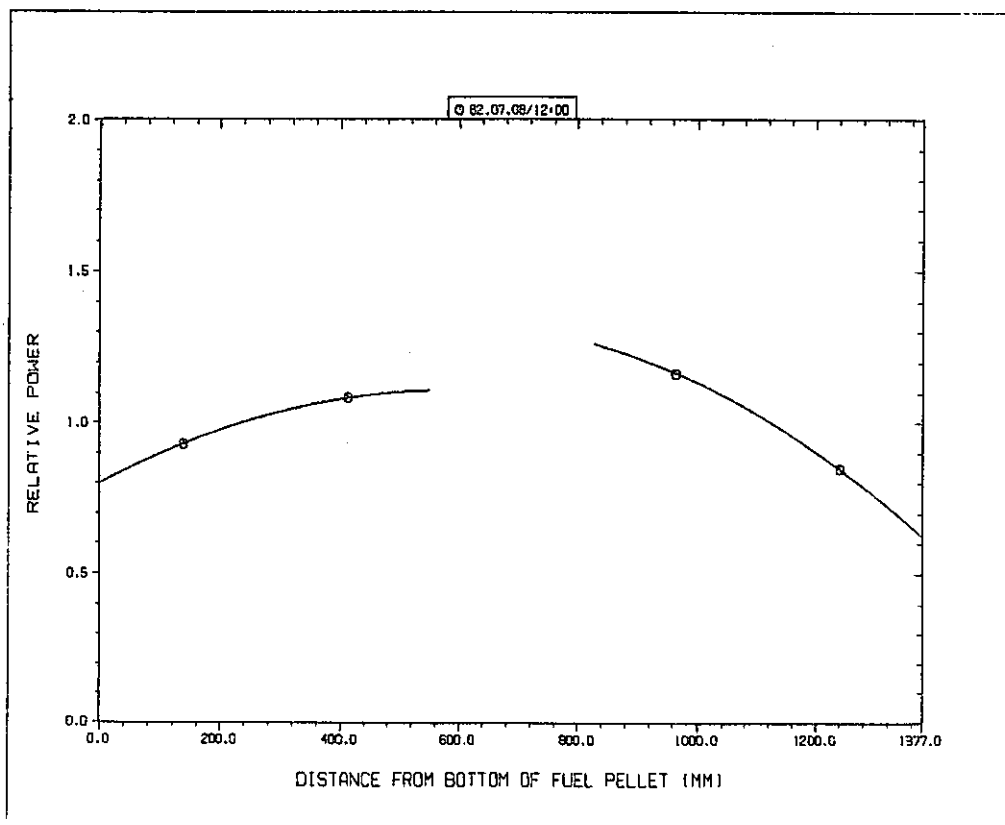

IFA529 AXIAL POWER PROFILE

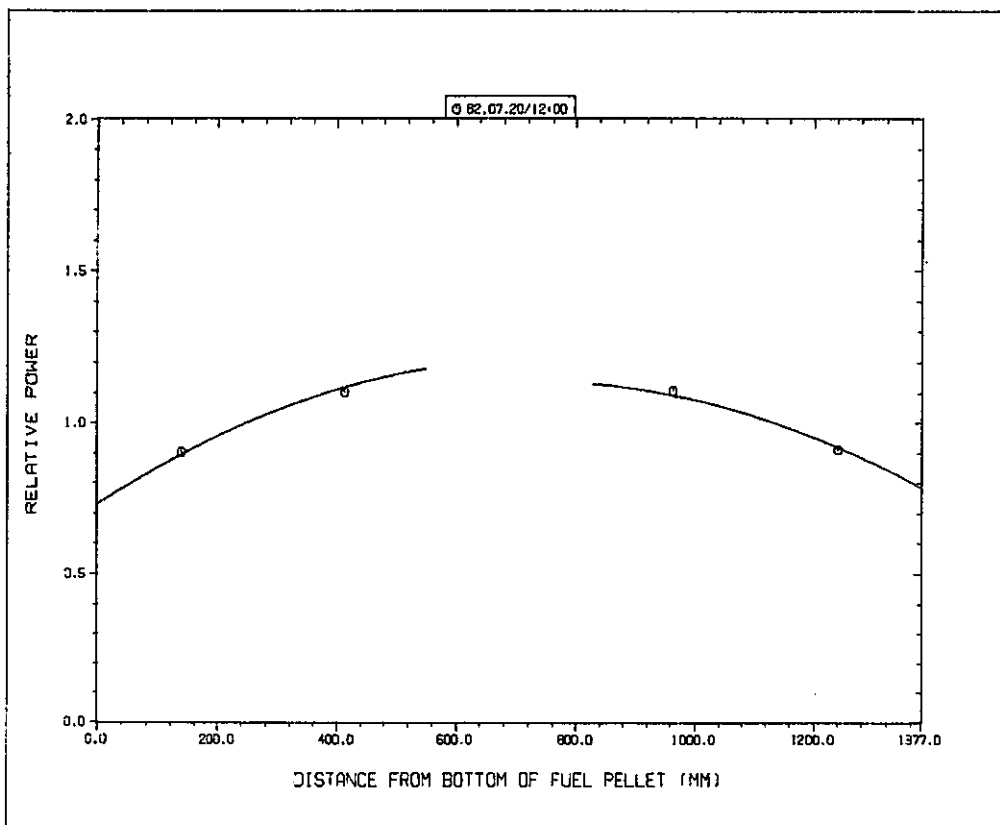

IFAS29 AXIAL POWER PROFILE

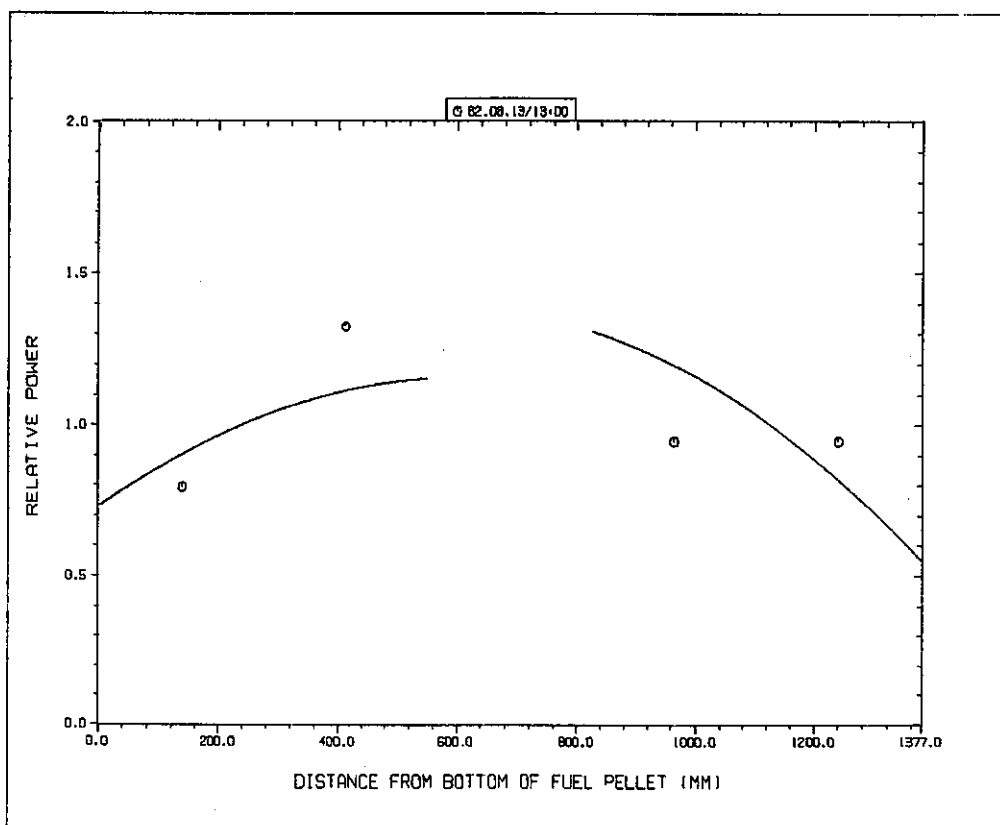

IFAS29 AXIAL POWER PROFILE

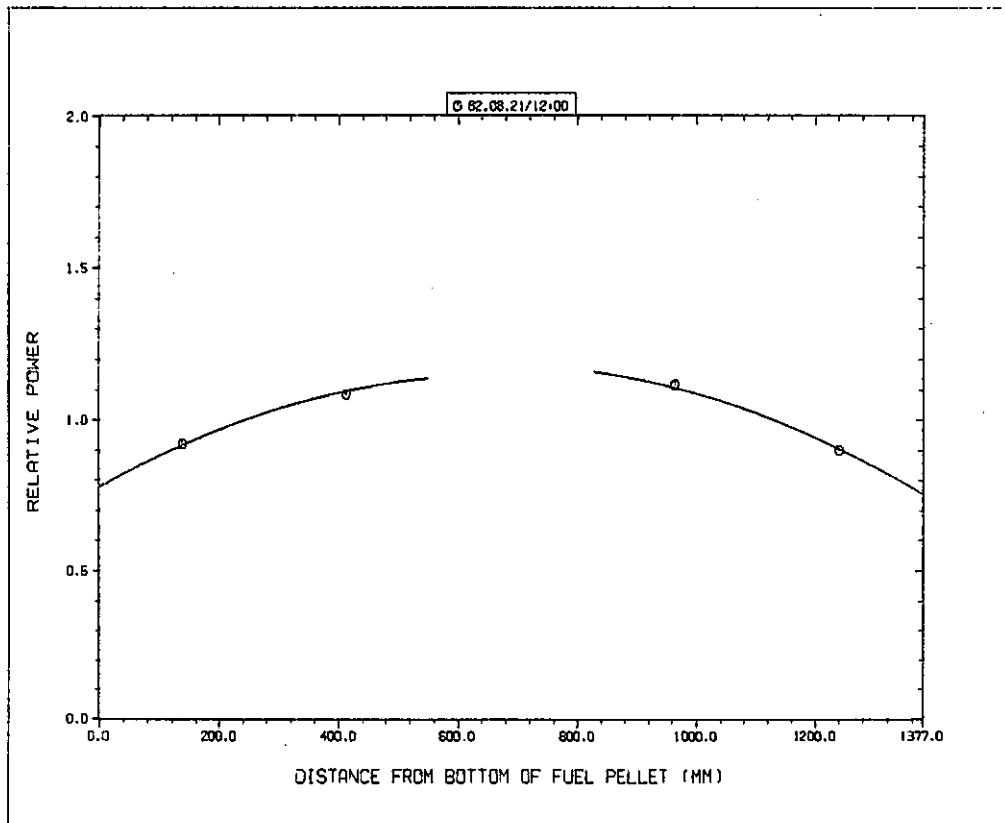

IFA529 AXIAL POWER PROFILE

付 録 4

I F A - 529 計 装 デ ー タ

～ P F (燃 料 棒 内 圧) デ ー タ ～

ロッド1～ロッド6, ロッド8, ロッド10, ロッド12

OECD HALDEN REACTOR PROJECT
 DATA FROM 1 JULY80 0 HRS TO 14 JULY80 23:45 HRS
 BURN-UP AT THE END OF FIRST/LAST DAY 7.339 MW/D/T UO2

PLOT 132

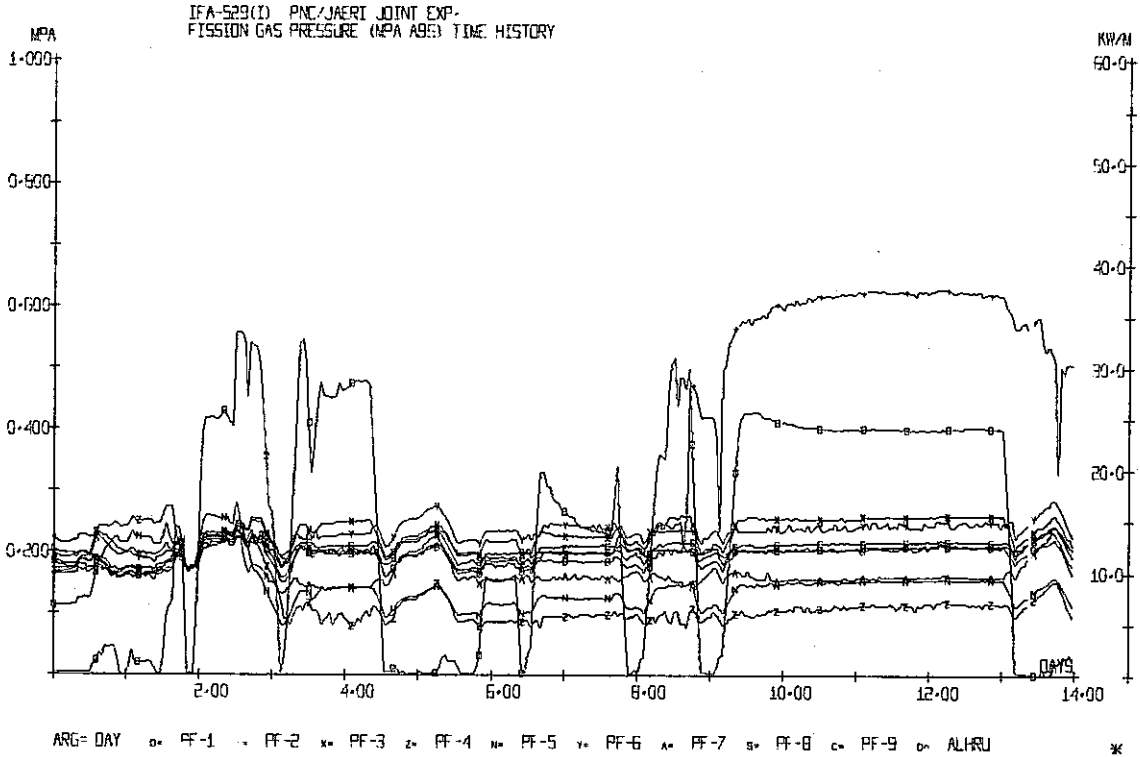

OECD HALDEN REACTOR PROJECT
 DATA FROM 15 JULY80 0 HRS TO 26 JULY80 23:45 HRS
 BURN-UP AT THE END OF FIRST/LAST DAY 376.707 MW/D/T UO2

PLOT 132

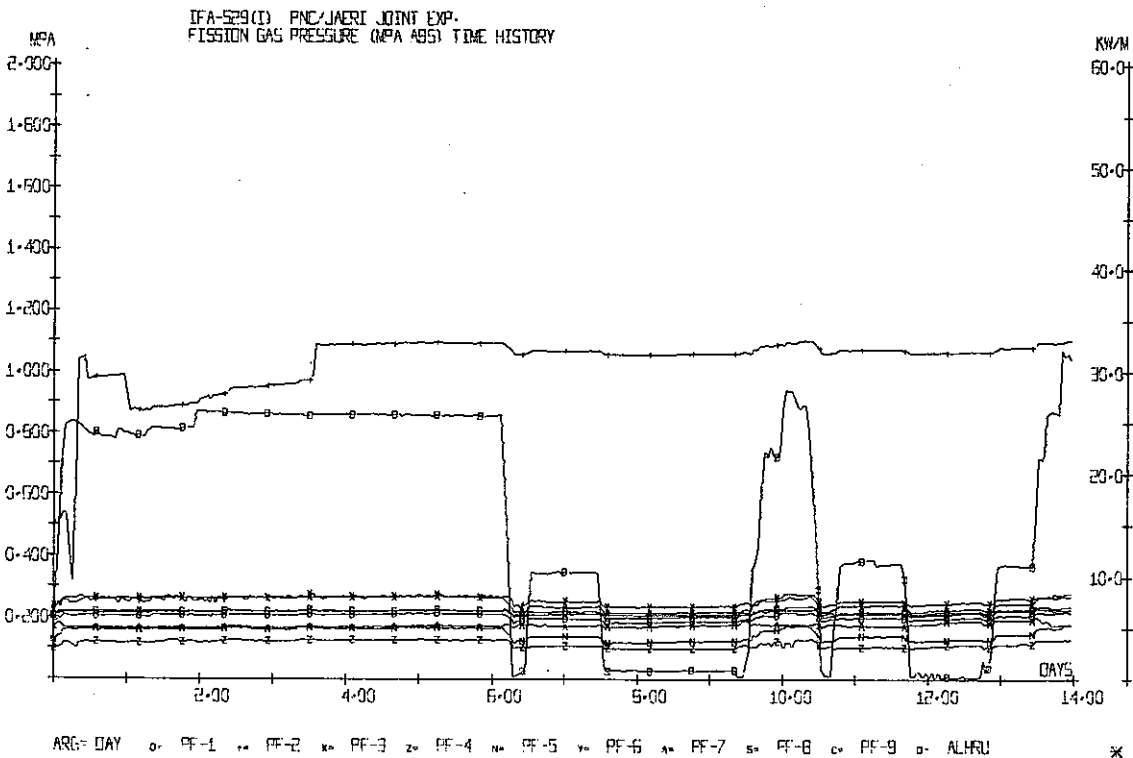

OECD HALDEN REACTOR PROJECT
 DATA FROM 29 JULY 80 0 HRS TO 11 AUG 80 23:00 HRS
 BURN-UP AT THE END OF FIRST/LAST DAY 73% 1131 MW/D USE

PLOT 132

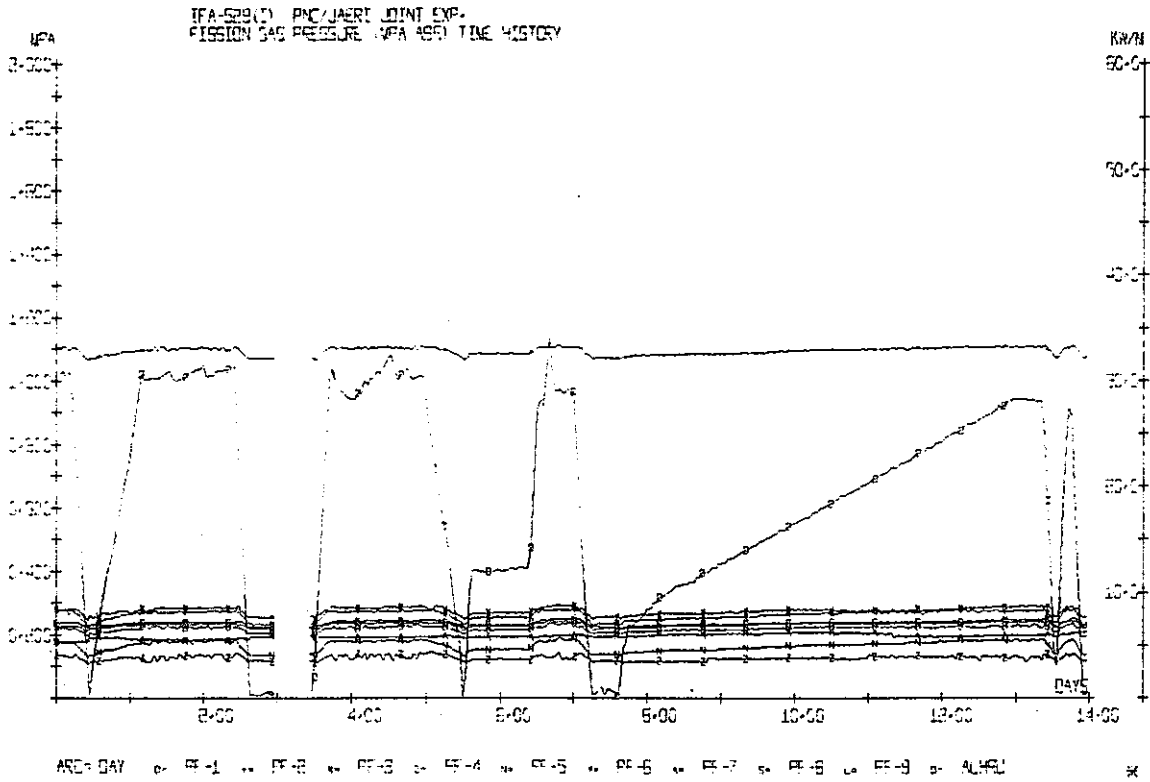

OECD HALDEN REACTOR PROJECT
 DATA FROM 12 AUG 80 0 HRS TO 17 AUG 80 23:00 HRS
 BURN-UP AT THE END OF FIRST/LAST DAY 117% 1281 MW/D USE

PLOT 133

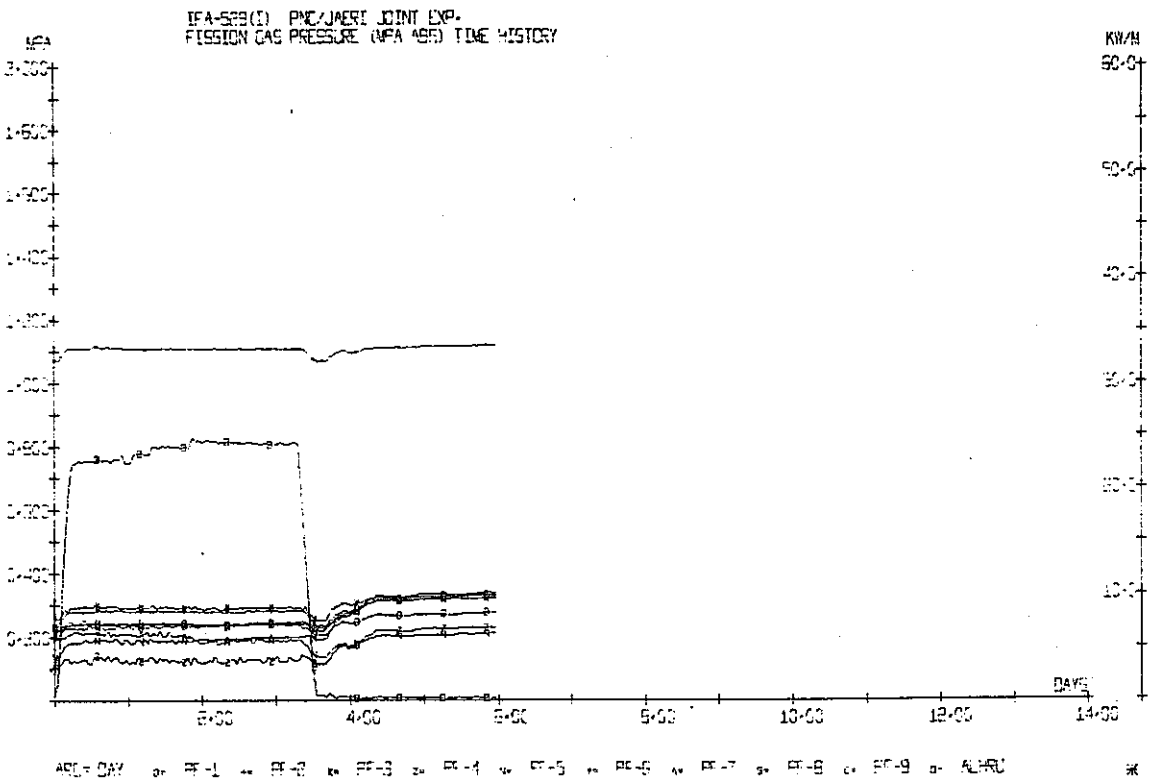

OECD HALDEN REACTOR PROJECT
 DATA FROM 10 SEPT80 0 HRS TO 23 SEPT80 2345 HRS
 BURN-UP AT THE END OF FIRST/LAST DAY 951 1272 MW/D/T UO2

PLOT 132

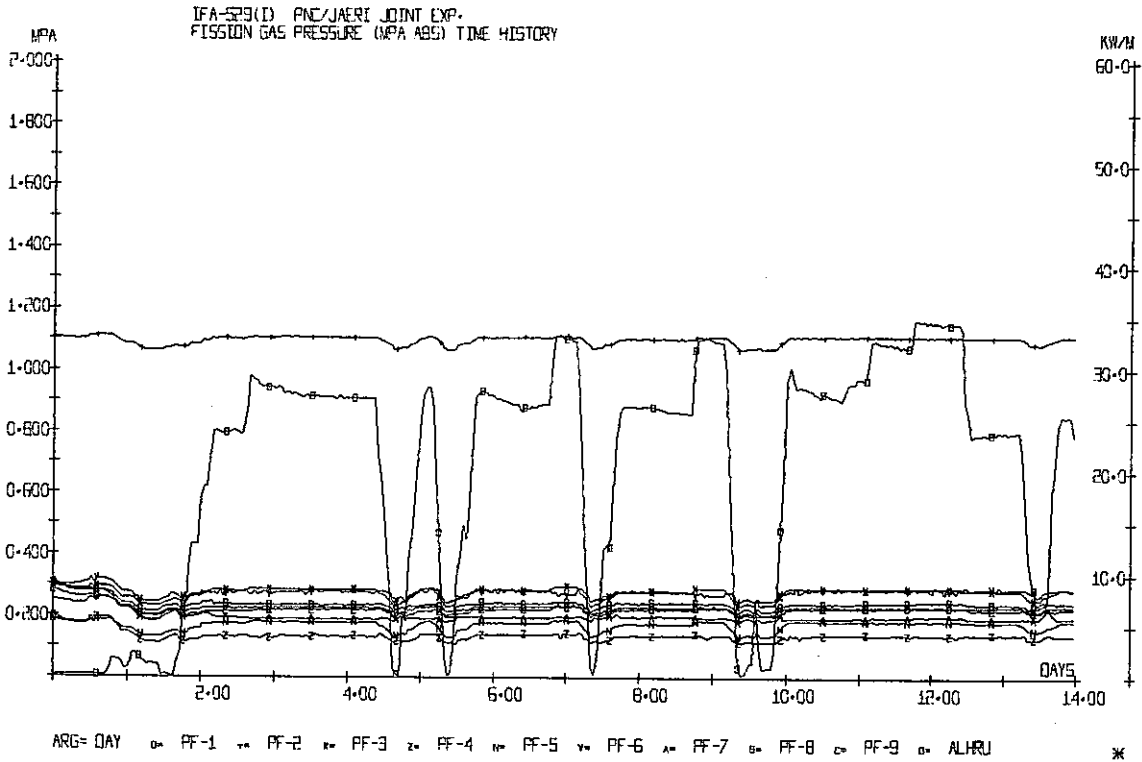

OECD HALDEN REACTOR PROJECT
 DATA FROM 24 SEPT80 0 HRS TO 30 SEPT80 2345 HRS
 BURN-UP AT THE END OF FIRST/LAST DAY 1284 1411 MW/D/T UO2

PLOT 132

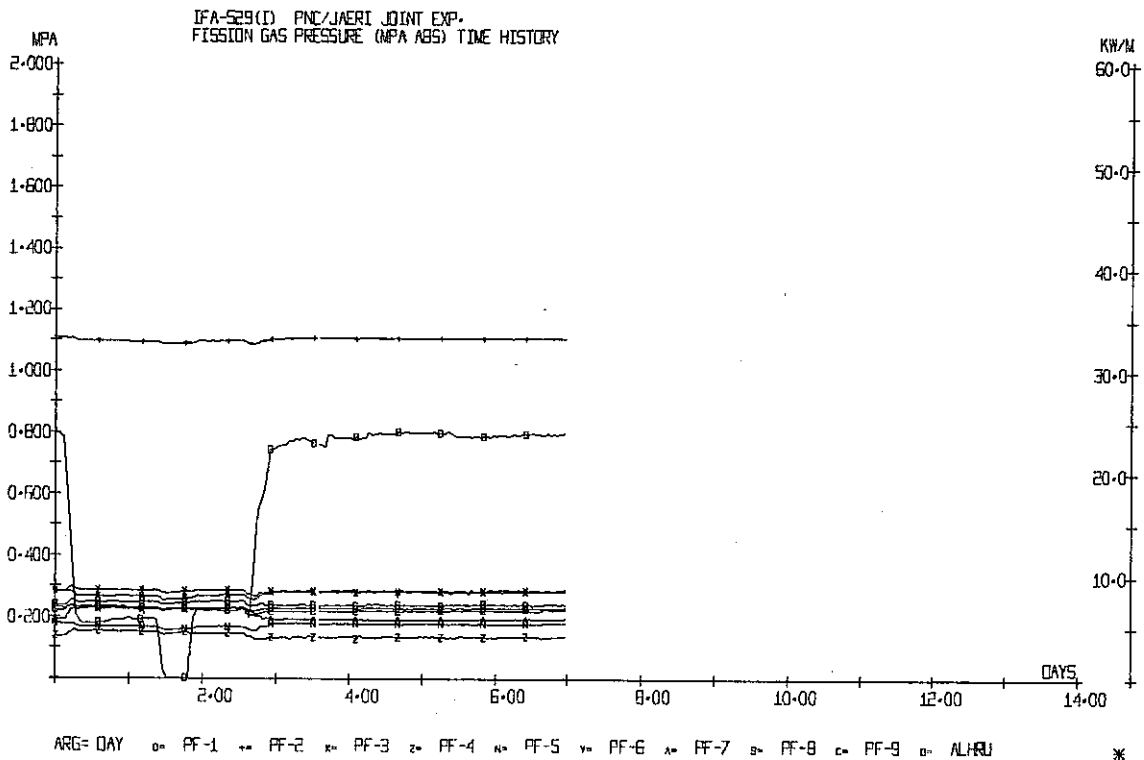

OECD HALDEN REACTOR PROJECT
 DATA FROM 1 OCT 80 0 HRS TO 5 OCT 80 2345 HRS
 BURN-UP AT THE END OF FIRST/LAST DAY 1.493 1.476 MW/D/T U32

PLOT 132

IFA-529(D) PNC/JAERI JOINT EXP.
 FISSION GAS PRESSURE (MPA ABS) TIME HISTORY

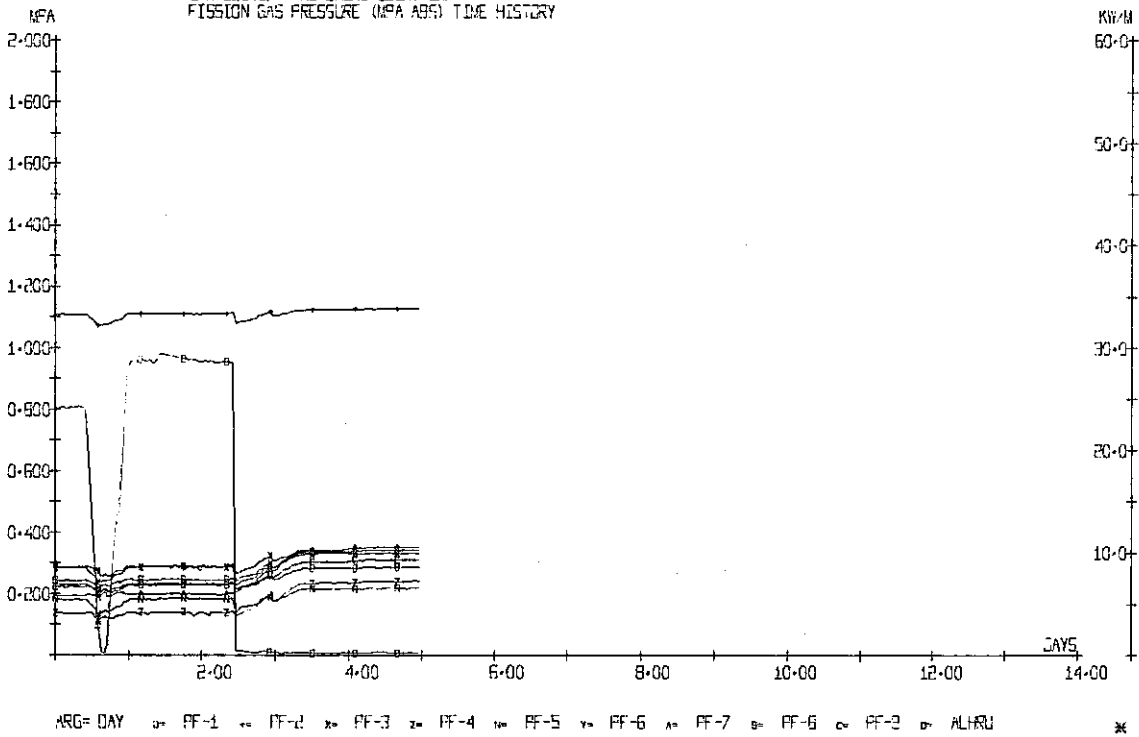

OECD HALDEN REACTOR PROJECT
 DATA FROM 12 DEC 80 0 HRS TO 23 DEC 80 1800 HRS
 BURN-UP AT THE END OF FIRST/LAST DAY 1.481 1.700 MW/D/T U32

PLOT 132

IFA-529(D) PNC/JAERI JOINT EXP.
 FISSION GAS PRESSURE (MPA ABS) TIME HISTORY

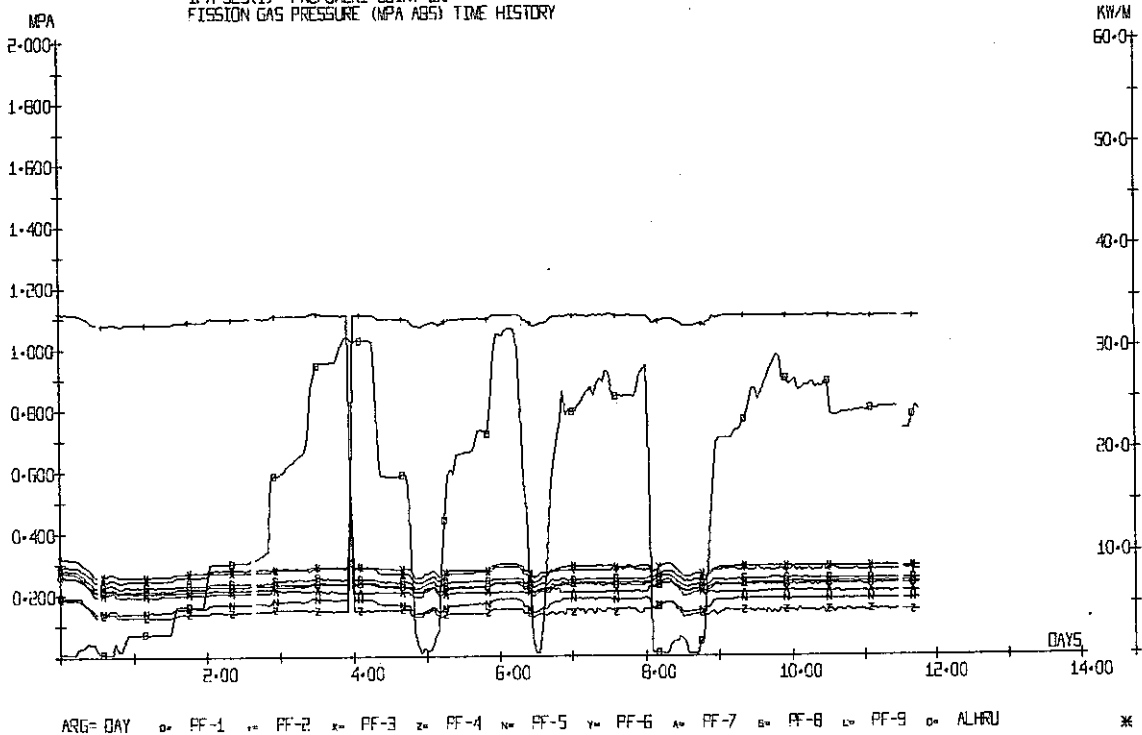

OECD HALDEN REACTOR PROJECT

DATA FROM 1 JAN 81 0 HRS TO 14 JAN 81 23:45 HRS
 BURN-UP AT THE END OF FIRST/LAST DAY 1325 -99 MWDT UO2

PLOT 132

IFA-523(1) PNC/JAERI JOINT EXP.
 FISSION GAS PRESSURE (MPA ABS) TIME HISTORY

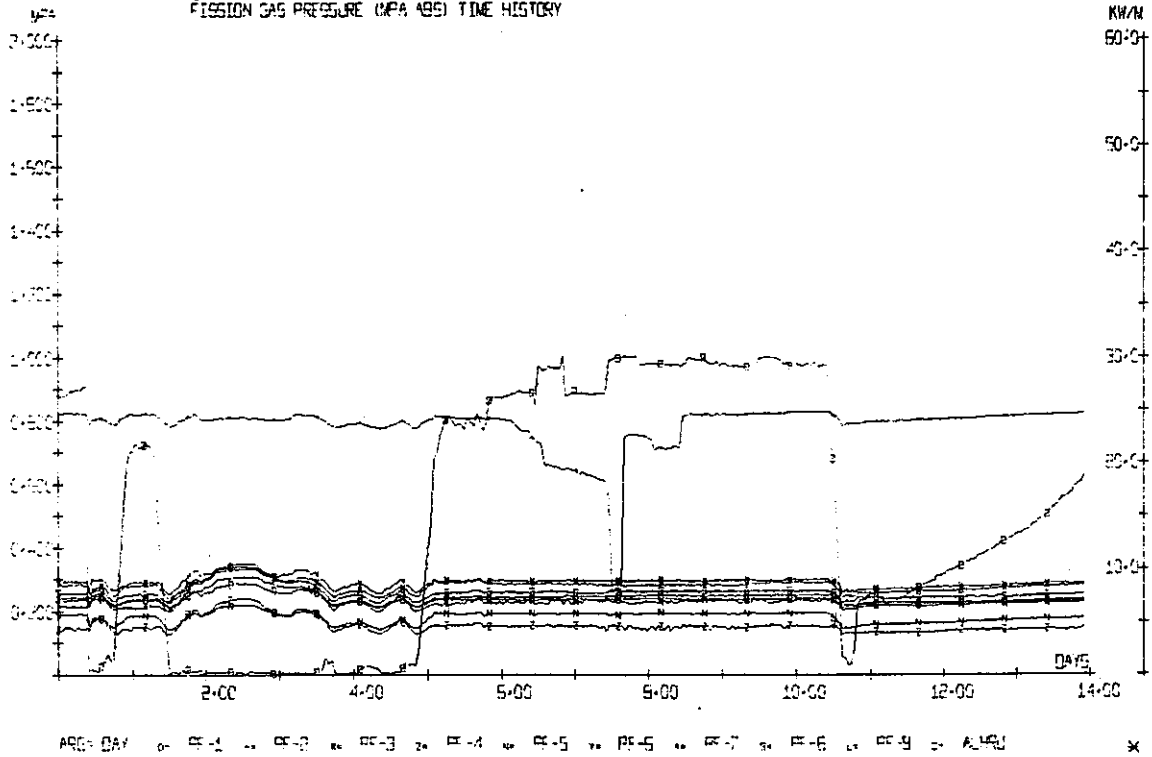

OECD HALDEN REACTOR PROJECT

DATA FROM 15 JAN 81 0 HRS TO 19 JAN 81 23:45 HRS
 BURN-UP AT THE END OF FIRST/LAST DAY 1325 -99 MWDT UO2

PLOT 132

IFA-523(1) PNC/JAERI JOINT EXP.
 FISSION GAS PRESSURE (MPA ABS) TIME HISTORY

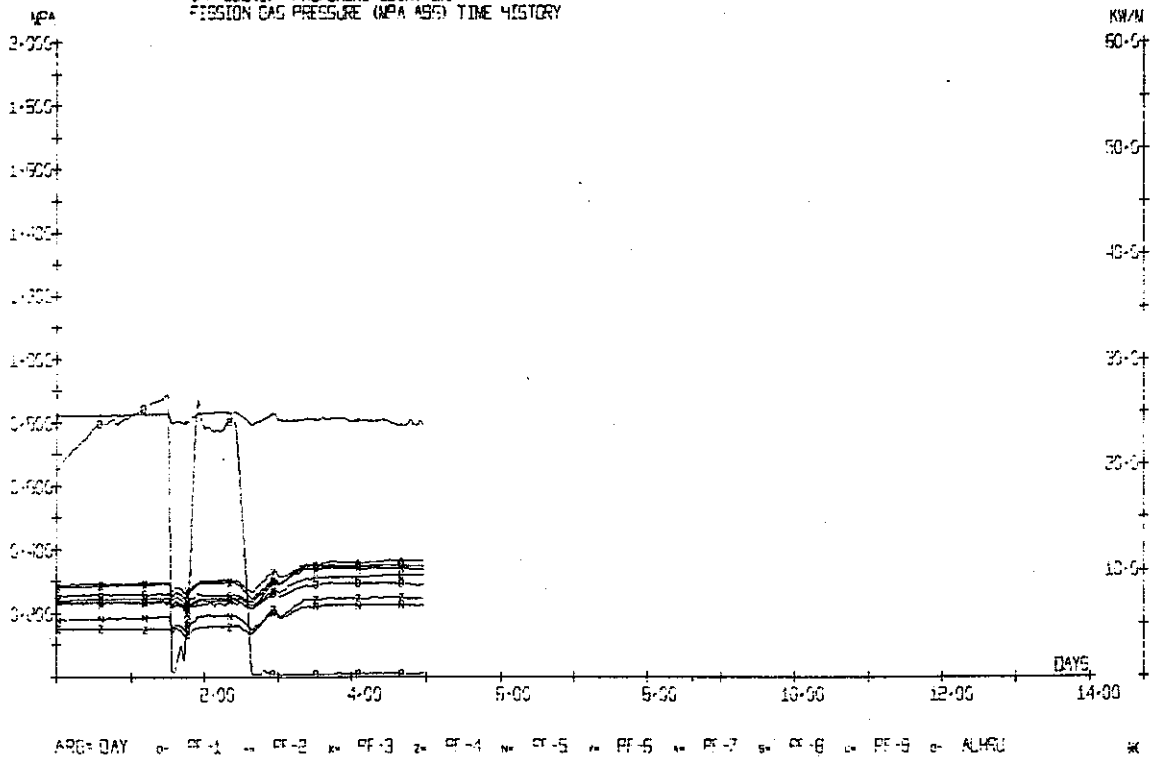

OECD HALDEN REACTOR PROJECT
 DATA FROM 29 JAN 81 0 HRS TO 9 FEB 81 23:45 HRS
 BURN-UP AT THE END OF FIRST/LAST DAY -937 2:071 MW/D/T UOE

PLOT 132

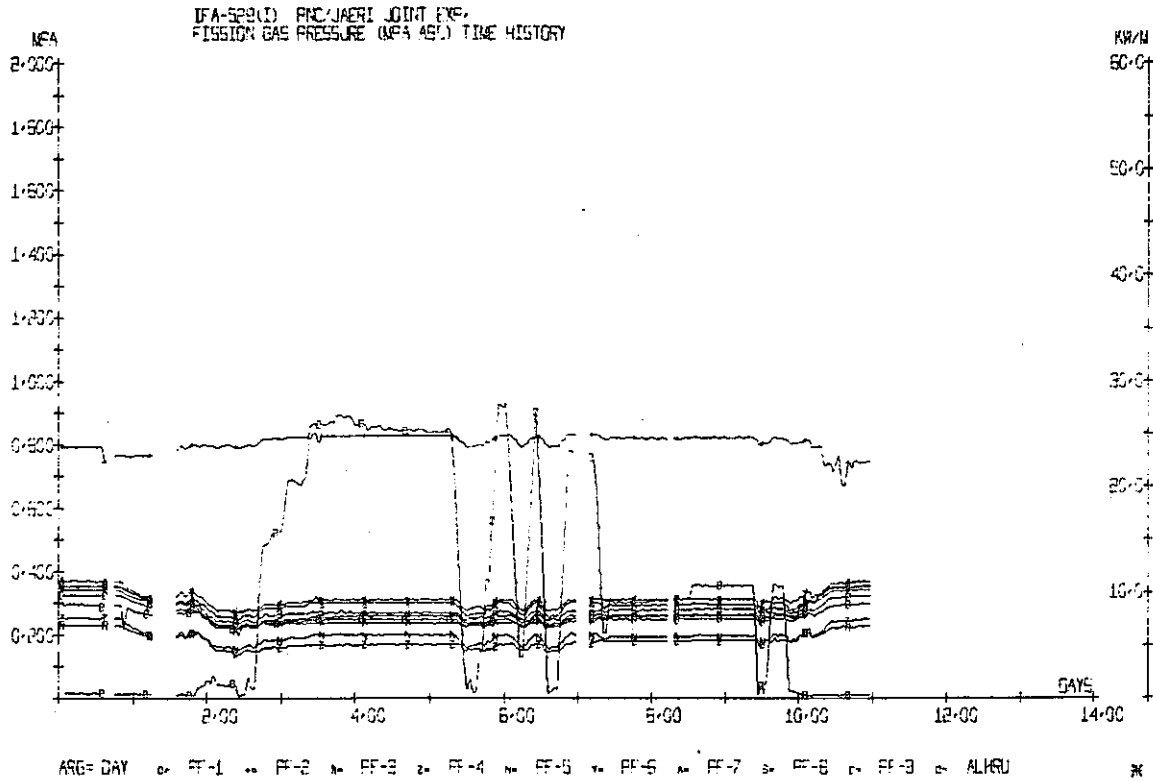

OECD HALDEN REACTOR PROJECT
 DATA FROM 1 APR 81 0 HRS TO 14 APR 81 23:45 HRS
 BURN-UP AT THE END OF FIRST/LAST DAY 2471 2584 MW/D/T UOE

PLOT 132

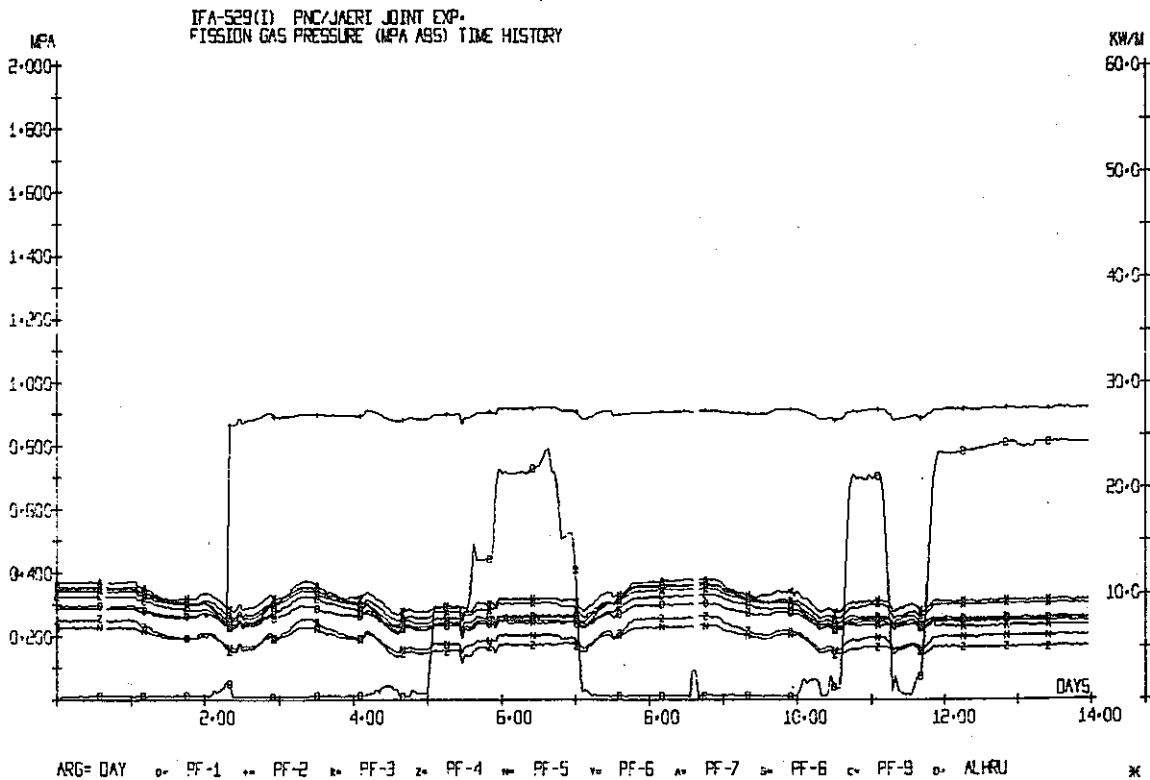

OECD HALDEN REACTOR PROJECT

DATA FROM 15 APR 81 0 HRS TO 29 APR 81 23:45 HRS
 BURN-UP AT THE END OF FIRST/LAST DAY 2613 2921 MW/D/T UO2

PLOT 132

IFA-529(D) PNC/JAERI JOINT EXP.
 FISSION GAS PRESSURE (MPA ABS) TIME HISTORY

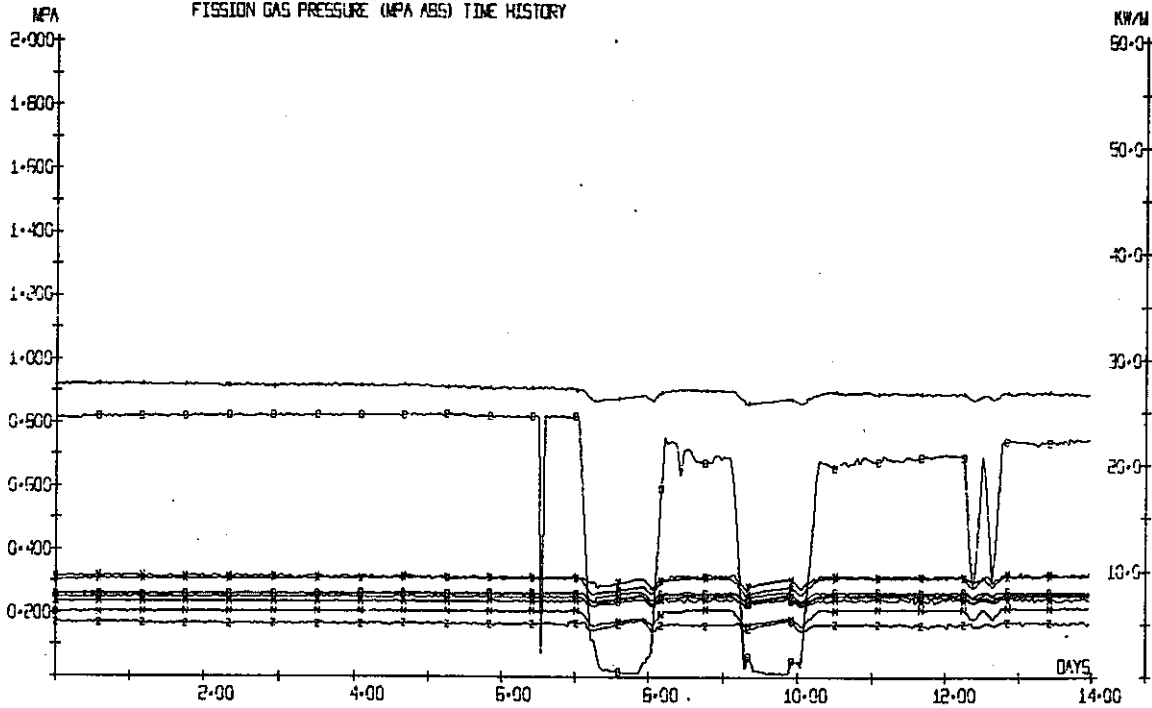

ARG= DAY ○ PF-1 ● PF-2 × PF-3 ◊ PF-4 ▨ PF-5 ▼ PF-6 ▲ PF-7 ◓ PF-8 ◑ PF-9 ◒ ALHRU *

OECD HALDEN REACTOR PROJECT

DATA FROM 29 APR 81 0 HRS TO 12 MAY 81 23:45 HRS
 BURN-UP AT THE END OF FIRST/LAST DAY 2951 3263 MW/D/T UO2

PLOT 132

IFA-529(D) PNC/JAERI JOINT EXP.
 FISSION GAS PRESSURE (MPA ABS) TIME HISTORY

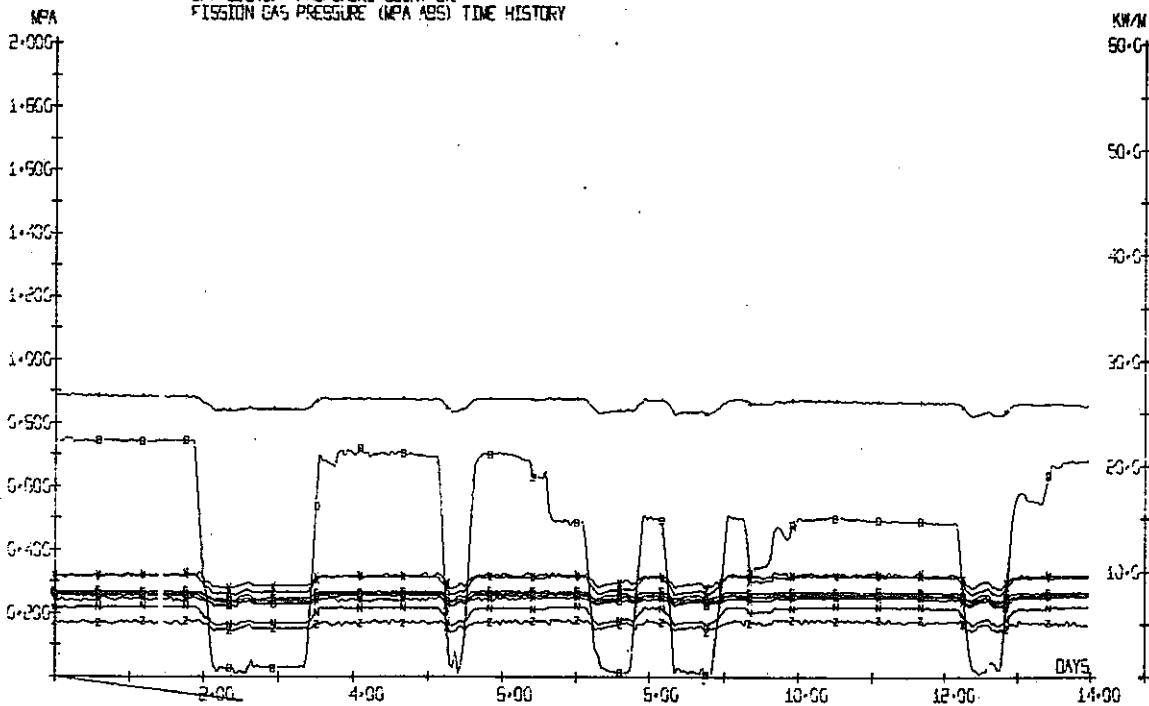

ARG= DAY ○ PF-1 ● PF-2 × PF-3 ◊ PF-4 ▨ PF-5 ▼ PF-6 ▲ PF-7 ◓ PF-8 ◑ PF-9 ◒ ALHRU *

OECD HALDEN REACTOR PROJECT
 DATA FROM 13 MAY 81 0 HRS TO 26 MAY 81 23:45 HRS
 BURN-UP AT THE END OF FIRST/LAST DAY 3232 357 MW/D/T UO2

PLOT 132

IFA-529(I) PNC/JAERI JOINT EXP.
 FISSION GAS PRESSURE (MPA ABS) TIME HISTORY

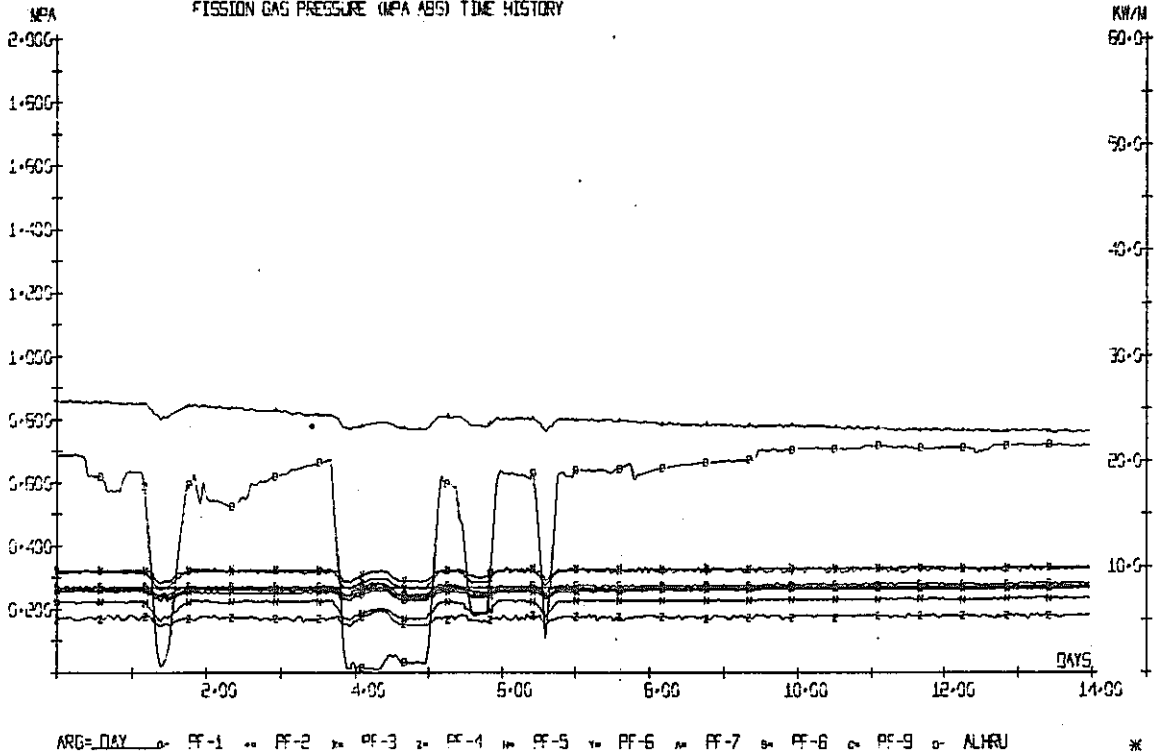

OECD HALDEN REACTOR PROJECT
 DATA FROM 27 MAY 81 0 HRS TO 6 JUNE 81 23:45 HRS
 BURN-UP AT THE END OF FIRST/LAST DAY 3587 3662 MW/D/T UO2

PLOT 132

IFA-529(I) PNC/JAERI JOINT EXP.
 FISSION GAS PRESSURE (MPA ABS) TIME HISTORY

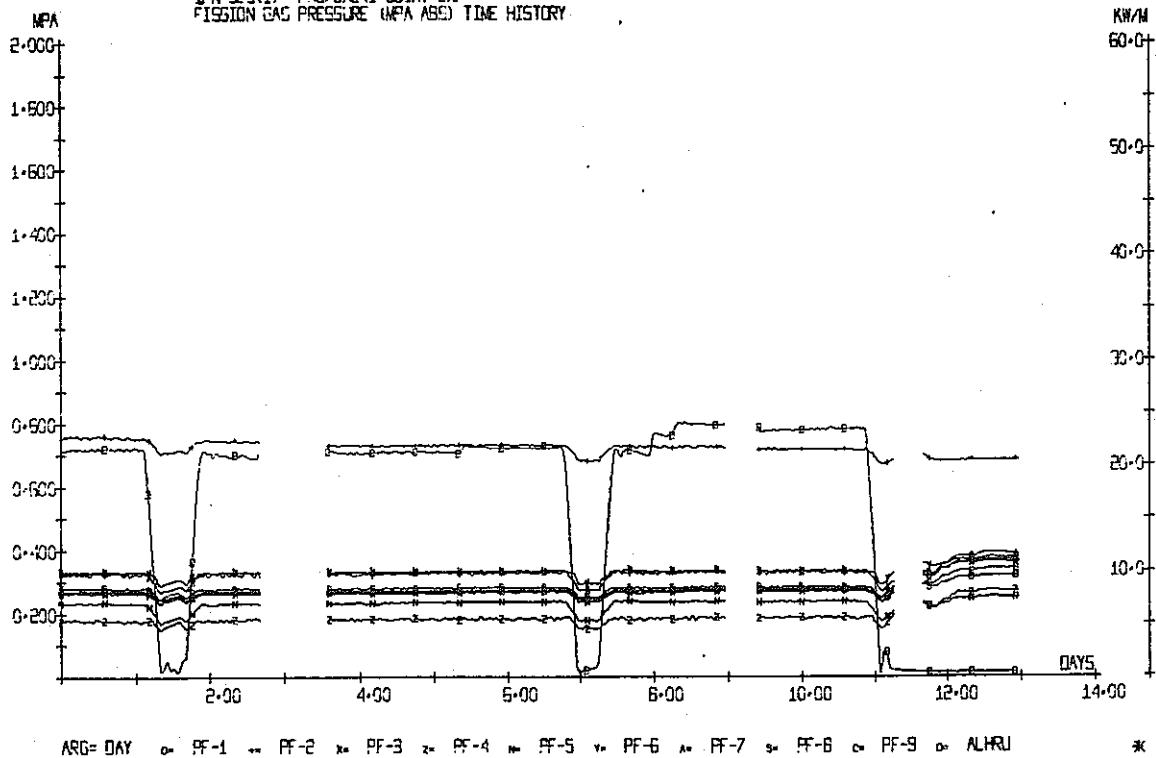

OECD HALDEN REACTOR PROJECT

DATA FROM 20 JUNE 81 0 HRS TO 30 JUNE 81 23:45 HRS
 BURN-UP AT THE END OF FIRST/LAST DAY 3862 4051 MWDT UO2

PLOT 132

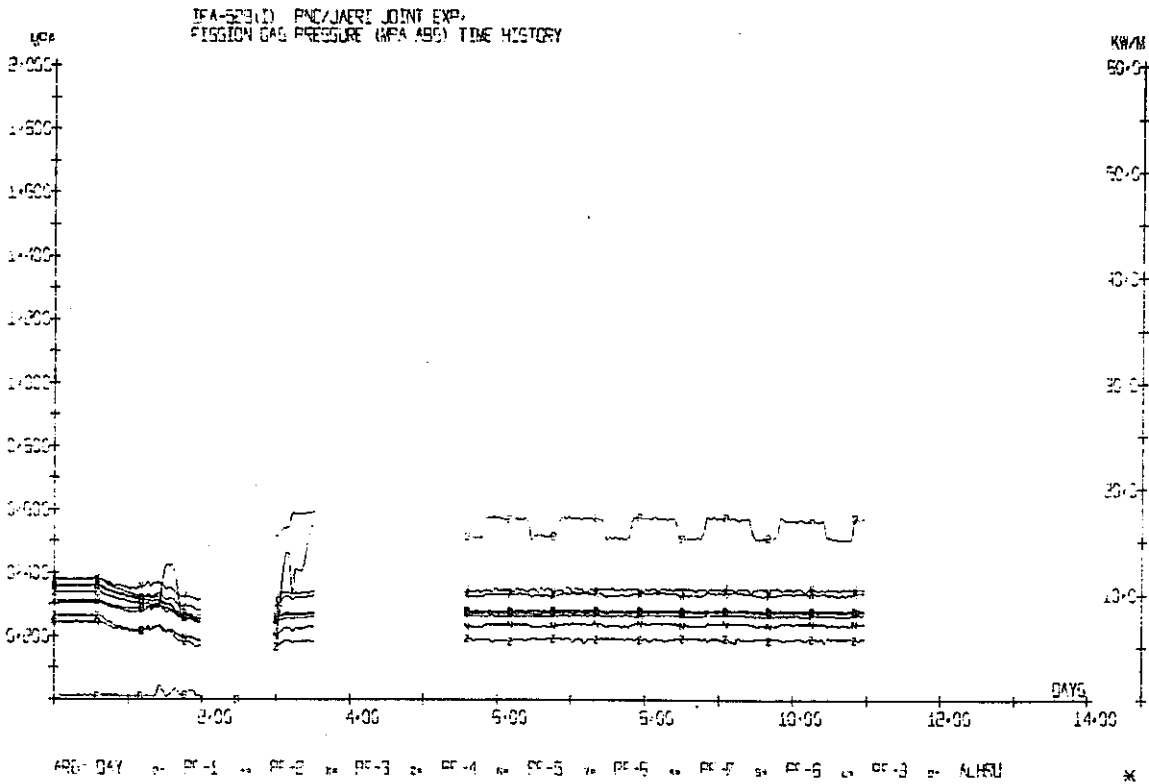

OECD HALDEN REACTOR PROJECT

DATA FROM 1 JULY 81 0 HRS TO 14 JULY 81 23:45 HRS
 BURN-UP AT THE END OF FIRST/LAST DAY 4087 4466 MWDT UO2

PLOT 132

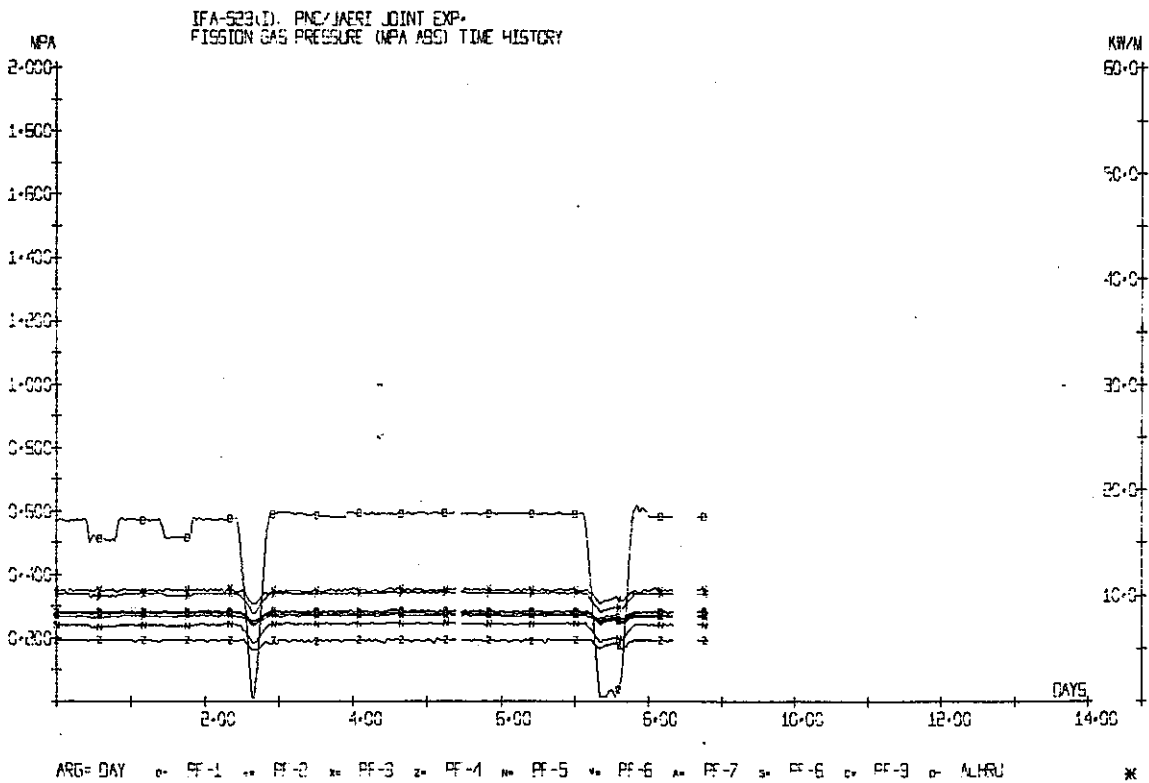

OECD HALDEN REACTOR PROJECT
DATA FROM 15 JULY 81 03 HRS TO 25 JULY 81 2345 HRS
BURN-UP AT THE END OF FIRST/LAST DAY 4478 4520 MWDT UOE

PLOT 132

IFA-523(D) PNC/JAERI JOINT EXP.
FISSION GAS PRESSURE (GPA ABS) TIME HISTORY

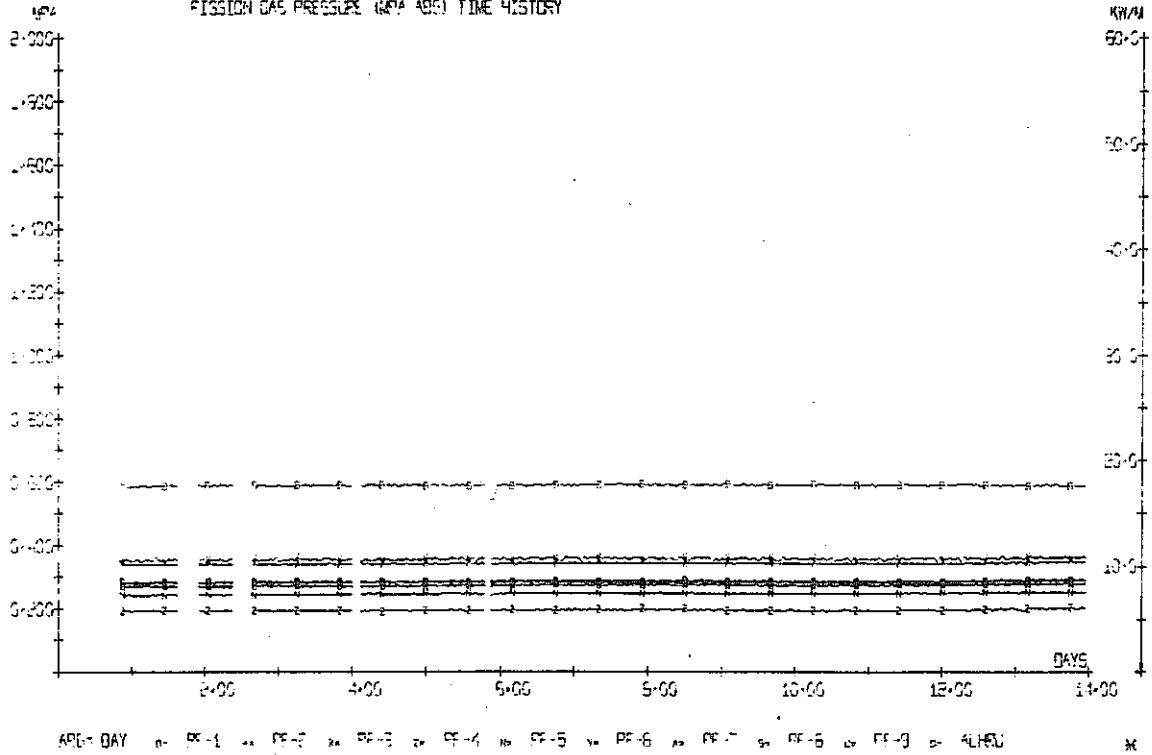

OECD HALDEN REACTOR PROJECT
DATA FROM 25 JULY 81 03 HRS TO 11 AUG 81 2345 HRS
BURN-UP AT THE END OF FIRST/LAST DAY 4546 5307 MWDT UOE

PLOT 132

IFA-523(D) PNC/JAERI JOINT EXP.
FISSION GAS PRESSURE (GPA ABS) TIME HISTORY

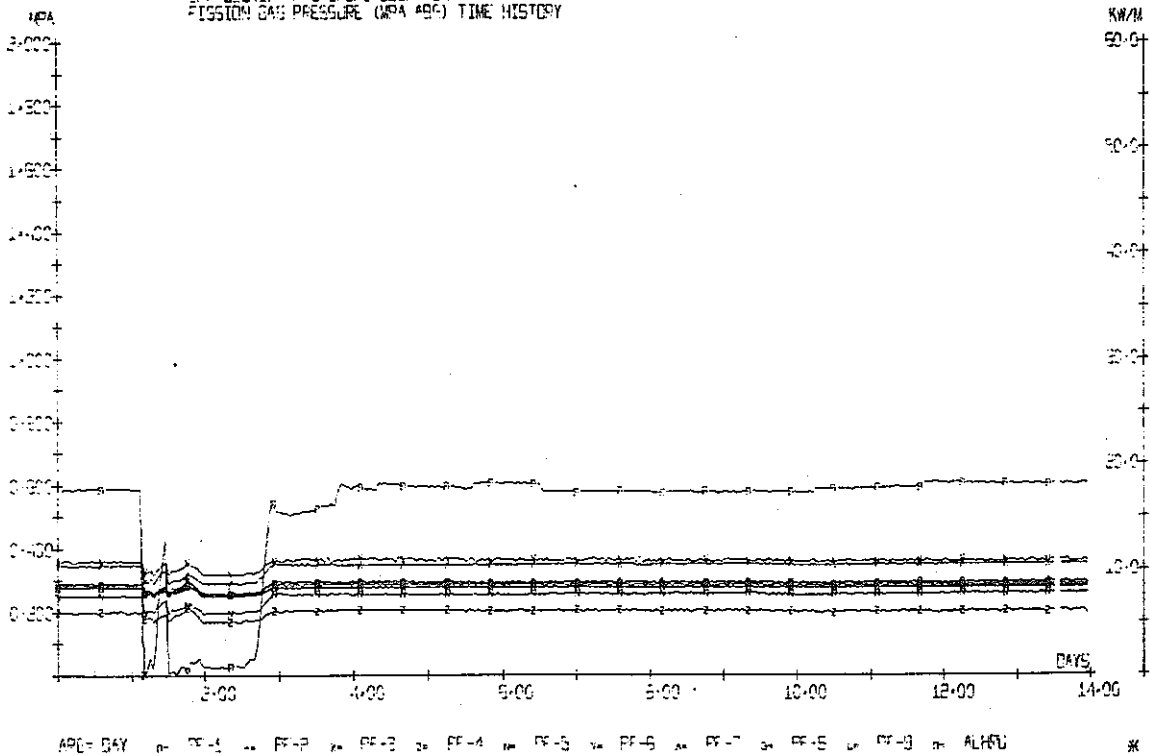

OECD HALDEN REACTOR PROJECT
 DATA FROM 12 AUG 81 0 HRS TO 22 AUG 81 2345 HRS
 BURN-UP AT THE END OF FIRST/LAST DAY 5375 5575 MWDT UO2

PLOT 132

IFA-523(D) PNC/JAERI JOINT EXP.
 FISSION GAS PRESSURE (MPA ABS) TIME HISTORY

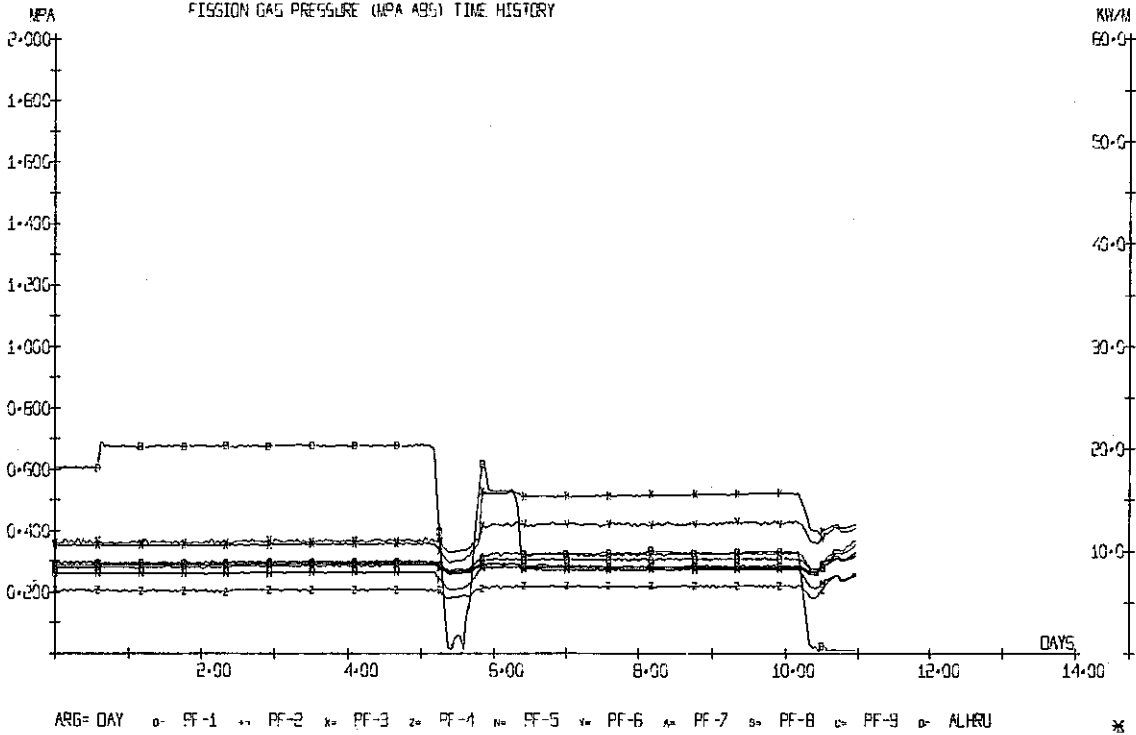

OECD HALDEN REACTOR PROJECT
 DATA FROM 1 SEPT 81 0 HRS TO 14 SEPT 81 2345 HRS
 BURN-UP AT THE END OF FIRST/LAST DAY 5577 5875 MWDT UO2

PLOT 132

IFA-523(D) PNC/JAERI JOINT EXP.
 FISSION GAS PRESSURE (MPA ABS) TIME HISTORY

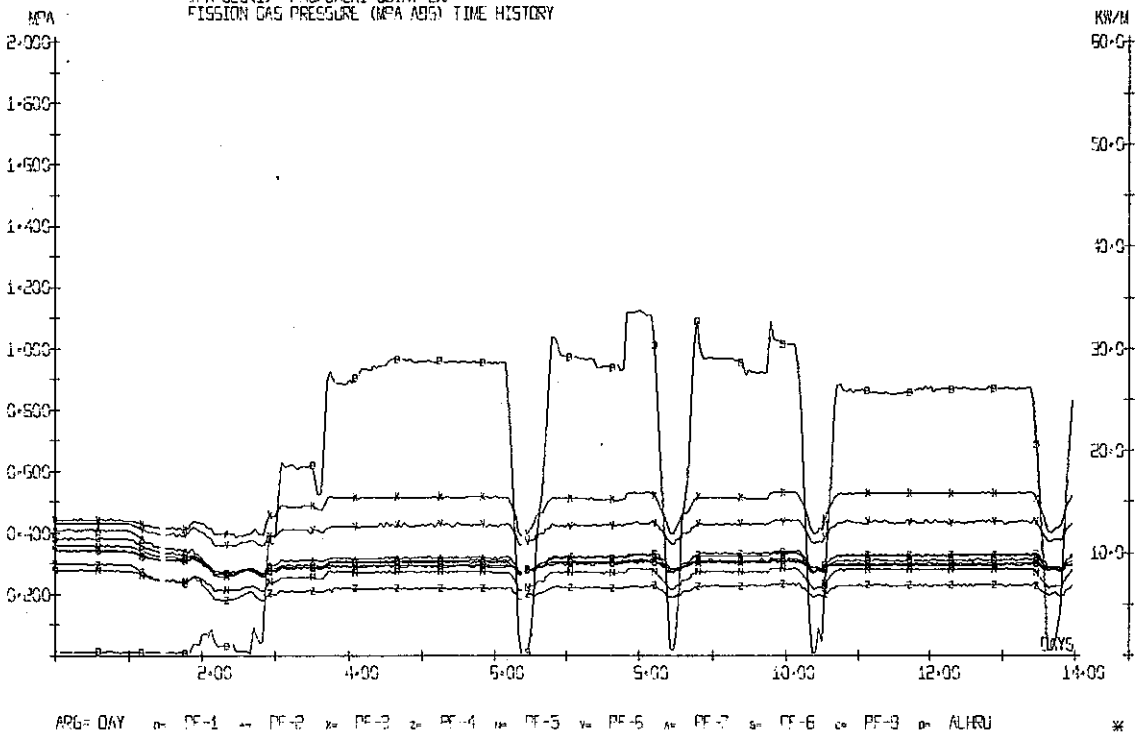

OECD HALDEN REACTOR PROJECT
 DATA FROM 15 SEPT 81 0 HRS TO 25 SEPT 81 23:00 HRS
 BURN-UP AT THE END OF FIRST/LAST DAY 5325 6320 MWD/T UGR

PLOT 132

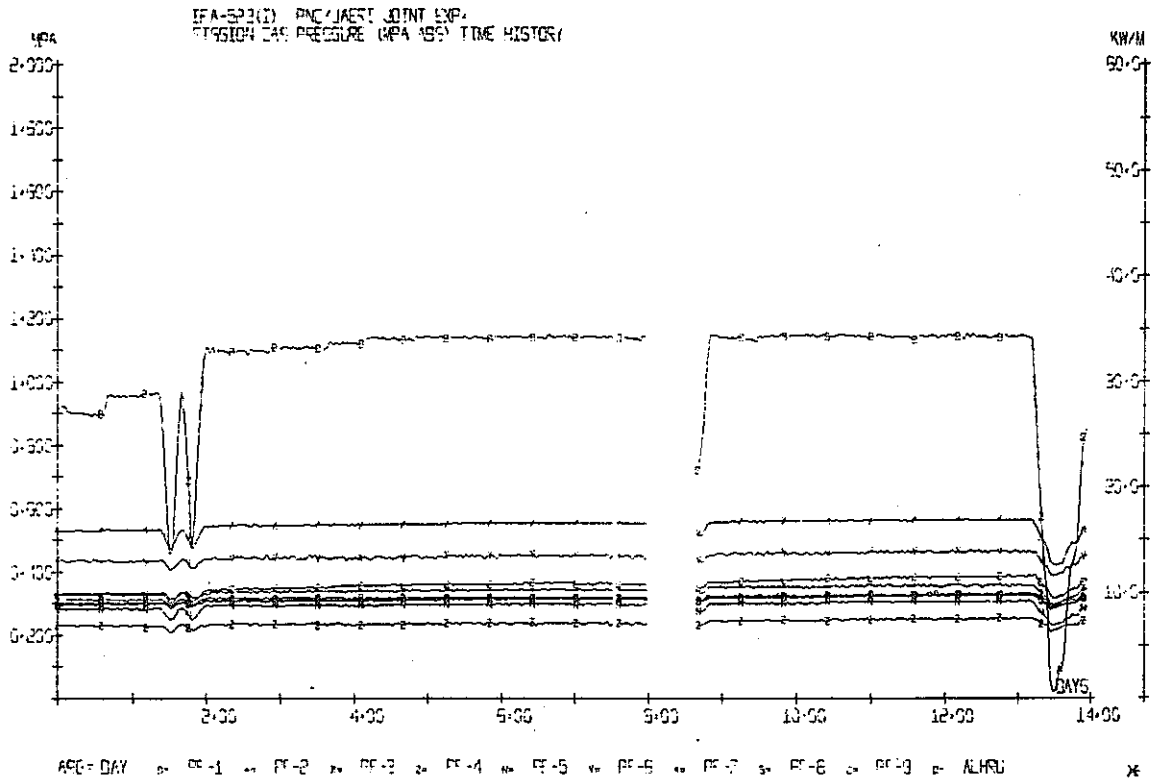

OECD HALDEN REACTOR PROJECT
 DATA FROM 29 SEPT 81 0 HRS TO 4 OCT 81 23:00 HRS
 BURN-UP AT THE END OF FIRST/LAST DAY 6362 6413 MWD/T UGR

PLOT 133

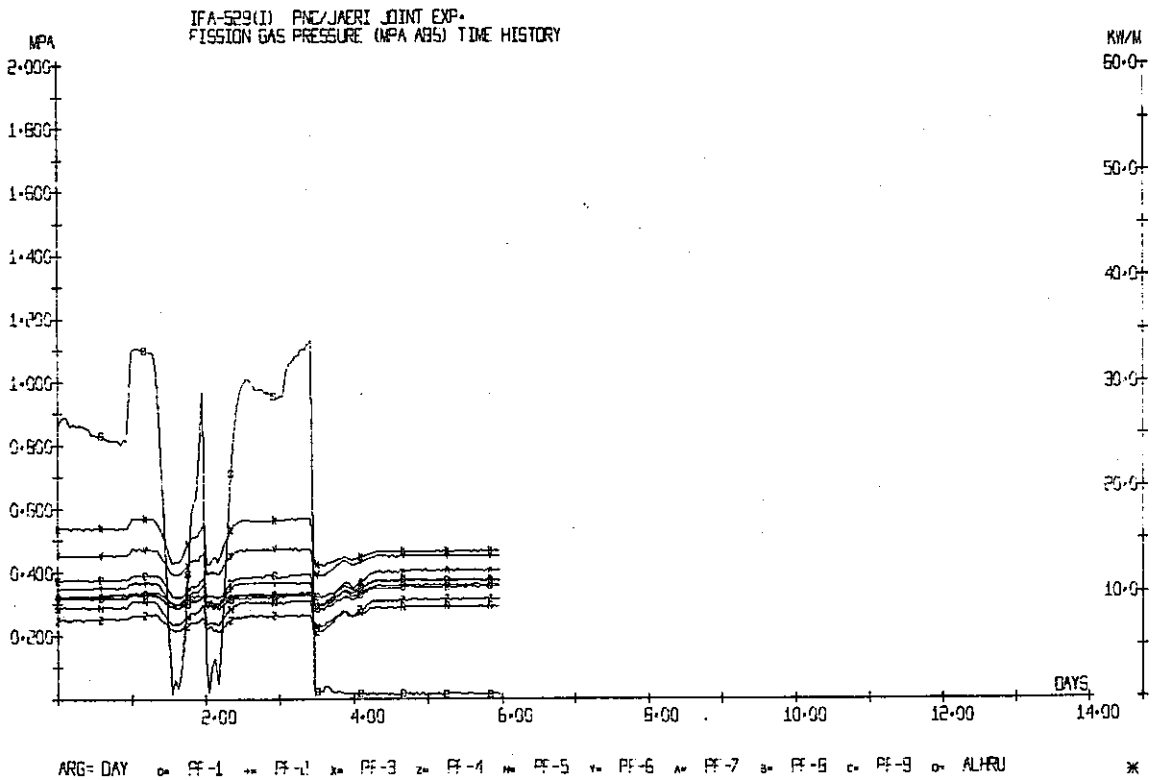

OECD HALDEN REACTOR PROJECT

DATA FROM 21 DEC 81 0:49S TO 31 DEC 81 23:44 HRS
 BURN-UP AT THE END OF FIRST/LAST DAY 6417 6525 MWD/T UO2

PLOT 132

IFA-523(2) PNC/JAERI JOINT EXP.
 FISSION GAS PRESSURE (MPA ABS) TIME HISTORY

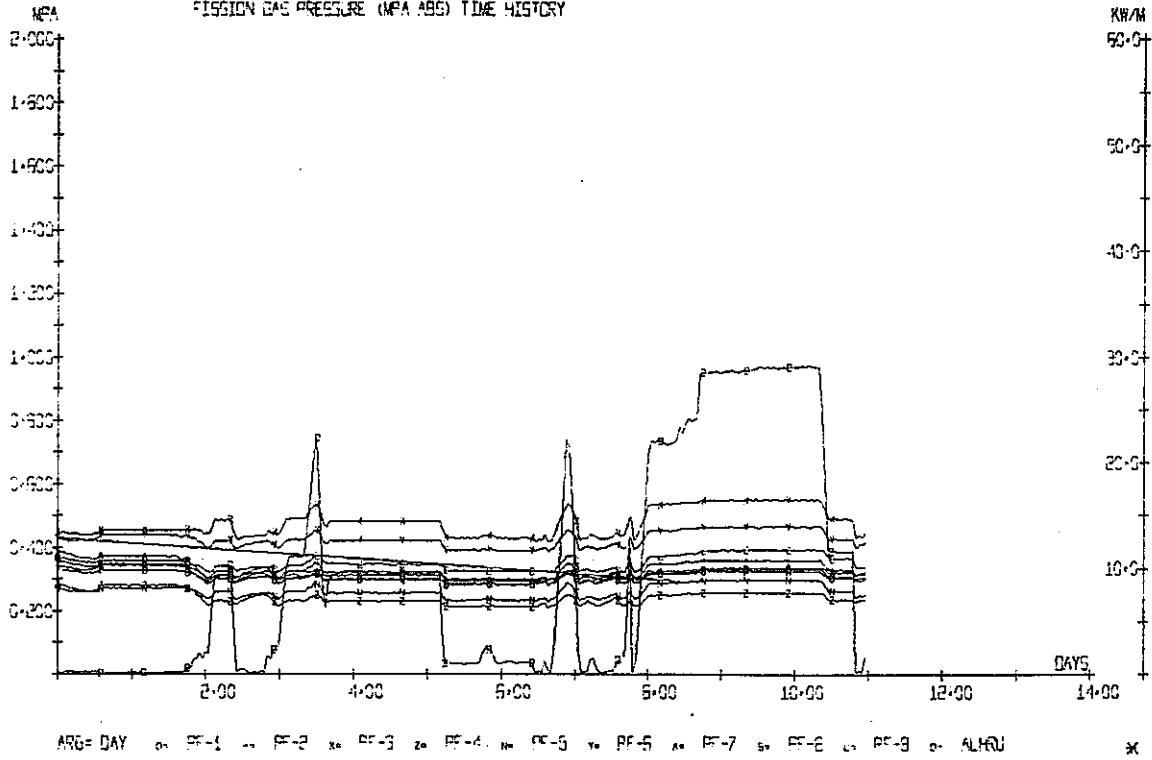

OECD HALDEN REACTOR PROJECT

DATA FROM 1 JAN 82 0:49S TO 14 JAN 82 23:44 HRS
 BURN-UP AT THE END OF FIRST/LAST DAY 6531 6651 MWD/T UO2

PLOT 132

IFA-523(2) PNC/JAERI JOINT EXP.
 FISSION GAS PRESSURE (MPA ABS) TIME HISTORY

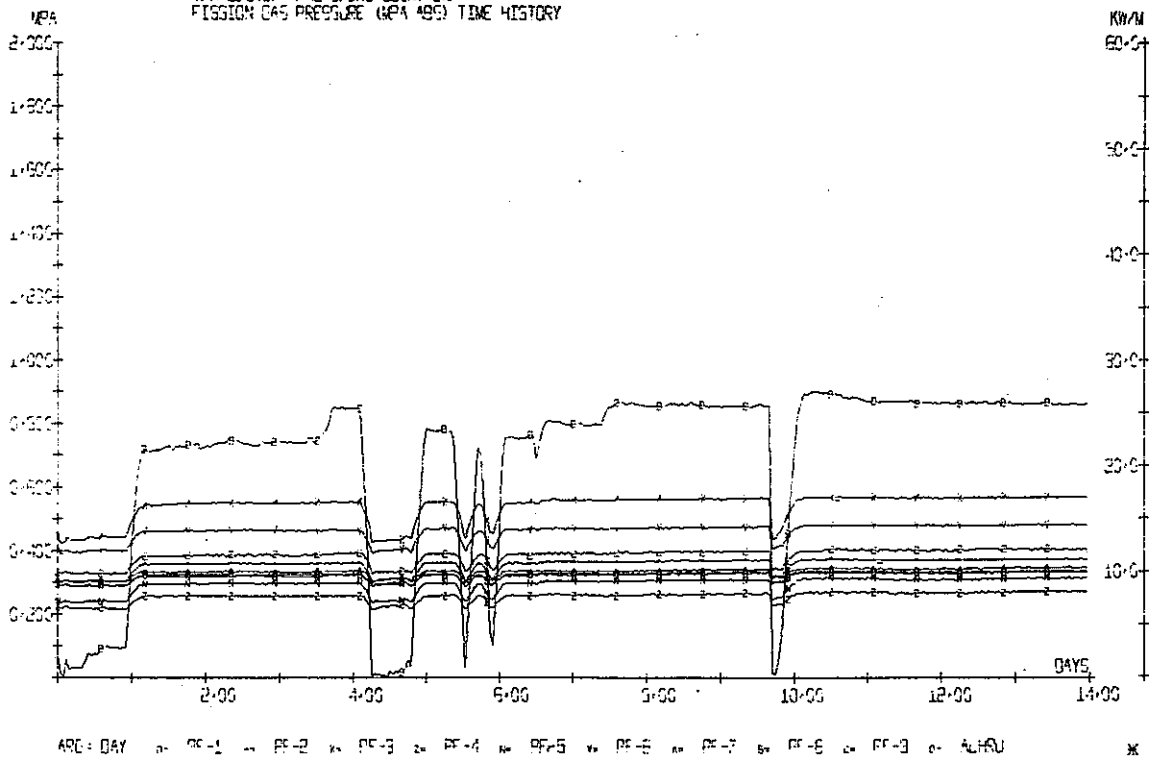

OECD HALDEN REACTOR PROJECT
 DATA FROM 15 JAN 82 0 HRS TO 25 JAN 82 23:45 HRS
 BURN-UP AT THE END OF FIRST/LAST DAY 5600 7621 MWDT UOE

PLOT 132

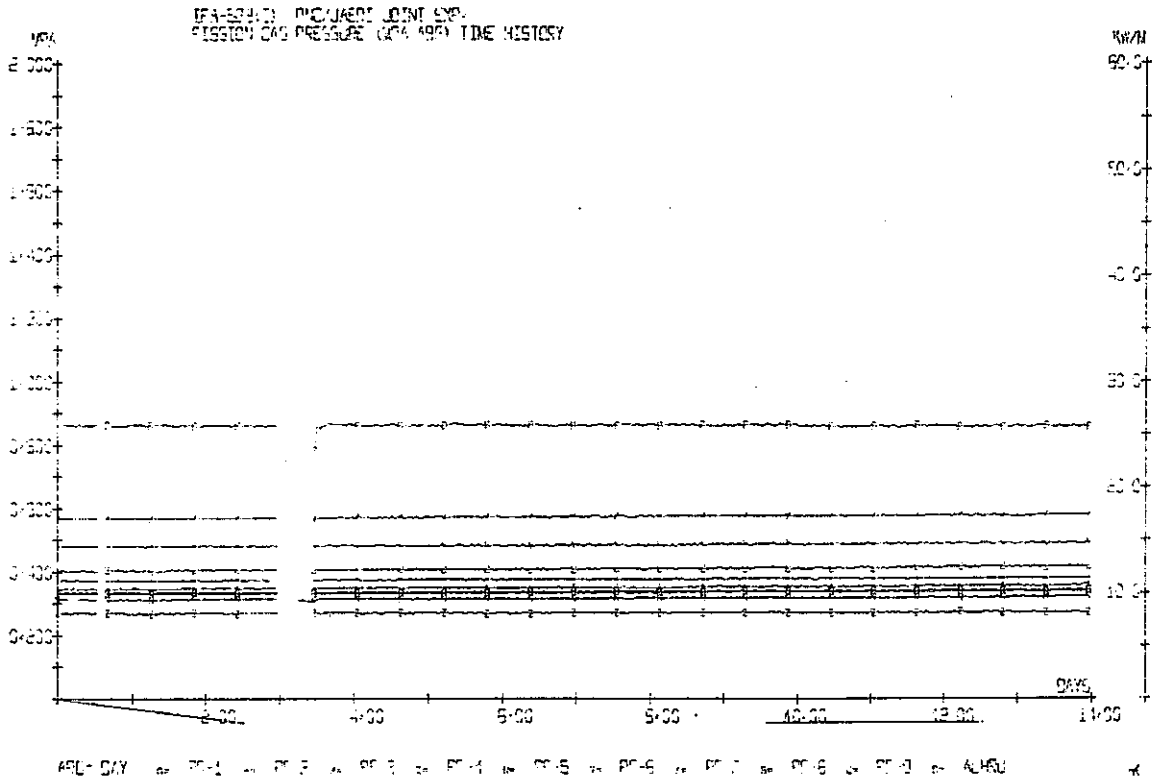

OECD HALDEN REACTOR PROJECT
 DATA FROM 31 JAN 82 0 HRS TO 13 FEB 82 23:45 HRS
 BURN-UP AT THE END OF FIRST/LAST DAY 7337 7617 MWDT UOE

PLOT 132

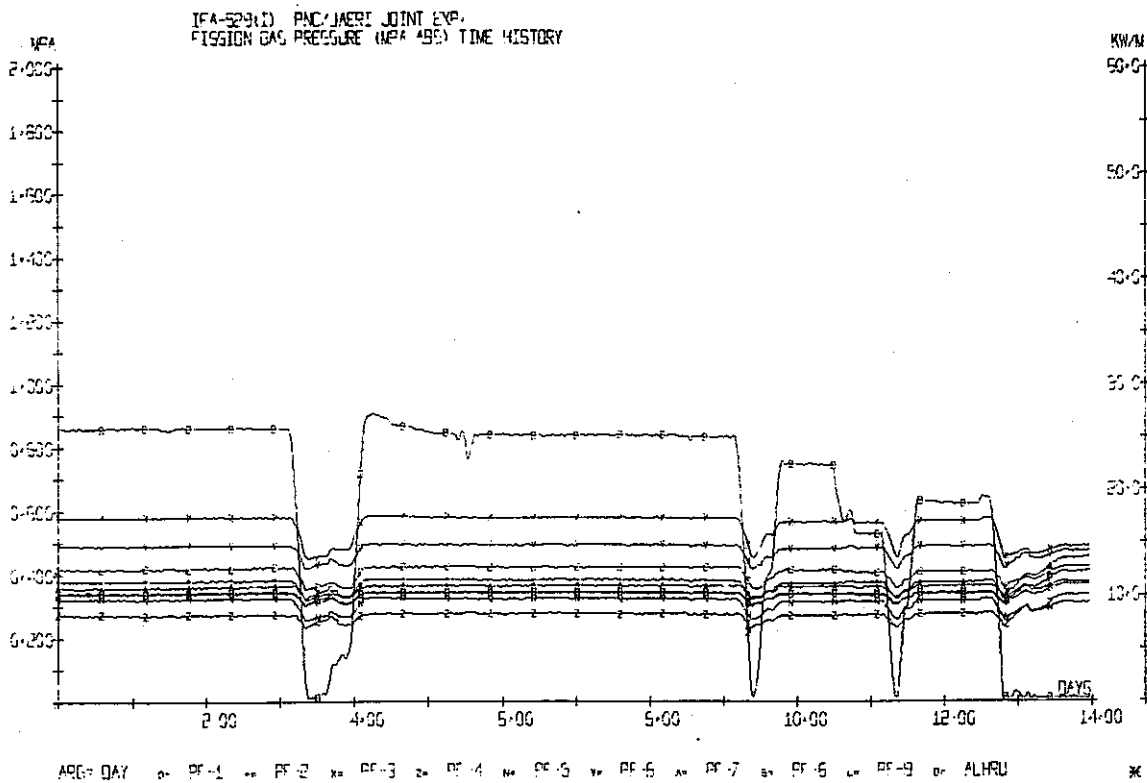

OECD HALDEN REACTOR PROJECT
 DATA FROM 29 FEB 92 0 HRS TO 13 MAR 92 23:45 HRS
 BURN-UP AT THE END OF FIRST/LAST DAY 2616 7573 MWDT UO2

PLOT 132

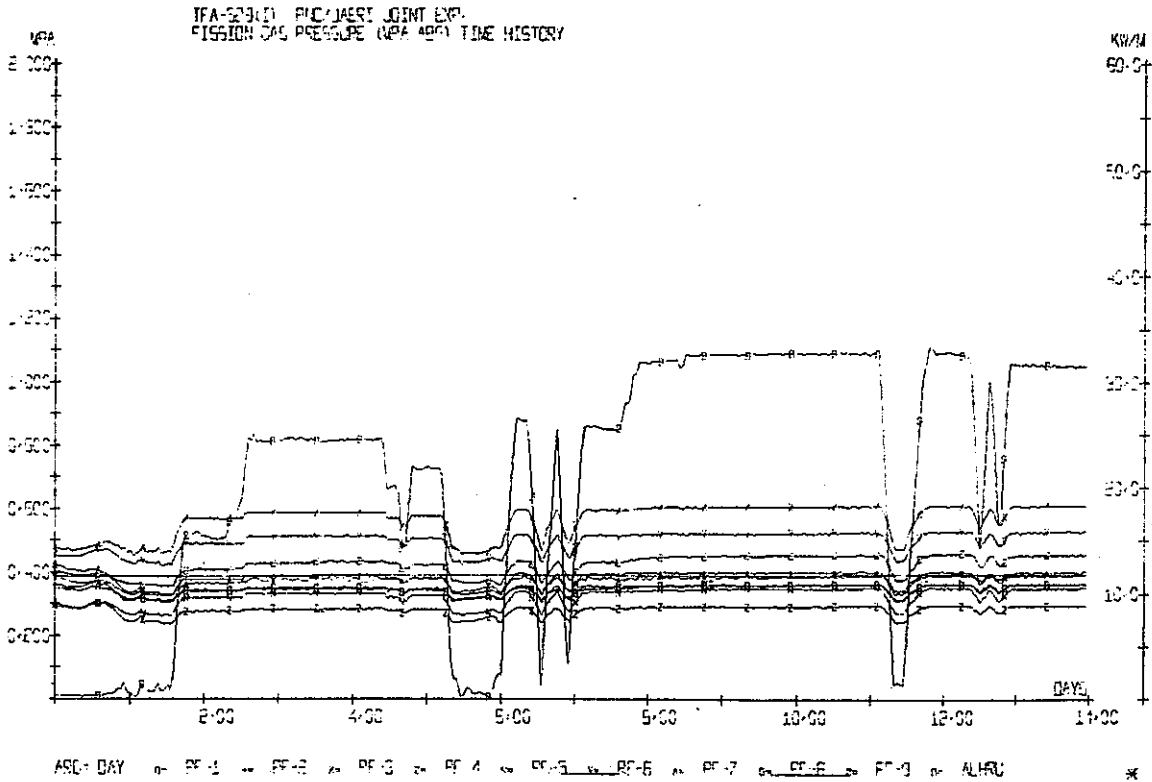

OECD HALDEN REACTOR PROJECT
 DATA FROM 11 MAR 92 0 HRS TO 24 MAR 92 23:45 HRS
 BURN-UP AT THE END OF FIRST/LAST DAY 7953 9271 MWDT UO2

PLOT 132

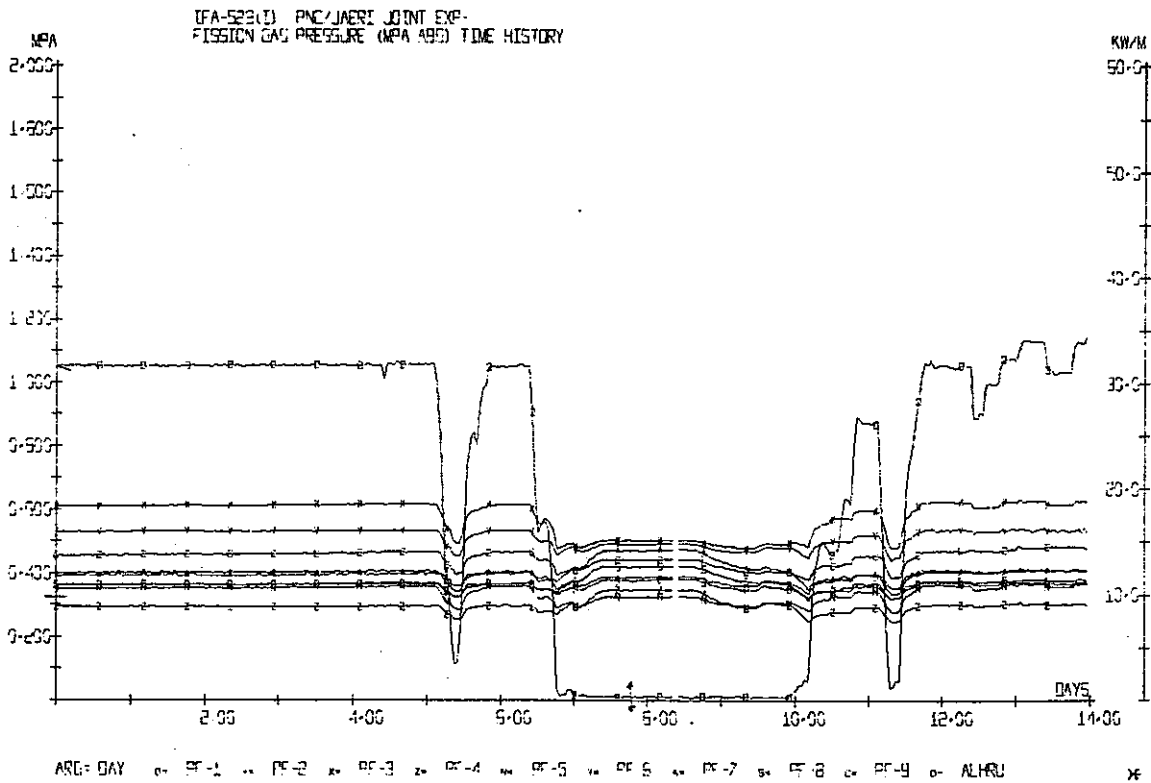

OECD HALDEN REACTOR PROJECT
 DATA FROM 25 MAR 82 0 HRS TO 31 MAR 82 23-59 HRS
 BURN-UP AT THE END OF FIRST/LAST DAY 8306 8511 MW/D UOZ

PLOT 132

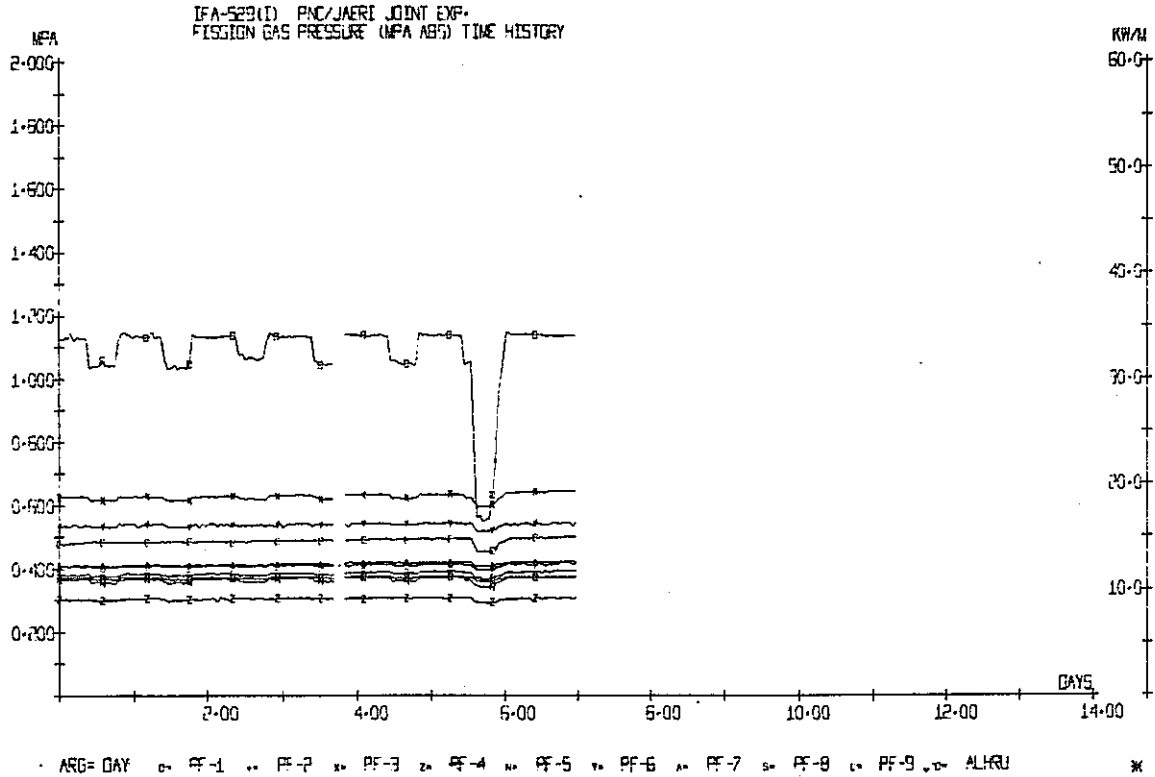

OECD HALDEN REACTOR PROJECT
 DATA FROM 1 APR 82 0 HRS TO 13 APR 82 23-59 HRS
 BURN-UP AT THE END OF FIRST/LAST DAY 8526 8746 MW/D UOZ

PLOT 132

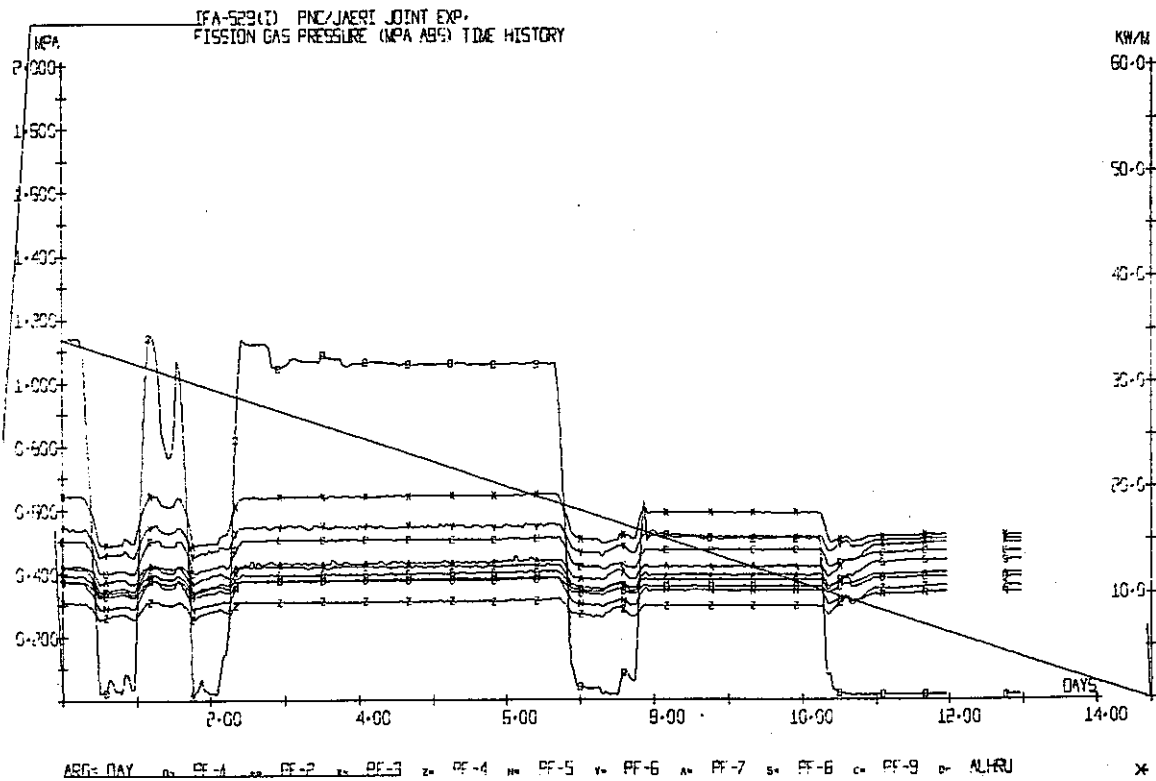

OECD HALDEN REACTOR PROJECT
 DATA FROM 15 MAY 82 0 HRS TO 1 JUNE 82 2345 HRS
 BURN-UP AT THE END OF FIRST/LAST DAY 5213 5433 MWDT UO2

PLOT 132

IFA-529(I) PNC/JAERI JOINT EXP.
 FISSION GAS PRESSURE (MPA ABS) TIME HISTORY

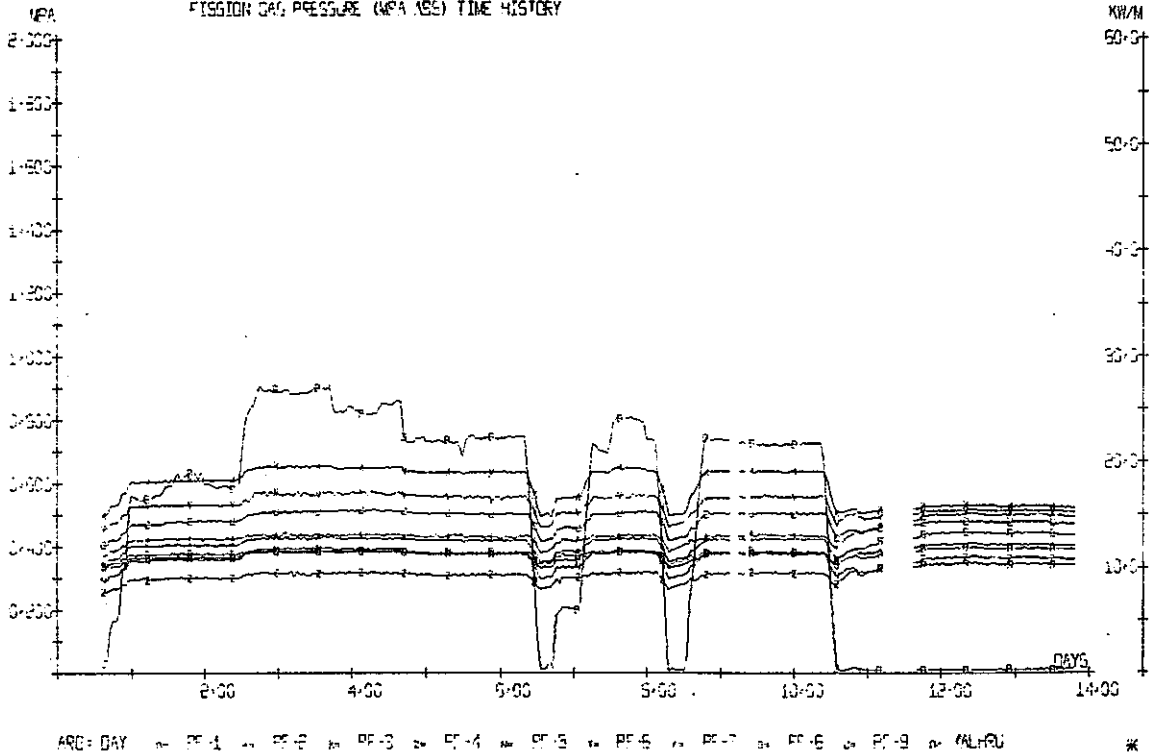

OECD HALDEN REACTOR PROJECT
 DATA FROM 15 JUNE 82 0 HRS TO 27 JUNE 82 2345 HRS
 BURN-UP AT THE END OF FIRST/LAST DAY 8512 9738 MWDT UO2

PLOT 132

IFA-529(I) PNC/JAERI JOINT EXP.
 FISSION GAS PRESSURE (MPA ABS) TIME HISTORY

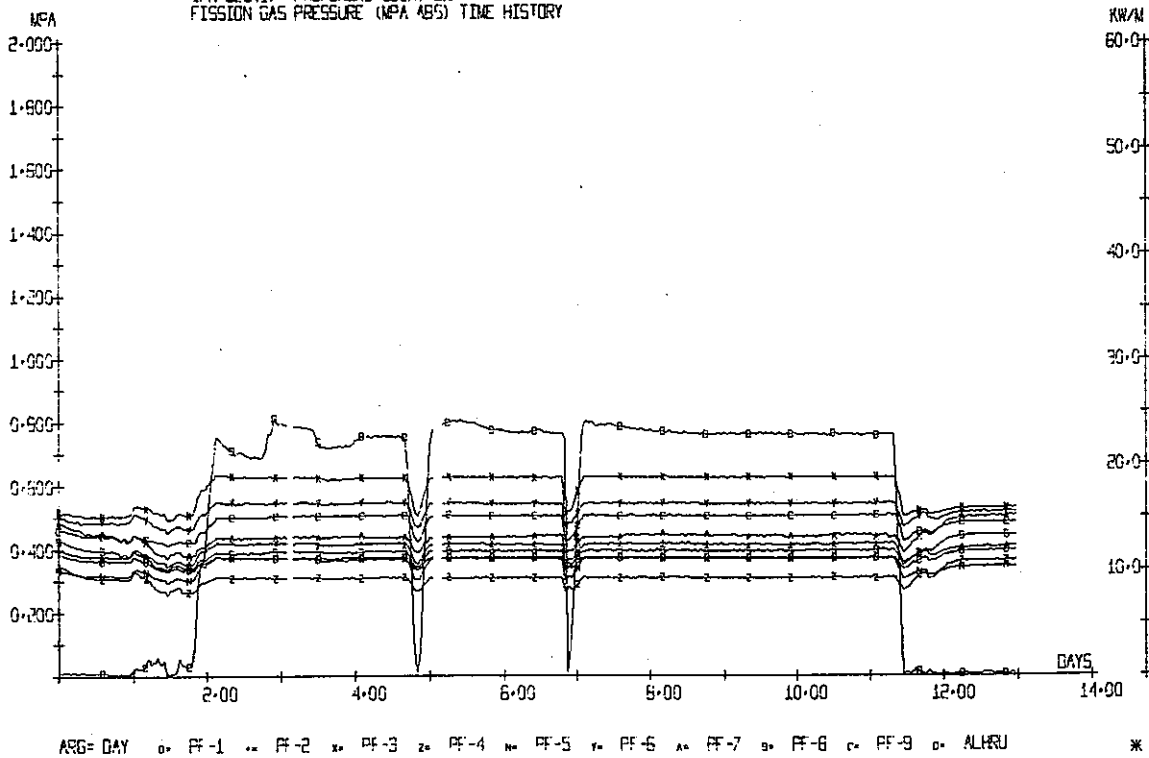

OECD HALDEN REACTOR PROJECT
 DATA FROM 1 JULY82 0 HRS TO 14 JULY82 2300 HRS
 BURN-UP AT THE END OF FIRST/LAST DAY 5734 6664 MWDT UO2

PLOT 132

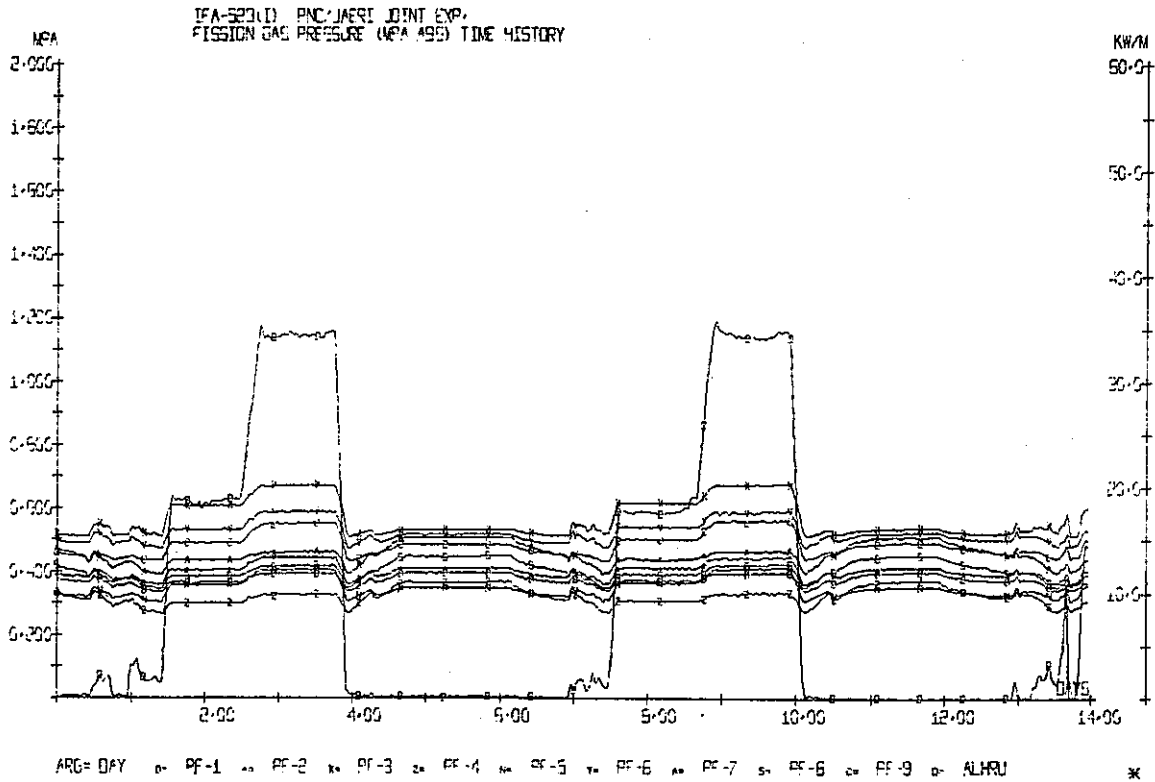

OECD HALDEN REACTOR PROJECT
 DATA FROM 15 JULY82 0 HRS TO 29 JULY82 2300 HRS
 BURN-UP AT THE END OF FIRST/LAST DAY 8903 9109 MWDT UO2

PLOT 132

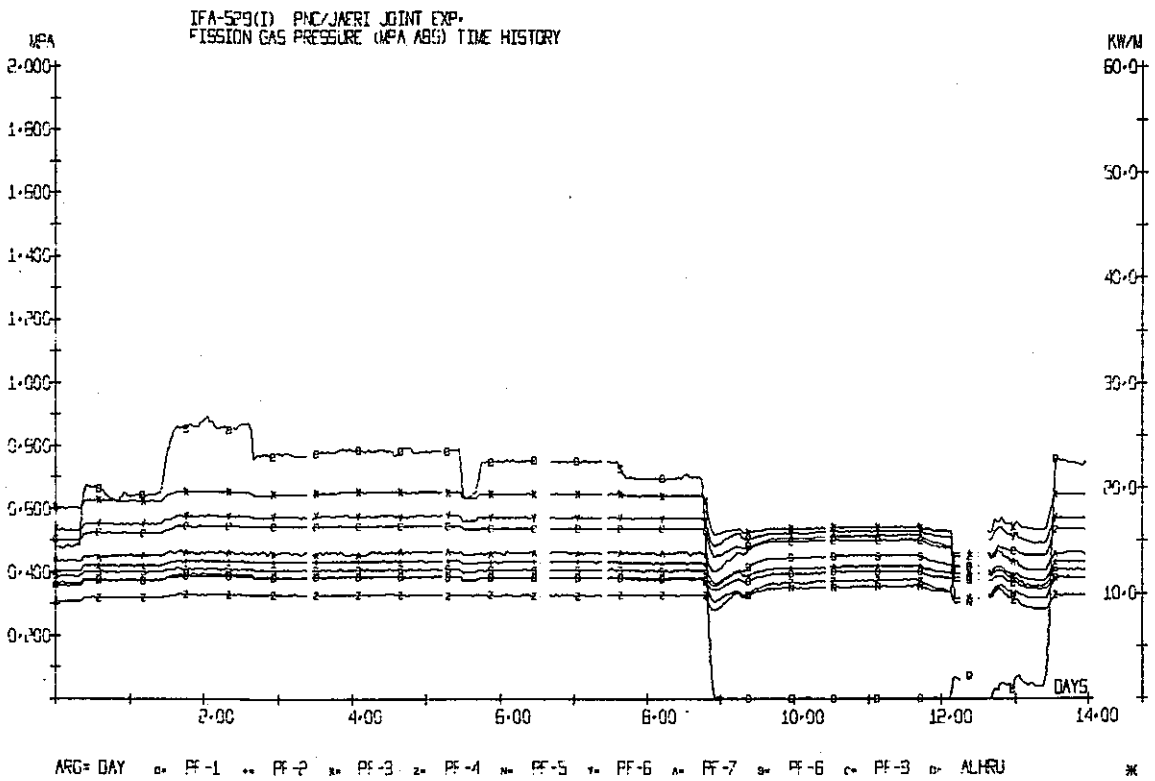

OECD HALDEN REACTOR PROJECT
 DATA FROM 29 JULY 82 0 HRS TO 7 AUG 82 2300 HRS
 BURN-UP AT THE END OF FIRST/LAST DAY 9135 9152 MWDT UO2

PLOT 132

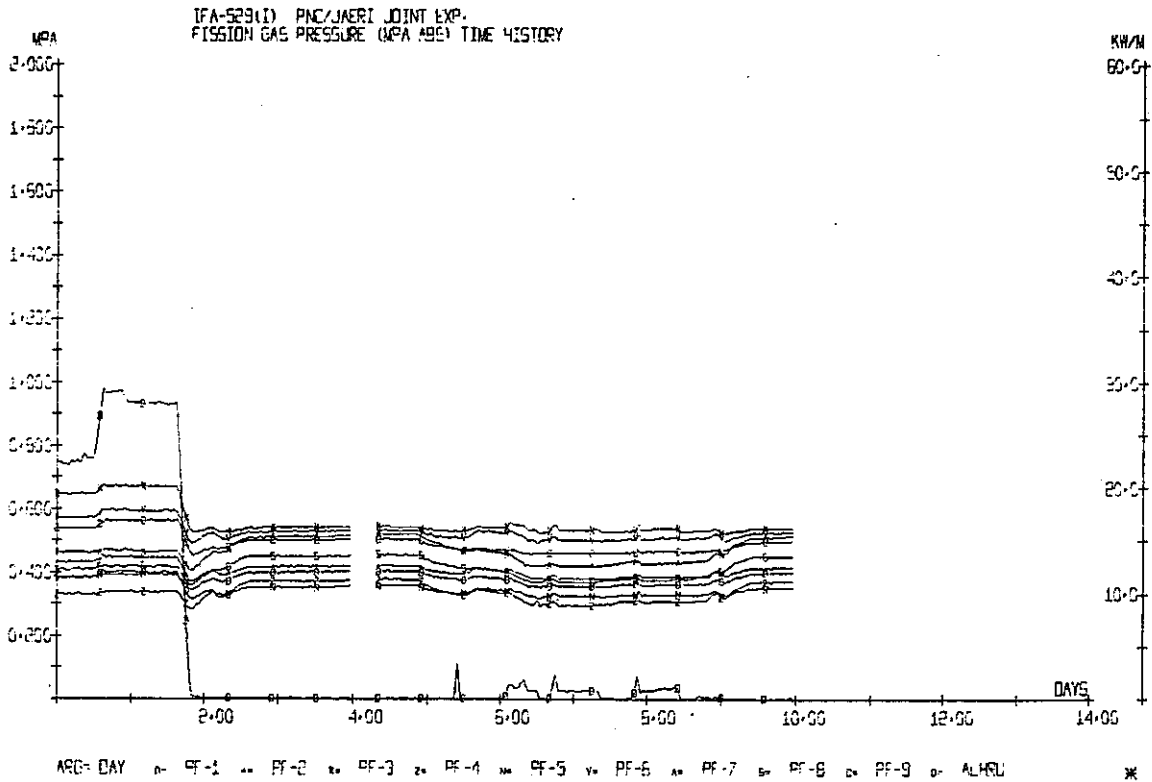

OECD HALDEN REACTOR PROJECT
 DATA FROM 12 AUG 82 0 HRS TO 21 AUG 82 2300 HRS
 BURN-UP AT THE END OF FIRST/LAST DAY 9153 9305 MWDT UO2

PLOT 132

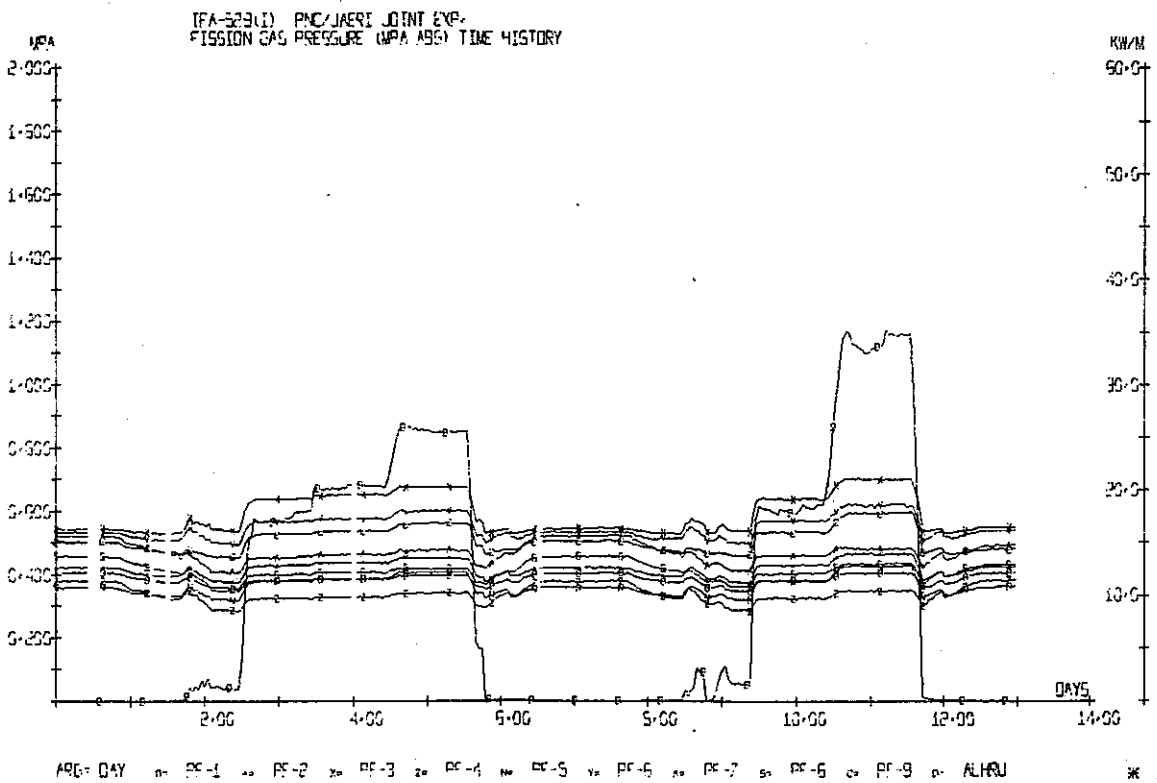

OECD HALDEN REACTOR PROJECT
 DATA FROM 19 SEPT 62 0 HRS TO 30 SEPT 62 2300 HRS
 BURN-UP AT THE END OF FIRST/LAST DAY 9306 9486 MW/D/T UO2

PLOT 132

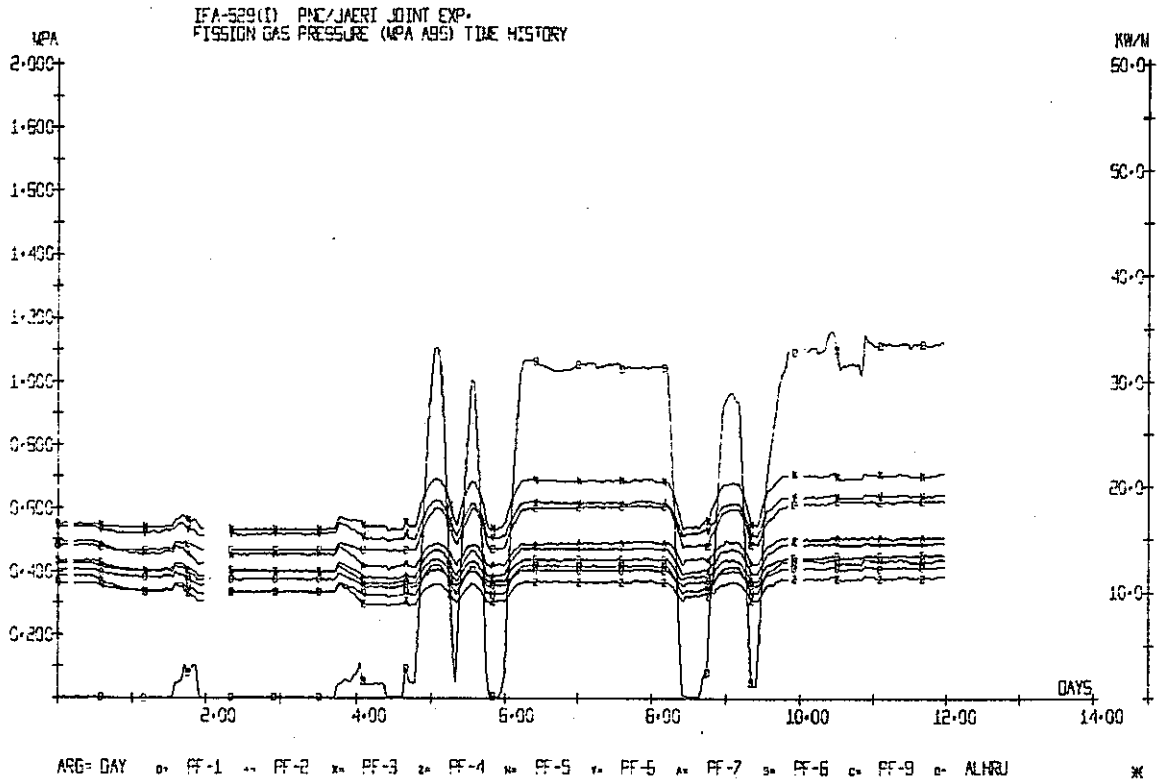

OECD HALDEN REACTOR PROJECT
 DATA FROM 1 OCT 62 0 HRS TO 14 OCT 62 2300 HRS
 BURN-UP AT THE END OF FIRST/LAST DAY 9530 9842 MW/D/T UO2

PLOT 132

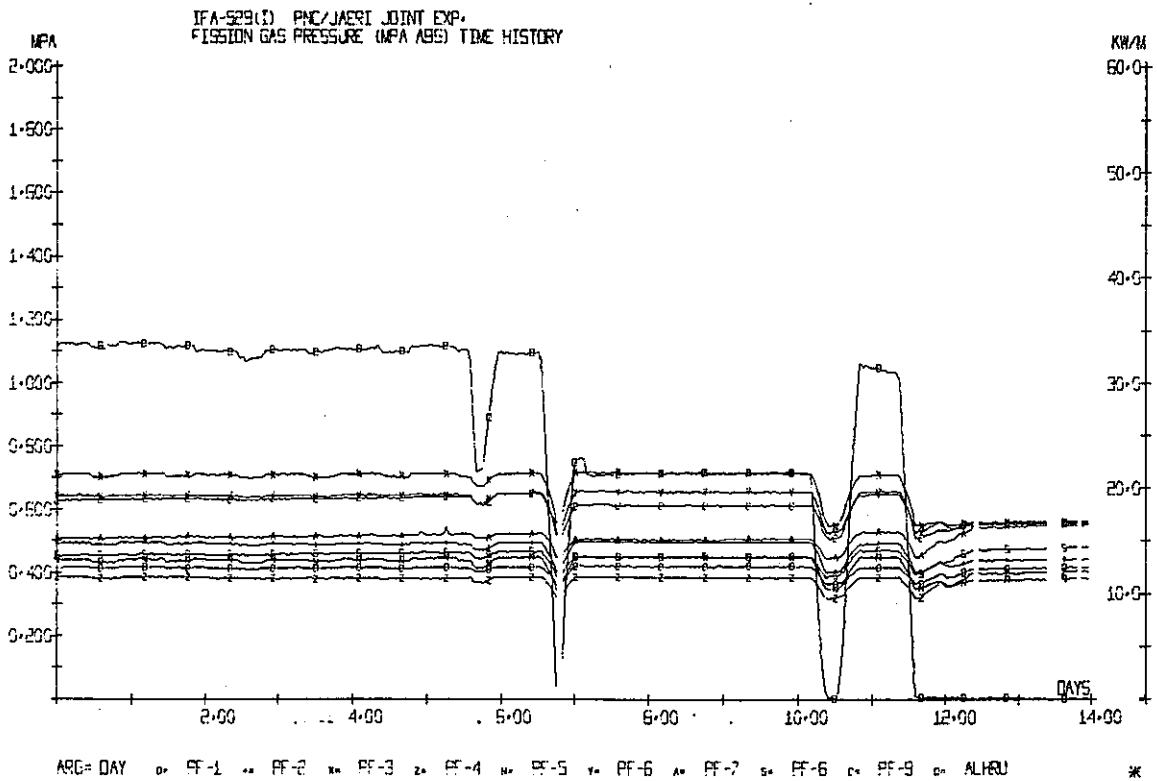

GEEO HALDEN REACTOR PROJECT
 DATA FROM 15 OCT 62 0 HRS TO 25 OCT 62 2300 HRS
 BURN-UP AT THE END OF FIRST/LAST DAY 95-2 10013 MWDT 102

PLOT 132

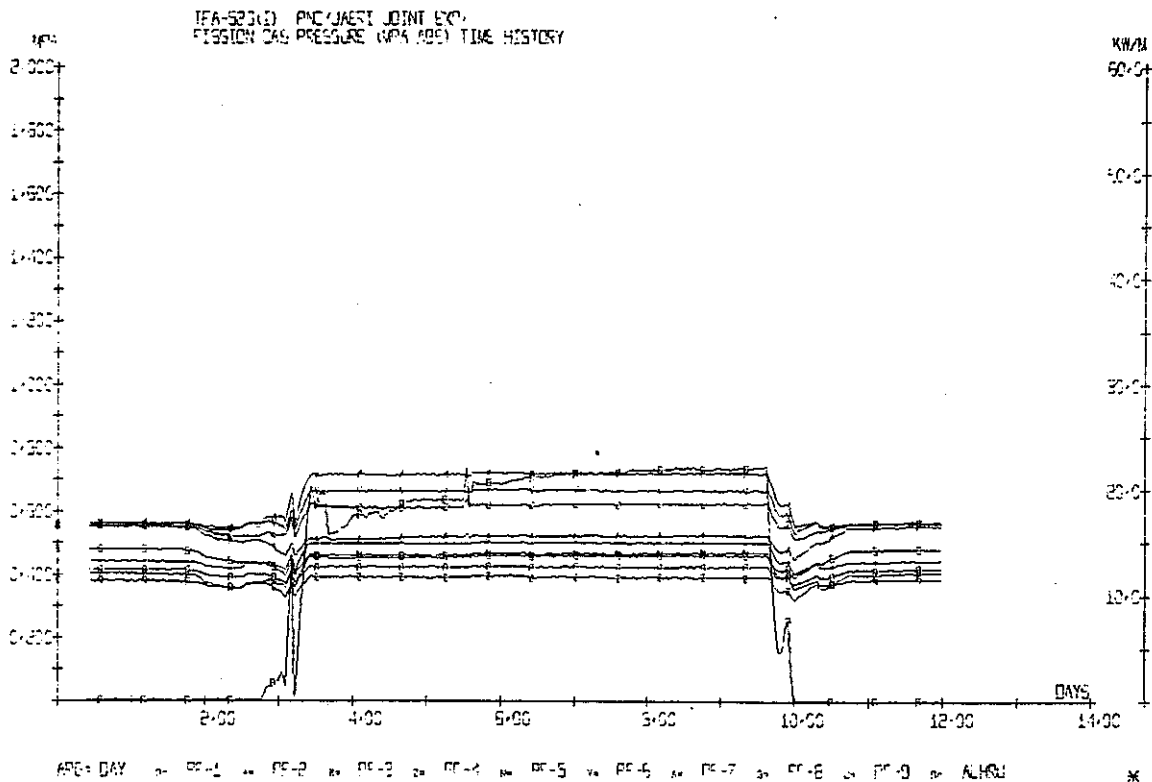

GEEO HALDEN REACTOR PROJECT
 DATA FROM 5 NOV 62 0 HRS TO 20 NOV 62 2300 HRS
 BURN-UP AT THE END OF FIRST/LAST DAY 10013 10216 MWDT 102

PLOT 132

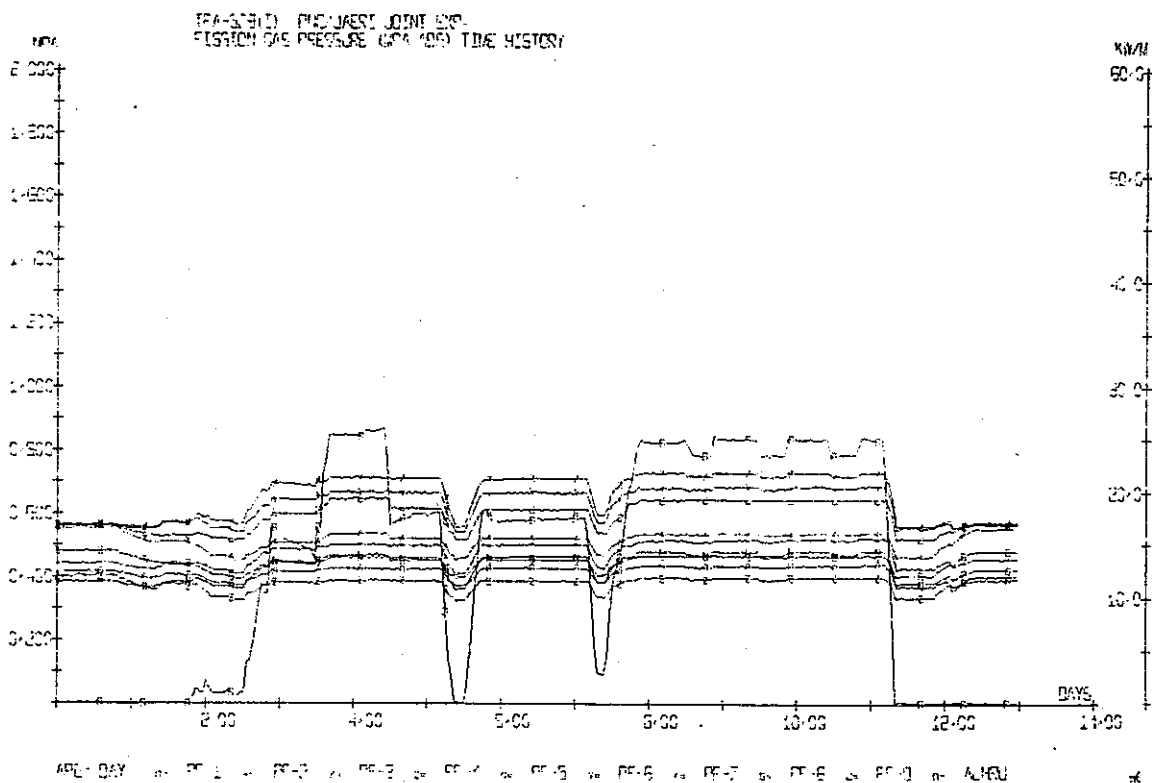

OECD HALDEN REACTOR PROJECT
 DATA FROM 24 NOV 62 0 HRS TO 7 DEC 62 2300 HRS
 BURN-UP AT THE END OF FIRST/LAST DAY 10246 10275 MWDT UO2

PLOT 132

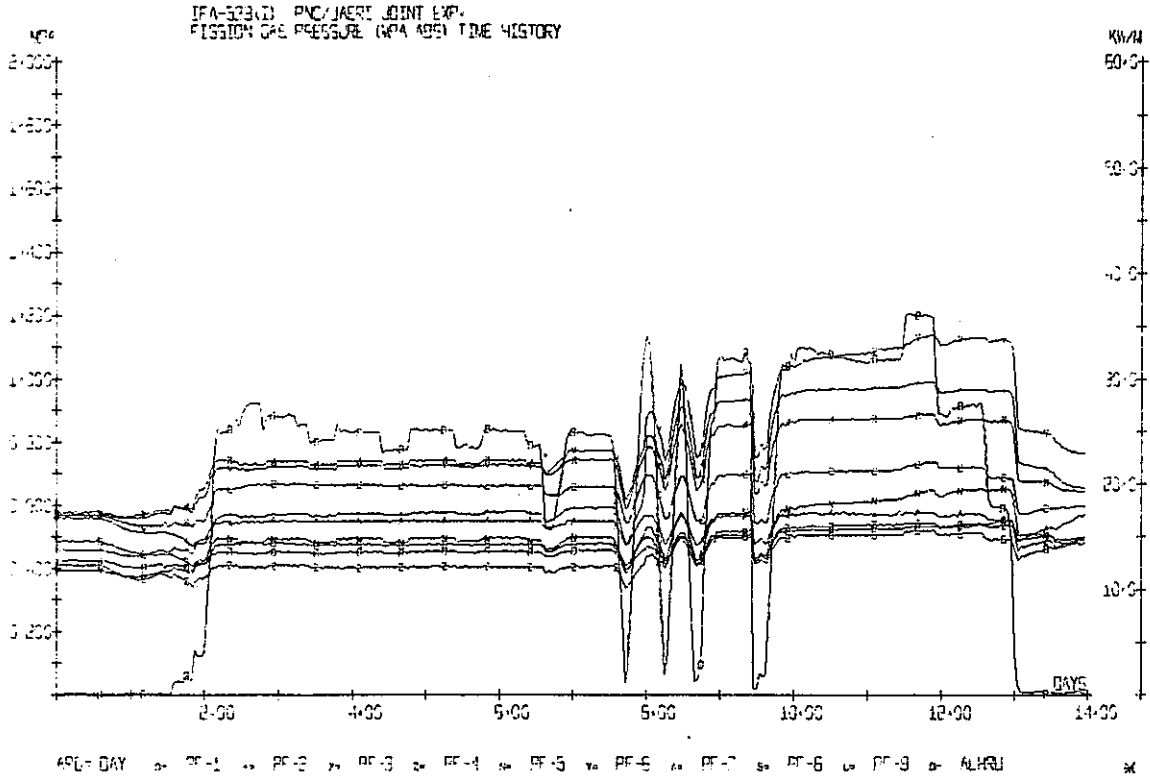

OECD HALDEN REACTOR PROJECT
 DATA FROM 16 DEC 62 0 HRS TO 31 DEC 62 2300 HRS
 BURN-UP AT THE END OF FIRST/LAST DAY 10581 10617 MWDT UO2

PLOT 132

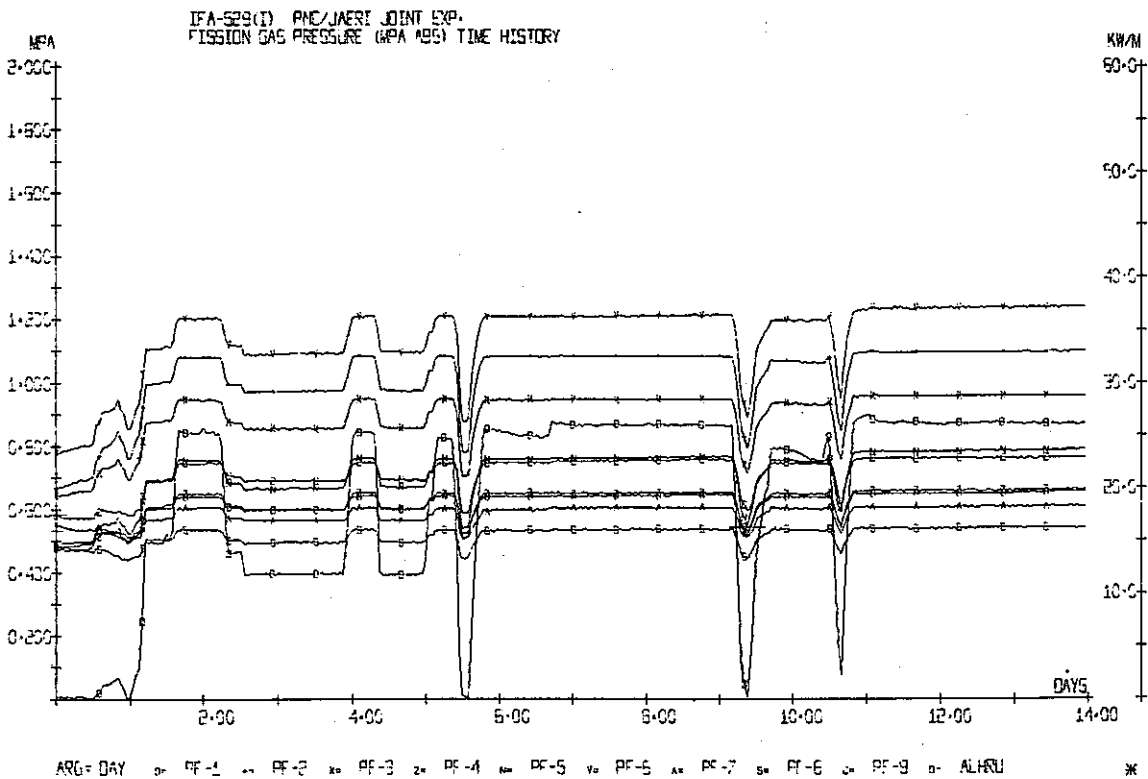

付 録 5

I F A - 529 計 装 デ ー タ

～ E C (被 覆 管 伸 び) デ ー タ ～

ロッド7, ロッド9, ロッド10, ロッド11

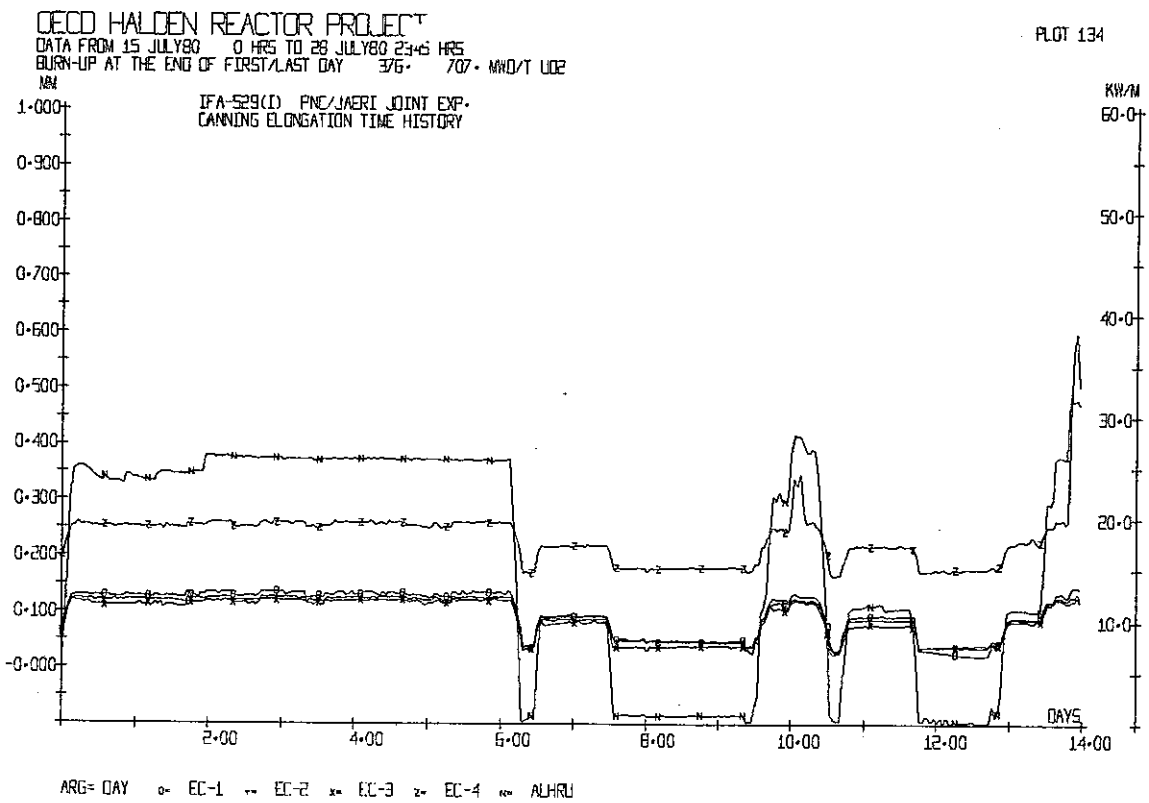
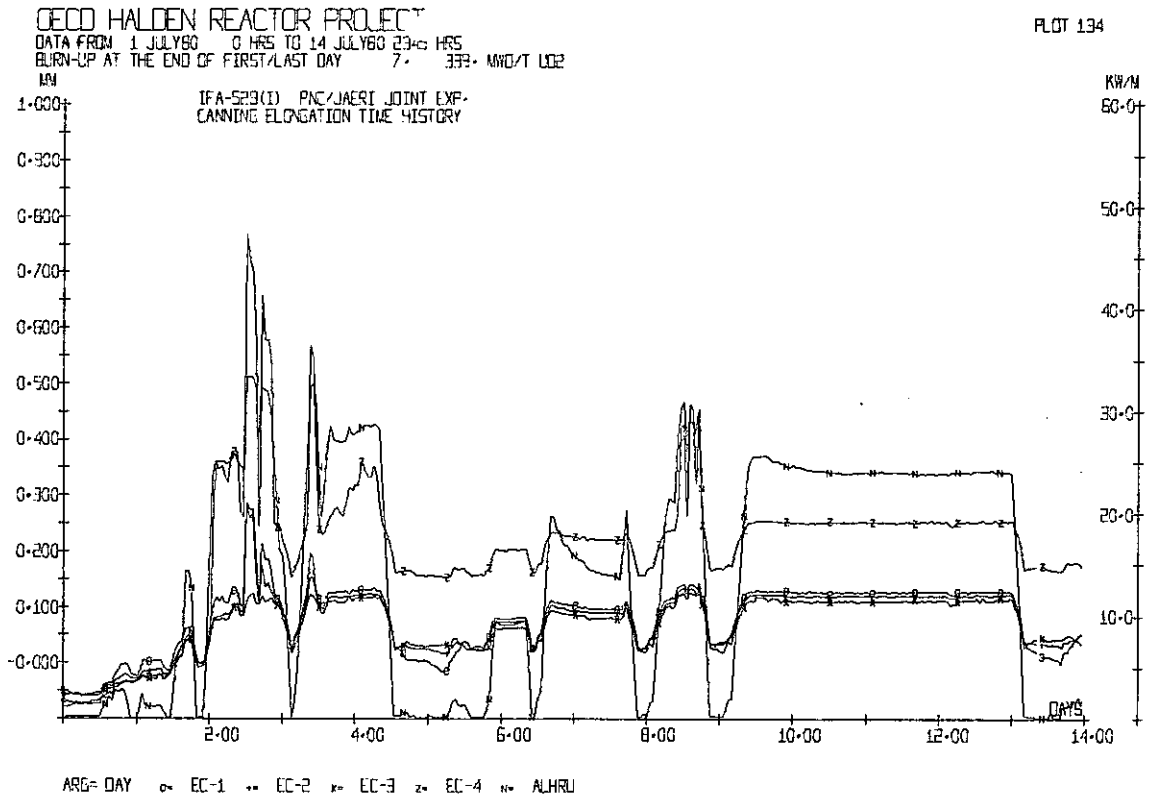

OECD HALDEN REACTOR PROJECT
 DATA FROM 29 JULY 80 0 HRS TO 11 AUG 80 23:45 HRS
 BURN-UP AT THE END OF FIRST/LAST DAY 735. 1131. MW/D/T UO2

PLOT 134

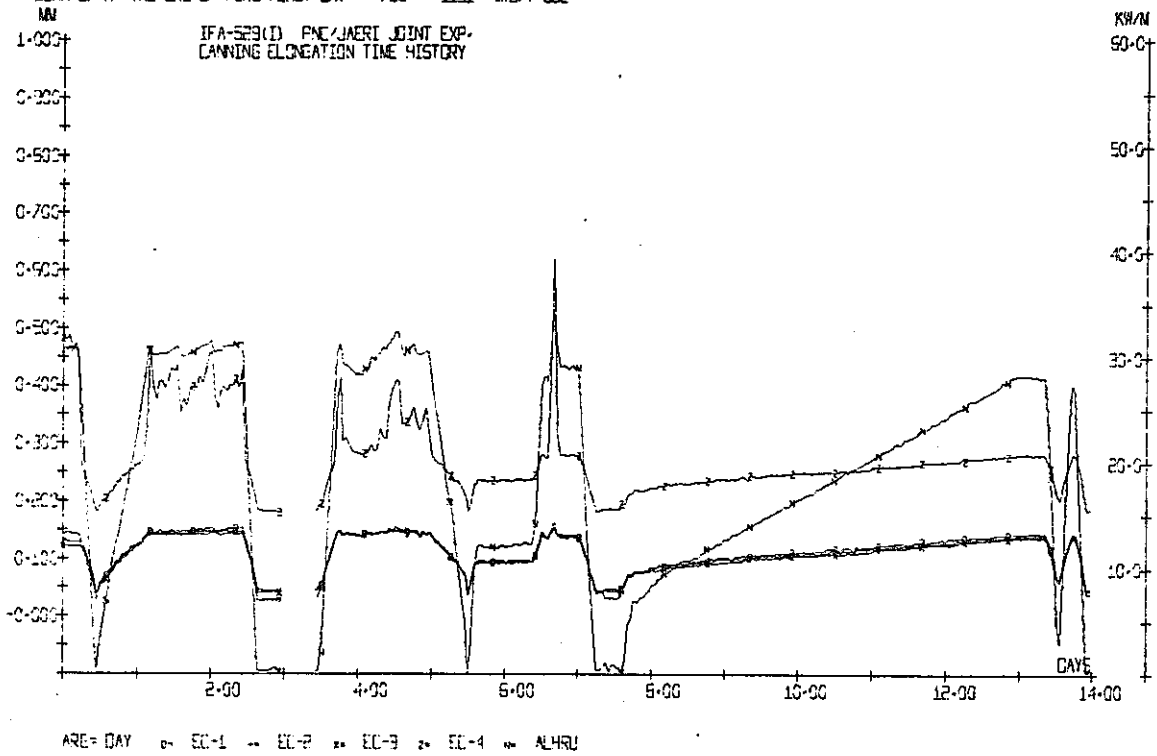

OECD HALDEN REACTOR PROJECT
 DATA FROM 12 AUG 80 0 HRS TO 17 AUG 80 23:45 HRS
 BURN-UP AT THE END OF FIRST/LAST DAY 1173. 1281. MW/D/T UO2

PLOT 134

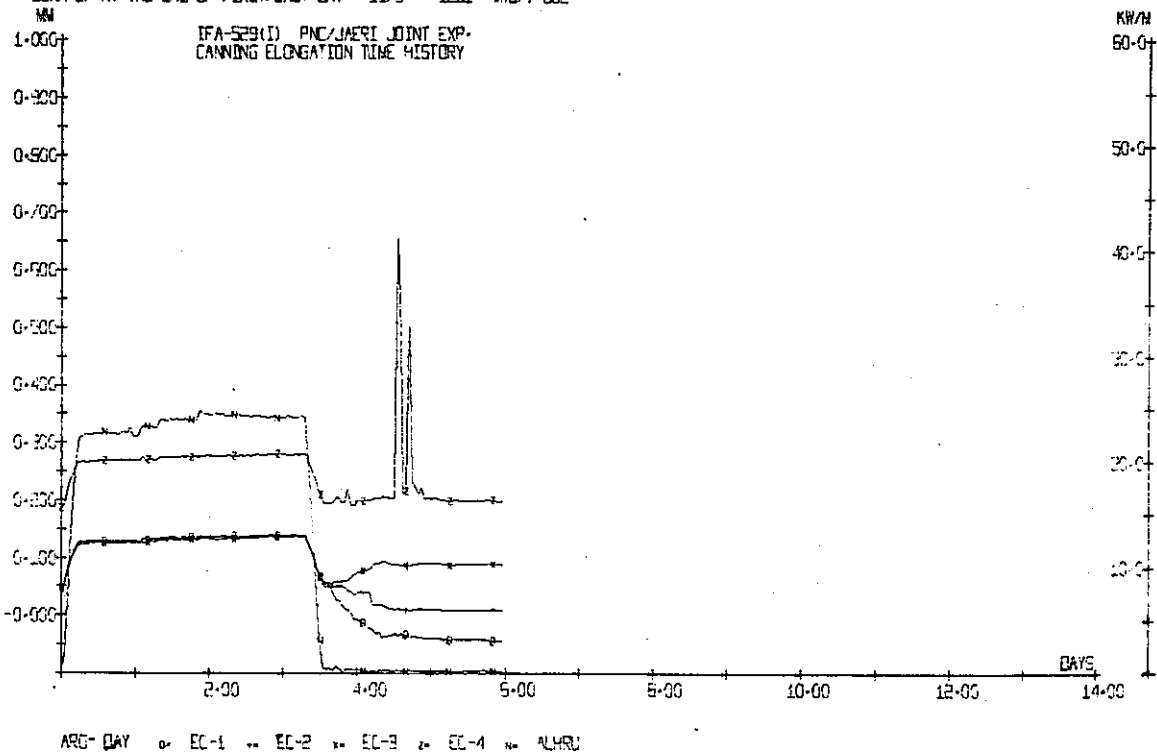

OECD HALDEN REACTOR PROJECT

DATA FROM 10 SEPT80 0 HRS TO 23 SEPT80 23:45 HRS
 BURN-UP AT THE END OF FIRST/LAST DAY 251 1272 MWDT UO2

PLOT 134

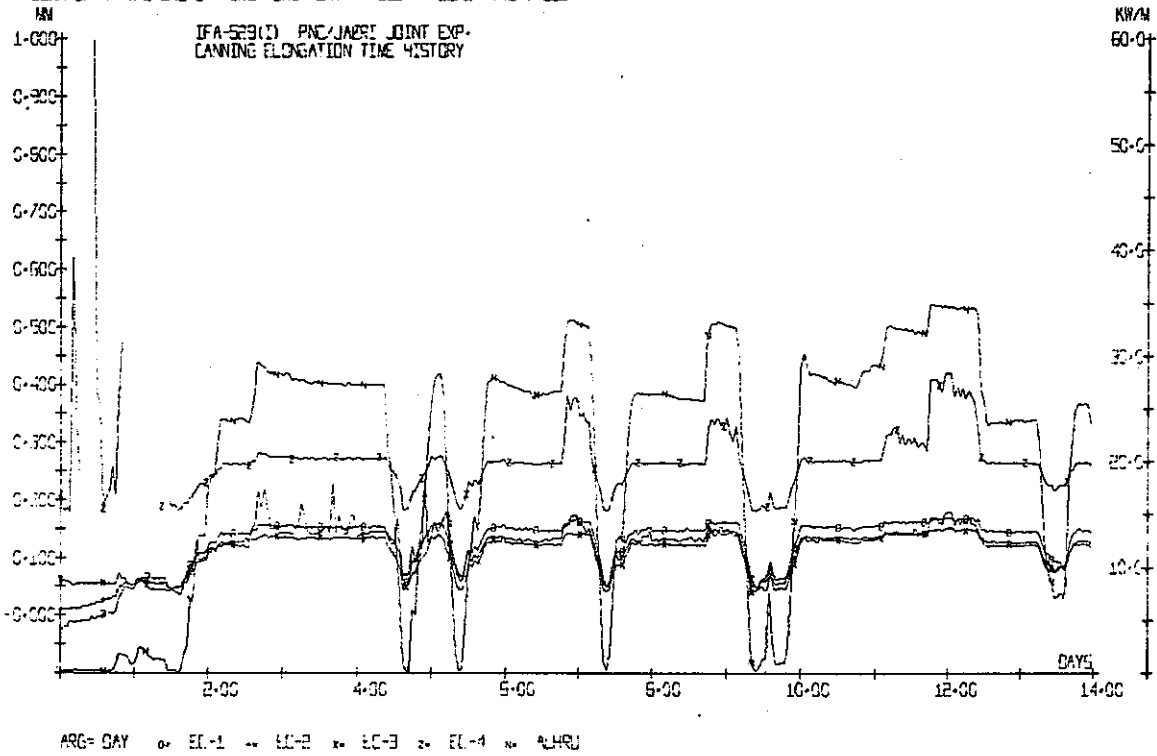

*

OECD HALDEN REACTOR PROJECT

DATA FROM 24 SEPT80 0 HRS TO 30 SEPT80 23:45 HRS
 BURN-UP AT THE END OF FIRST/LAST DAY 1284 1411 MWDT UO2

PLOT 134

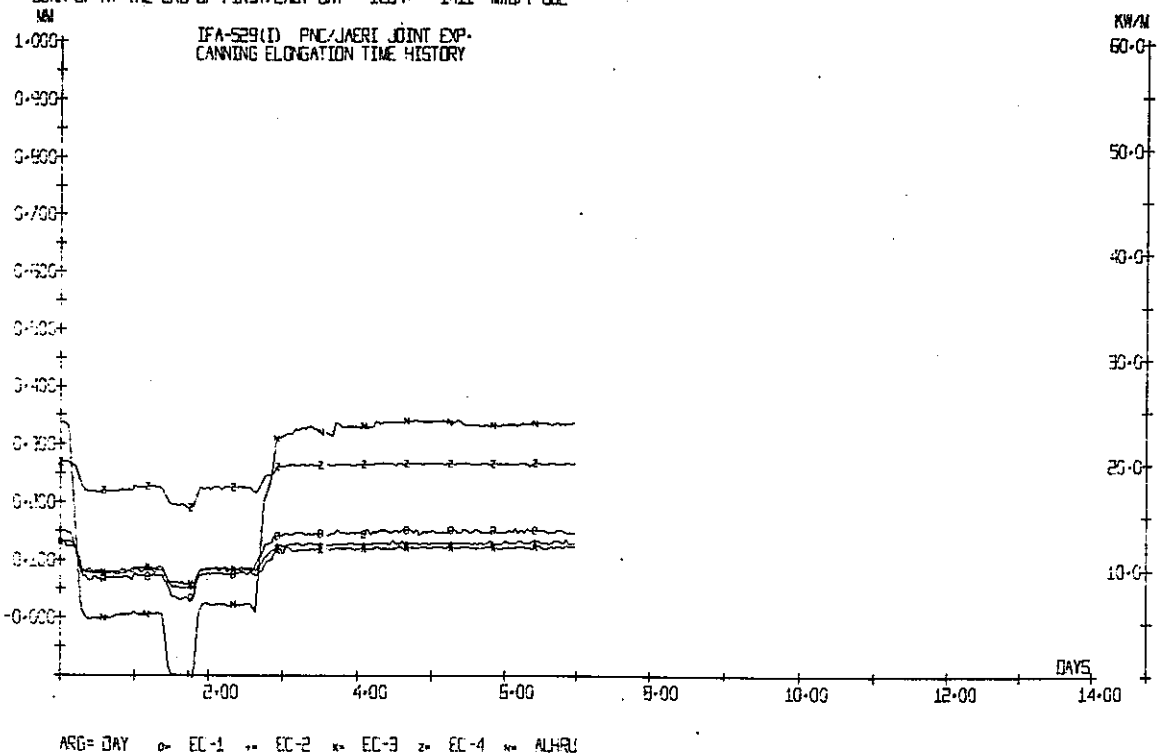

*

OECD HALDEN REACTOR PROJECT
 DATA FROM 1 OCT 80 0 HRS TO 5 OCT 80 2345 HRS
 BURN-UP AT THE END OF FIRST/LAST DAY 1.433 1.476 MW/D/T UO₂

PLOT 134

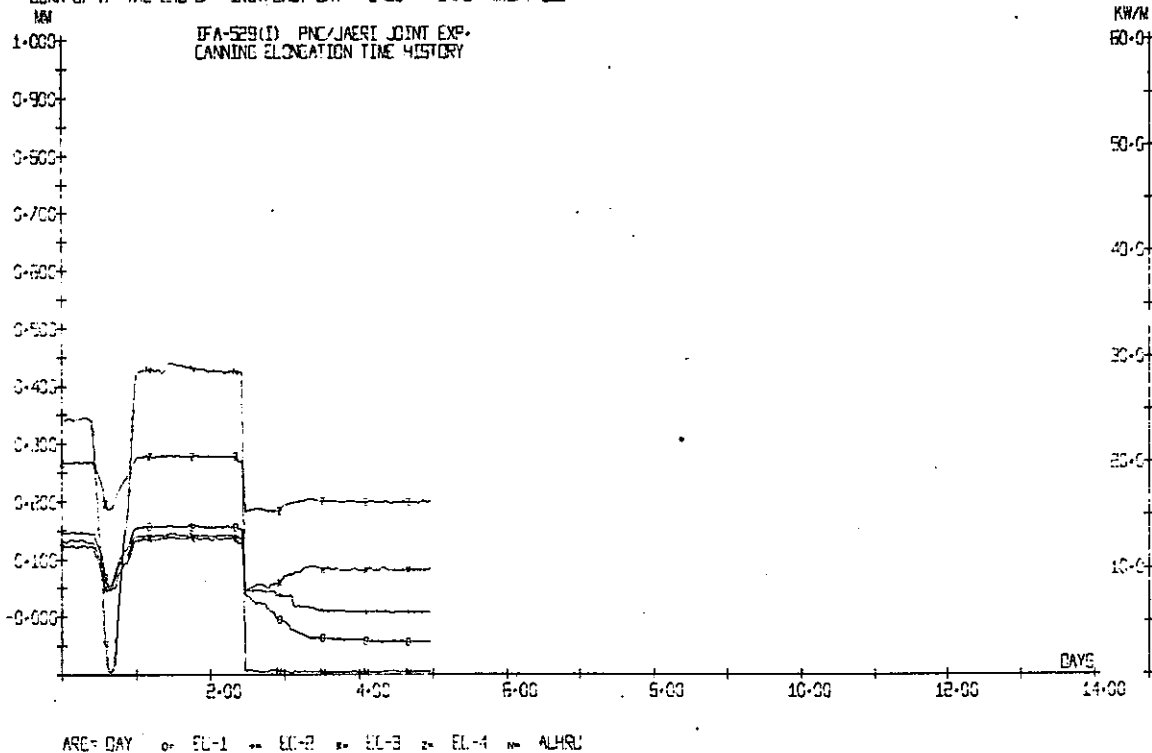

*

OECD HALDEN REACTOR PROJECT
 DATA FROM 12 DEC 80 0 HRS TO 23 DEC 80 1800 HRS
 BURN-UP AT THE END OF FIRST/LAST DAY 1.481 1.700 MW/D/T UO₂

PLOT 134

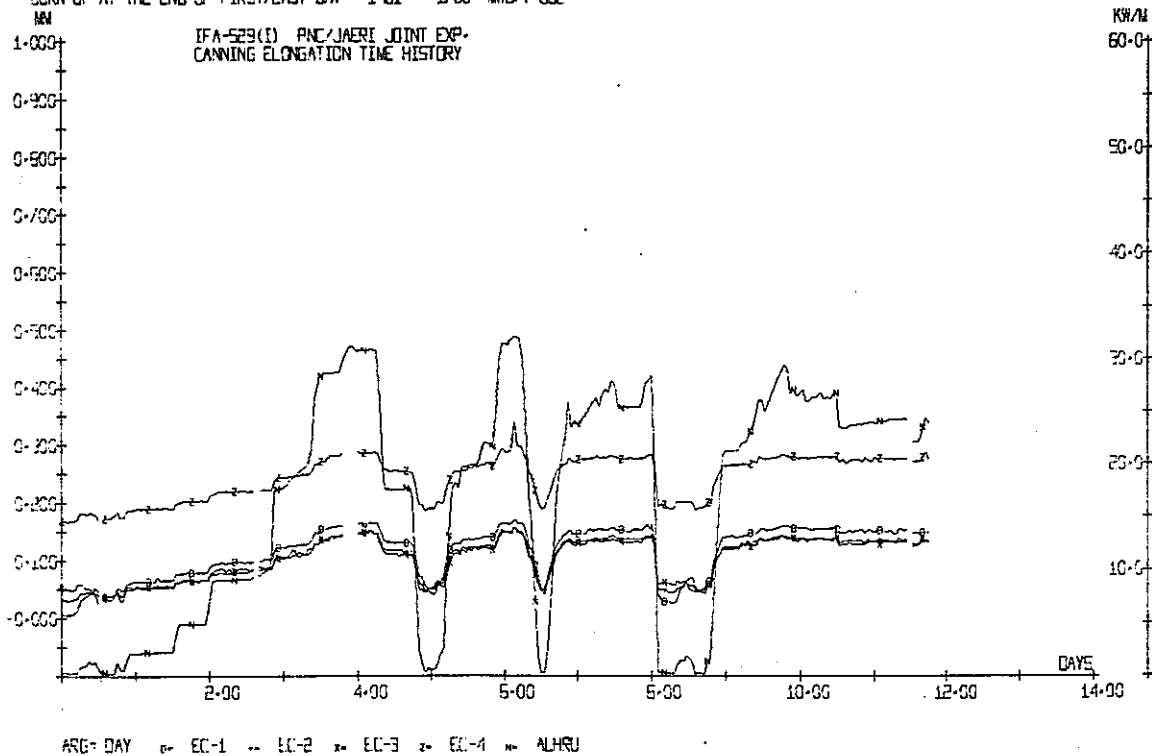

*

OECD HALDEN REACTOR PROJECT

DATA FROM 1 JAN 81 0 HRS TO 14 JAN 81 23:45 HRS
 BURN-UP AT THE END OF FIRST/LAST DAY 1985 99 MWDT UOZ

PLOT 134

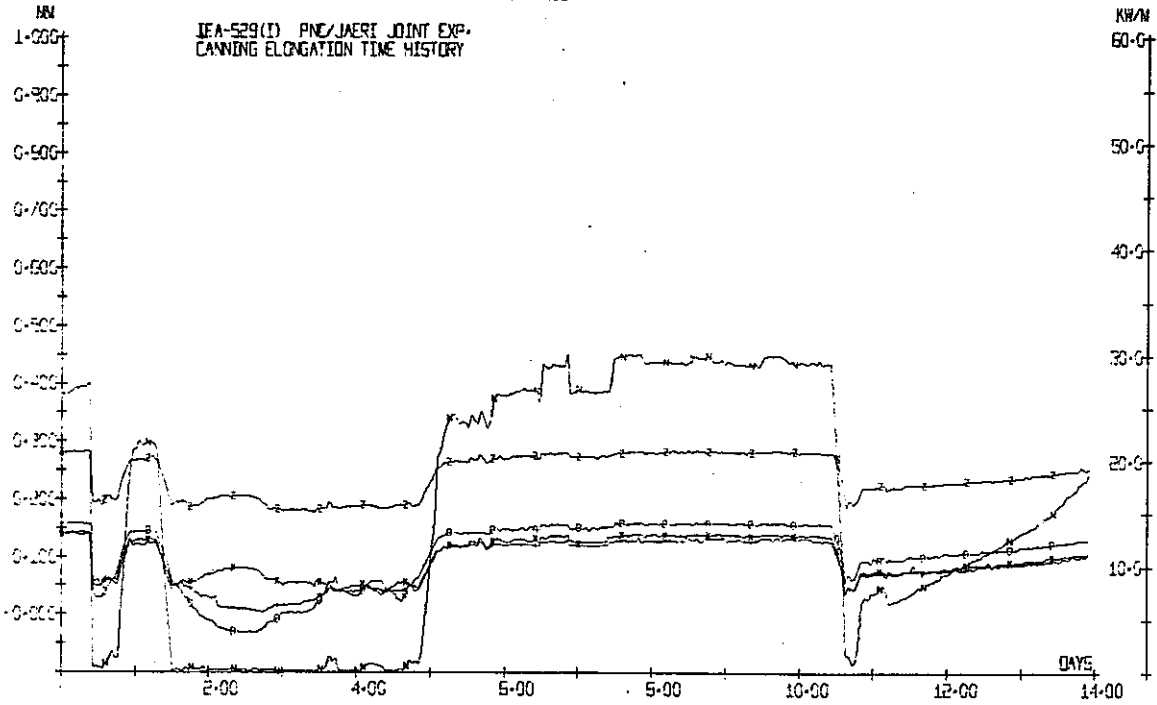

*

OECD HALDEN REACTOR PROJECT

DATA FROM 15 JAN 81 0 HRS TO 19 JAN 81 23:45 HRS
 BURN-UP AT THE END OF FIRST/LAST DAY 99 99 MWDT UOZ

PLOT 134

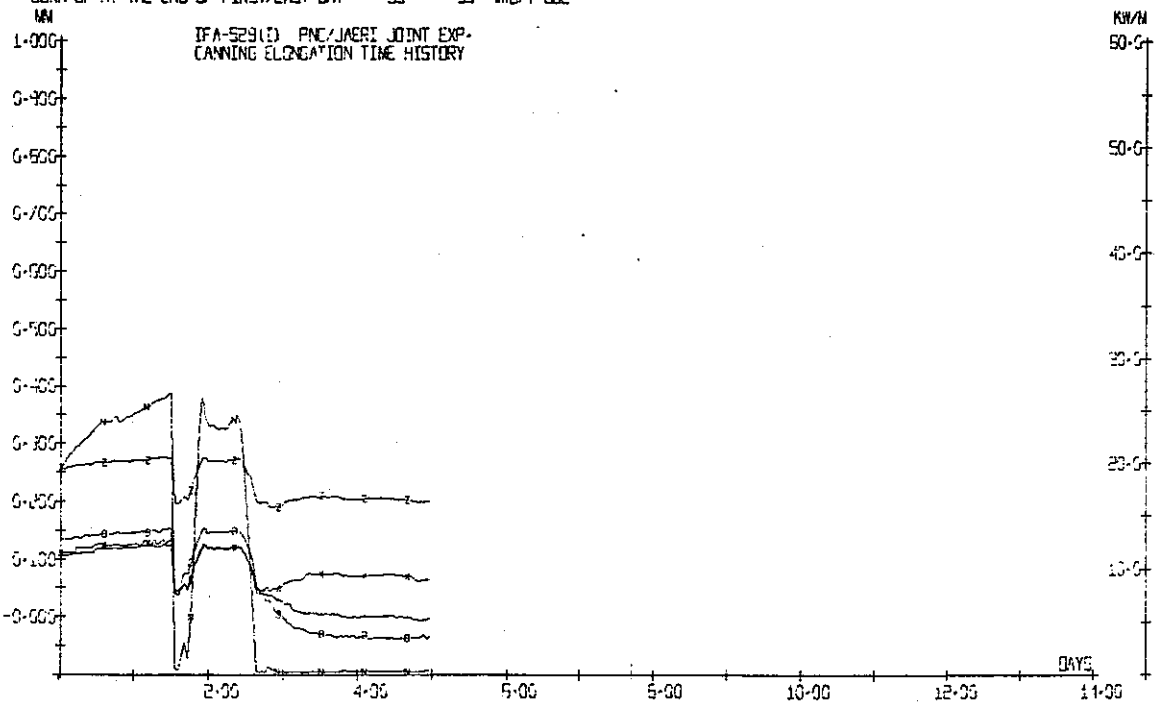

*

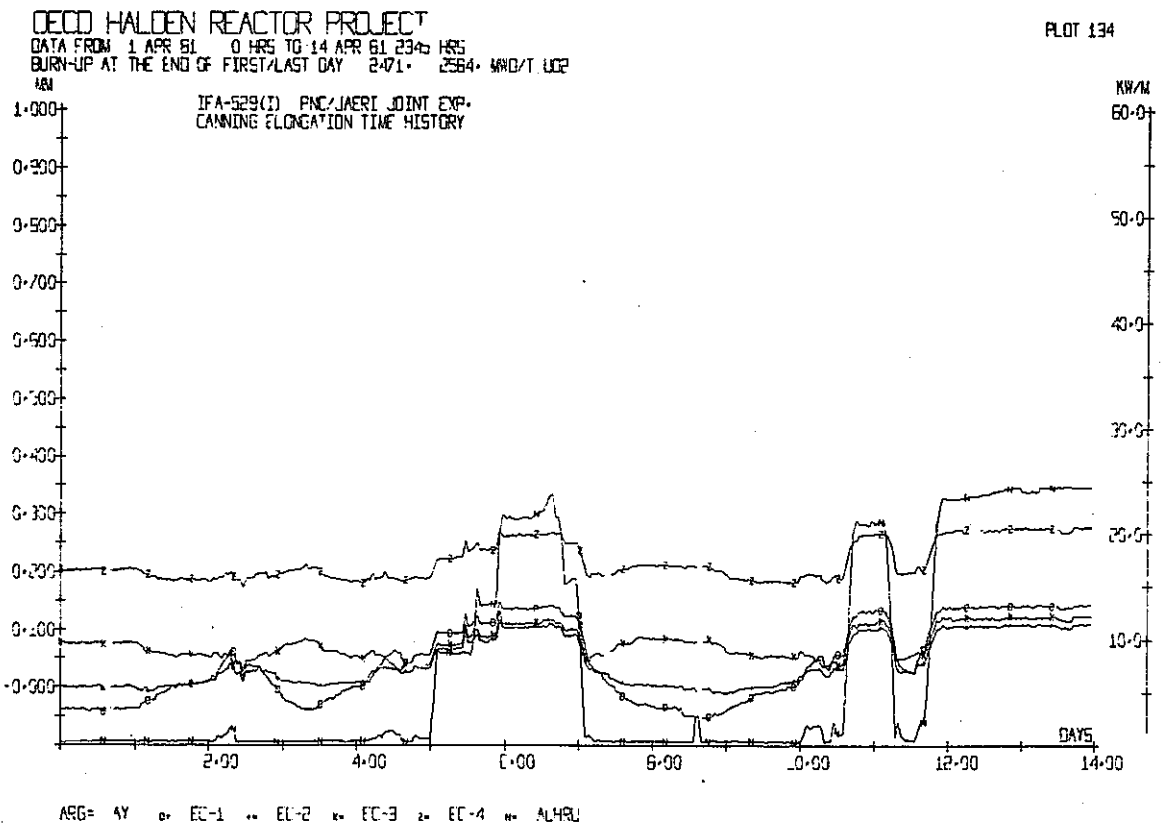
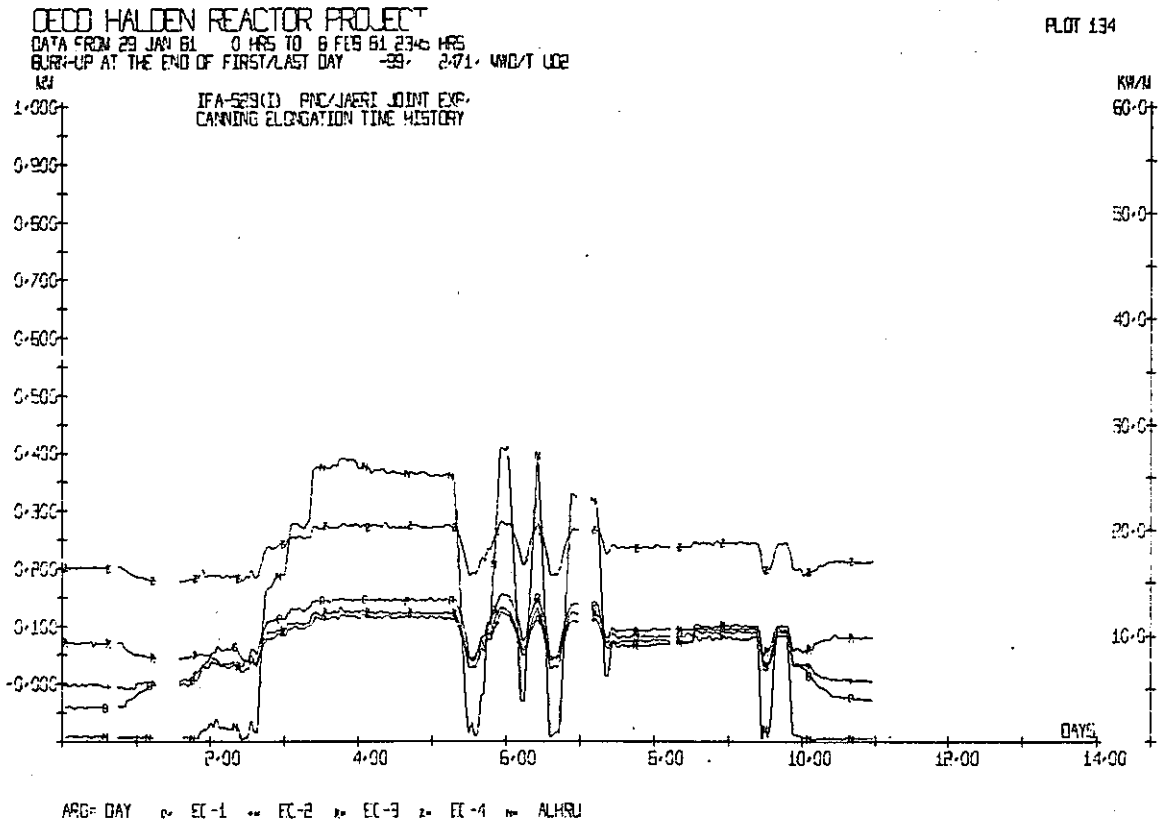

OECD HALDEN REACTOR PROJECT

DATA FROM 15 APR 51 0 HRS TO 25 APR 51 2345 HRS
 BURN-UP AT THE END OF FIRST/LAST DAY 2513 2521 MW/D/T UO2

PLOT 134

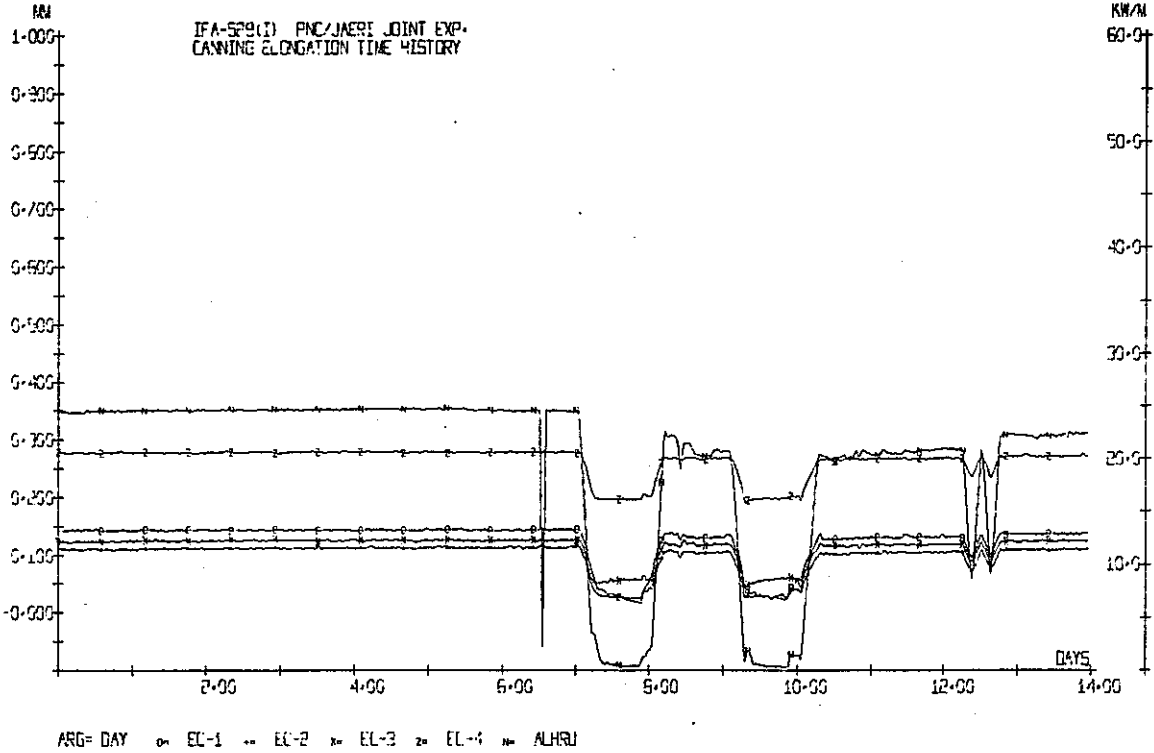

*

OECD HALDEN REACTOR PROJECT

DATA FROM 29 APR 51 0 HRS TO 12 MAY 51 2345 HRS
 BURN-UP AT THE END OF FIRST/LAST DAY 2951 3203 MW/D/T UO2

PLOT 134

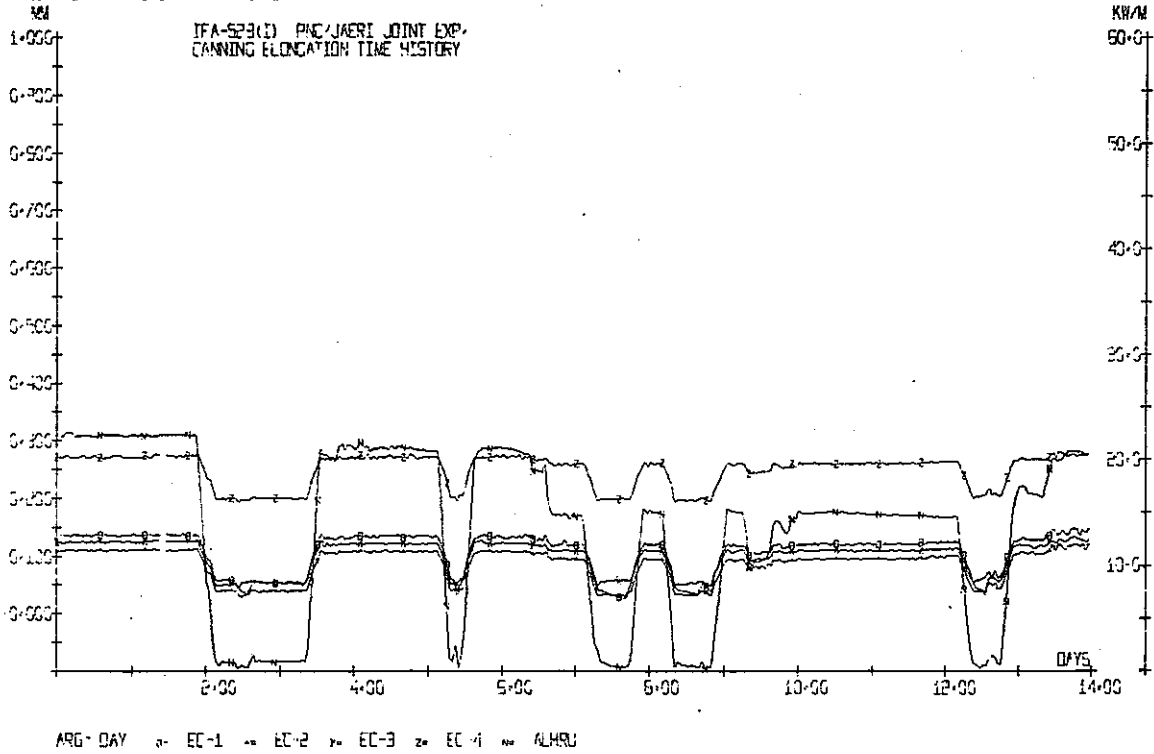

*

OECD HALDEN REACTOR PROJECT
DATA FROM 13 MAY 81 0 HRS TO 25 MAY 81 2345 HRS
BURN-UP AT THE END OF FIRST/LAST DAY 3232 3557 MWDT UO2

PLOT 134

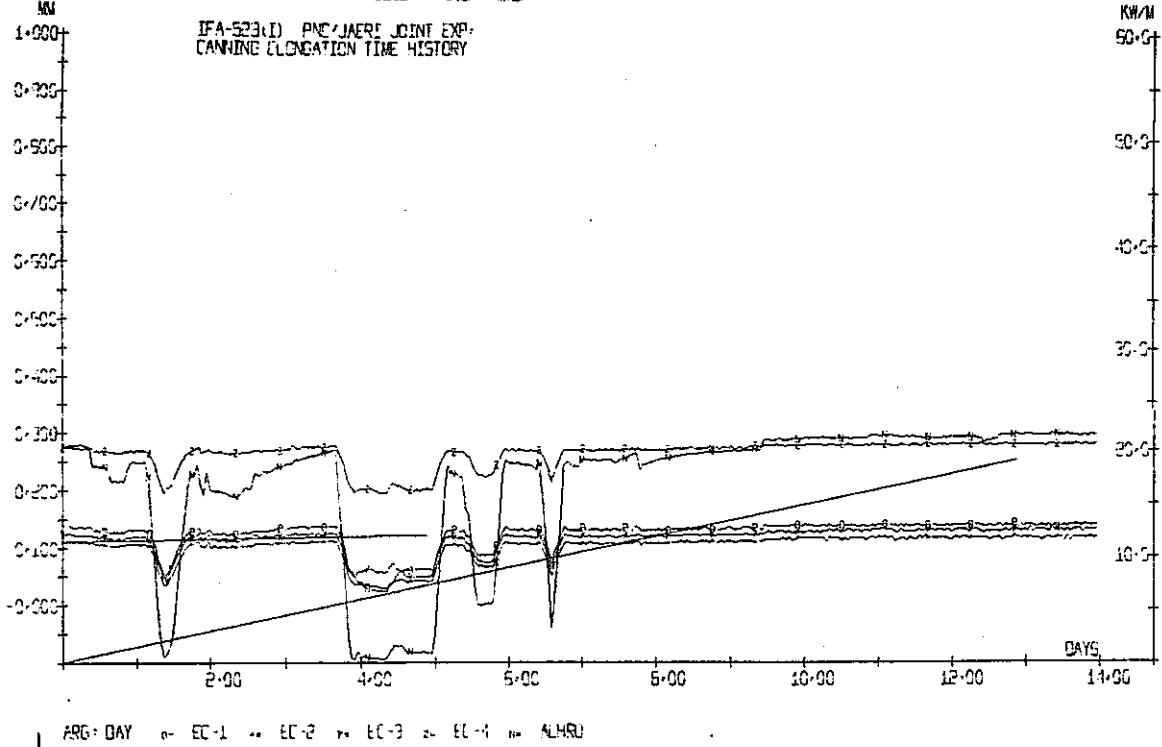

*

OECD HALDEN REACTOR PROJECT
DATA FROM 27 MAY 81 0 HRS TO 6 JUNE 81 2345 HRS
BURN-UP AT THE END OF FIRST/LAST DAY 3567 3662 MWDT UO2

PLOT 134

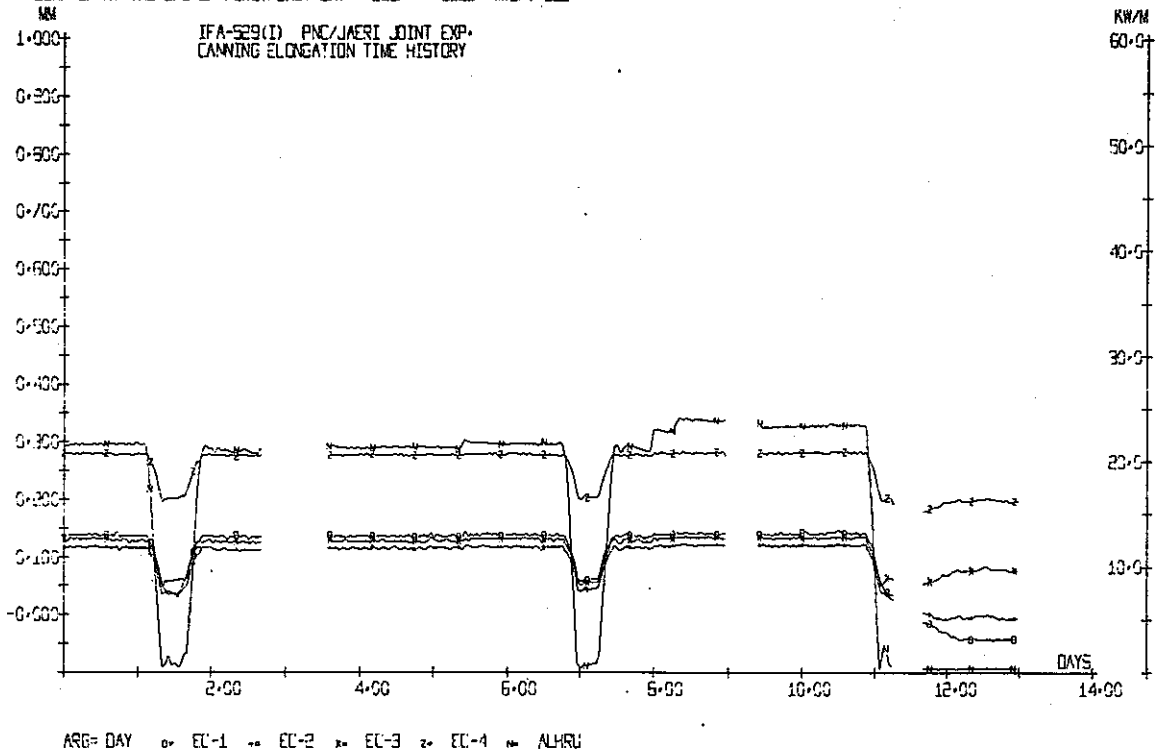

*

OEDD HALDEN REACTOR PROJECT

DATA FROM 20 JUNE 81 0 HRS TO 30 JUNE 81 2345 HRS
 BURN-UP AT THE END OF FIRST/LAST DAY 3662 4051 MW/D/T UOZ

PLOT 134

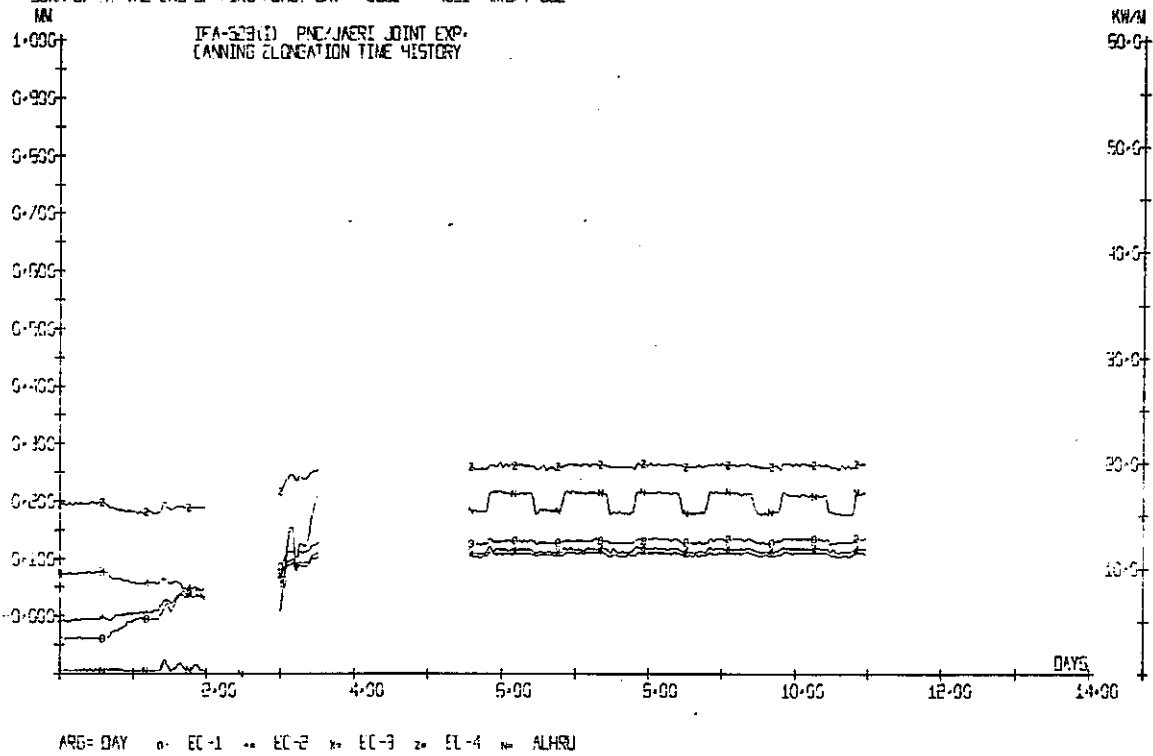

*

OEDD HALDEN REACTOR PROJECT

DATA FROM 1 JULY 81 0 HRS TO 14 JULY 81 2345 HRS
 BURN-UP AT THE END OF FIRST/LAST DAY 4067 4466 MW/D/T UOZ

PLOT 134

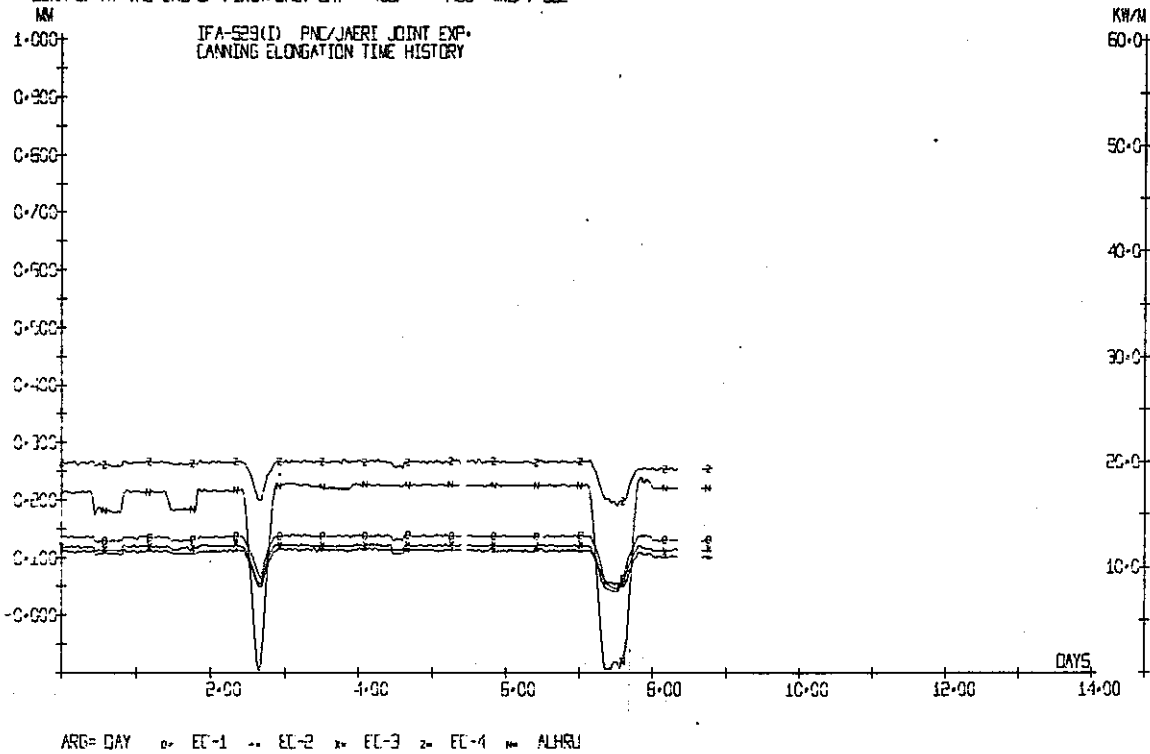

*

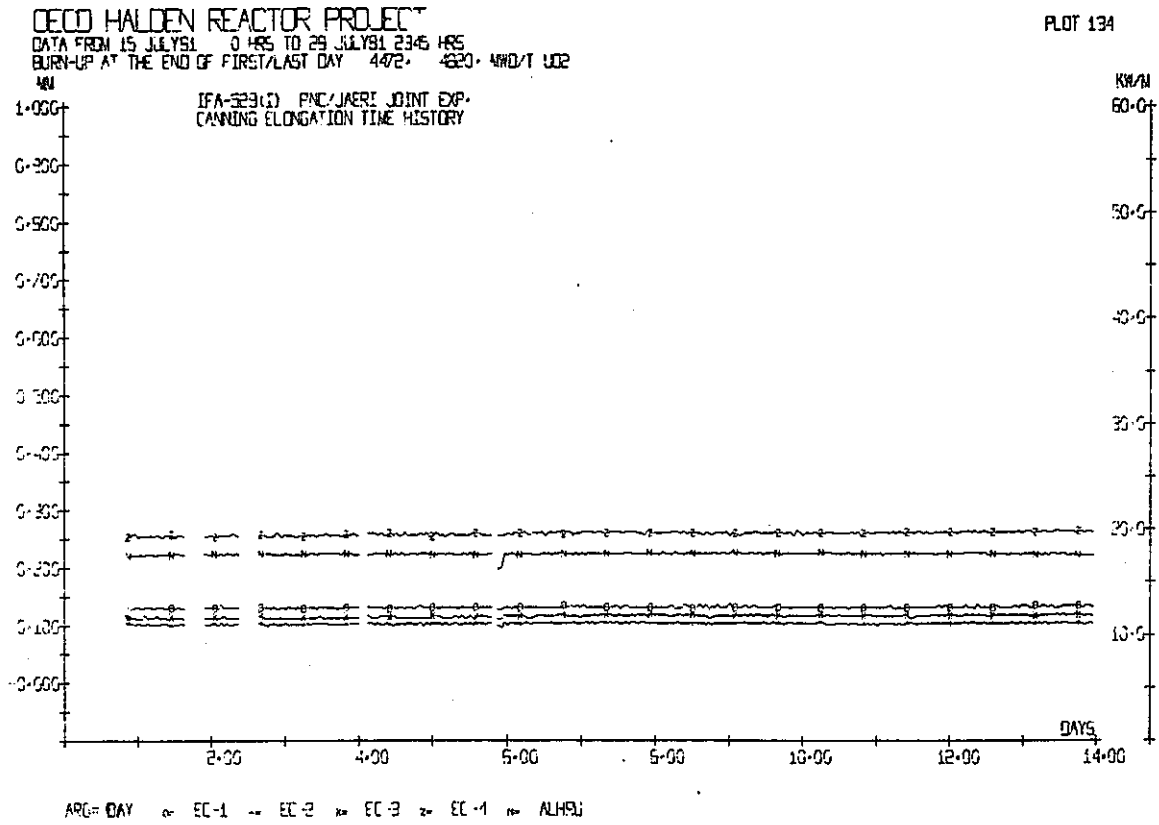

*

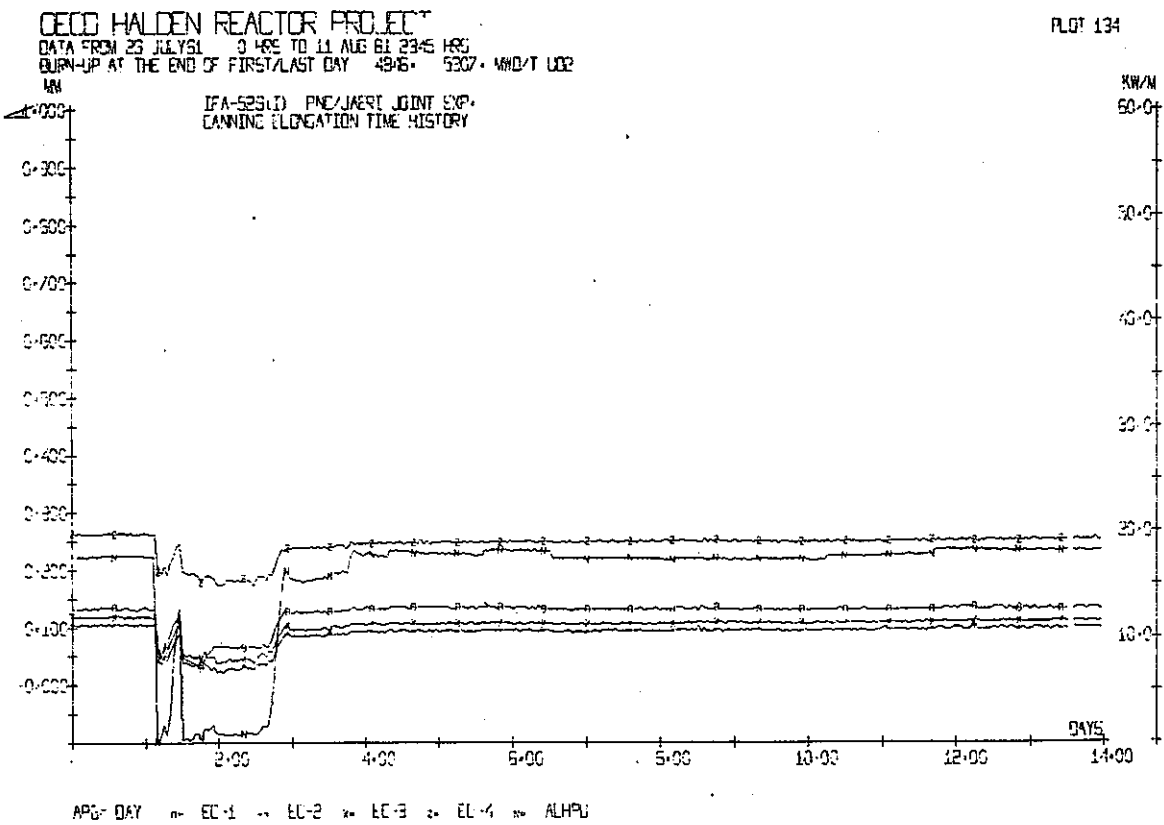

*

OECD HALDEN REACTOR PROJECT

DATA FROM 12 AUG 61 0 HRS TO 22 AUG 61 23:45 HRS
 BURN-UP AT THE END OF FIRST/LAST DAY 5335 5576 MWD/T UO2

PLOT 134

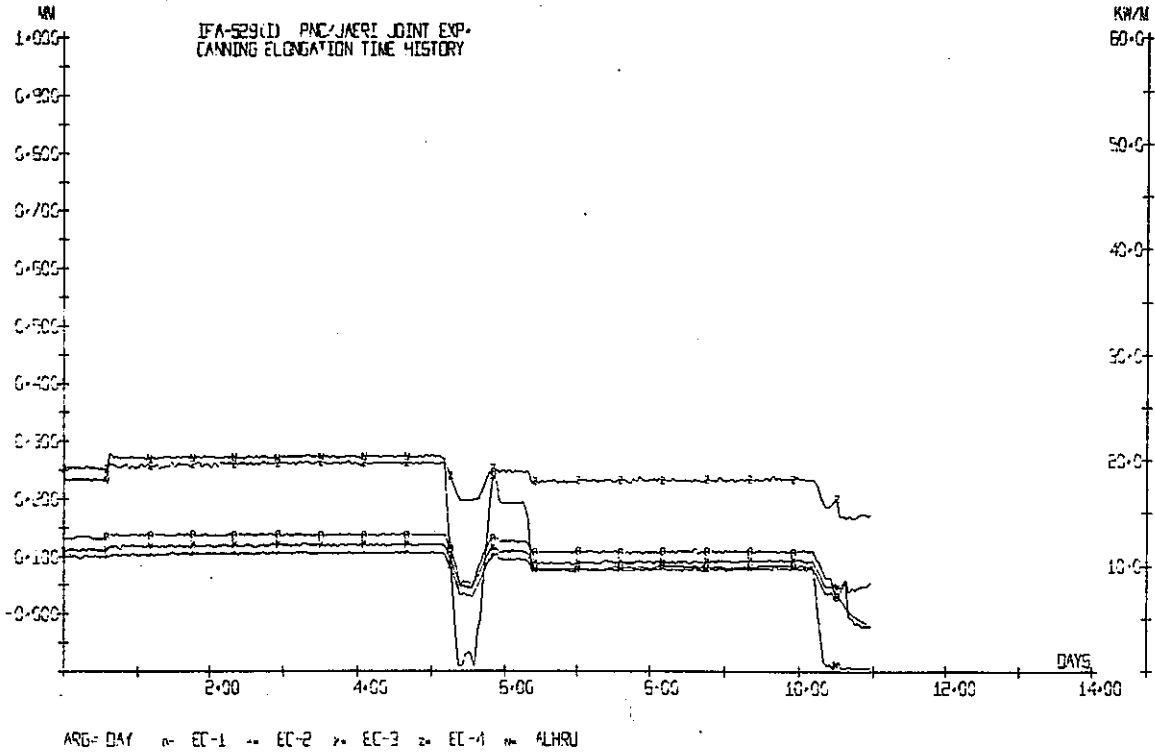

*

OECD HALDEN REACTOR PROJECT

DATA FROM 1 SEPT 61 0 HRS TO 14 SEPT 61 23:45 HRS
 BURN-UP AT THE END OF FIRST/LAST DAY 5577 5676 MWD/T UO2

PLOT 134

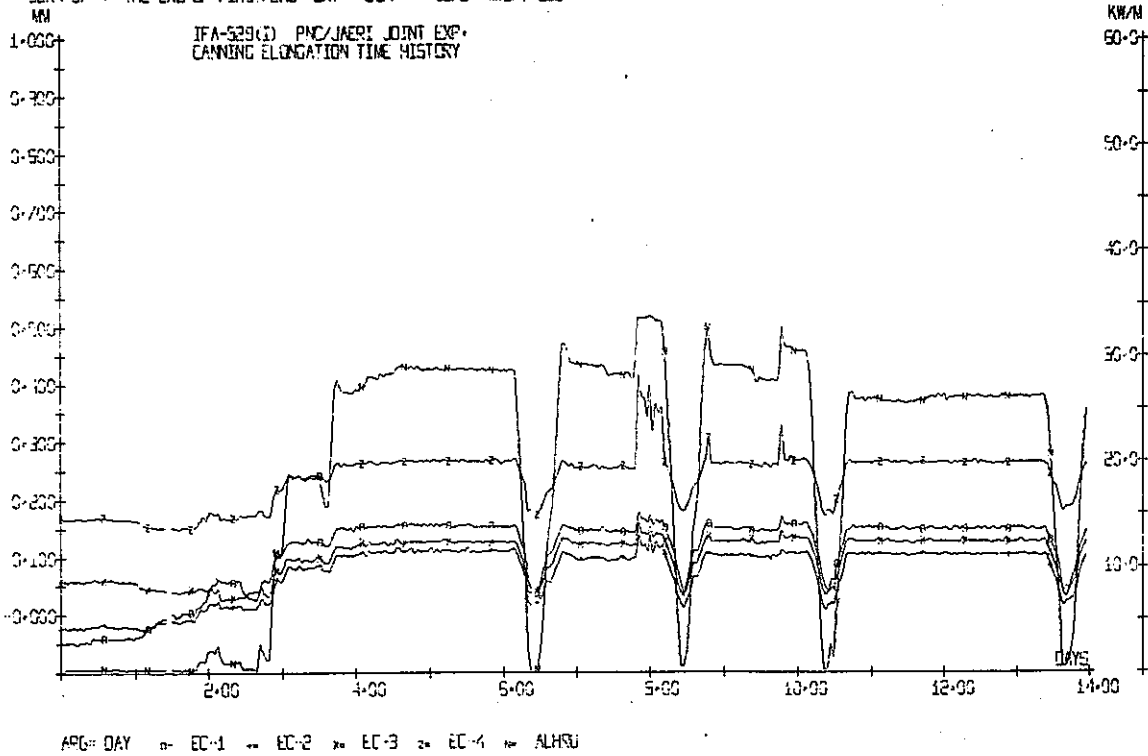

*

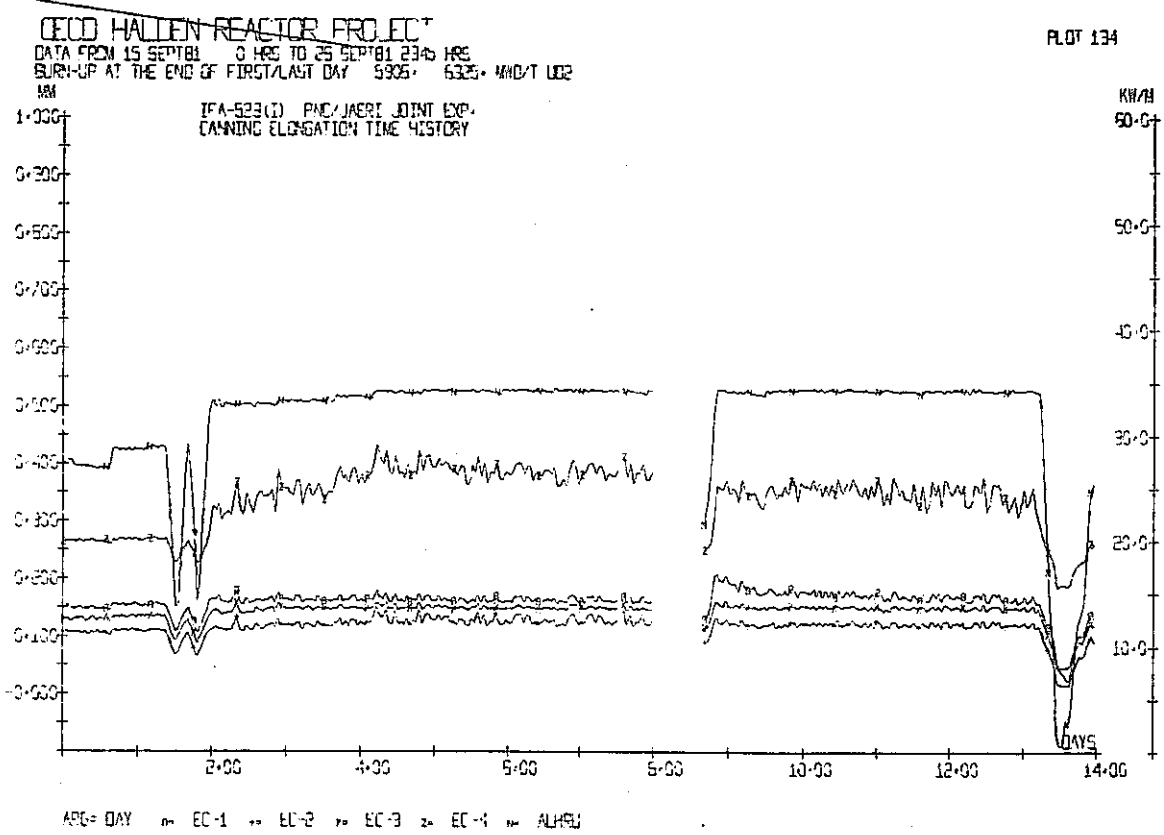

*

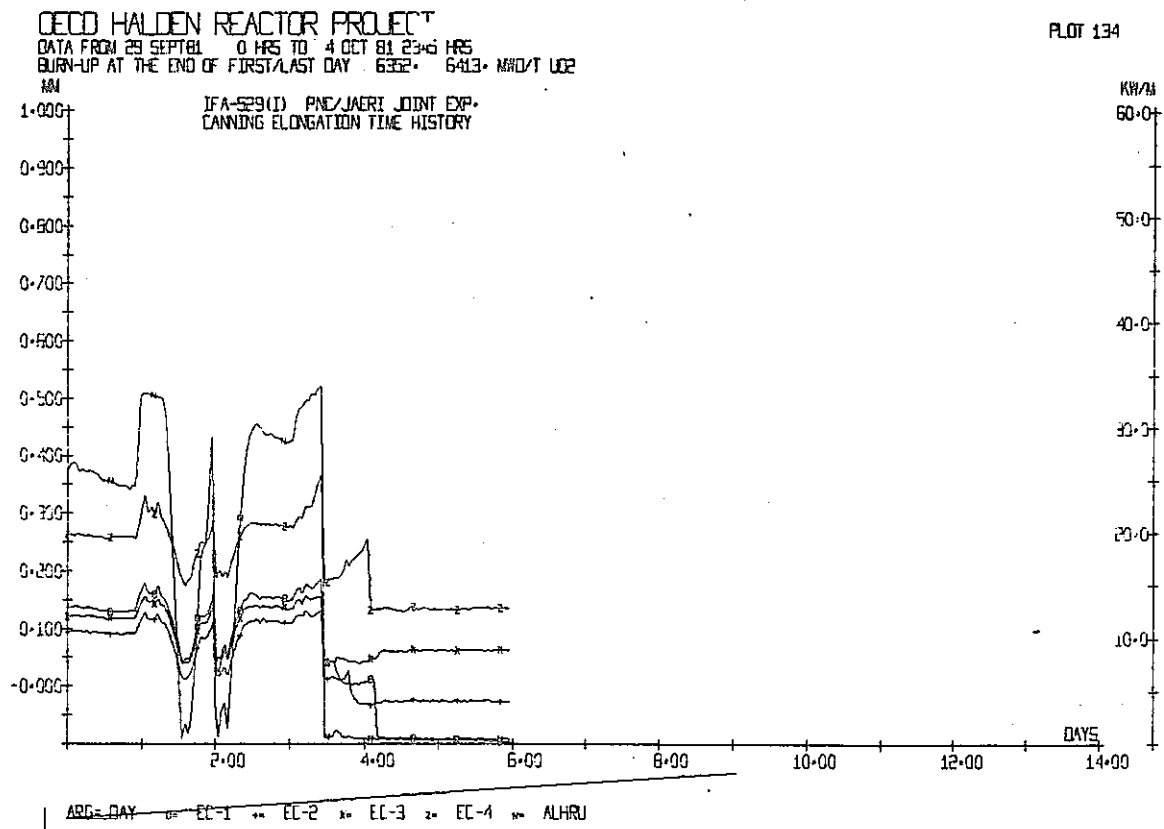

*

OECD HALDEN REACTOR PROJECT
 DATA FROM 21 DEC 81 0 HRS TO 31 DEC 81 23 HRS
 BURN-UP AT THE END OF FIRST/LAST DAY 647 6528 MWDT UO2

PLOT 134

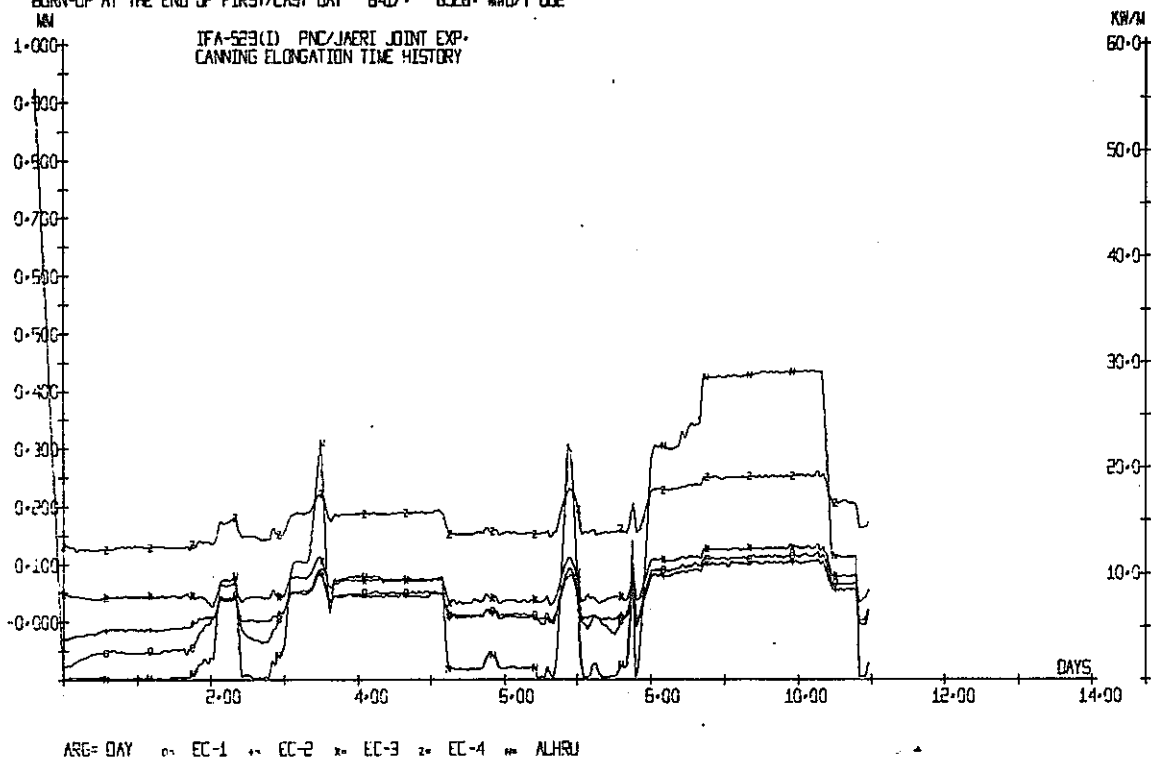

*

OECD HALDEN REACTOR PROJECT
 DATA FROM 1 JAN 82 0 HRS TO 14 JAN 82 23 HRS
 BURN-UP AT THE END OF FIRST/LAST DAY 5531 5651 MWDT UO2

PLOT 134

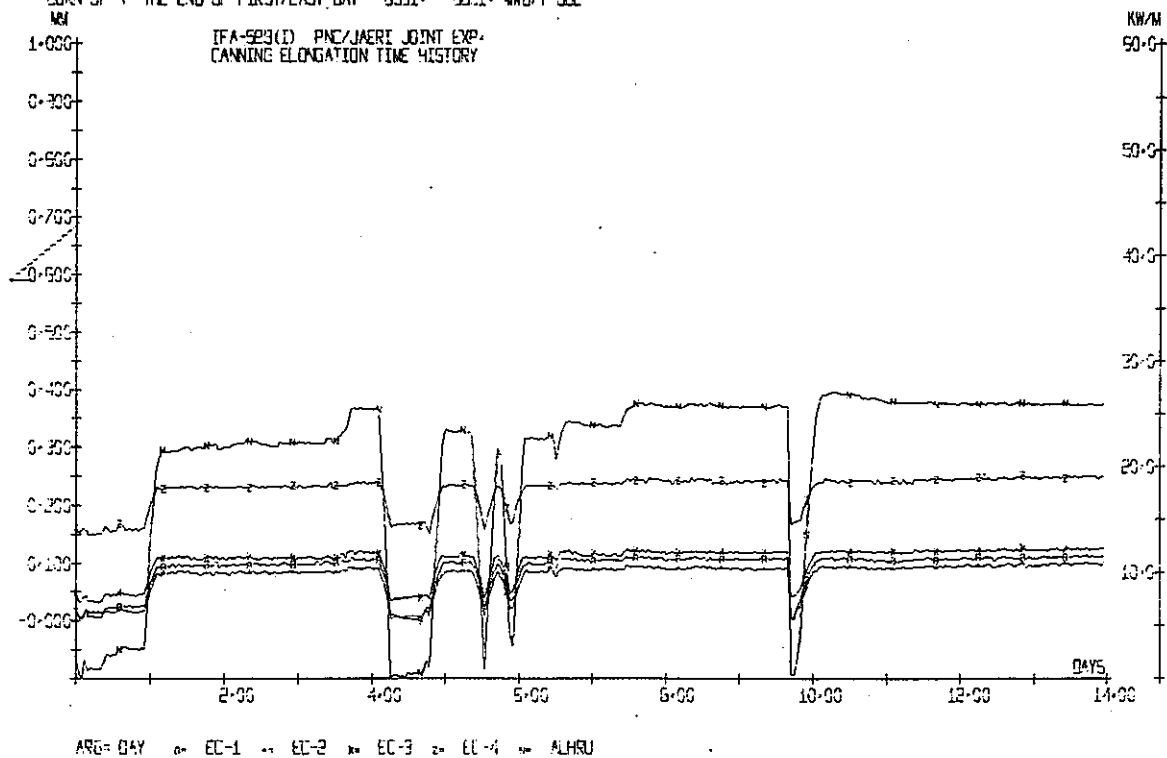

*

OECD HALDEN REACTOR PROJECT
 DATA FROM 13 JAN 62 0 HRS TO 25 JAN 62 23:45 HRS
 BURN-UP AT THE END OF FIRST/LAST DAY 5555 7852 MWDT UOE

PLOT 133

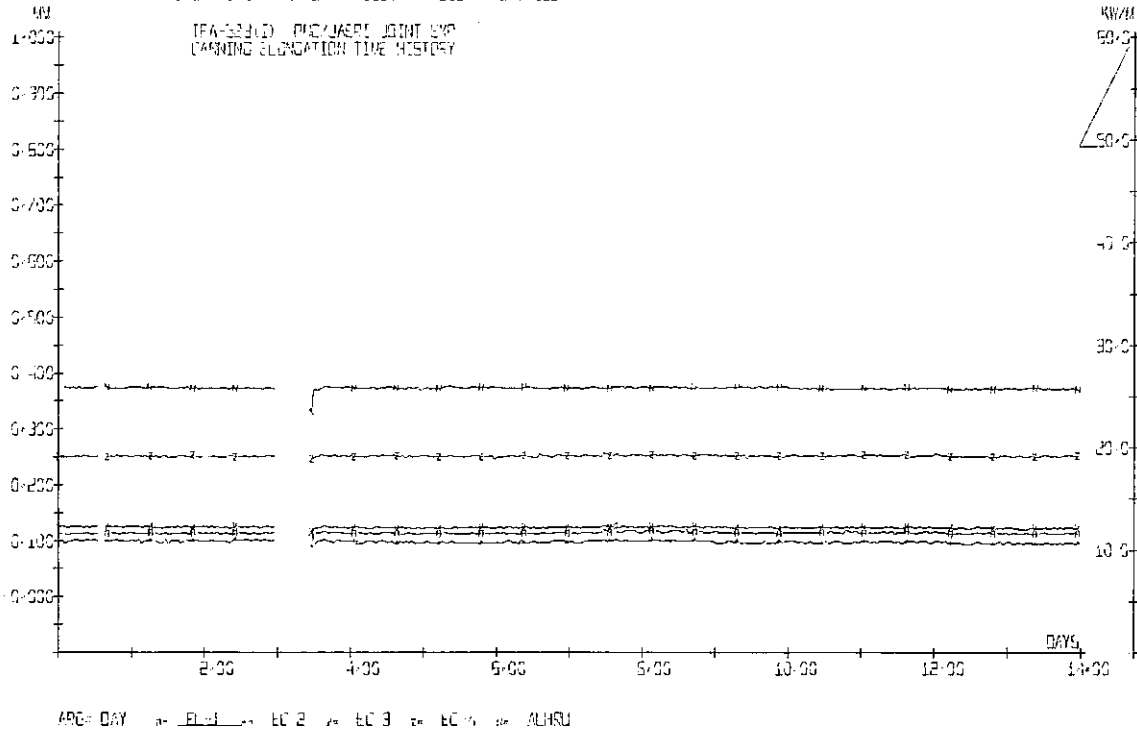

OECD HALDEN REACTOR PROJECT
 DATA FROM 31 JAN 62 0 HRS TO 13 FEB 62 23:45 HRS
 BURN-UP AT THE END OF FIRST/LAST DAY 7337 7517 MWDT UOE

PLOT 134

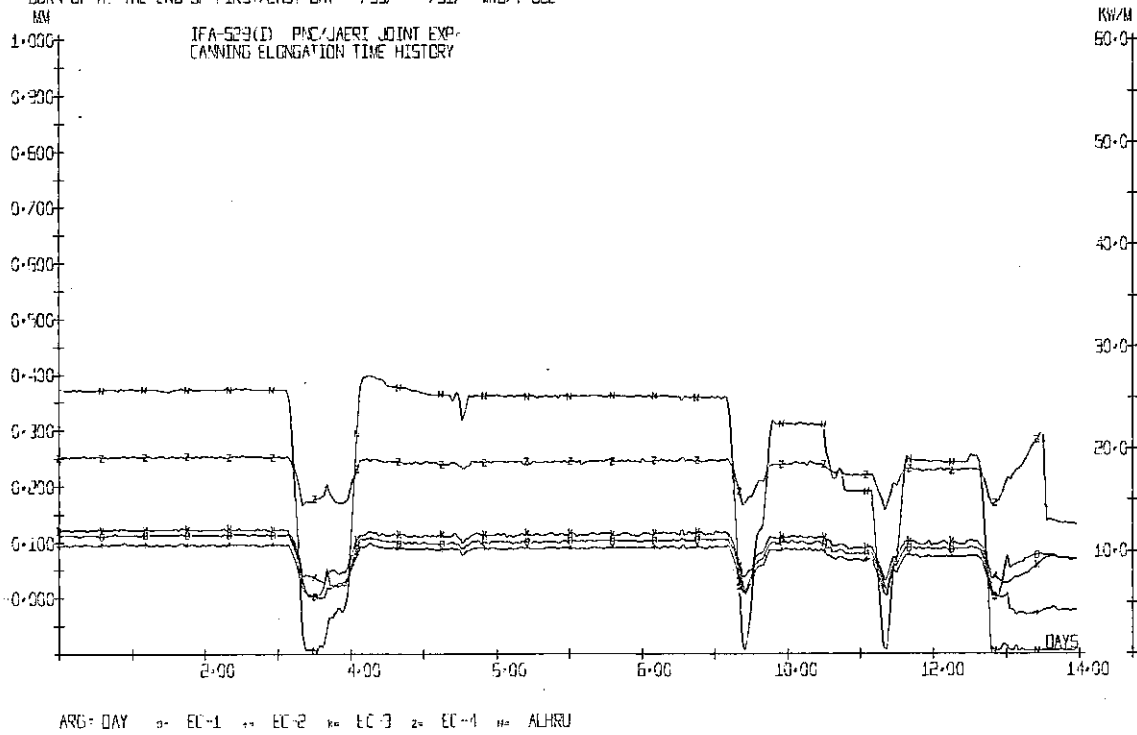

DECO HALDEN REACTOR PROJECT

DATA FROM 25 FEB 82 0 HRS TO 10 MAR 82 23:45 HRS
 BURN-UP AT THE END OF FIRST/LAST DAY 7616 7949 MWDT UO2

PLOT 134

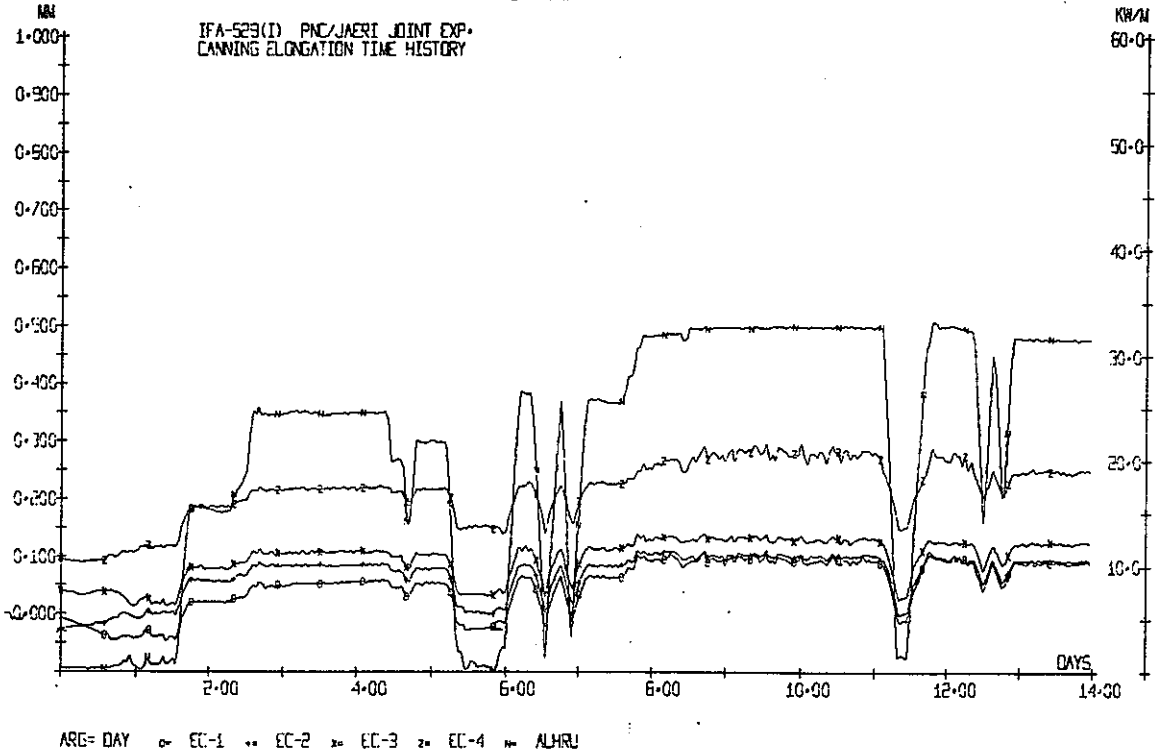

*

DECO HALDEN REACTOR PROJECT

DATA FROM 11 MAR 82 0 HRS TO 24 MAR 82 23:45 HRS
 BURN-UP AT THE END OF FIRST/LAST DAY 7963 8271 MWDT UO2

PLOT 134

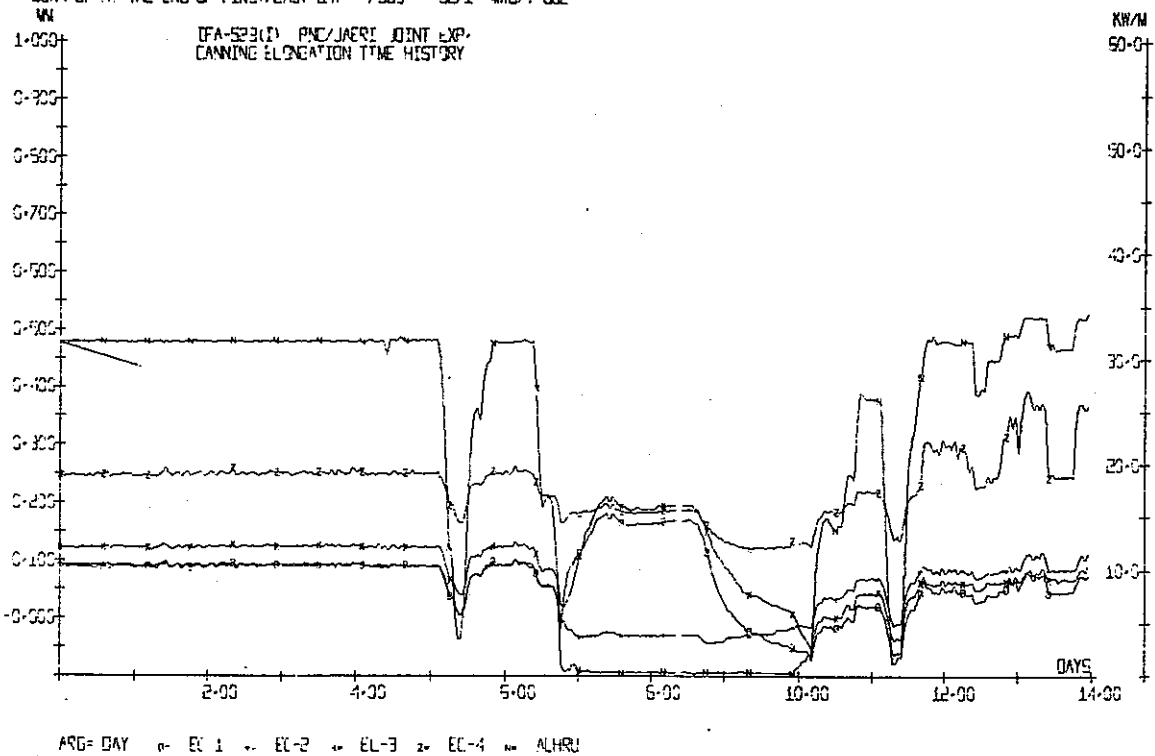

*

OECD HALDEN REACTOR PROJECT
 DATA FROM 25 MAR 82 0 HRS TO 31 MAR 82 23:45 HRS
 BURN-UP AT THE END OF FIRST/LAST DAY 8306 6511 MWDT UOZ

PLOT 134

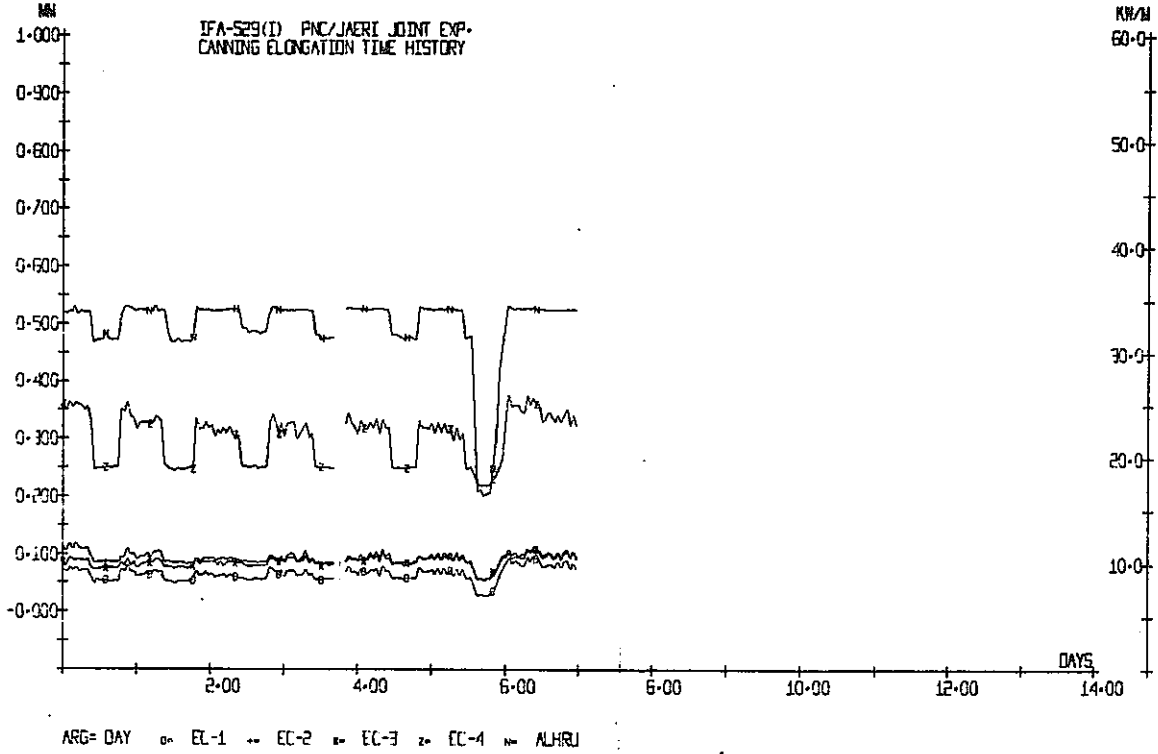

*

OECD HALDEN REACTOR PROJECT
 DATA FROM 1 APR 82 0 HRS TO 13 APR 82 23:45 HRS
 BURN-UP AT THE END OF FIRST/LAST DAY 8526 8748 MWDT UOZ

PLOT 134

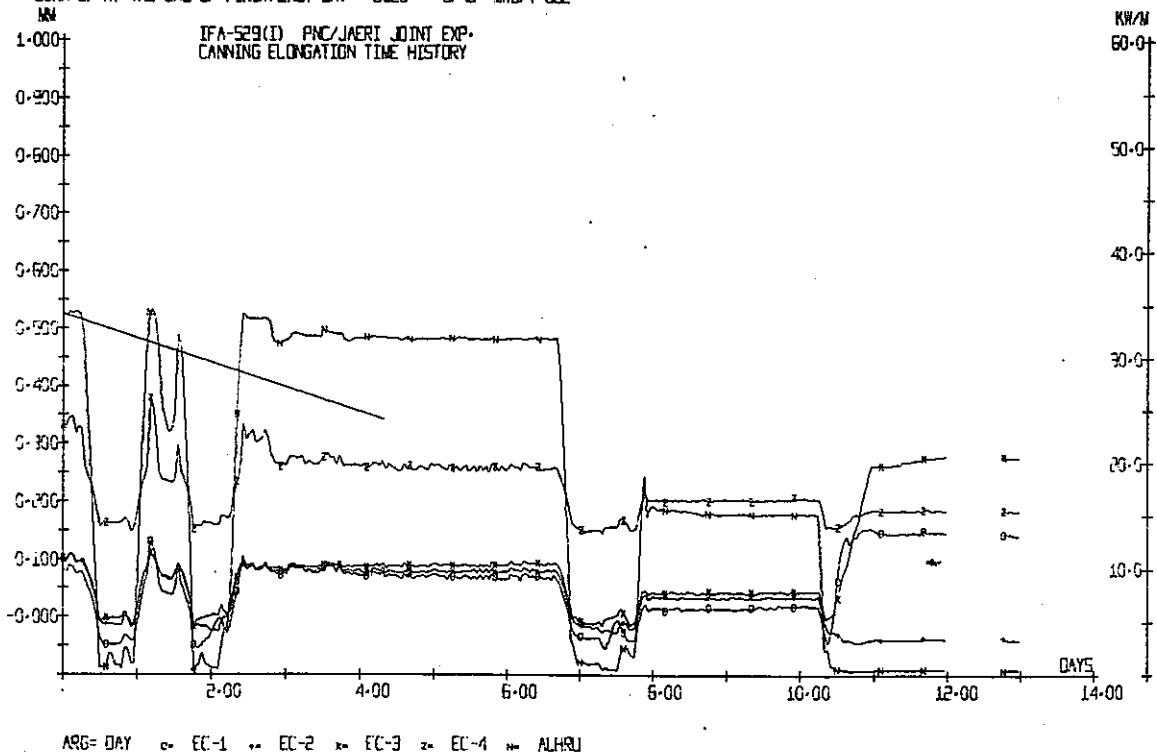

*

OECD HALDEN REACTOR PROJECT
 DATA FROM 15 JUNE 82 0 HRS TO 27 JUNE 82 2345 HRS
 BURN-UP AT THE END OF FIRST/LAST DAY 8512 9798 MWDT UO2

PLOT 134

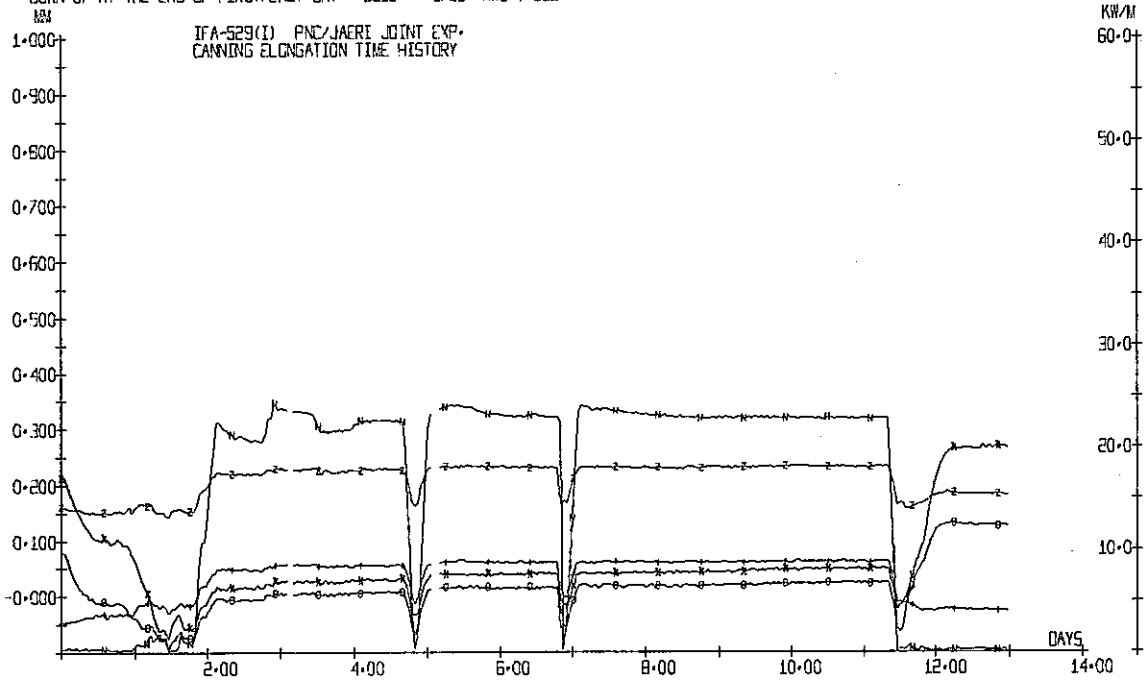

ARG= DAY 0= EC-1 ** EC-2 * EC-3 z= EC-4 # ALHRU

*

OECD HALDEN REACTOR PROJECT
 DATA FROM 19 MAY 82 0 HRS TO 1 JUNE 82 2345 HRS
 BURN-UP AT THE END OF FIRST/LAST DAY 9213 5433 MWDT UO2

PLOT 134

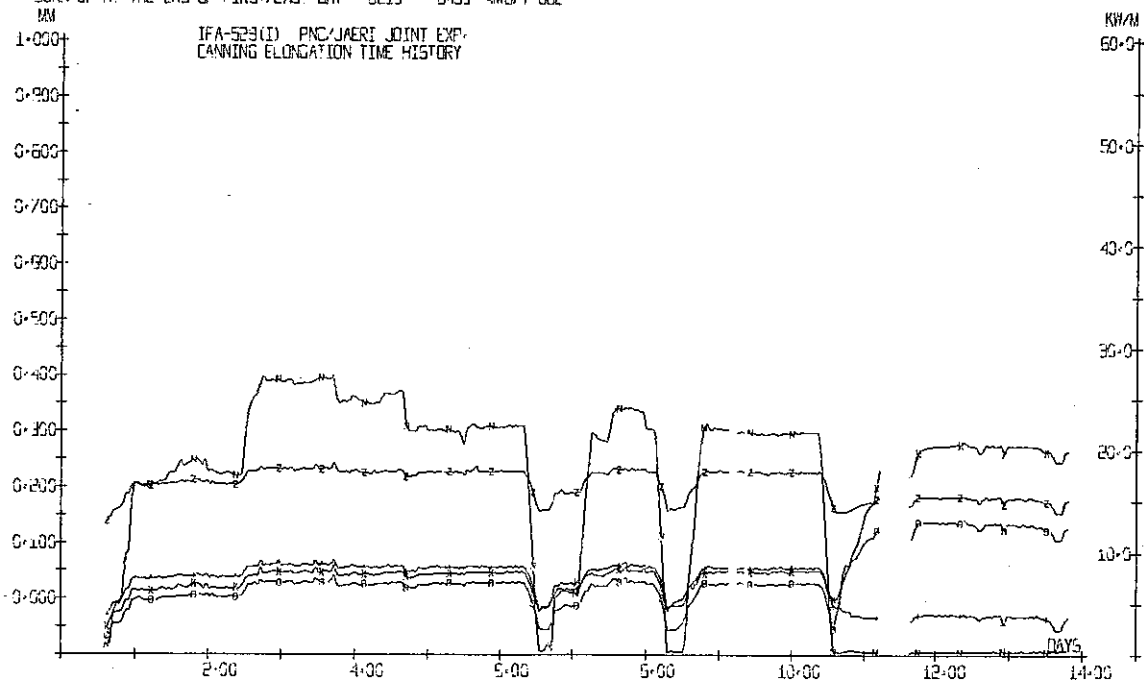

ARG= DAY 0= EC-1 ** EC-2 * EC-3 z= EC-4 # ALHRU

*

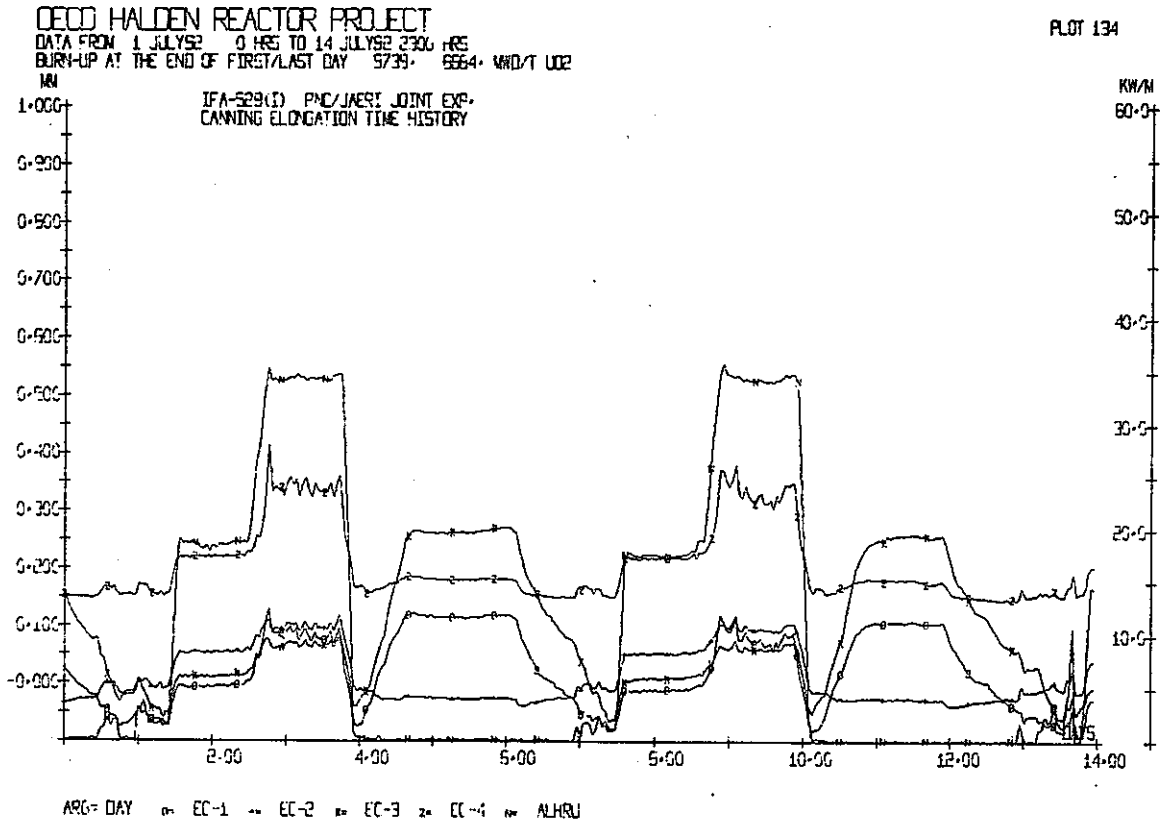

*

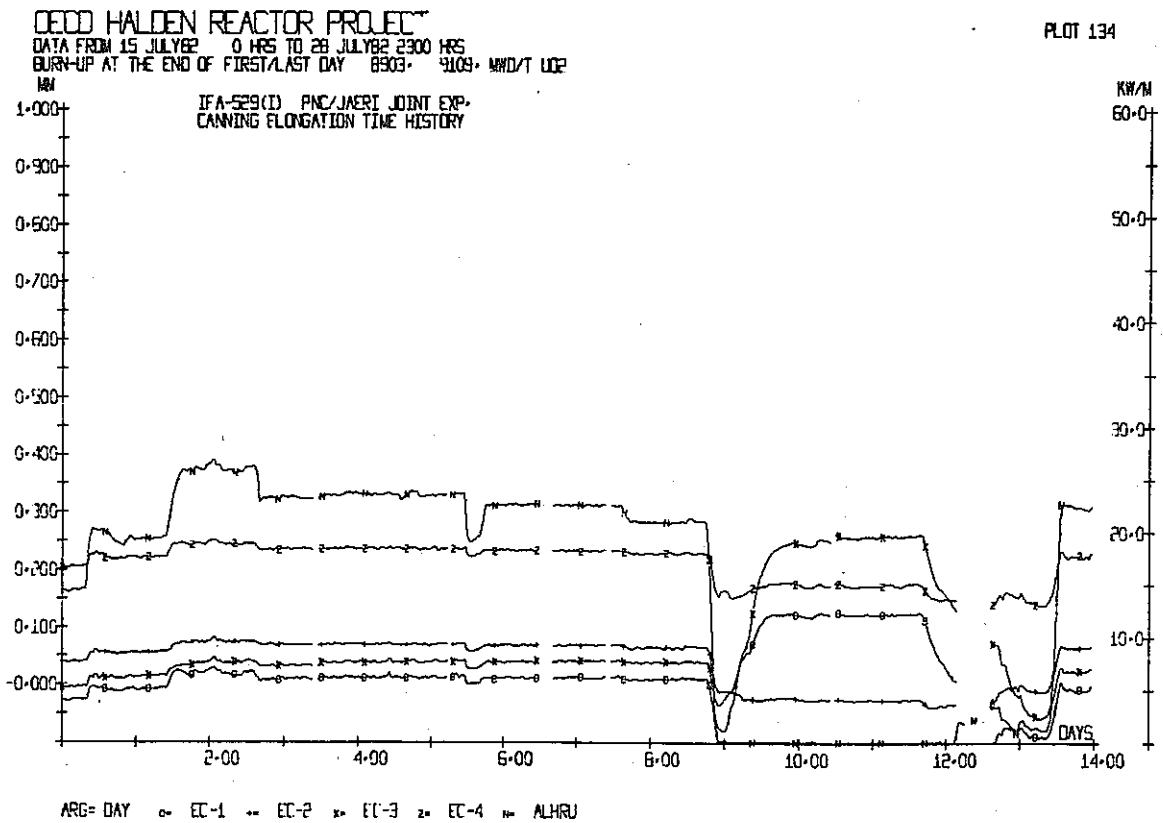

*

OECD HALDEN REACTOR PROJECT

DATA FROM 29 JULY 82 0 HRS TO 7 AUG 82 2300 HRS
 BURN-UP AT THE END OF FIRST/LAST DAY 9135 9162 MW/D/1 UO2

PLOT 134

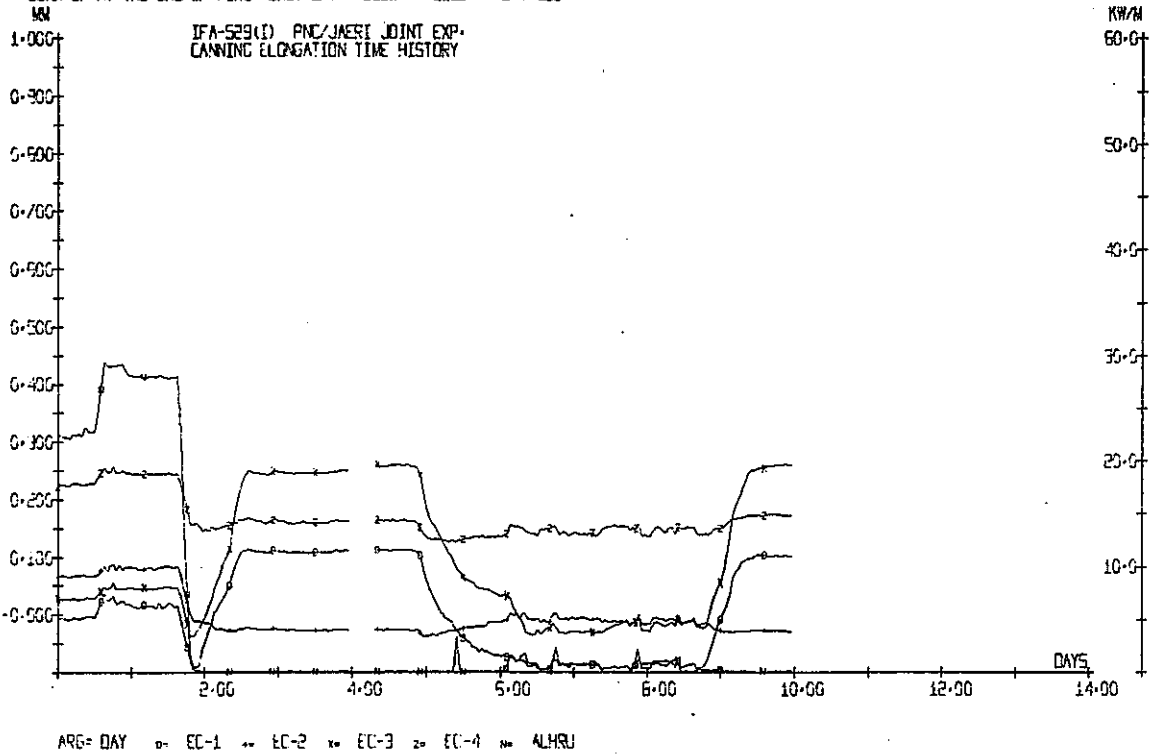

*

OECD HALDEN REACTOR PROJECT

DATA FROM 12 AUG 82 0 HRS TO 24 AUG 82 2300 HRS
 BURN-UP AT THE END OF FIRST/LAST DAY 9163 9305 MW/D/1 UO2

PLOT 134

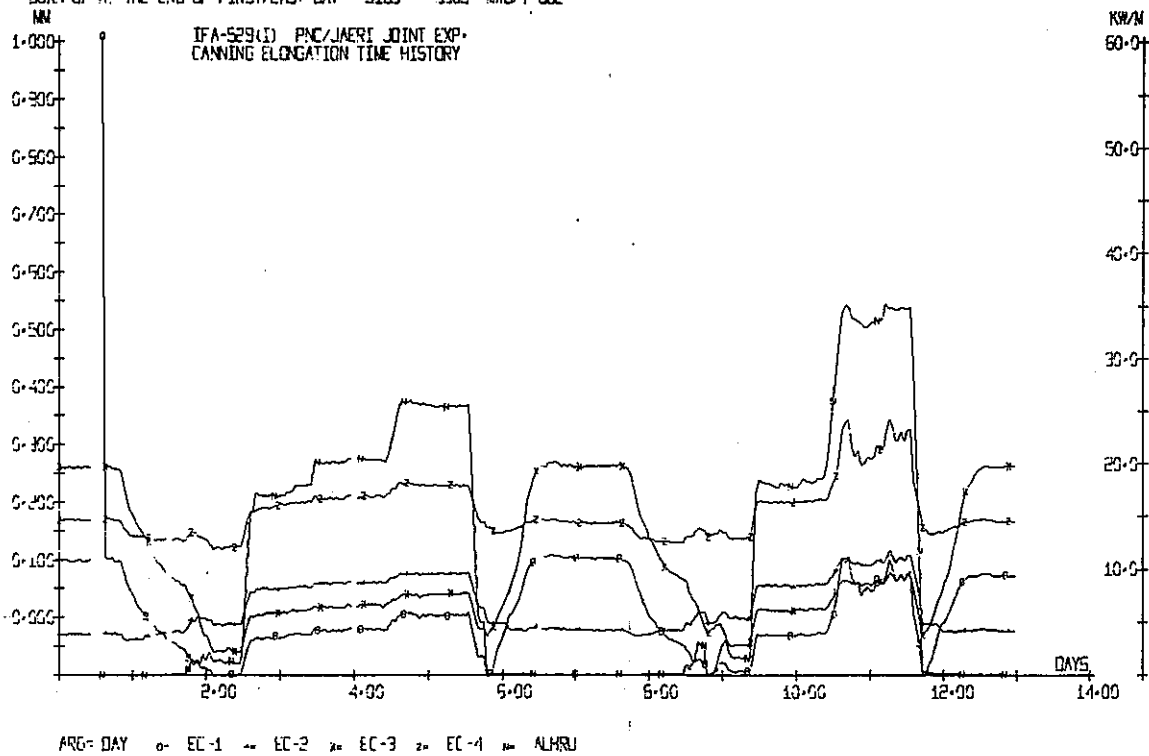

*

OECD HALDEN REACTOR PROJECT
 DATA FROM 19 SEPT 82 0 HRS TO 30 SEPT 82 2300 HRS
 BURN-UP AT THE END OF FIRST/LAST DAY 9306 9486 MW/D/T UO2

PLOT 134

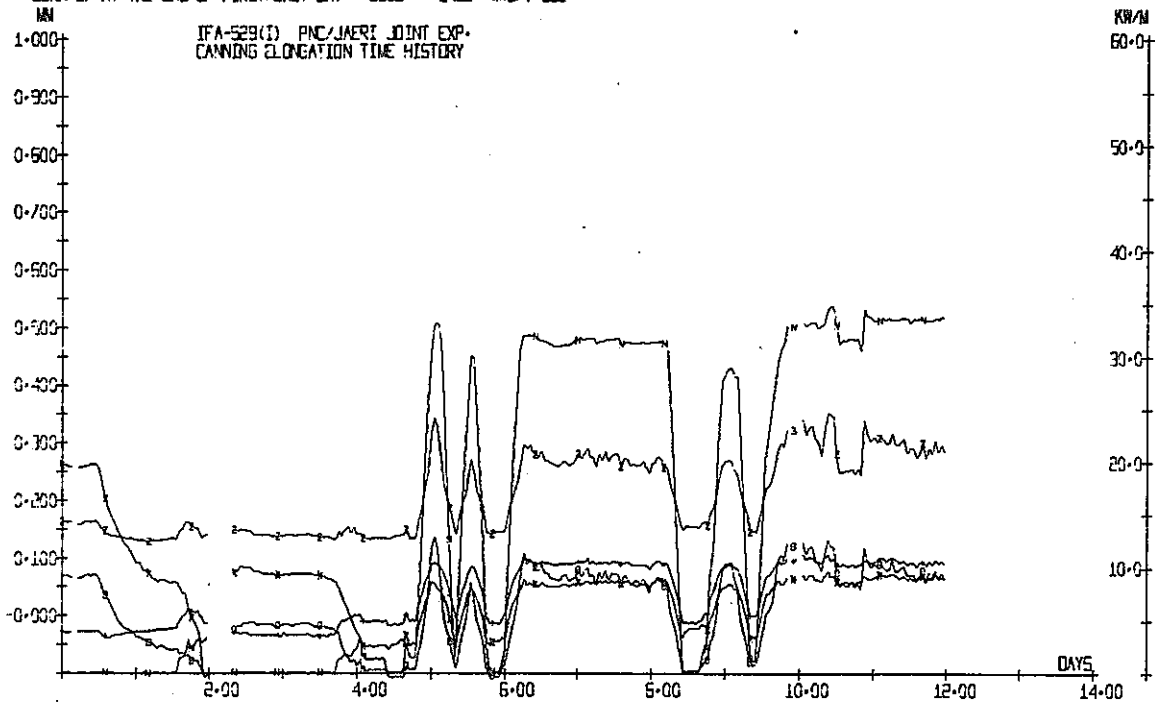

ARG= DAY 0= EC-1 1= EC-2 2= EC-3 3= EC-4 4= ALHRU

*

OECD HALDEN REACTOR PROJECT
 DATA FROM 1 OCT 82 0 HRS TO 14 OCT 82 2300 HRS
 BURN-UP AT THE END OF FIRST/LAST DAY 9536 9642 MW/D/T UO2

PLOT 134

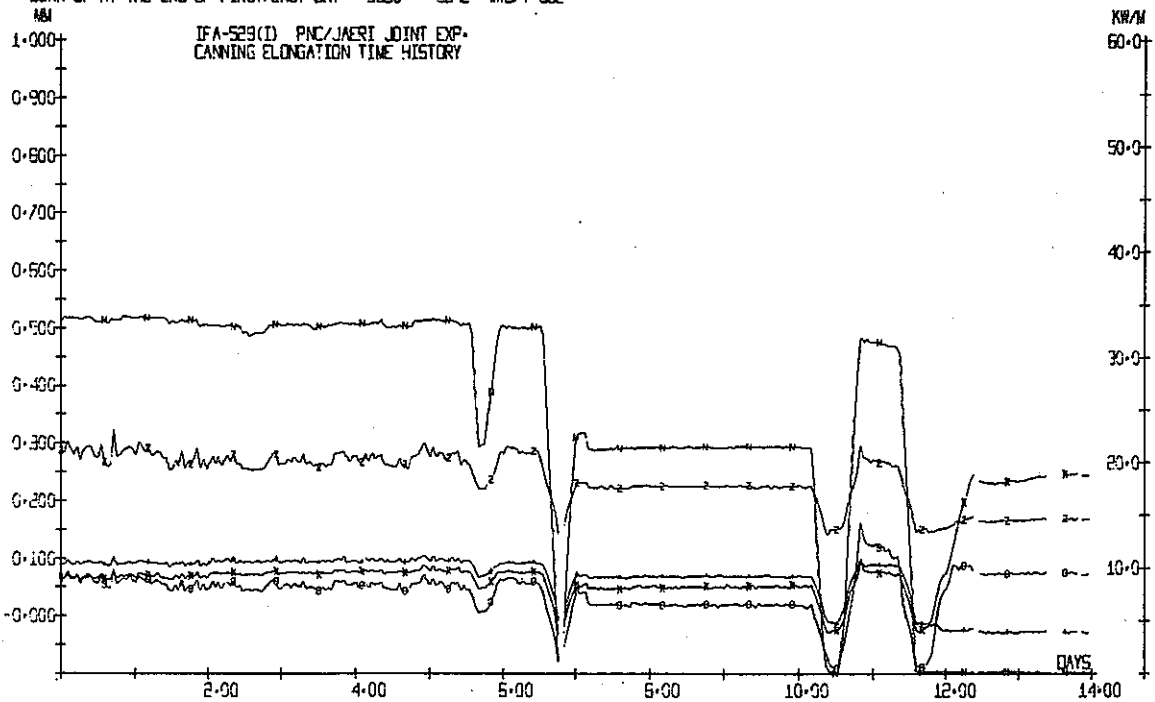

ARG= DAY 0= EC-1 1= EC-2 2= EC-3 3= EC-4 4= ALHRU

*

OECD HALDEN REACTOR PROJECT

DATA FROM 5 NOV 82 0 HRS TO 20 NOV 82 2300 HRS
 BURN-UP AT THE END OF FIRST/LAST DAY 10013 10225 MWD/T UO2

PLOT 134

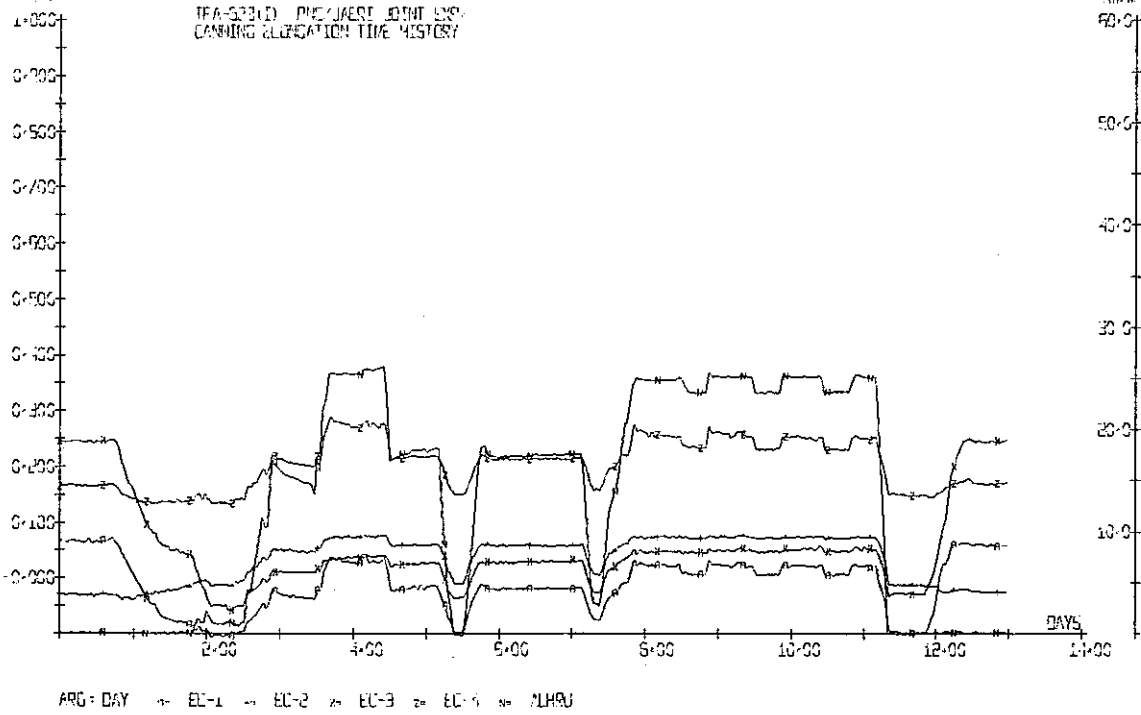

*

OECD HALDEN REACTOR PROJECT

DATA FROM 15 OCT 82 0 HRS TO 26 OCT 82 2300 HRS
 BURN-UP AT THE END OF FIRST/LAST DAY 9842 10319 MWD/T UO2

PLOT 134

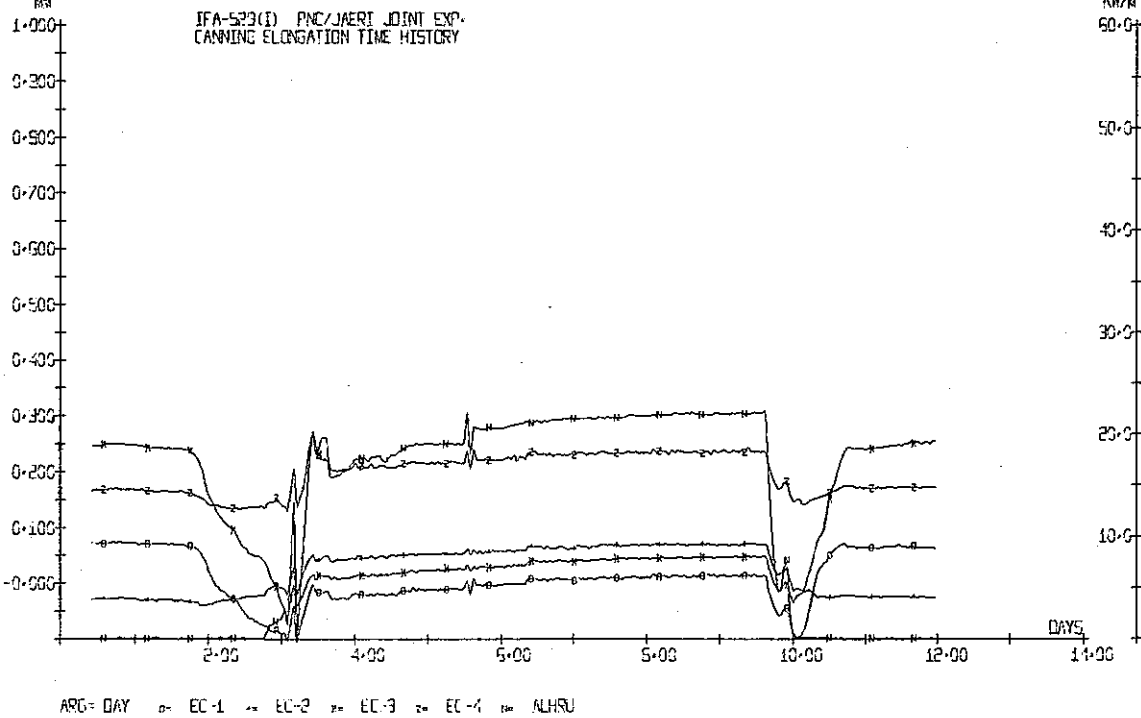

*

OECD HALDEN REACTOR PROJECT

DATA FROM 24 NOV 82 0 HRS TO 7 DEC 82 2300 HRS
 BURN-UP AT THE END OF FIRST/LAST DAY 10216 - 10515 MWDT UO2

PLOT 134

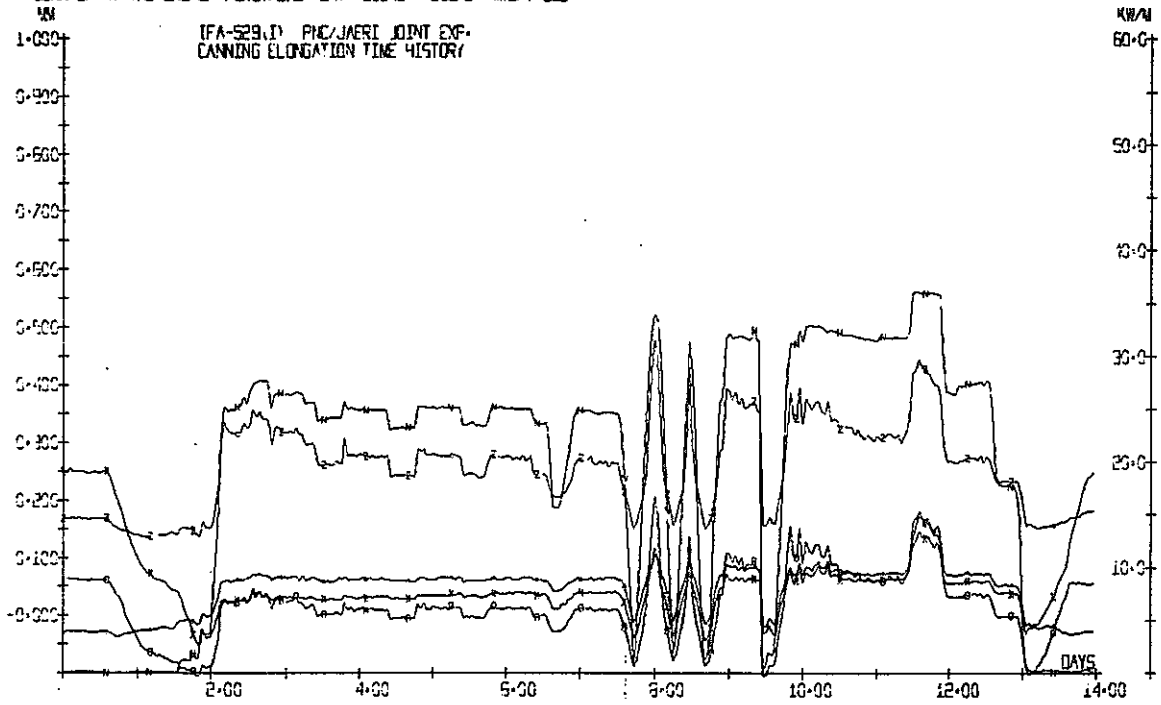

IFA-529(D) PNC/JAERI JOINT EXP.
 CANNING ELONGATION TIME HISTORY

ARG= DAY 0 EC-1 EC-2 EC-3 EC-4 ALHRU

*

OECD HALDEN REACTOR PROJECT

DATA FROM 16 DEC 82 0 HRS TO 31 DEC 82 2300 HRS
 BURN-UP AT THE END OF FIRST/LAST DAY 10581 - 10917 MWDT UO2

PLOT 134

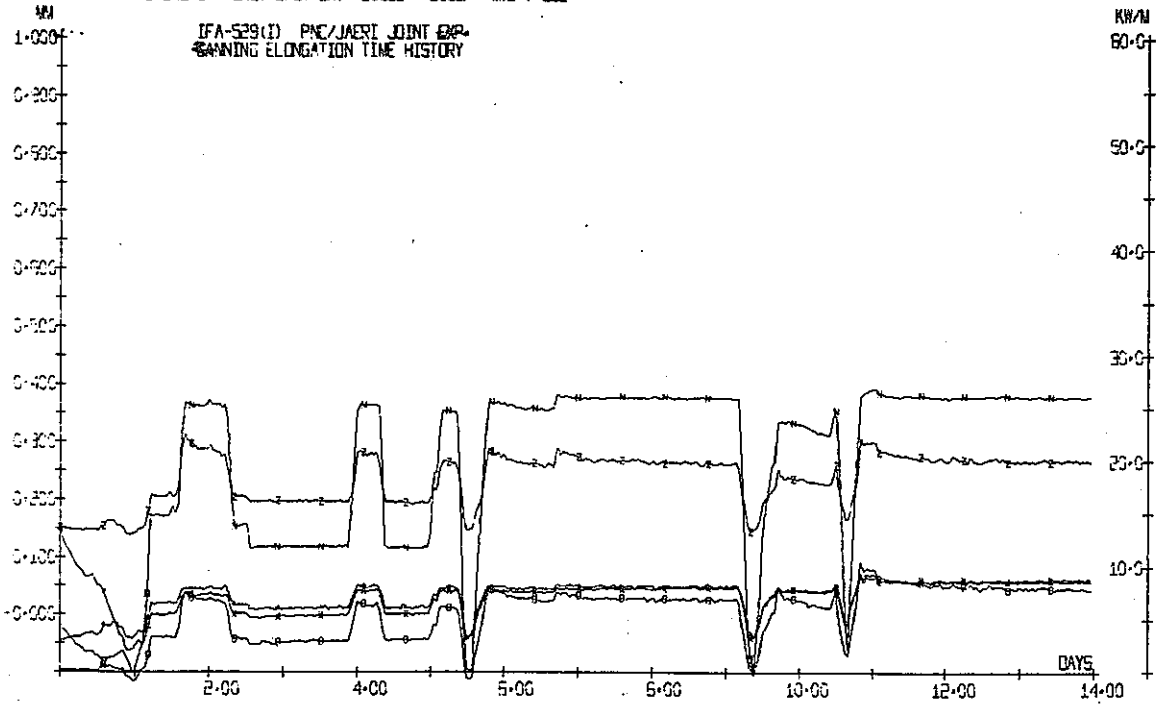

IFA-529(D) PNC/JAERI JOINT EXP.
 CANNING ELONGATION TIME HISTORY

ARG= DAY 0 EC-1 EC-2 EC-3 EC-4 ALHRU

*

付 録 6

I F A - 529 計 装 デ ー タ

～ E F (燃 料 ス タ ッ ク 長 伸 び) デ ー タ ～

ロッド7, ロッド9, ロッド10

OECD HALDEN REACTOR PROJECT
 DATA FROM 1 JULY80 0 HRS TO 14 JULY80 23:45 HRS
 BURN-UP AT THE END OF FIRST/LAST DAY 7.339 MW/D/T UO2

PLOT 124

IFA-529(D) PNC/JAREI JOINT EXP.
 FUEL ELONGATION TIME HISTORY

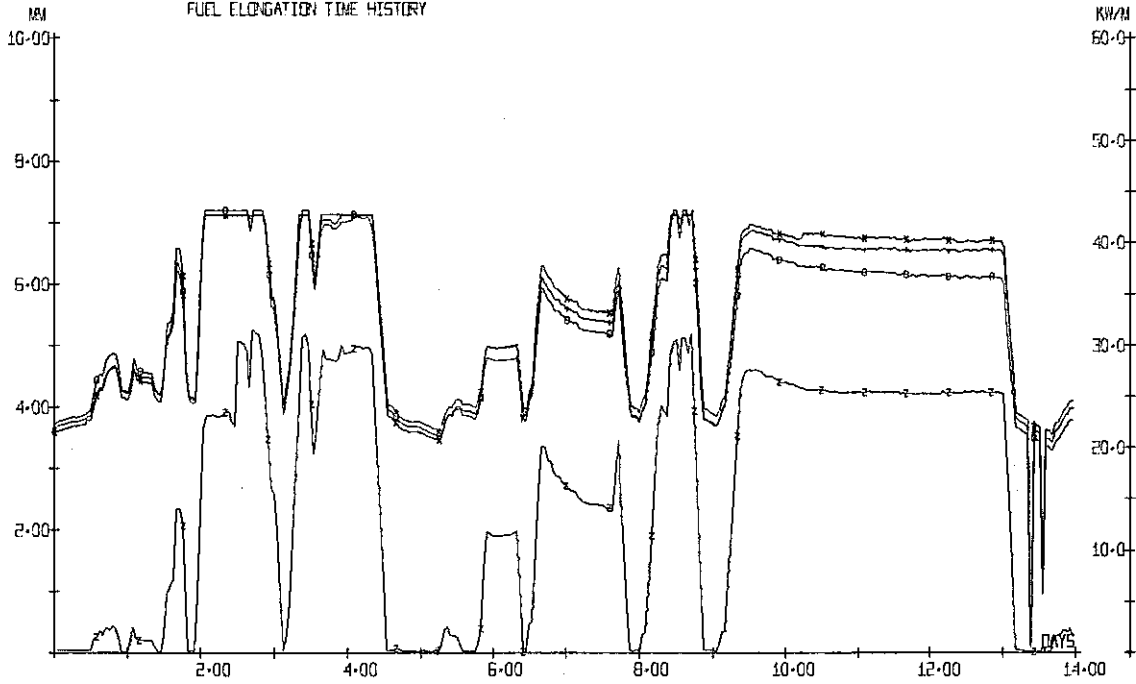

ARG= DAY ○ EF-1 □ EF-2 × EF-3 * ALHR *

OECD HALDEN REACTOR PROJECT
 DATA FROM 15 JULY80 0 HRS TO 28 JULY80 23:45 HRS
 BURN-UP AT THE END OF FIRST/LAST DAY 376.707 MW/D/T UO2

PLOT 124

IFA-529(D) PNC/JAREI JOINT EXP.
 FUEL ELONGATION TIME HISTORY

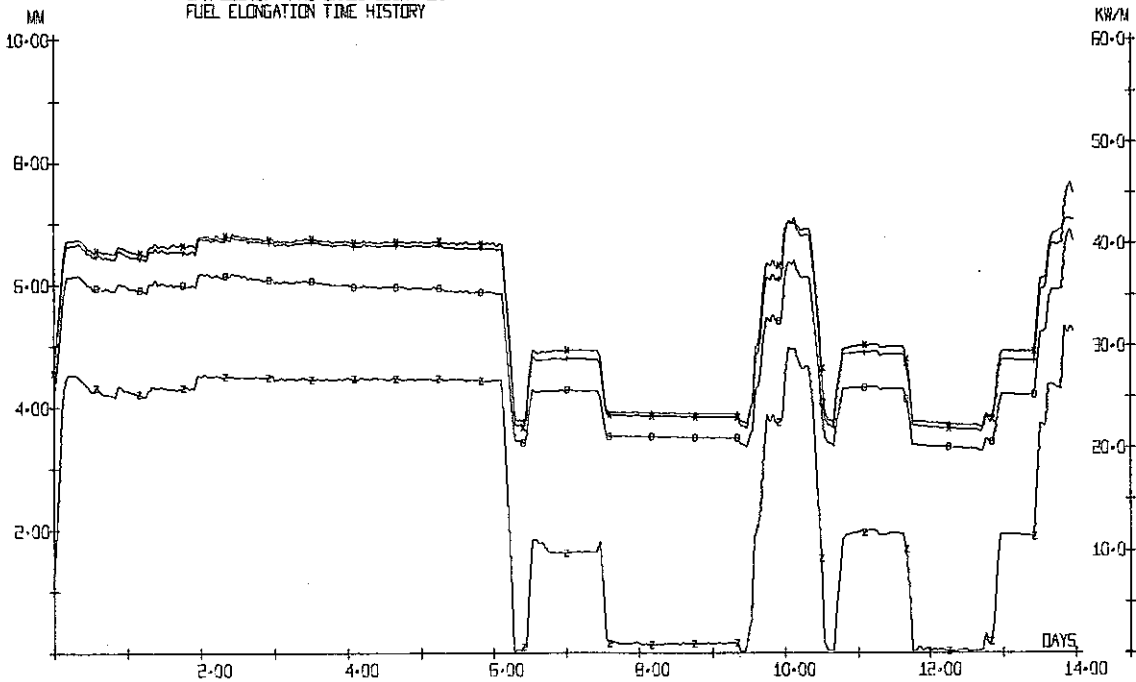

ARG= DAY ○ EF-1 □ EF-2 × EF-3 * ALHR *

OECD HALDEN REACTOR PROJECT
 DATA FROM 29 JULY 80 0 HRS TO 11 AUG 80 23:45 HRS
 BURN-UP AT THE END OF FIRST/LAST DAY 73% 1131 MW/D/T UO2

PLOT 124

IFA-529(D) PNC/JAREI JOINT EXP.
 FUEL ELONGATION TIME HISTORY

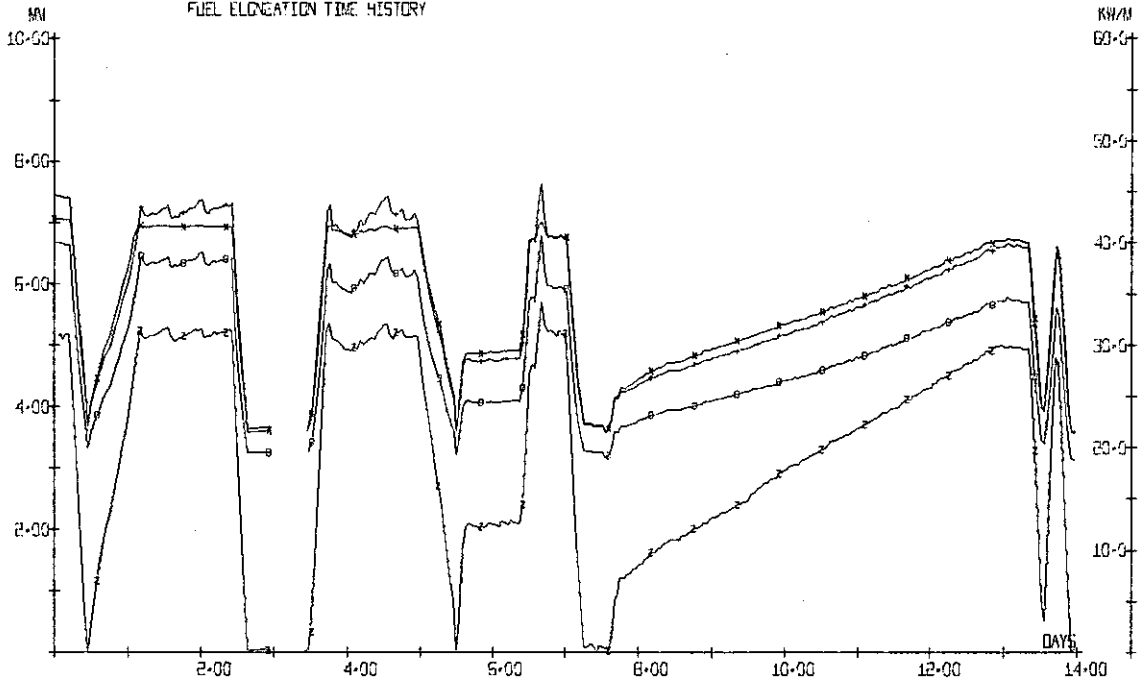

ARG= DAY o- EF-1 *- EF-2 x- EF-3 z- ALHR

*

OECD HALDEN REACTOR PROJECT
 DATA FROM 12 AUG 80 0 HRS TO 17 AUG 80 23:45 HRS
 BURN-UP AT THE END OF FIRST/LAST DAY 117% 1291 MW/D/T UO2

PLOT 124

IFA-529(D) PNC/JAREI JOINT EXP.
 FUEL ELONGATION TIME HISTORY

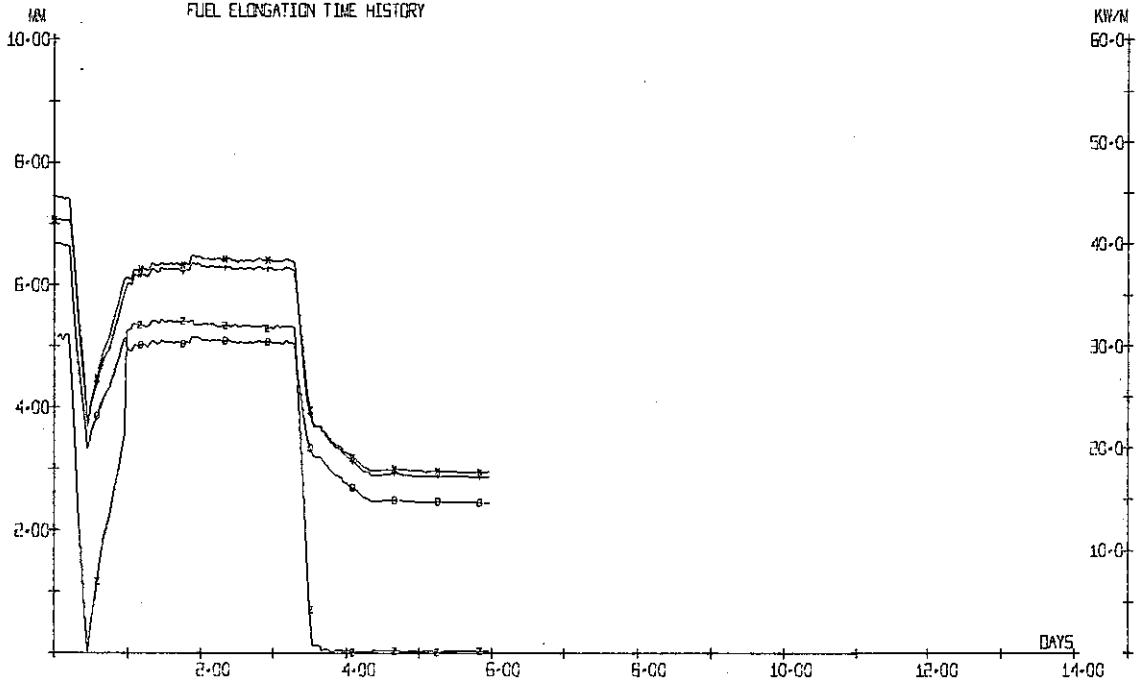

ARG= DAY o- EF-1 *- EF-2 x- EF-3 z- ALHR

*

CEG HALDEN REACTOR PROJECT
 DATA FROM 10 SEPT80 0 HRS TO 23 SEPT80 2345 HRS
 BURN-UP AT THE END OF FIRST/LAST DAY 951. 1272 MWDT UO2

FLOT 124

IFA-529(1) PNC/JAREI JOINT EXP.
 FUEL ELONGATION TIME HISTORY

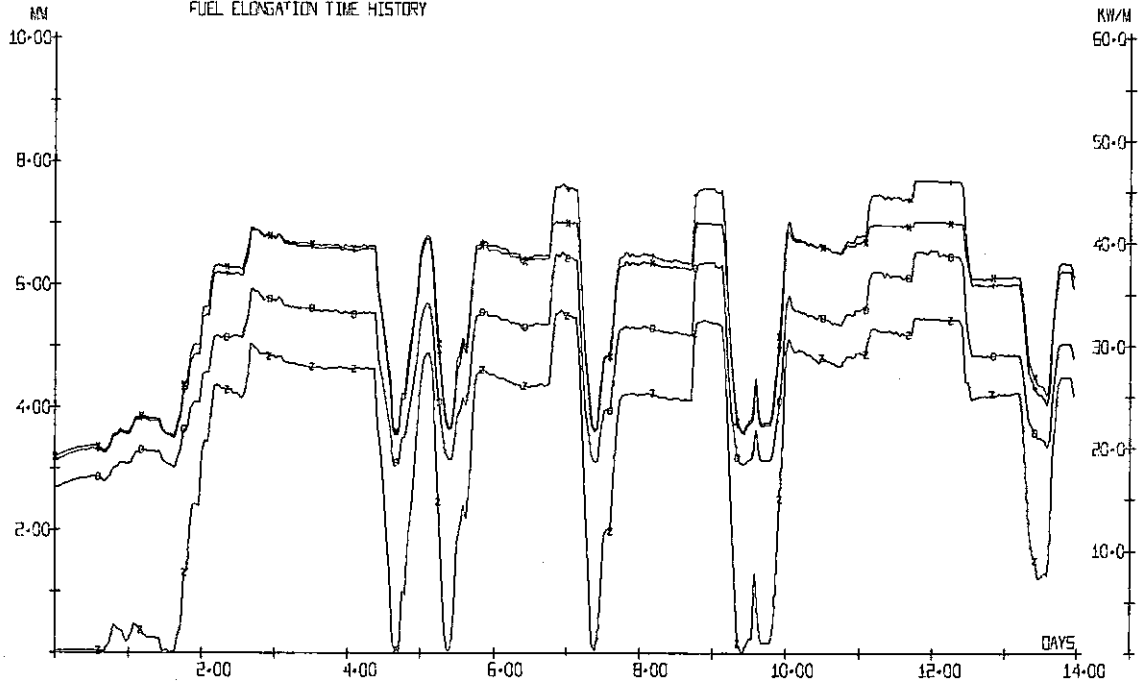

ARG= DAY o= EF-1 .. EF-2 * EF-3 z= ALHR

*

CEG HALDEN REACTOR PROJECT
 DATA FROM 24 SEPT80 0 HRS TO 30 SEPT80 2345 HRS
 BURN-UP AT THE END OF FIRST/LAST DAY 1284. 1411 MWDT UO2

FLOT 124

IFA-529(1) PNC/JAREI JOINT EXP.
 FUEL ELONGATION TIME HISTORY

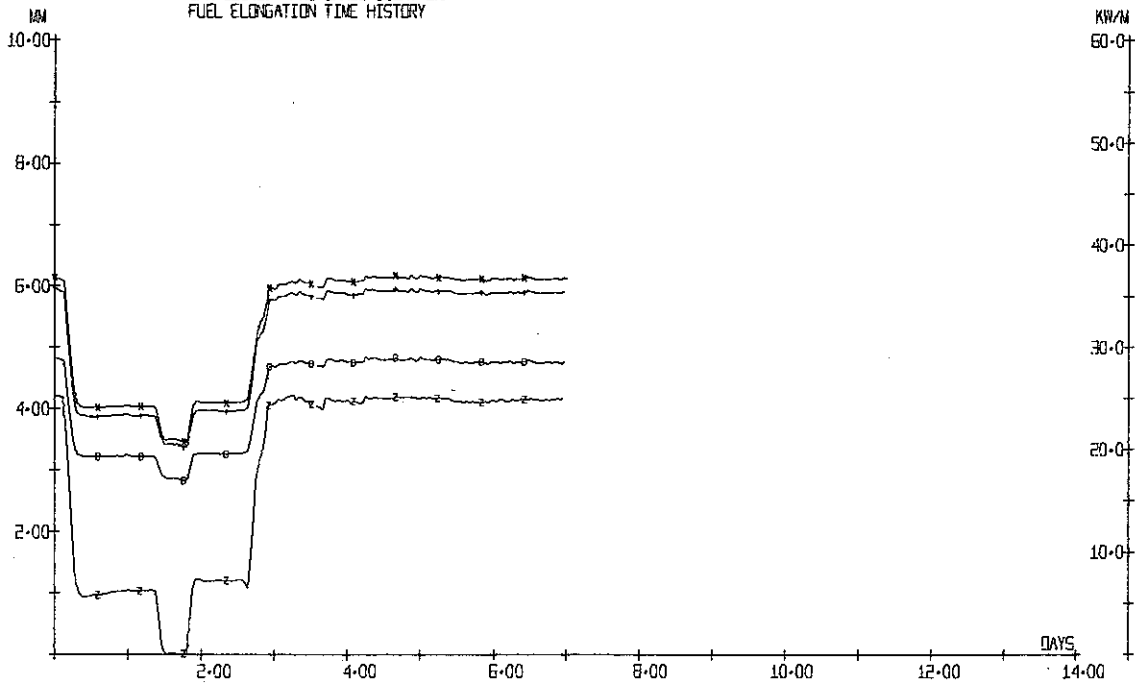

ARG= DAY o= EF-1 .. EF-2 * EF-3 z= ALHR

*

OECD HALDEN REACTOR PROJECT
 DATA FROM 1 OCT 80 0 HRS TO 5 OCT 80 2345 HRS
 BURN-UP AT THE END OF FIRST/LAST DAY 1.430 1.478 MWD/T UO₂

PLOT 124

IFA-529(I) PNC/JAREI JOINT EXP.
 FUEL ELONGATION TIME HISTORY

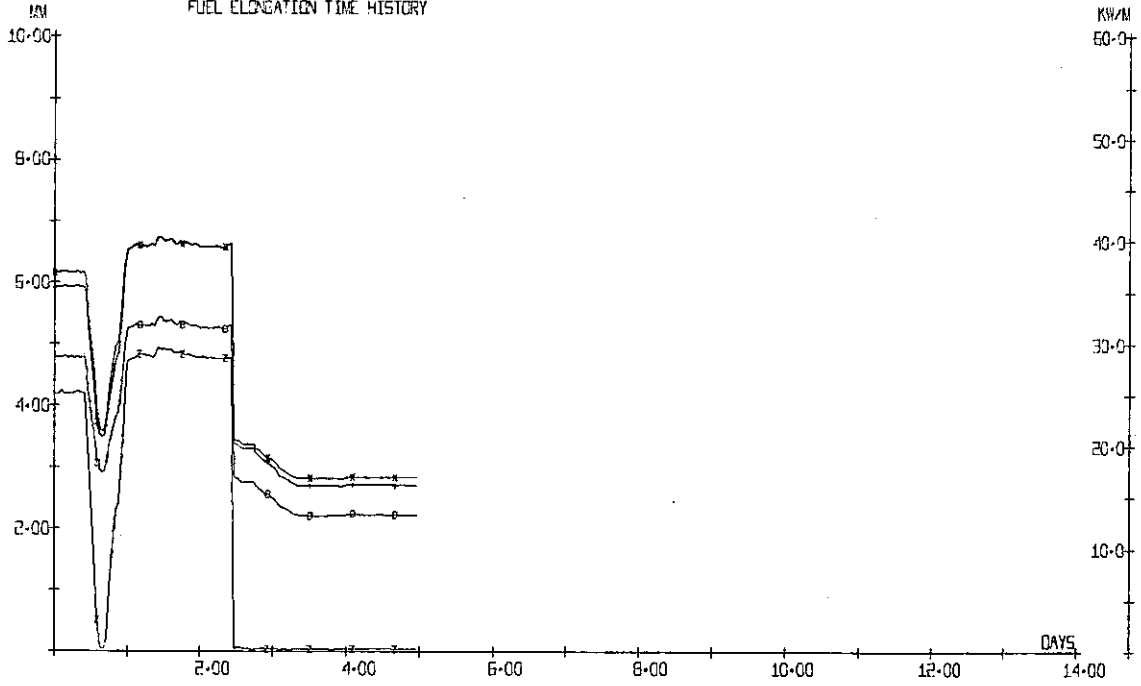

ARG= DAY o- EF-1 -- EF-2 x- EF-3 z- ALHR

*

OECD HALDEN REACTOR PROJECT
 DATA FROM 12 DEC 80 0 HRS TO 23 DEC 80 1800 HRS
 BURN-UP AT THE END OF FIRST/LAST DAY 1.491 1.700 MWD/T UO₂

PLOT 124

IFA-529(I) PNC/JAREI JOINT EXP.
 FUEL ELONGATION TIME HISTORY

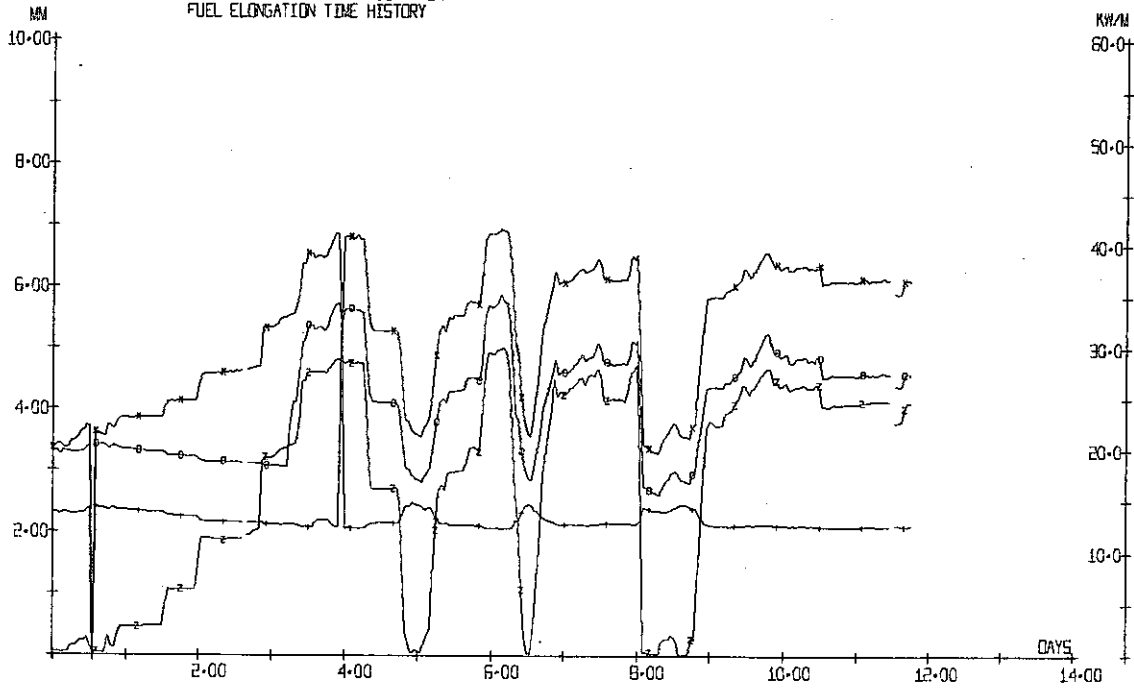

ARG= DAY o- EF-1 -- EF-2 x- EF-3 z- ALHR

*

WECU HALDEN REACTOR PROJECT
 DATA FROM 1 JAN 81 0 HRS TO 14 JAN 81 2345 HRS
 BURN-UP AT THE END OF FIRST/LAST DAY 1926 -99 MWDT UO2

PLOT 124

IFA-529(U) PNC/JAREI JOINT EXP.
 FUEL ELONGATION TIME HISTORY

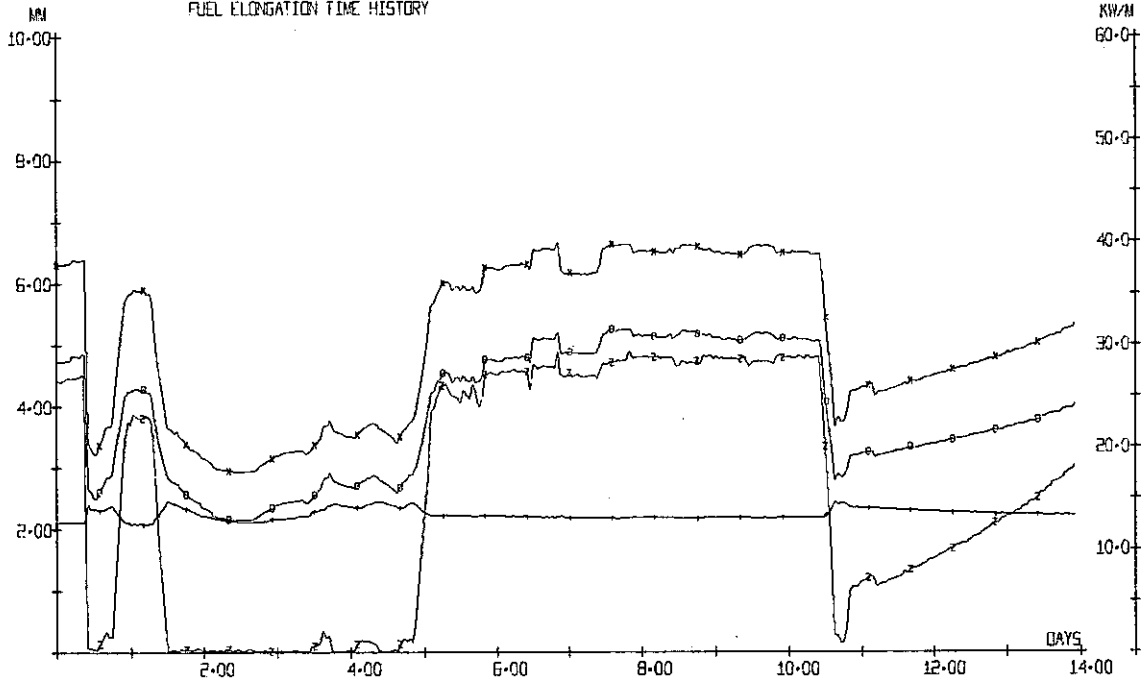

ARG= DAY o- EF-1 *- EF-2 x- EF-3 z- ALHR

*

WECU HALDEN REACTOR PROJECT
 DATA FROM 15 JAN 81 0 HRS TO 19 JAN 81 2345 HRS
 BURN-UP AT THE END OF FIRST/LAST DAY 1936 -99 MWDT UO2

PLOT 124

IFA-529(U) PNC/JAREI JOINT EXP.
 FUEL ELONGATION TIME HISTORY

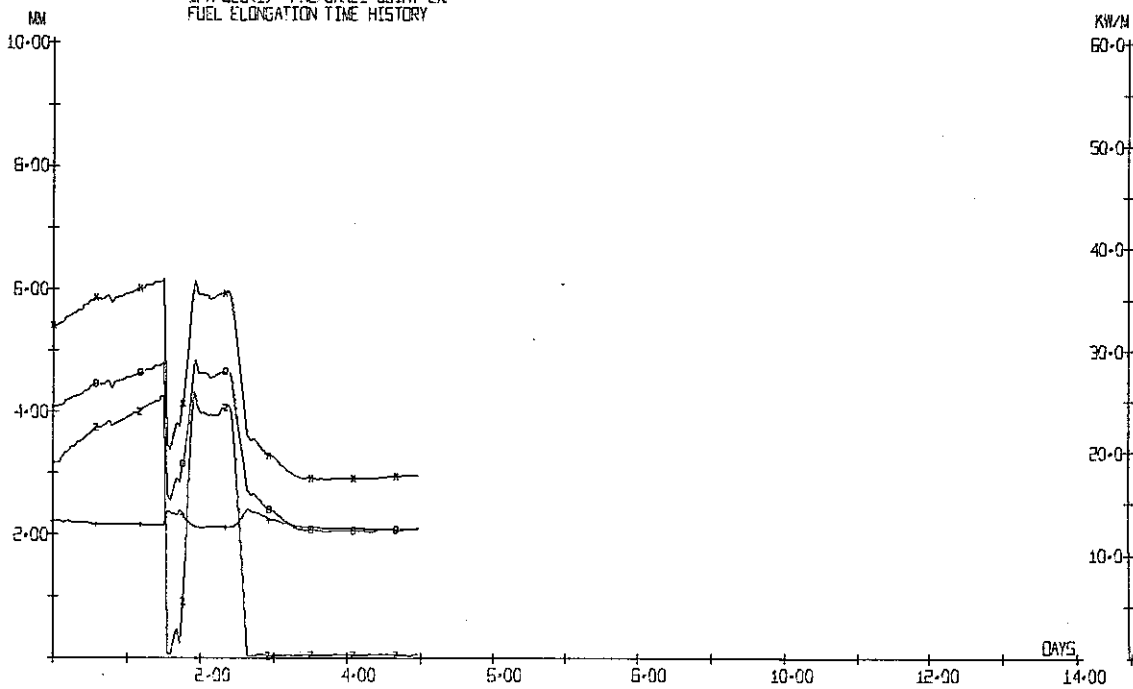

ARG= DAY o- EF-1 *- EF-2 x- EF-3 z- ALHR

*

OECD HALDEN REACTOR PROJECT
 DATA FROM 29 JAN 81 0 HRS TO 6 FEB 81 23:45 HRS
 BURN-UP AT THE END OF FIRST/LAST DAY -99 2471 MWDT UO2

PLOT 124

IFA-529(D) PNC/JAREI JOINT EXP.
 FUEL ELONGATION TIME HISTORY

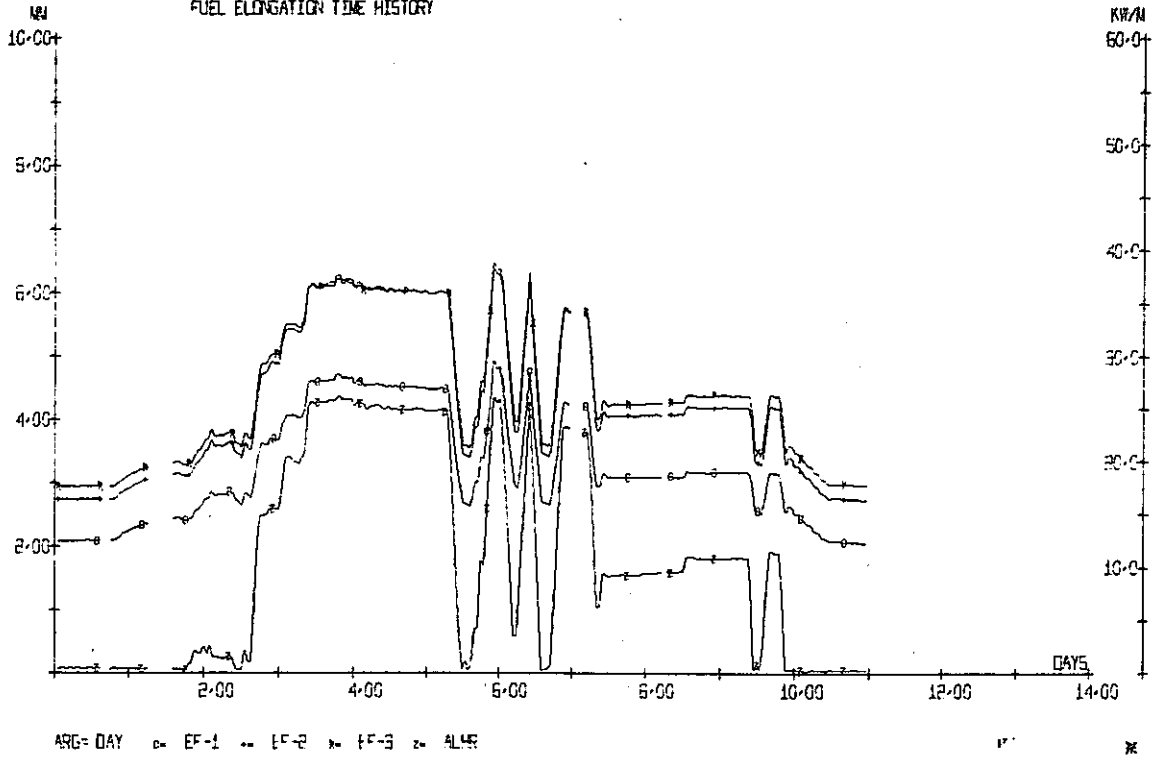

OECD HALDEN REACTOR PROJECT
 DATA FROM 1 APR 81 0 HRS TO 14 APR 81 23:45 HRS
 BURN-UP AT THE END OF FIRST/LAST DAY 2471 2564 MWDT UO2

PLOT 124

IFA-529(D) PNC/JAREI JOINT EXP.
 FUEL ELONGATION TIME HISTORY

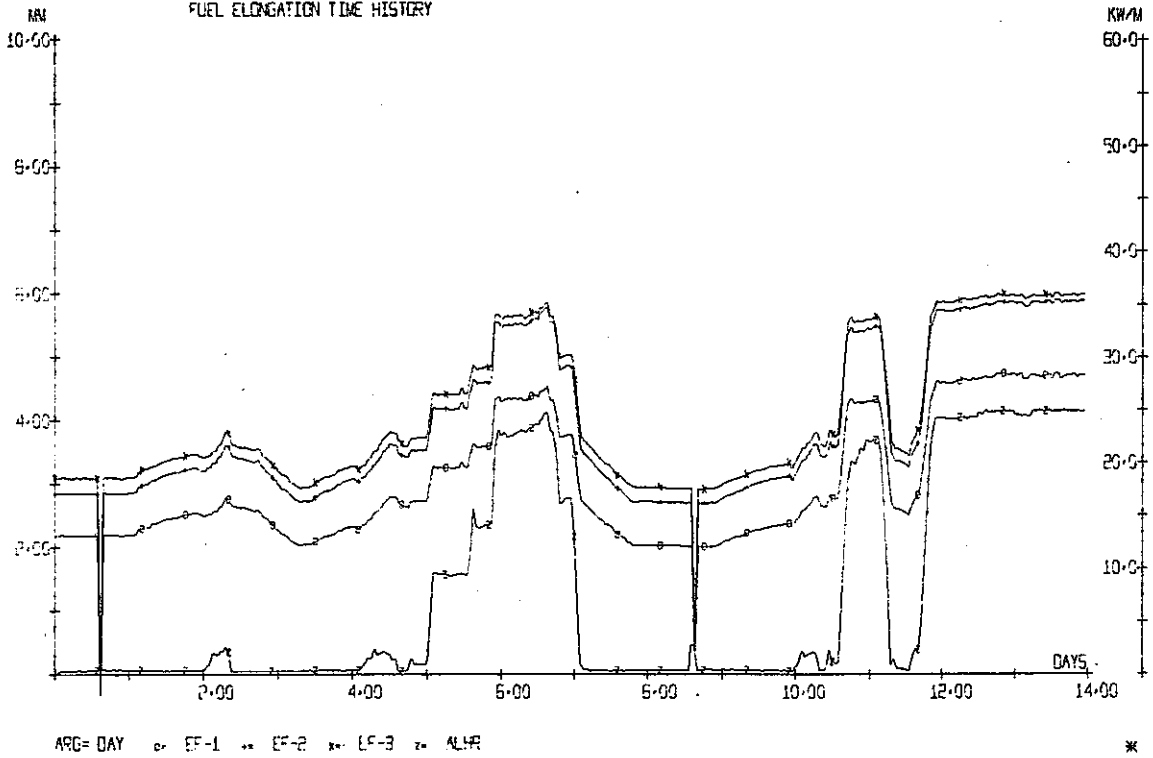

OECD HALDEN REACTOR PROJECT
 DATA FROM 15 APR 91 0 HRS TO 26 APR 91 23:45 HRS
 BURN-UP AT THE END OF FIRST/LAST DAY 2613 2921 MWDT UOE

PLOT 124

IFA-529(1) PNC/JAREC JOINT EXP.
 FUEL ELONGATION TIME HISTORY

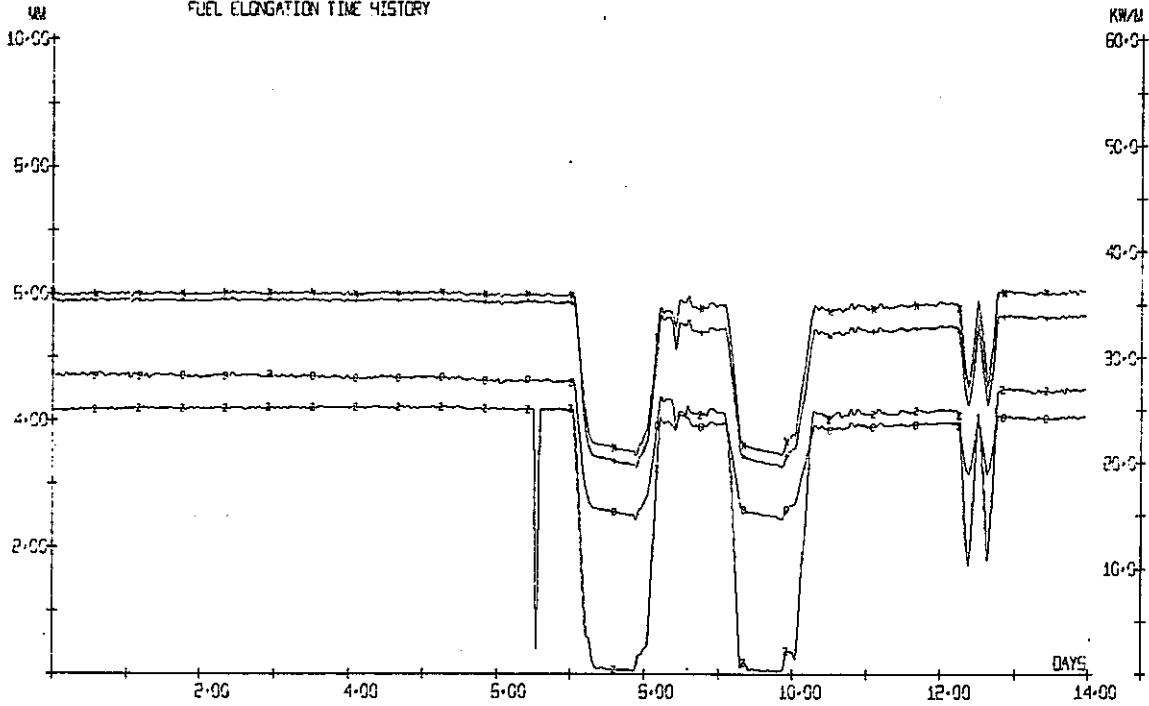

ARG= DAY o EF-1 * EF-2 x EF-3 z ALHR

OECD HALDEN REACTOR PROJECT
 DATA FROM 29 APR 91 0 HRS TO 12 MAY 91 23:45 HRS
 BURN-UP AT THE END OF FIRST/LAST DAY 2951 3231 MWDT UOE

PLOT 124

IFA-529(1) PNC/JAREC JOINT EXP.
 FUEL ELONGATION TIME HISTORY

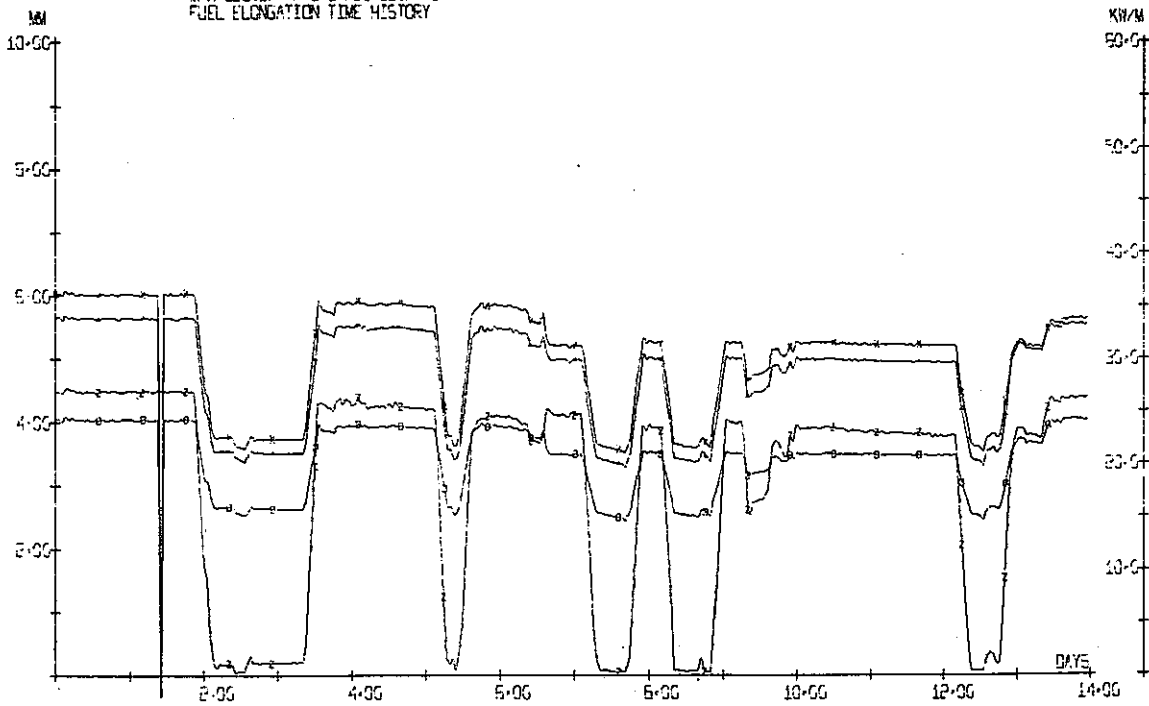

ARG= DAY o EF-1 * EF-2 x EF-3 z ALHR

OECO HALDEN REACTOR PROJECT
 DATA FROM 13 MAY 81 0 HRS TO 25 MAY 81 2345 HRS
 BURN-UP AT THE END OF FIRST/LAST DAY 3232 3557 MWD/T UO2

PLOT 124

IFA-529(D) PNC/JAREI JOINT EXP.
 FUEL ELONGATION TIME HISTORY

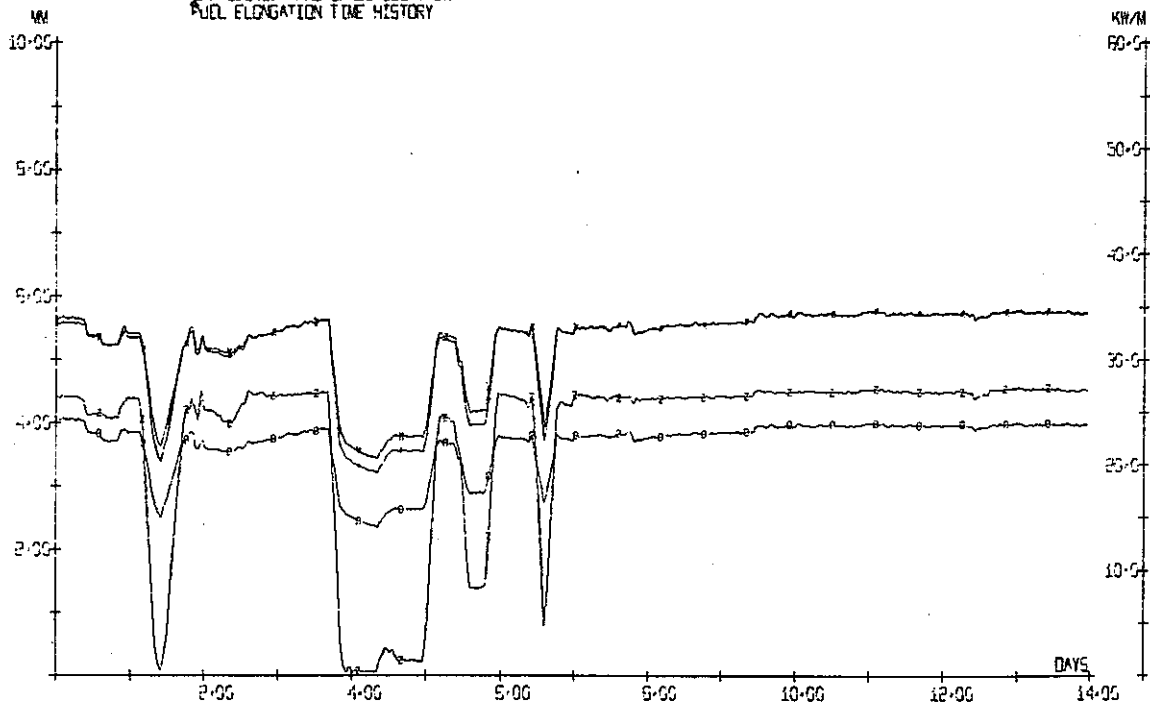

ARG= DAY ▫ EF-1 ◯ EF-2 * EF-3 z ALHR

*

OECO HALDEN REACTOR PROJECT
 DATA FROM 27 MAY 81 0 HRS TO 6 JUNE 81 2345 HRS
 BURN-UP AT THE END OF FIRST/LAST DAY 3567 3662 MWD/T UO2

PLOT 124

IFA-529(D) PNC/JAREI JOINT EXP.
 FUEL ELONGATION TIME HISTORY

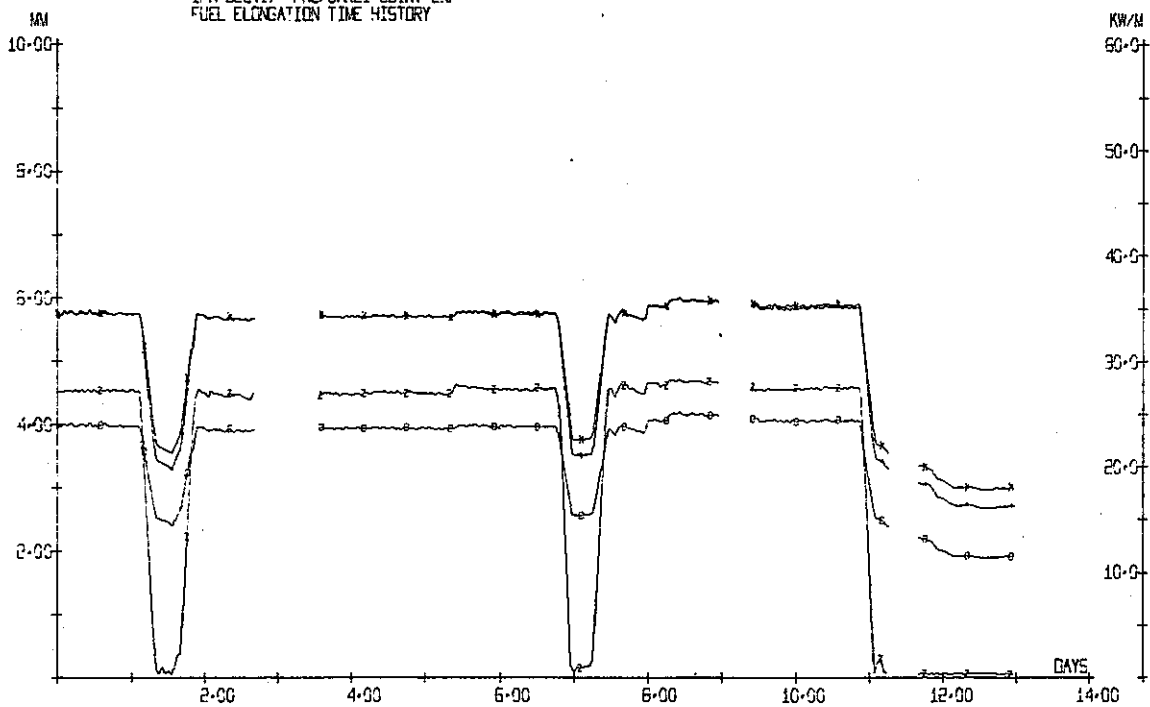

ARG= DAY ▫ EF-1 ◯ EF-2 * EF-3 z ALHR

*

OECD HALDEN REACTOR PROJECT
DATA FROM 23 JUNE 81 0 HRS TO 30 JUNE 81 23:45 HRS
BURN-UP AT THE END OF FIRST/LAST DAY 3552 4051 MW/D T UO2

PLOT 124

IFA-529(U) PNC/JAREI JOINT EXP.
FUEL ELONGATION TIME HISTORY

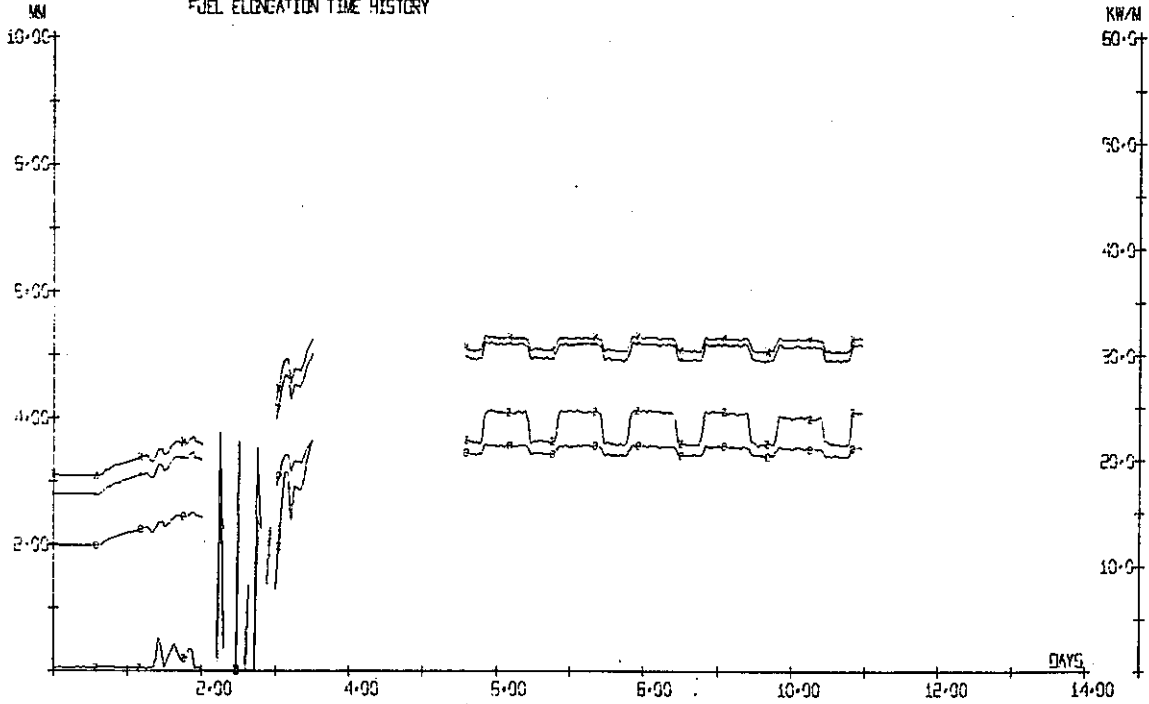

ARG= DAY * EF-1 ** EF-2 *** EF-3 * ALHR

*

OECD HALDEN REACTOR PROJECT
DATA FROM 1 JULY 81 0 HRS TO 14 JULY 81 23:45 HRS
BURN-UP AT THE END OF FIRST/LAST DAY 4087 4468 MW/D T UO2

PLOT 124

IFA-529(U) PNC/JAREI JOINT EXP.
FUEL ELONGATION TIME HISTORY

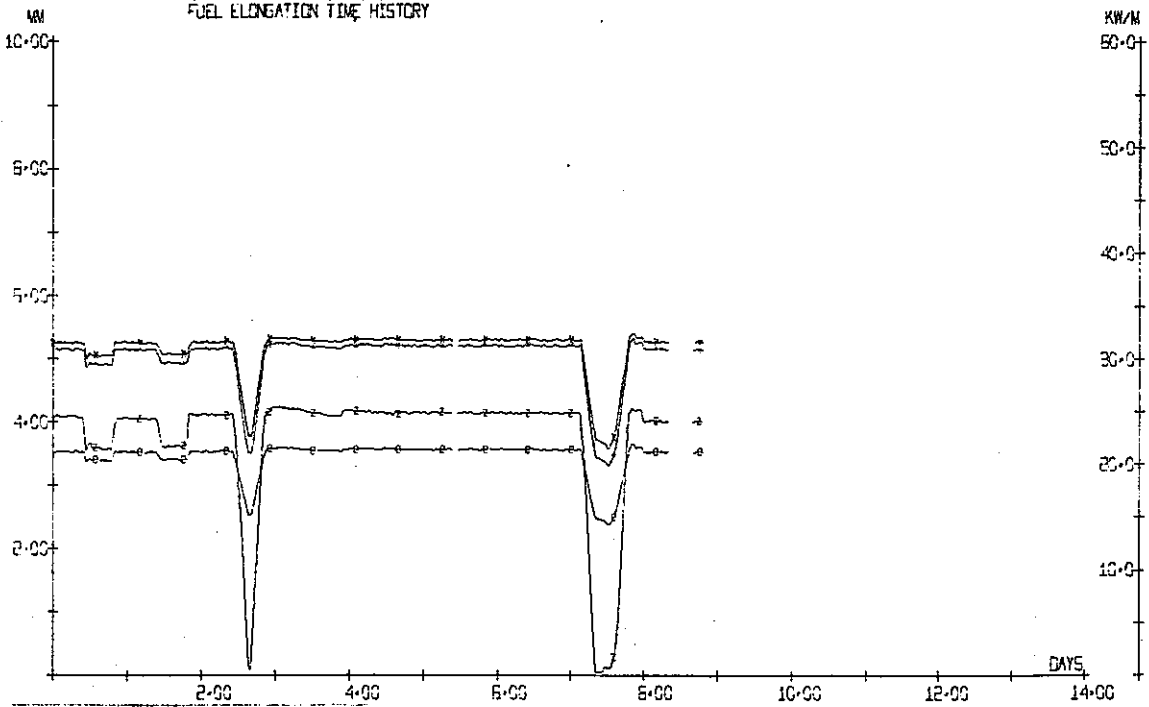

ARG= DAY * EF-1 ** EF-2 *** EF-3 * ALHR

*

OCEC HALDEN REACTOR PROJECT
 DATA FROM 15 JULY 81 0 HRS TO 25 JULY 81 23:45 HRS
 BURN-UP AT THE END OF FIRST/LAST DAY 4472 4820 MW/D/T UOZ

PLOT 124

IFA-523(1) PNC/JAERI JOINT EXP.
 FUEL ELONGATION TIME HISTORY

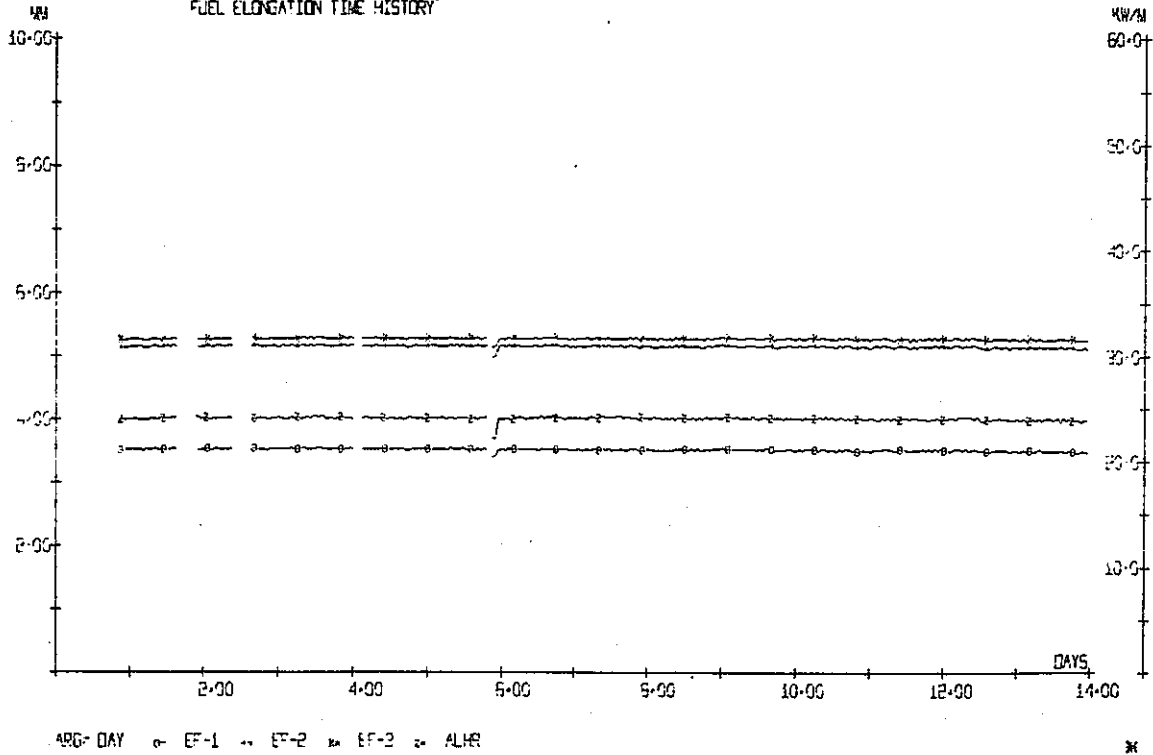

OCEC HALDEN REACTOR PROJECT
 DATA FROM 29 JULY 81 0 HRS TO 11 AUG 81 23:45 HRS
 BURN-UP AT THE END OF FIRST/LAST DAY 4846 5327 MW/D/T UOZ

PLOT 124

IFA-523(1) PNC/JAERI JOINT EXP.
 FUEL ELONGATION TIME HISTORY

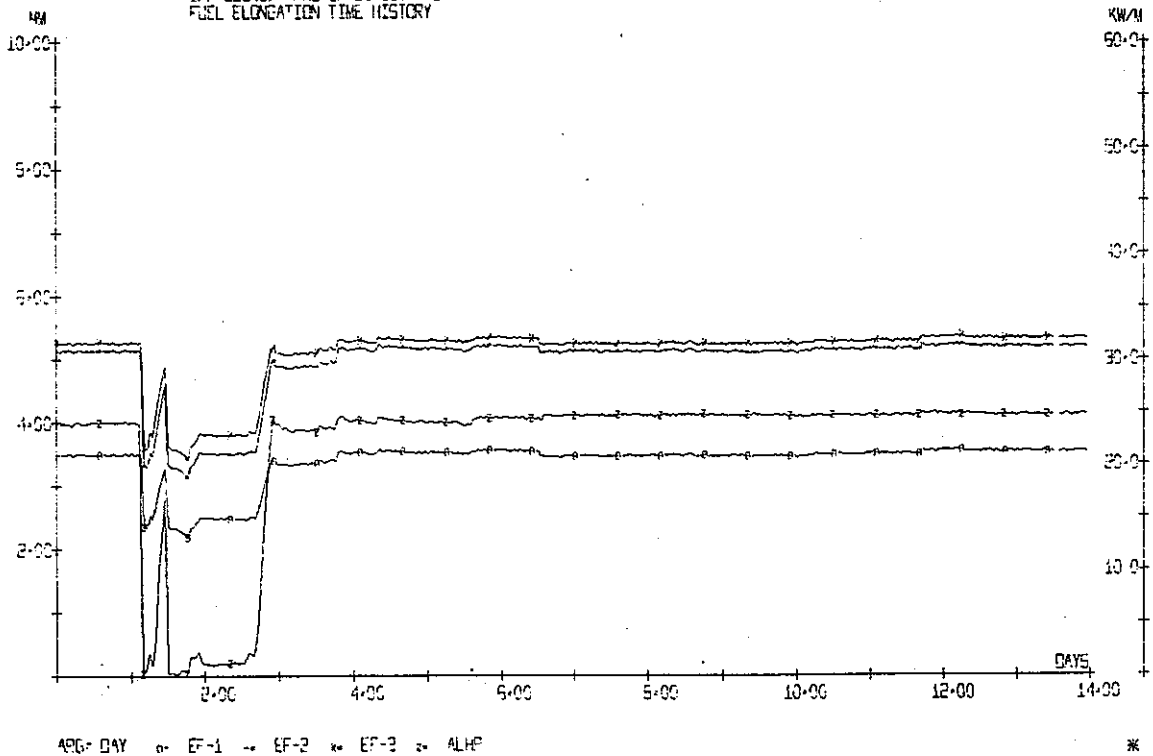

OECD HALDEN REACTOR PROJECT
DATA FROM 12 AUG 81 0 HRS TO 22 AUG 81 2345 HRS
BURN-UP AT THE END OF FIRST/LAST DAY 5375 5375 MWDT UO2

PLOT 124

IFA-523(L) PNC/JAREI JOINT EXP.
FUEL ELONGATION TIME HISTORY

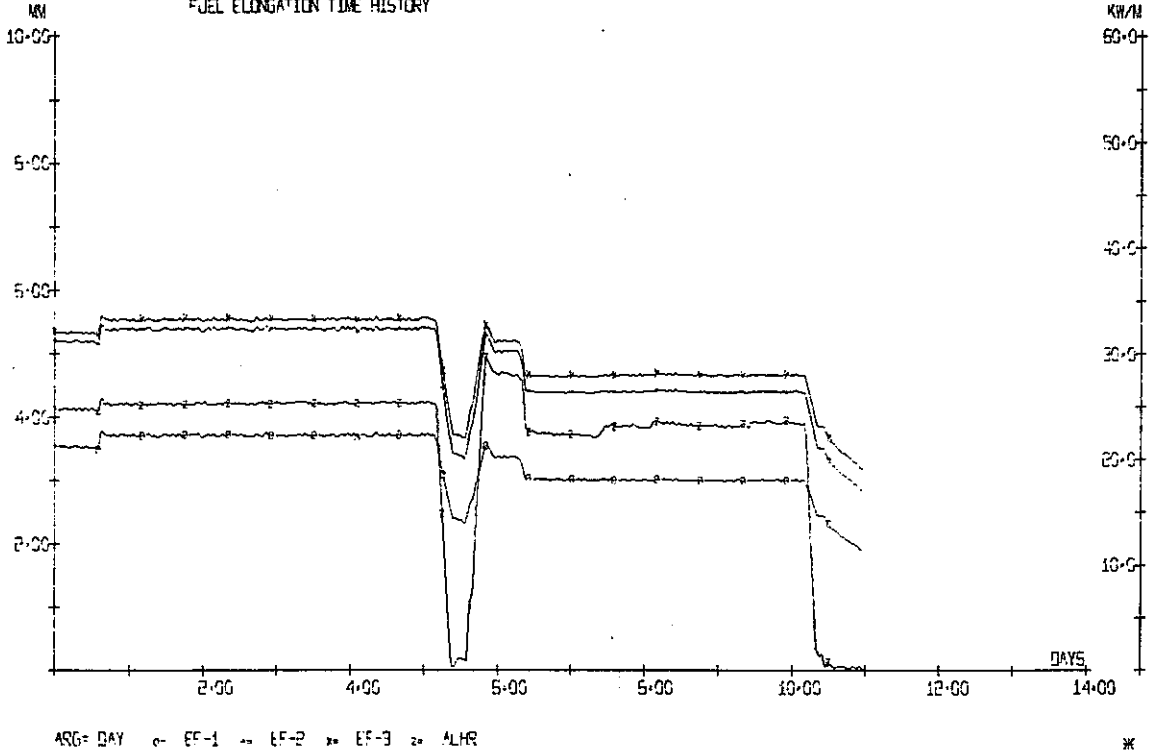

OECD HALDEN REACTOR PROJECT
DATA FROM 1 SEPT 81 0 HRS TO 14 SEPT 81 2345 HRS
BURN-UP AT THE END OF FIRST/LAST DAY 5377 5675 MWDT UO2

PLOT 124

IFA-523(L) PNC/JAREI JOINT EXP.
FUEL ELONGATION TIME HISTORY

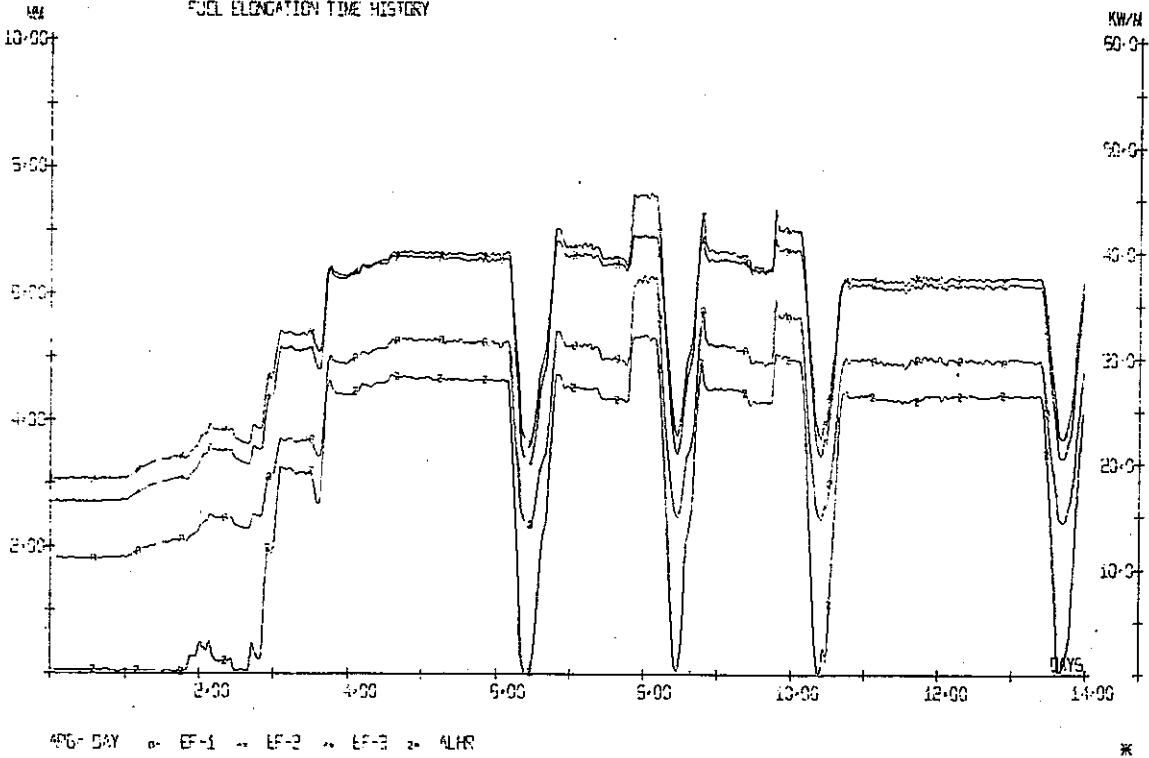

OECD HALDEN REACTOR PROJECT
 DATA FROM 15 SEPT 81 0 HRS TO 25 SEPT 81 23:45 HRS
 BURN-UP AT THE END OF FIRST/LAST DAY 5925 6325 MW/D/T UOE

PLOT 124

IFA-523(D) PNC/JAREI JOINT EXP.
 FUEL ELONGATION TIME HISTORY

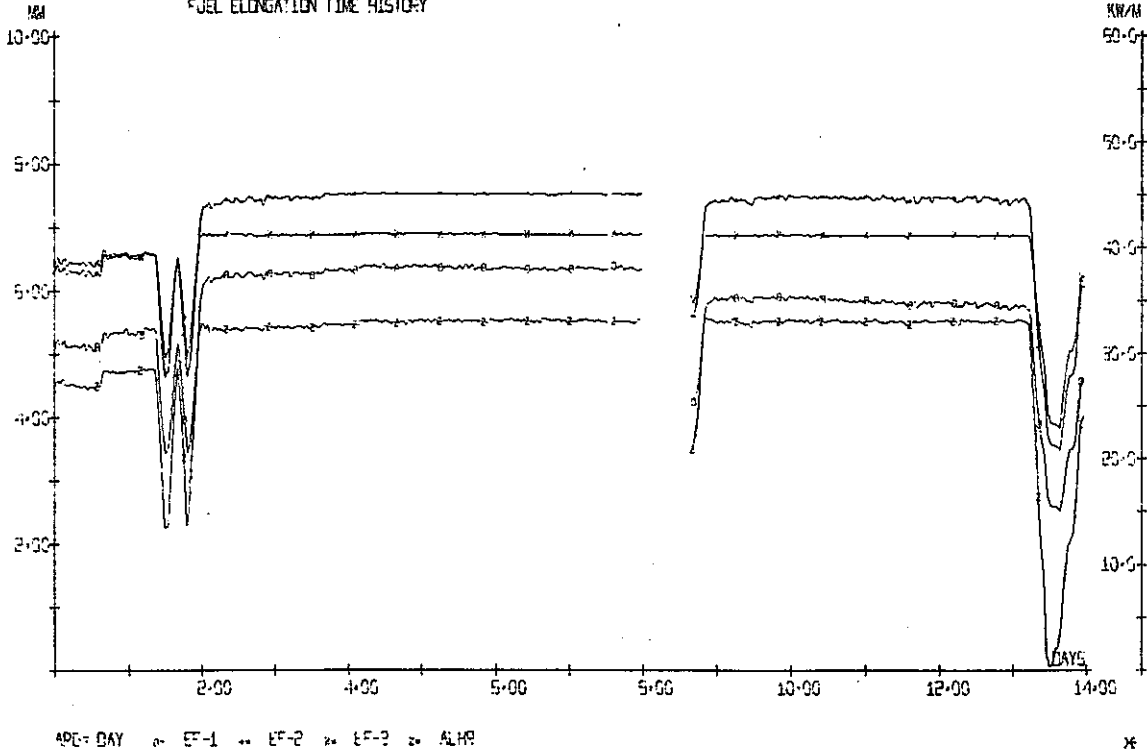

OECD HALDEN REACTOR PROJECT
 DATA FROM 29 SEPT 81 0 HRS TO 4 OCT 81 23:45 HRS
 BURN-UP AT THE END OF FIRST/LAST DAY 6352 6413 MW/D/T UOE

PLOT 124

IFA-529(D) PNC/JAREI JOINT EXP.
 FUEL ELONGATION TIME HISTORY

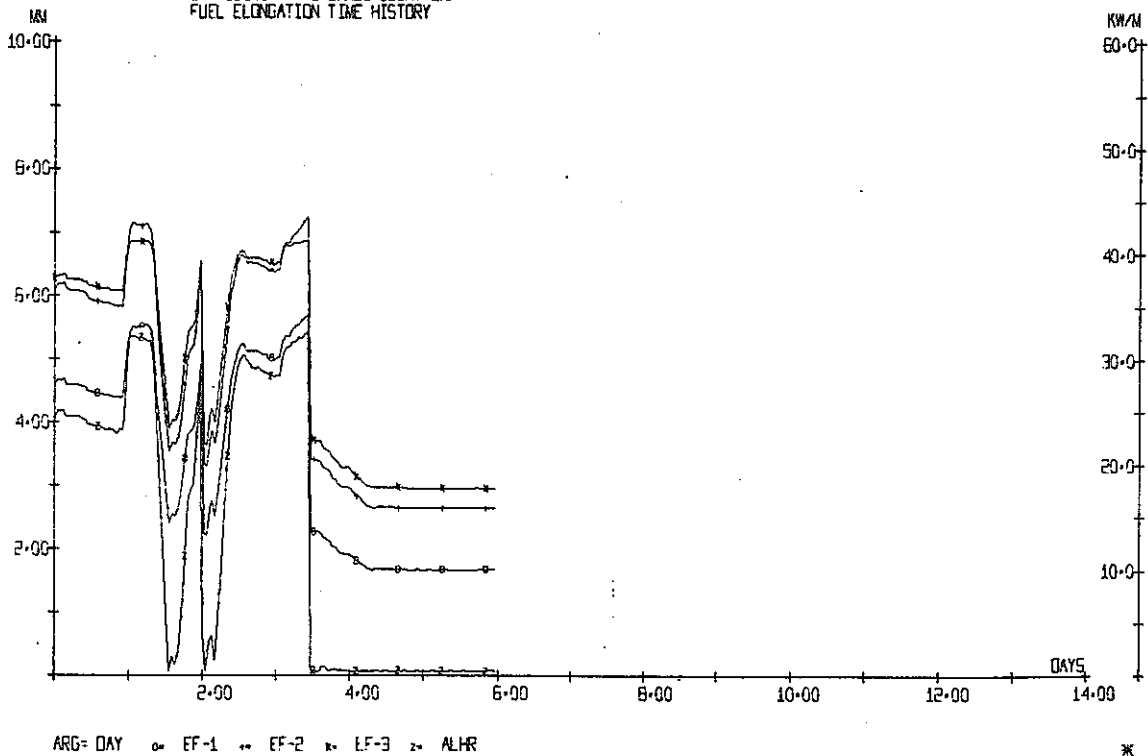

OECD HALDEN REACTOR PROJECT
 DATA FROM 24 DEC 81 0 HRS TO 31 DEC 81 23:45 HRS
 BURN-UP AT THE END OF FIRST/LAST DAY 6417 5525 MW/D/T UO2

PLOT 124

IFA-523(1) PNC/JAREI JOINT EXP.
 FUEL ELONGATION TIME HISTORY

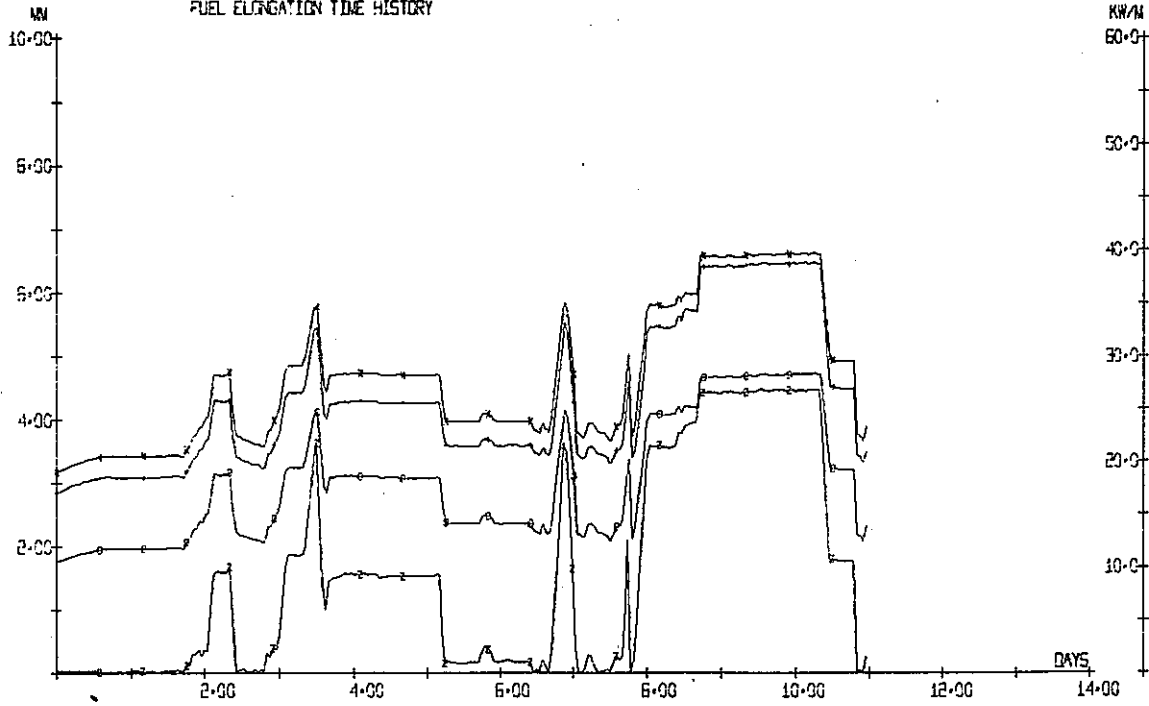

ARG= DAY o EF-1 -- EF-2 x EF-3 z ALHR *

OECD HALDEN REACTOR PROJECT
 DATA FROM 1 JAN 82 0 HRS TO 14 JAN 82 23:45 HRS
 BURN-UP AT THE END OF FIRST/LAST DAY 5531 5951 MW/D/T UO2

PLOT 124

IFA-523(1) PNC/JAREI JOINT EXP.
 FUEL ELONGATION TIME HISTORY

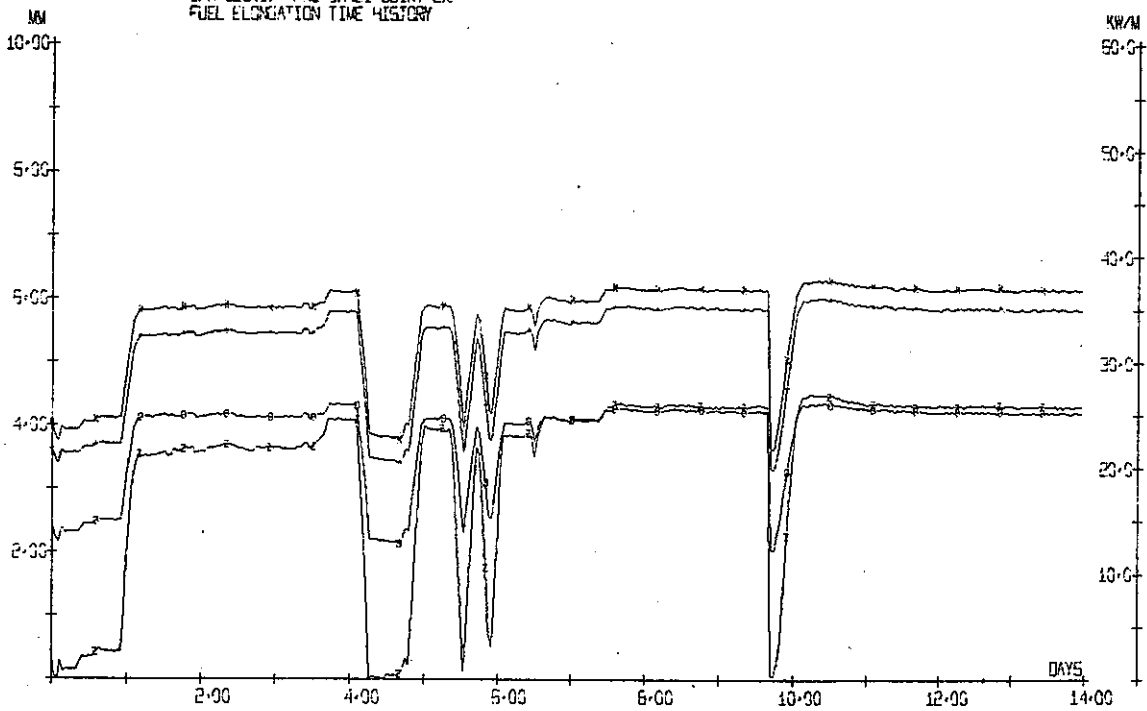

ARG= DAY o EF-1 -- EF-2 x EF-3 z ALHR *

OECD HALDEN REACTOR PROJECT
 DATA FROM 15 JAN 82 0 HRS TO 25 JAN 82 23:45 HRS
 BURN-UP AT THE END OF FIRST/LAST DAY 5653 2851 MWDT UOE

PLOT 124

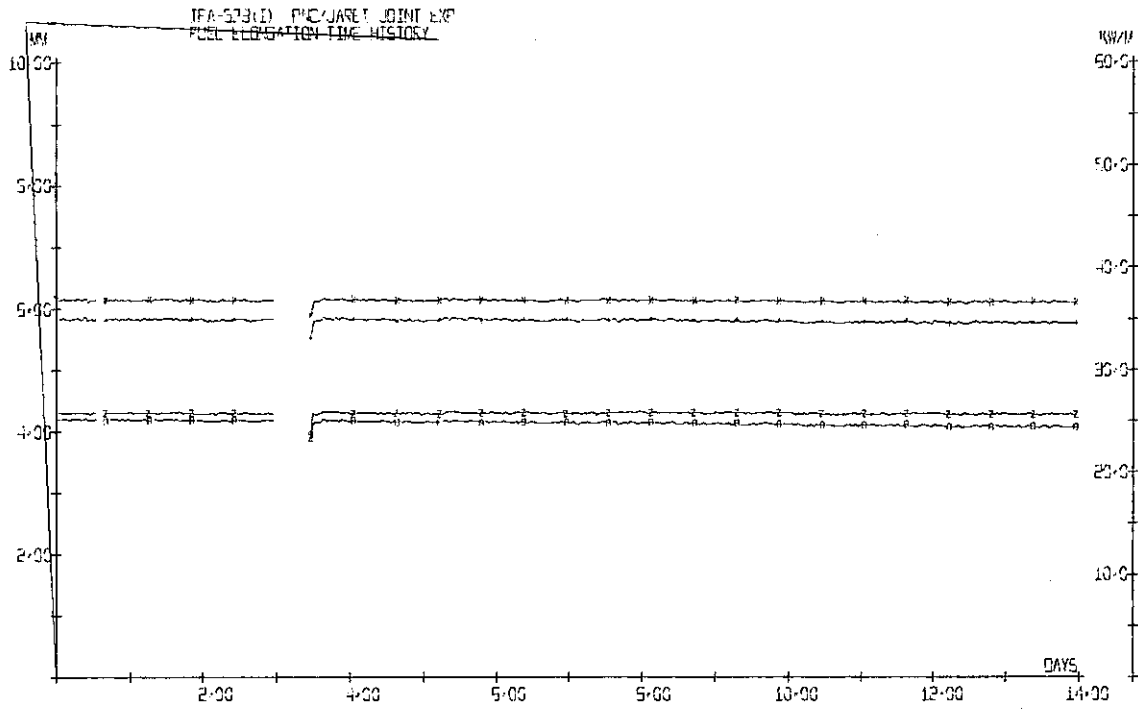

ARG= DAY o- EF-1 -- EF-2 x- EF-3 z- ALHR *

OECD HALDEN REACTOR PROJECT
 DATA FROM 31 JAN 82 0 HRS TO 13 FEB 82 23:45 HRS
 BURN-UP AT THE END OF FIRST/LAST DAY 7337 7517 MWDT UOE

PLOT 124

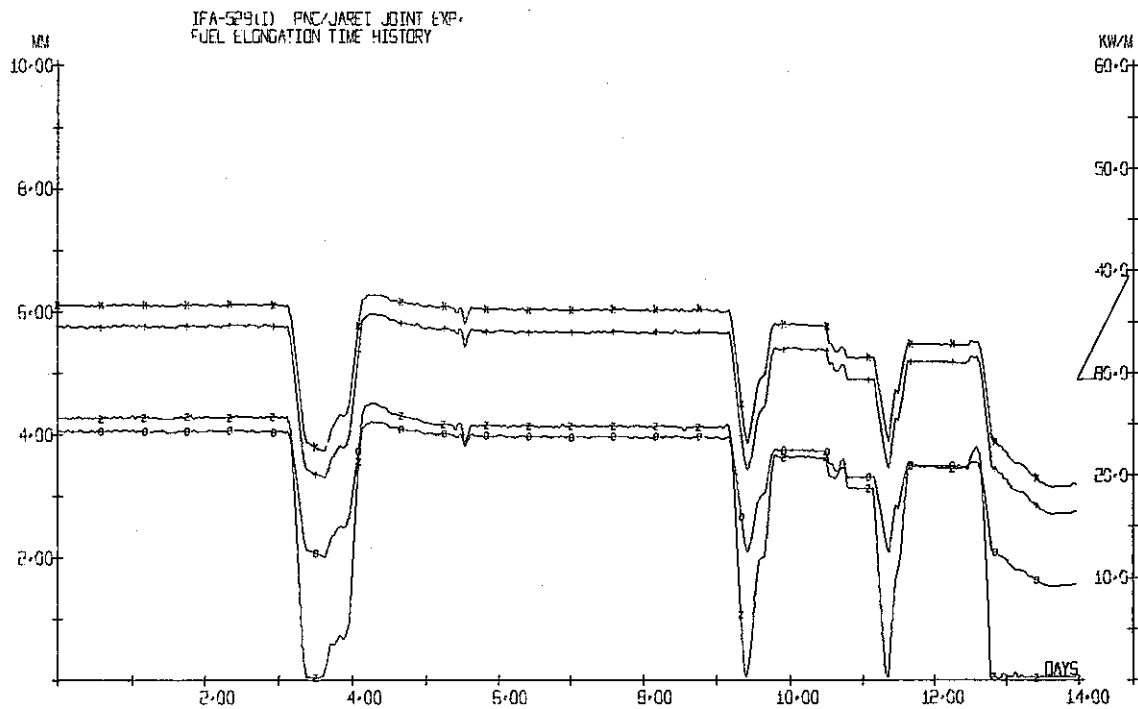

ARG= DAY o- EF-1 -- EF-2 x- EF-3 z- ALHR *

OECD HALDEN REACTOR PROJECT
DATA FROM 25 FEB 92 0 HRS TO 10 MAR 92 23:45 HRS
BURN-UP AT THE END OF FIRST/LAST DAY 7518 7943 MWDT UO2

PLOT 124

IFA-529(L) PNC/JAREI JOINT EXP.
FUEL ELONGATION TIME HISTORY

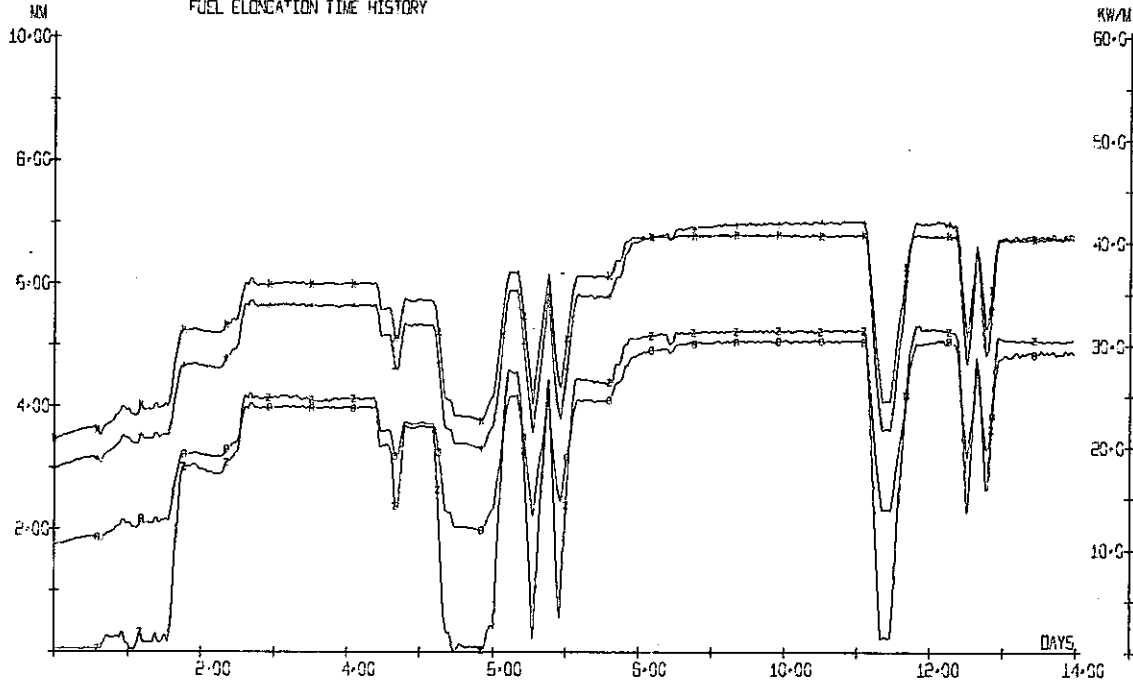

ARG= DAY o- EF-1 s- EF-2 x- EF-3 z- ALHR

*

OECD HALDEN REACTOR PROJECT
DATA FROM 11 MAR 92 0 HRS TO 24 MAR 92 23:45 HRS
BURN-UP AT THE END OF FIRST/LAST DAY 7551 8211 MWDT UO2

PLOT 124

IFA-529(L) PNC/JAREI JOINT EXP.
FUEL ELONGATION TIME HISTORY

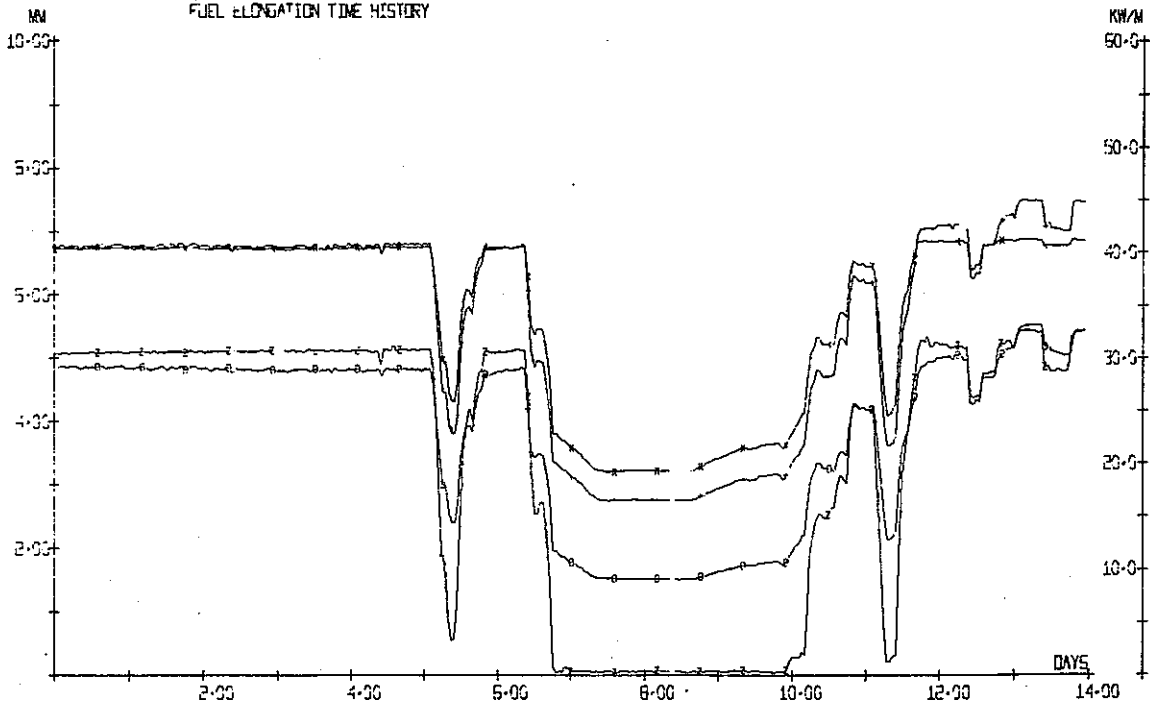

ARG= DAY o- EF-1 s- EF-2 x- EF-3 z- ALHR

*

OECD HALDEN REACTOR PROJECT
 DATA FROM 25 MAR 82 0 HRS TO 31 MAR 82 23 HRS
 BURN-UP AT THE END OF FIRST/LAST DAY 8306 6511 MWD/T UO2

PLOT 124

IFA-529(I) PNC/JAREI JOINT EXP.
 FUEL ELONGATION TIME HISTORY

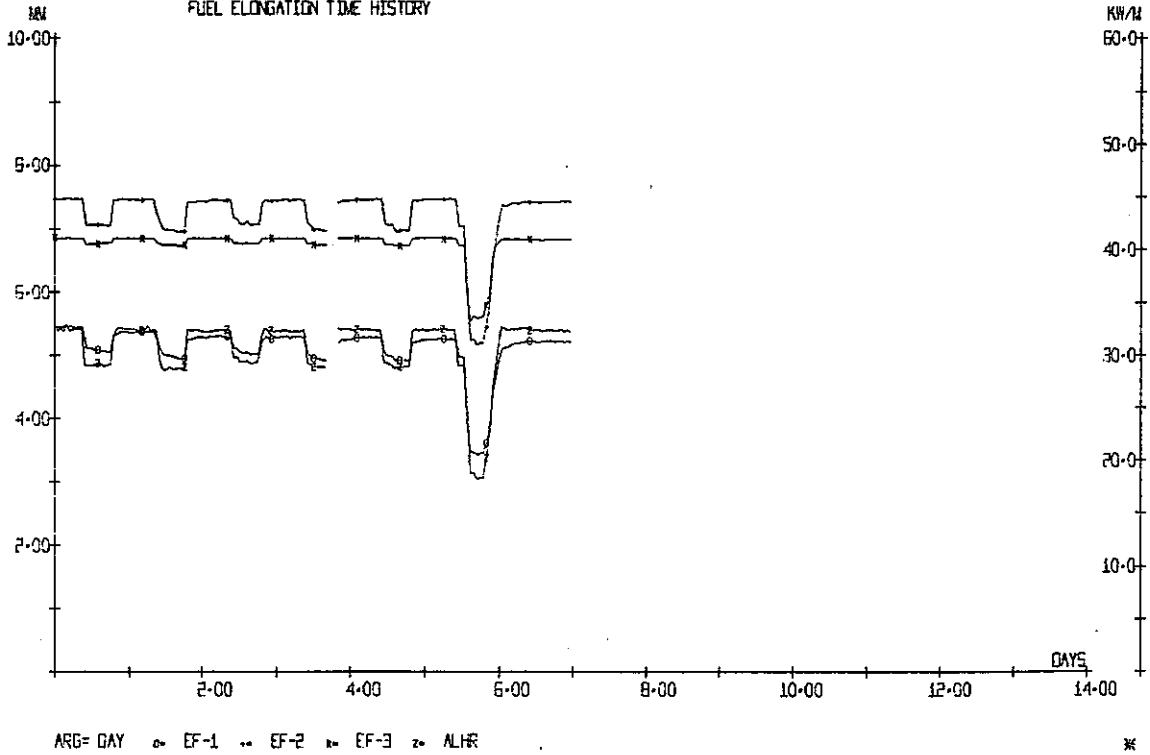

OECD HALDEN REACTOR PROJECT
 DATA FROM 1 APR 82 0 HRS TO 13 APR 82 23 HRS
 BURN-UP AT THE END OF FIRST/LAST DAY 8526 6748 MWD/T UO2

PLOT 124

IFA-529(I) PNC/JAREI JOINT EXP.
 FUEL ELONGATION TIME HISTORY

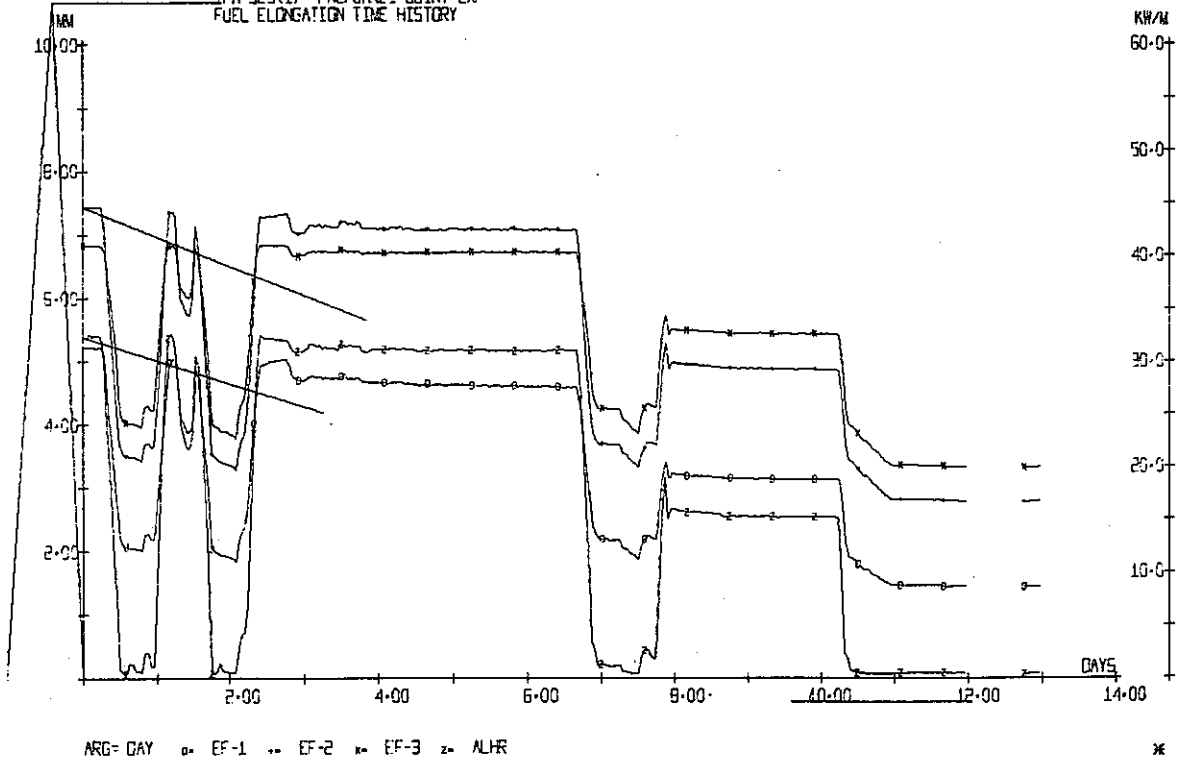

OECD HALDEN REACTOR PROJECT
 DATA FROM 19 MAY 82 0 HRS TO 1 JUNE 82 23:45 HRS
 BURN-UP AT THE END OF FIRST/LAST DAY 5213 5433 MWDT UO2

PLOT 124

IFA-529(D) PNC/JAREI JOINT EXP.
 FUEL ELONGATION TIME HISTORY

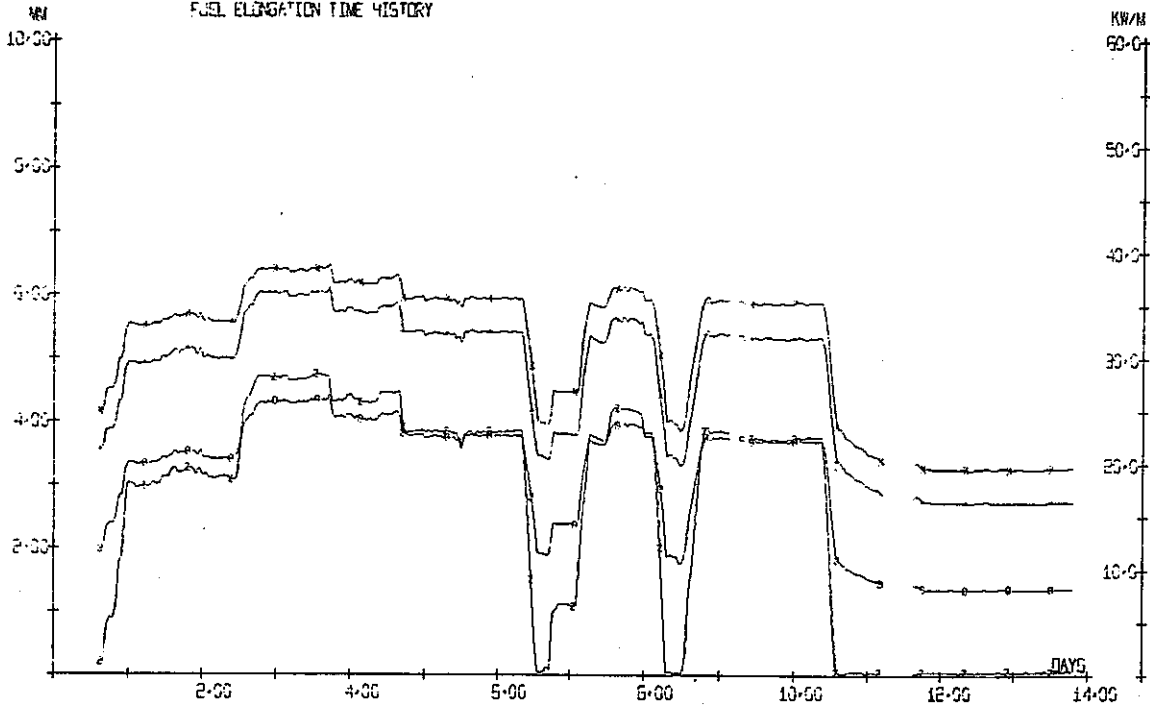

ARG= DAY ○ EF-1 □ EF-2 △ EF-3 × ALHR

*

OECD HALDEN REACTOR PROJECT
 DATA FROM 15 JUNE 82 0 HRS TO 27 JUNE 82 23:45 HRS
 BURN-UP AT THE END OF FIRST/LAST DAY 8512 8738 MWDT UO2

PLOT 124

IFA-529(D) PNC/JAREI JOINT EXP.
 FUEL ELONGATION TIME HISTORY

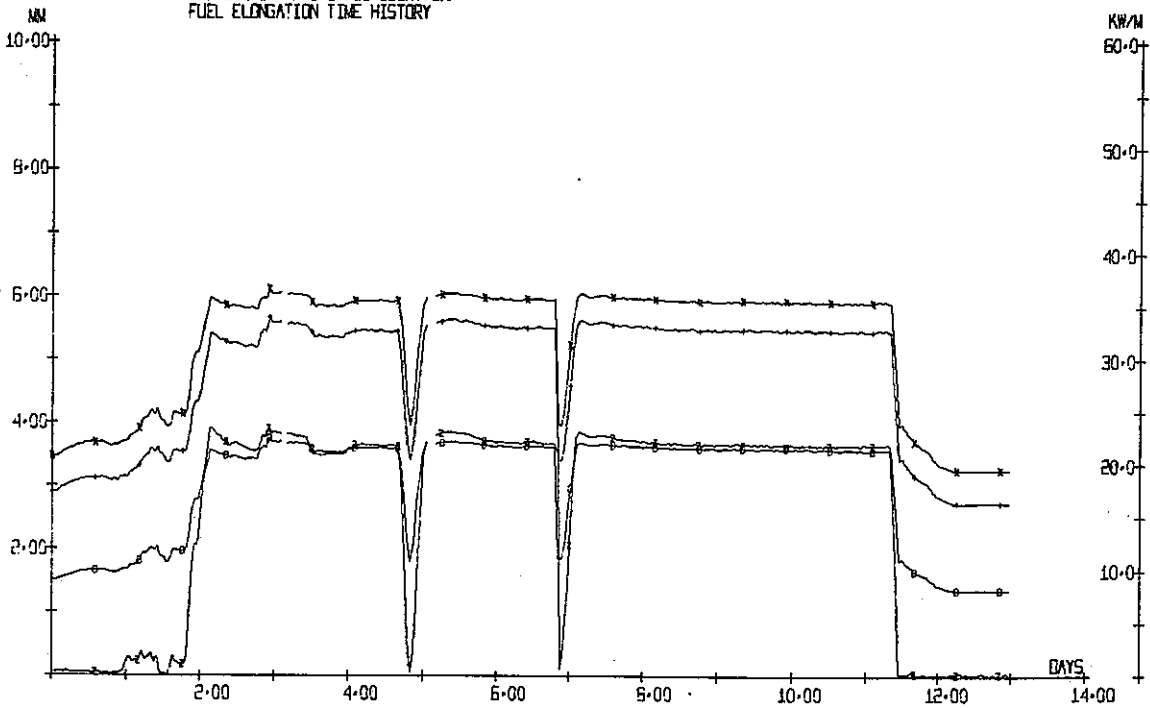

ARG= DAY ○ EF-1 □ EF-2 △ EF-3 × ALHR

*

OECD HALDEN REACTOR PROJECT
DATA FROM 1 JULY82 0 HRS TO 14 JULY82 2300 HRS
BURN-UP AT THE END OF FIRST/LAST DAY 5739 8664 MWDT UO2

PLOT 124

IFA-529(D) PNC/JAREI JOINT EXP.
FUEL ELONGATION TIME HISTORY

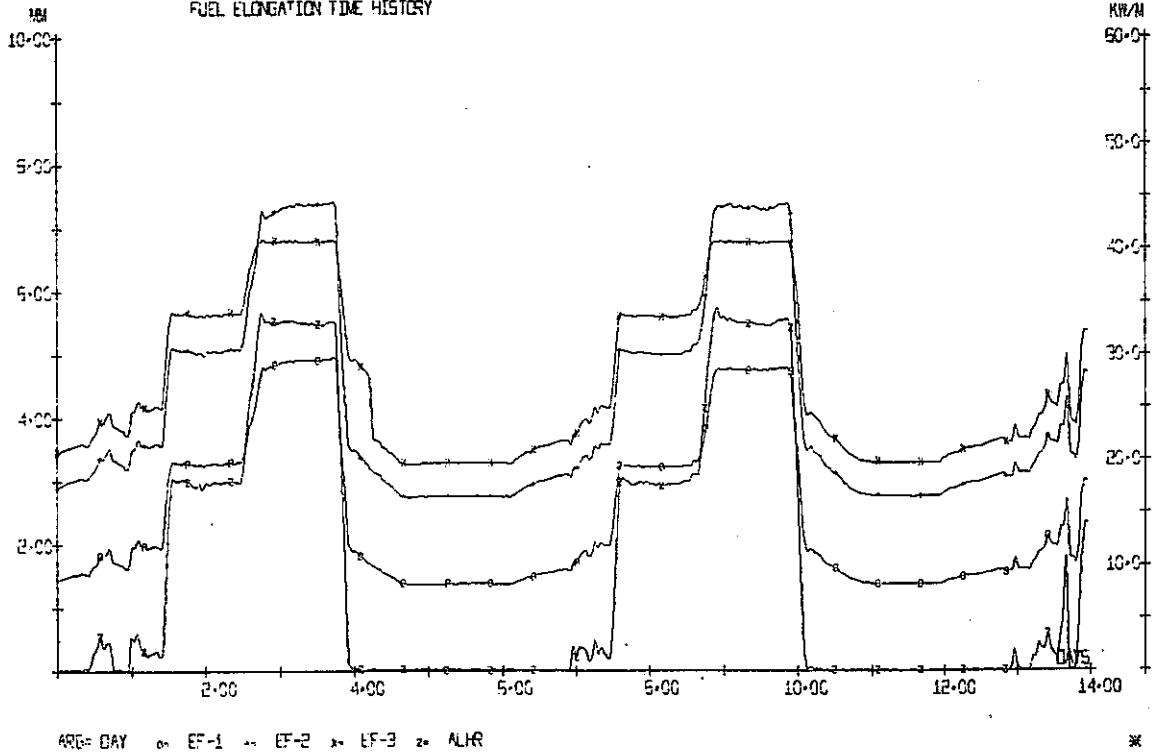

OECD HALDEN REACTOR PROJECT
DATA FROM 15 JULY82 0 HRS TO 28 JULY82 2300 HRS
BURN-UP AT THE END OF FIRST/LAST DAY 8903 9109 MWDT UO2

PLOT 124

IFA-529(D) PNC/JAREI JOINT EXP.
FUEL ELONGATION TIME HISTORY

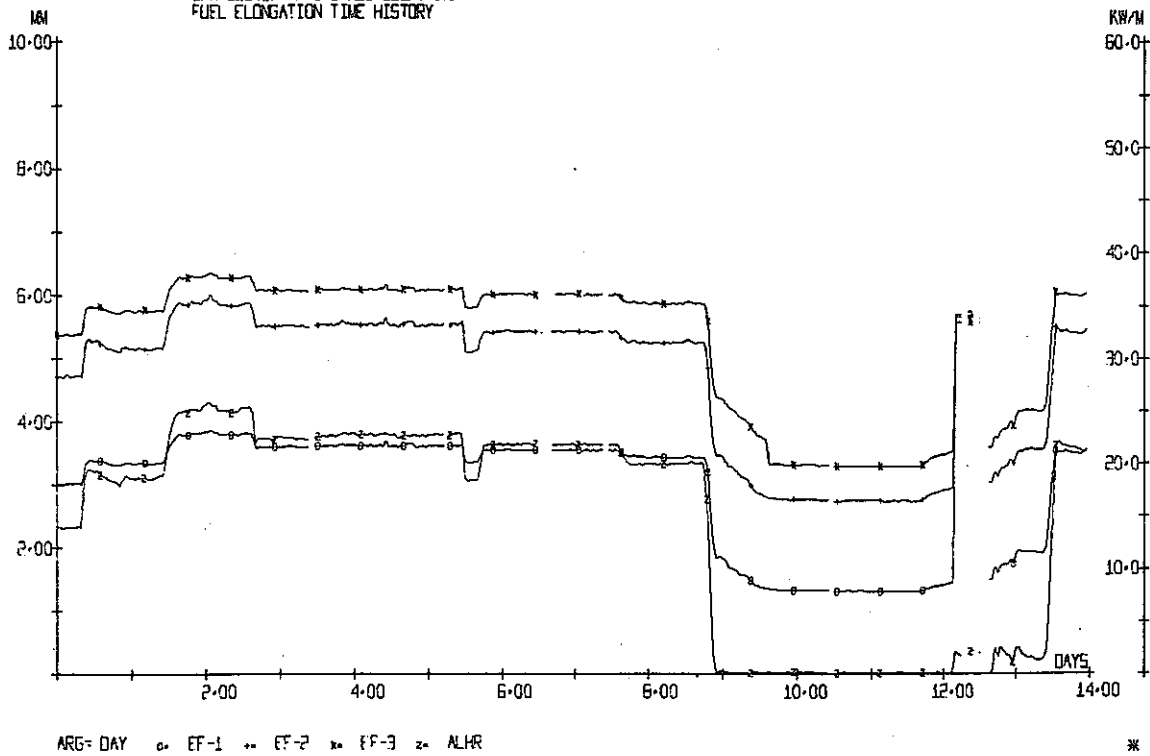

OECD HALDEN REACTOR PROJECT
 DATA FROM 29 JULY 62 0 HRS TO 7 AUG 62 2300 HRS
 BURN-UP AT THE END OF FIRST/LAST DAY 9135 9152 MWDT UO2

PLOT 124

IFA-529(1) PNC/JAREI JOINT EXP.
 FUEL ELONGATION TIME HISTORY

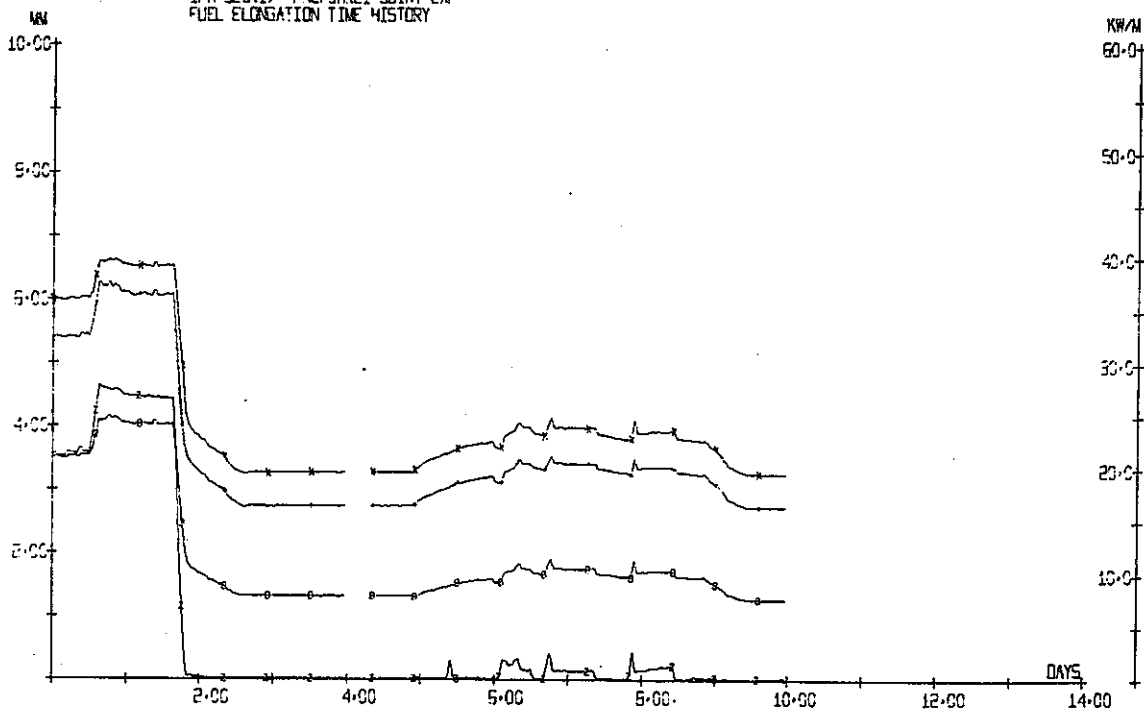

ARG= DAY o EF-1 x EF-2 * EF-3 z ALHR

OECD HALDEN REACTOR PROJECT
 DATA FROM 12 AUG 62 0 HRS TO 24 AUG 62 2300 HRS
 BURN-UP AT THE END OF FIRST/LAST DAY 9153 9305 MWDT UO2

PLOT 124

IFA-529(1) PNC/JAREI JOINT EXP.
 FUEL ELONGATION TIME HISTORY

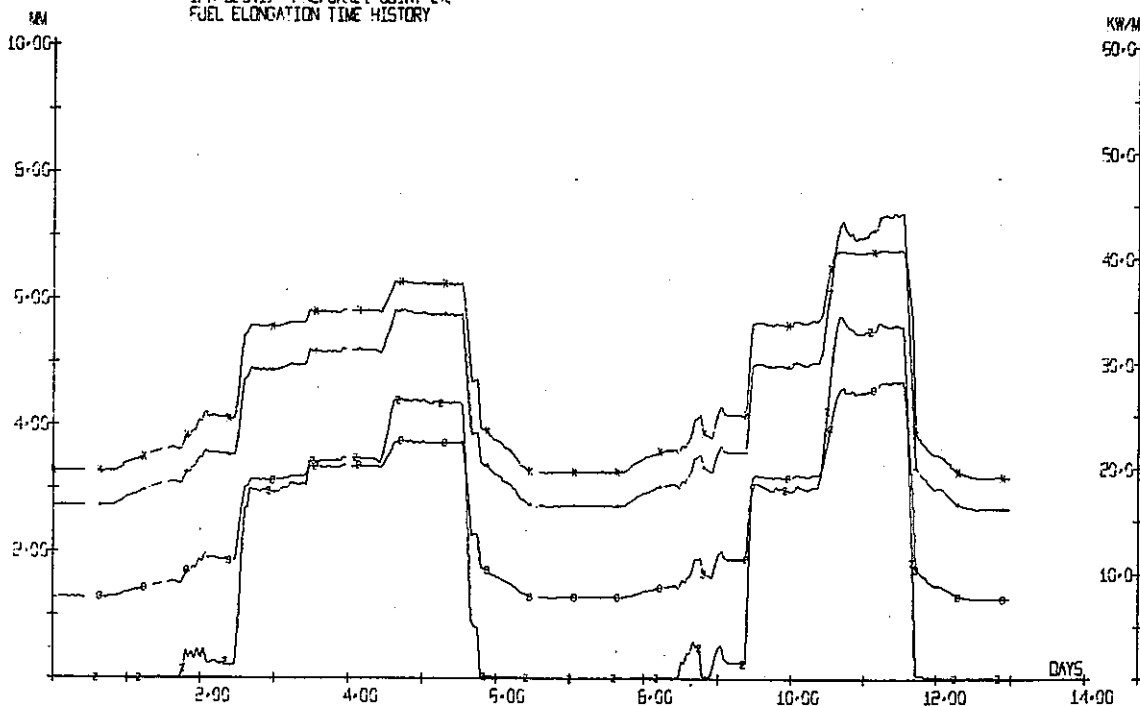

ARG= DAY o EF-1 x EF-2 * EF-3 z ALHR

OECD HALDEN REACTOR PROJECT
DATA FROM 19 SEPT 82 0 HRS TO 30 SEPT 82 2300 HRS
BURN-UP AT THE END OF FIRST/LAST DAY 9306 9496 MW/D UO2

PLOT 124

IFA-529(D) PNC/JAREI JOINT EXP.
FUEL ELONGATION TIME HISTORY

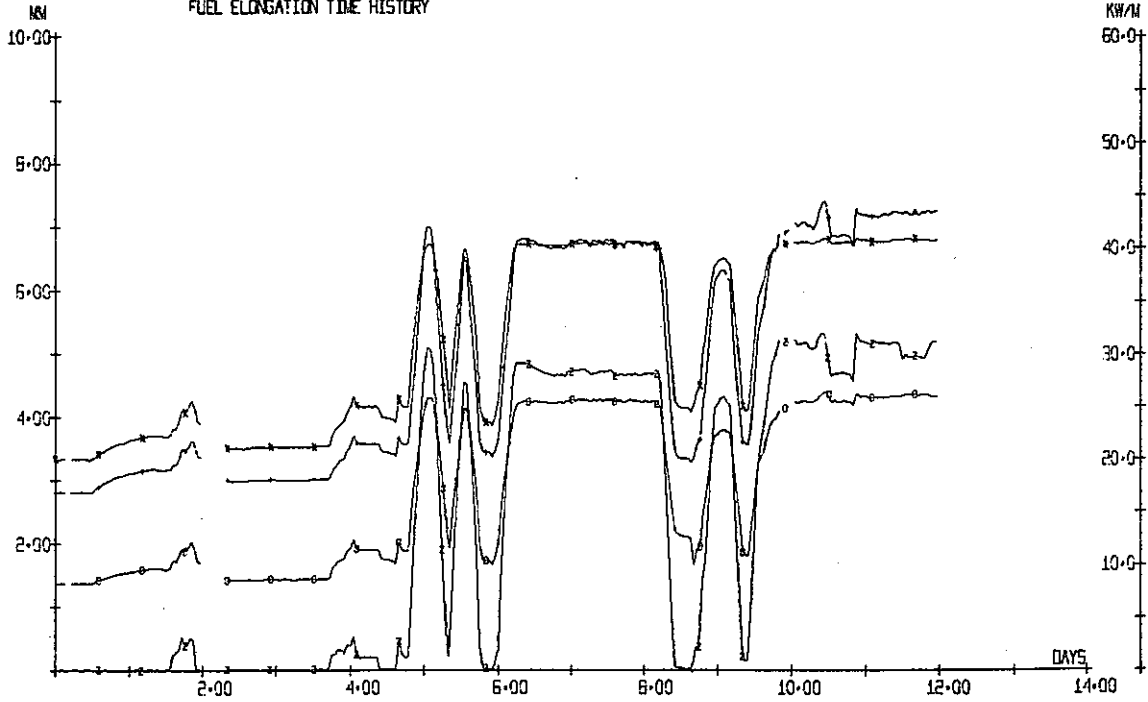

ARG= DAY o EF-1 .. EF-2 * EF-3 z ALHR

*

OECD HALDEN REACTOR PROJECT
DATA FROM 1 OCT 82 0 HRS TO 14 OCT 82 2300 HRS
BURN-UP AT THE END OF FIRST/LAST DAY 9590 9942 MW/D UO2

PLOT 124

IFA-529(D) PNC/JAREI JOINT EXP.
FUEL ELONGATION TIME HISTORY

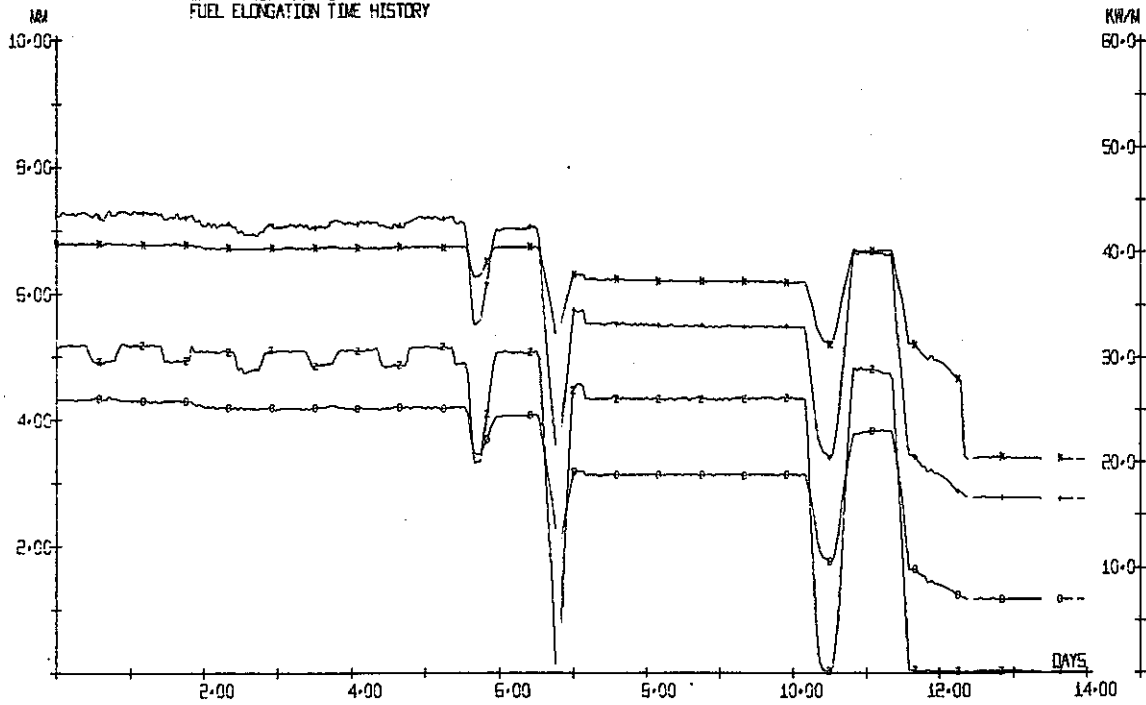

ARG= DAY o EF-1 .. EF-2 * EF-3 z ALHR

*

OECD HALDEN REACTOR PROJECT
 DATA FROM 15 OCT 82 0 HRS TO 25 OCT 82 2300 HRS
 BURN-UP AT THE END OF FIRST/LAST DAY 3942 10013 MWDT UO2

PLOT 124

IFA-523(0) PNC/JAREE JOINT EXP
 FUEL ELONGATION TIME HISTORY

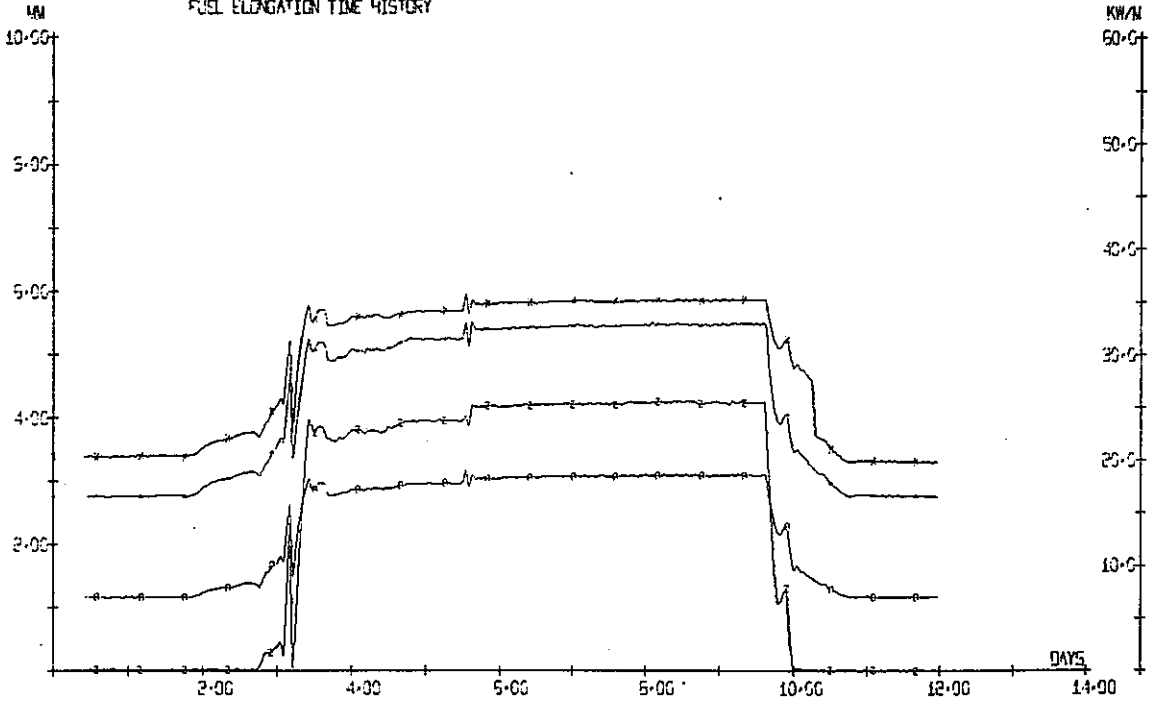

400= DAY ▽ EF-1 ▴ EF-2 * EF-3 ◻ ALH

*

OECD HALDEN REACTOR PROJECT
 DATA FROM 5 NOV 82 0 HRS TO 20 NOV 82 2300 HRS
 BURN-UP AT THE END OF FIRST/LAST DAY 10013 10276 MWDT UO2

PLOT 124

IFA-523(0) PNC/JAREE JOINT EXP
 FUEL ELONGATION TIME HISTORY

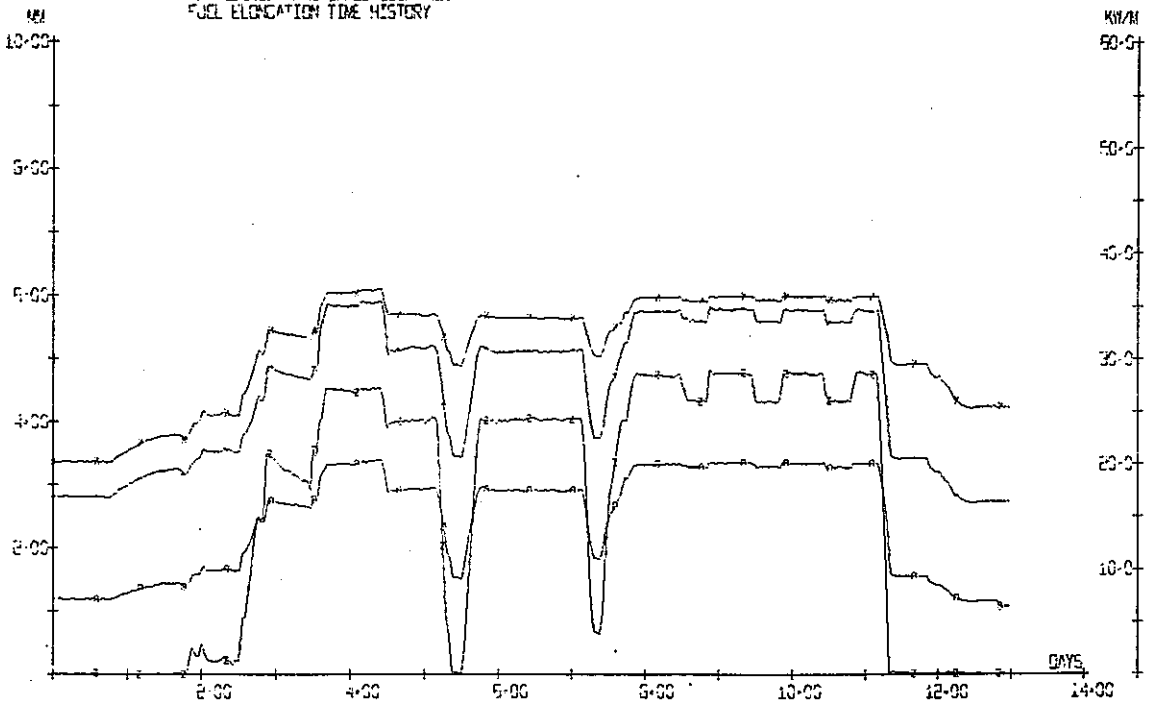

400= DAY ▽ EF-1 ▴ EF-2 * EF-3 ◻ ALH

*

OECD HALDEN REACTOR PROJECT
DATA FROM 24 NOV 62 0 HRS TO 1 DEC 62 2300 HRS
BURN-UP AT THE END OF FIRST/LAST DAY 10246 - 10576 MWDT UOZ

PLOT 124

IFA-529(D) PNC/JAREI JOINT EXP.
FUEL ELONGATION TIME HISTORY

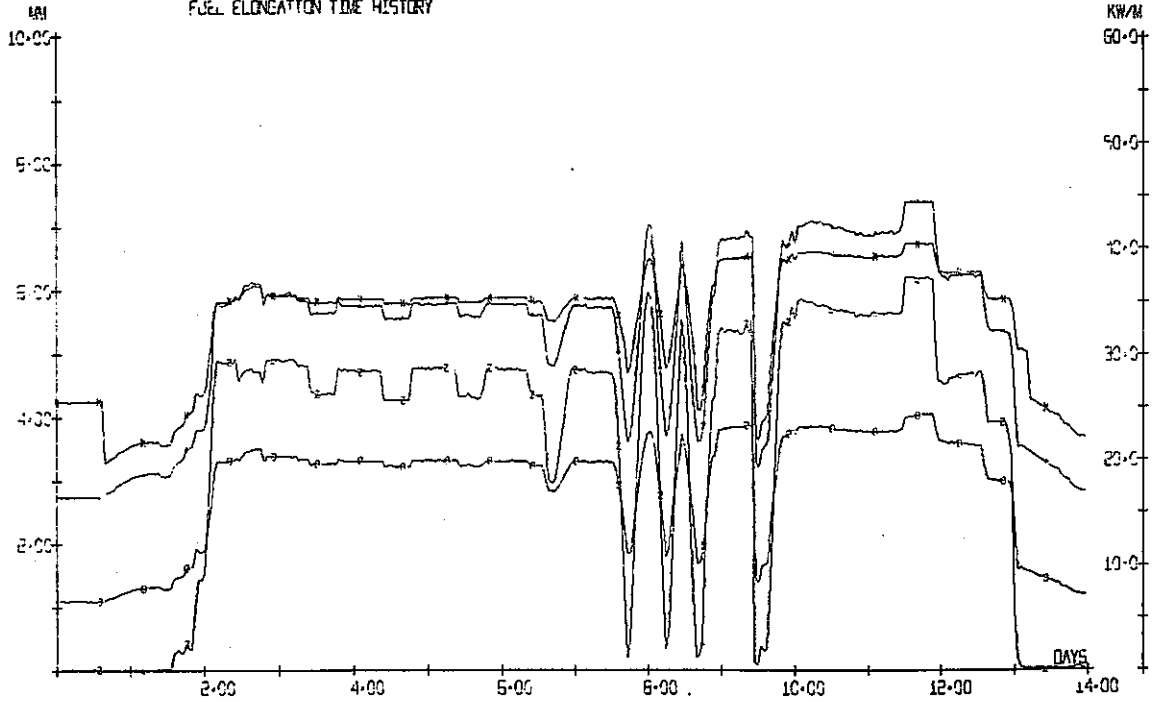

ARG= DAY @ EF-1 @ EF-2 @ EF-3 @ ALHR

*

OECD HALDEN REACTOR PROJECT
DATA FROM 16 DEC 62 0 HRS TO 31 DEC 62 2300 HRS
BURN-UP AT THE END OF FIRST/LAST DAY 10581 - 10917 MWDT UOZ

PLOT 124

IFA-529(D) PNC/JAREI JOINT EXP.
FUEL ELONGATION TIME HISTORY

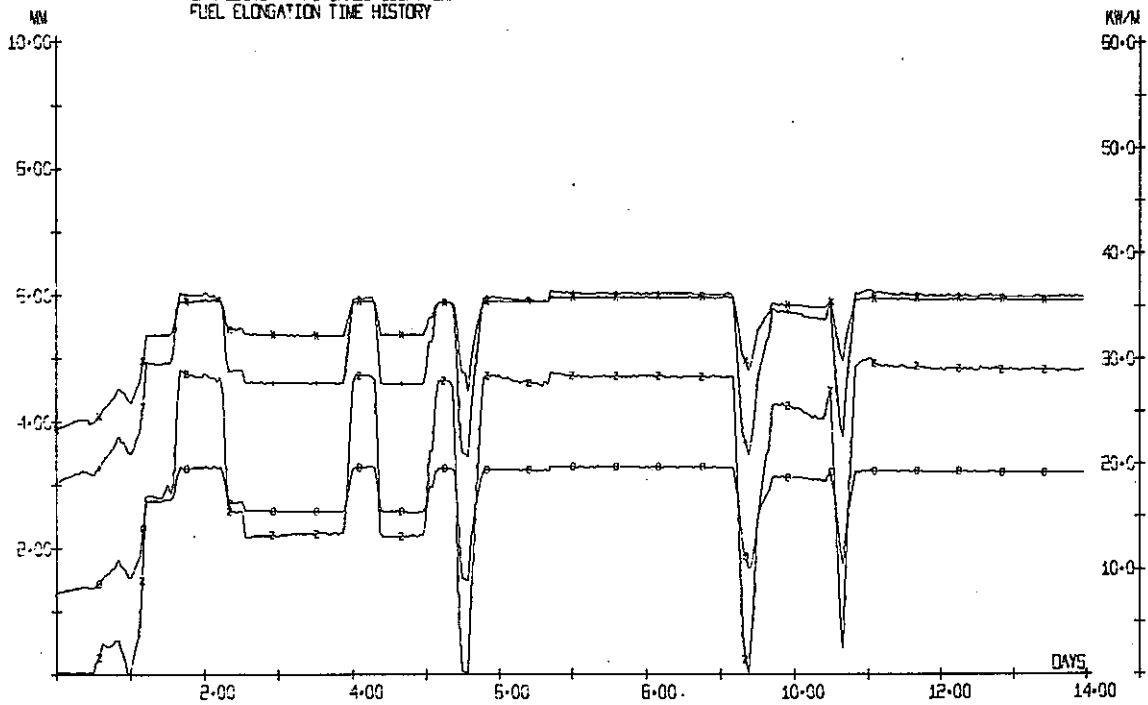

ARG= DAY @ EF-1 @ EF-2 @ EF-3 @ ALHR

*

付 録 7

I F A - 529 計 装 デ ー タ

～ T F (燃 料 中 心 温 度) デ ー タ ～

ロッド8, ロッド12

OECD HALDEN REACTOR PROJECT

DATA FROM 1 JULY80 0 HRS TO 14 JULY80 23:45 HRS
 BURN-UP AT THE END OF FIRST/LAST DAY 7. 339. MRD/T UO2

PLOT 125

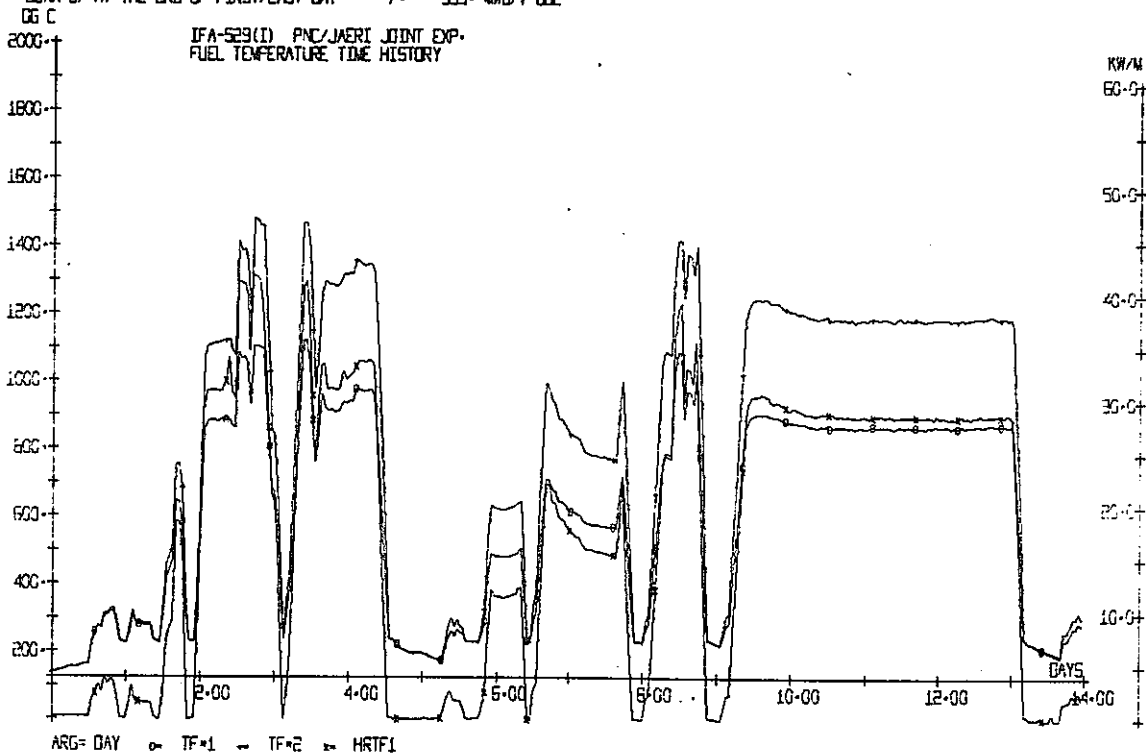

OECD HALDEN REACTOR PROJECT

DATA FROM 15 JULY80 0 HRS TO 26 JULY80 23:45 HRS
 BURN-UP AT THE END OF FIRST/LAST DAY 376. 707. MRD/T UO2

PLOT 125

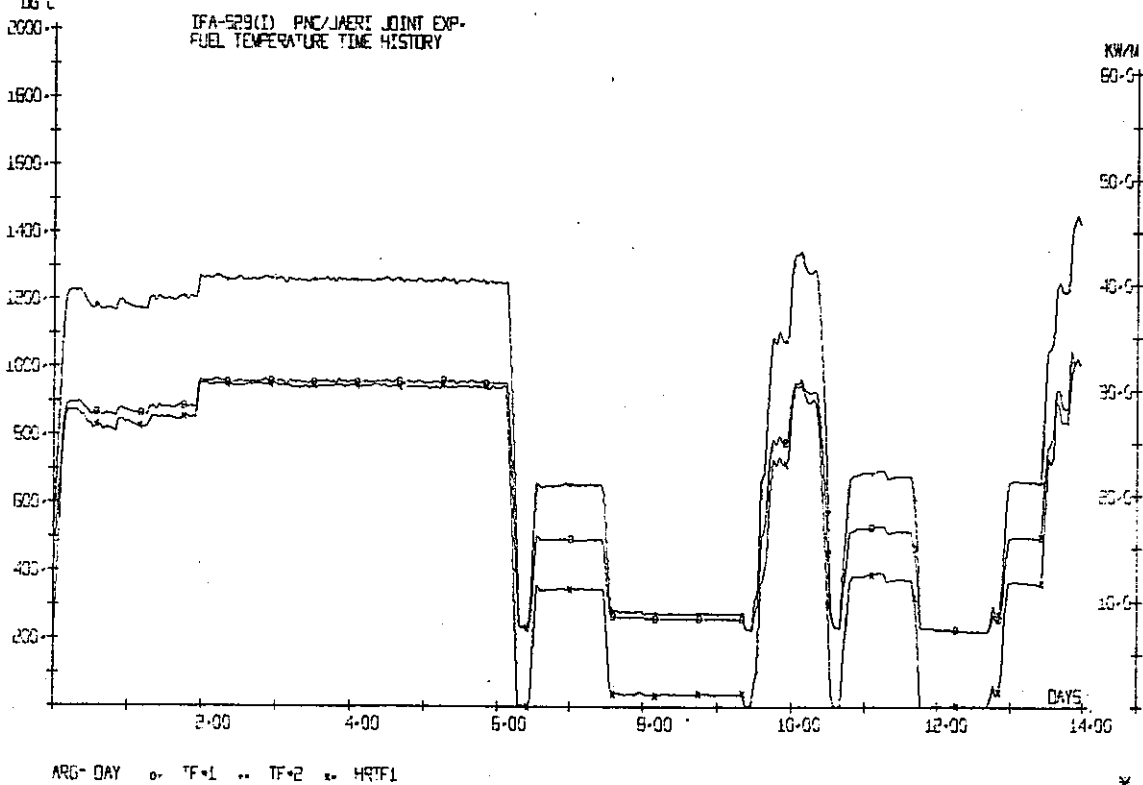

OECD HALDEN REACTOR PROJECT
 DATA FROM 29 JULY 80 0 HRS TO 11 AUG 80 23:45 HRS
 BURN-UP AT THE END OF FIRST/LAST DAY 735- 1131 MWD/T UO2

PLOT 125

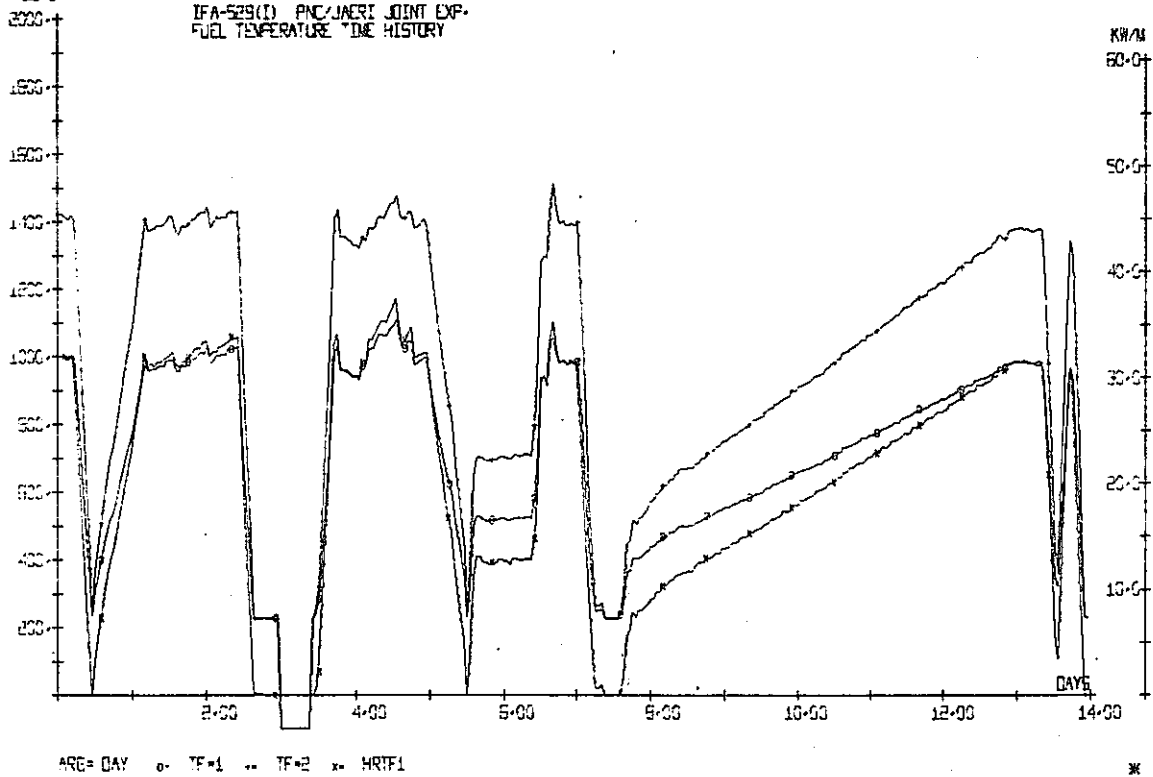

OECD HALDEN REACTOR PROJECT
 DATA FROM 12 AUG 80 0 HRS TO 17 AUG 80 23:45 HRS
 BURN-UP AT THE END OF FIRST/LAST DAY 1173- 1291 MWD/T UO2

PLOT 126

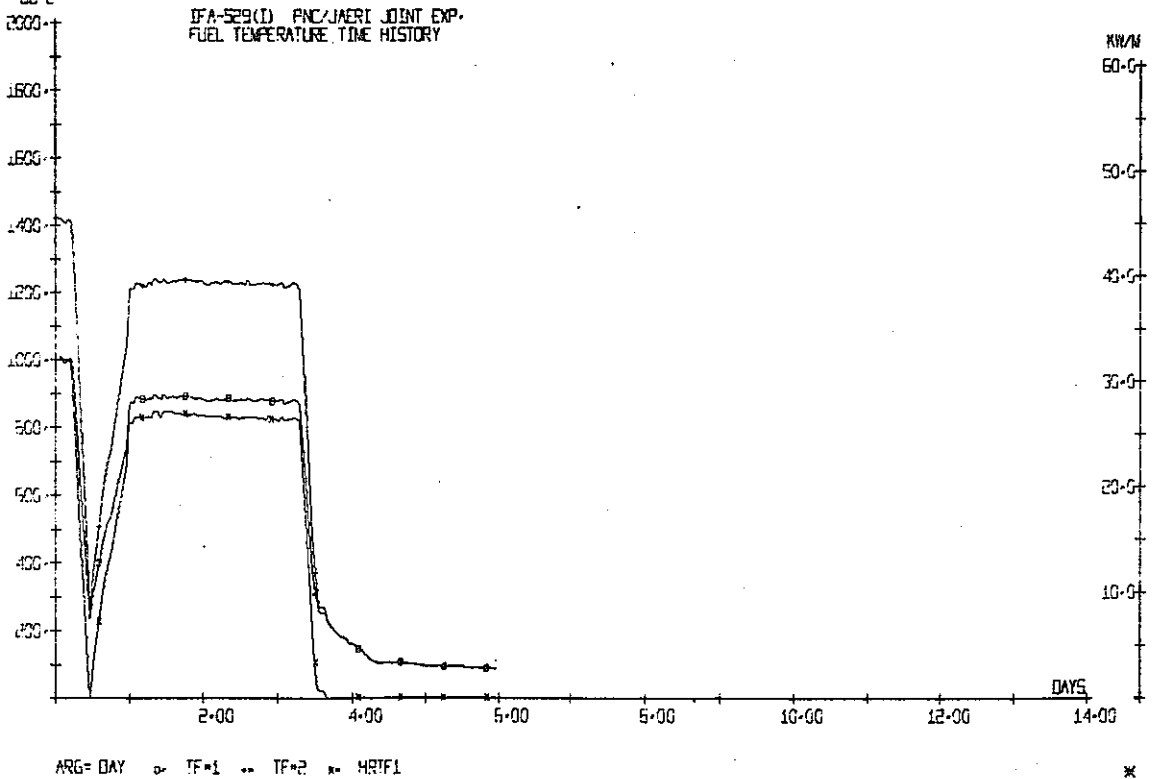

OEDD HALDEN REACTOR PROJECT

DATA FROM 10 SEPT80 0 HRS TO 23 SEPT80 23:45 HRS
 BURN-UP AT THE END OF FIRST/LAST DAY 95.1 1272 MW/D/T UO2

PLOT 125

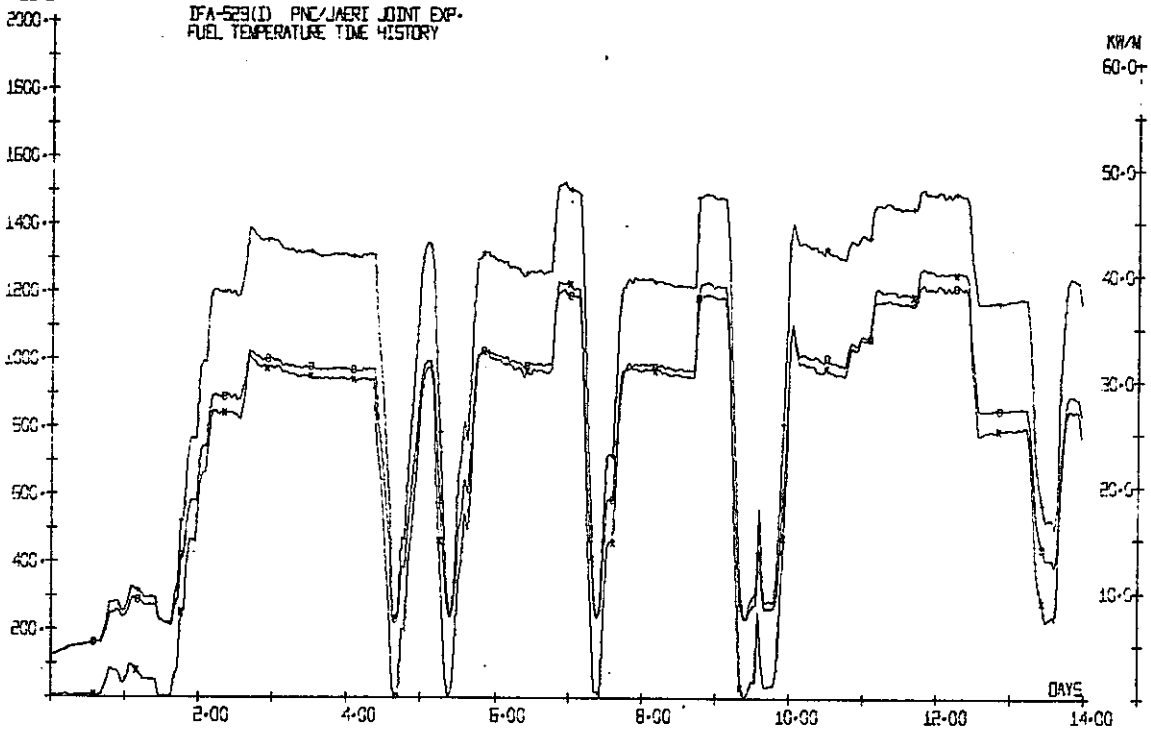

OEDD HALDEN REACTOR PROJECT

DATA FROM 24 SEPT80 0 HRS TO 30 SEPT80 23:45 HRS
 BURN-UP AT THE END OF FIRST/LAST DAY 1284 1411 MW/D/T UO2

PLOT 126

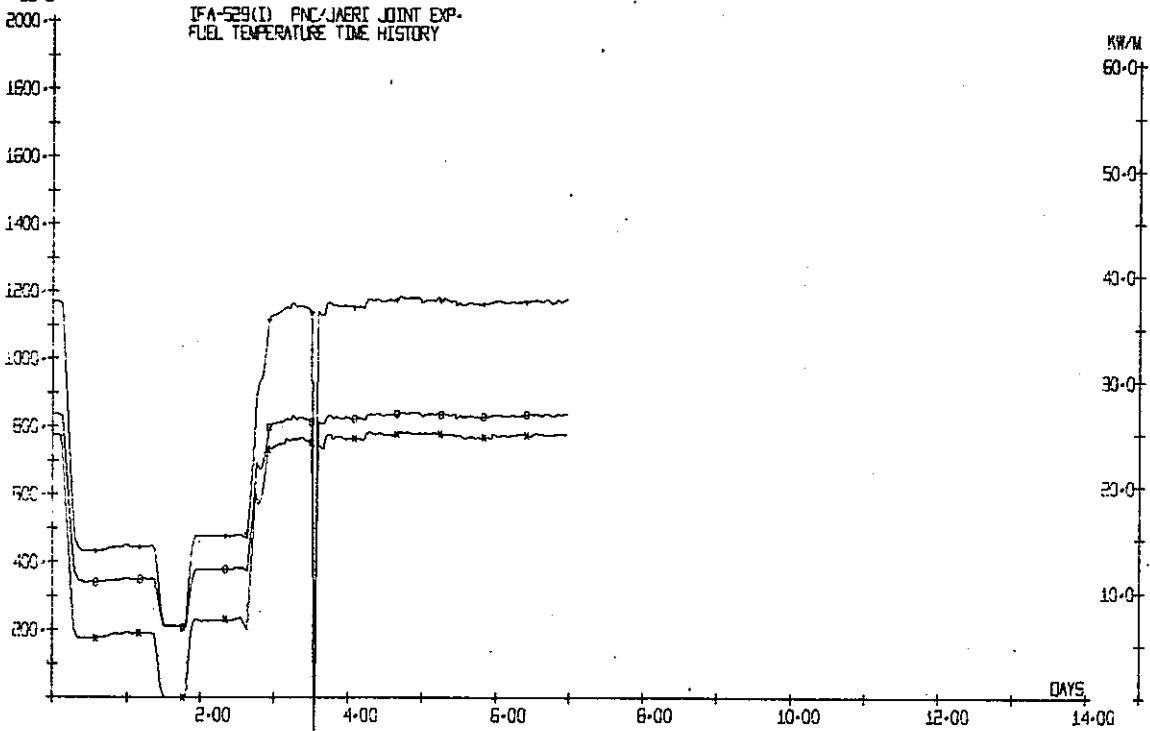

OECD HALDEN REACTOR PROJECT

DATA FROM 1 OCT 80 0 HRS TO 5 OCT 80 23:45 HRS
 BURN-UP AT THE END OF FIRST/LAST DAY 1430 - 1478 MW/D/UC2

PLOT 125

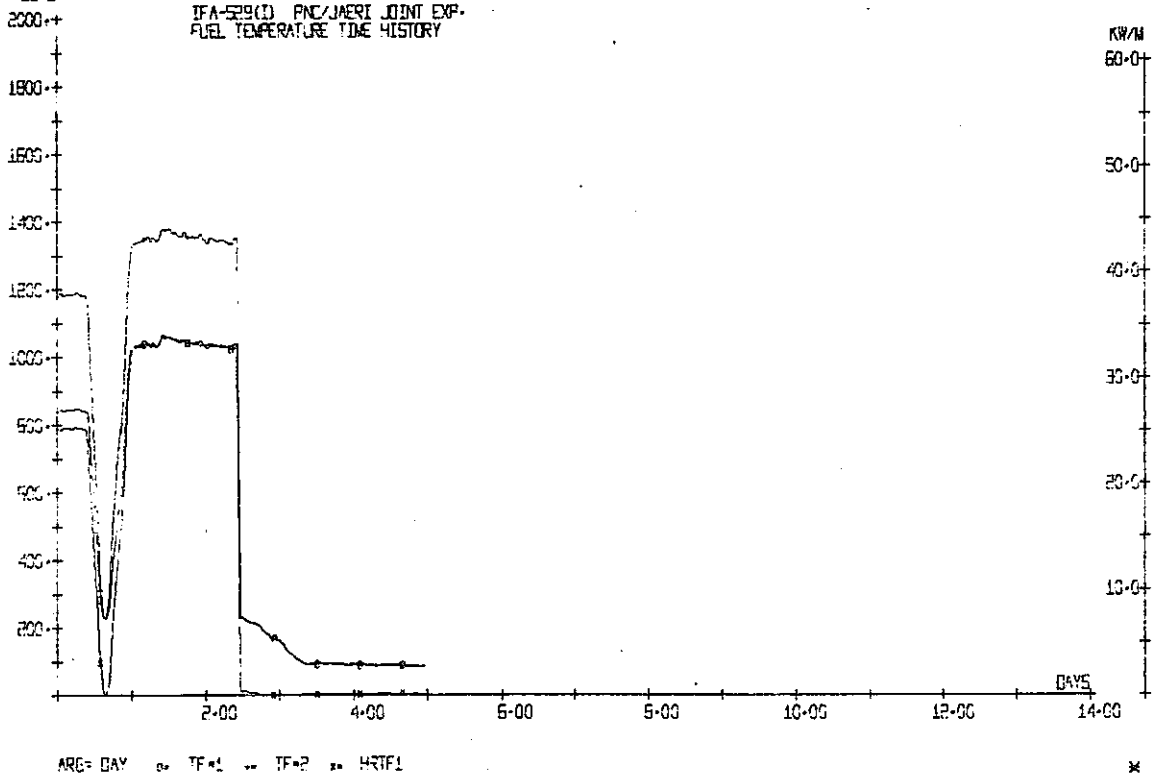

OECD HALDEN REACTOR PROJECT

DATA FROM 12 DEC 80 0 HRS TO 23 DEC 80 1800 HRS
 BURN-UP AT THE END OF FIRST/LAST DAY 1481 - 1700 MW/D/UC2

PLOT 125

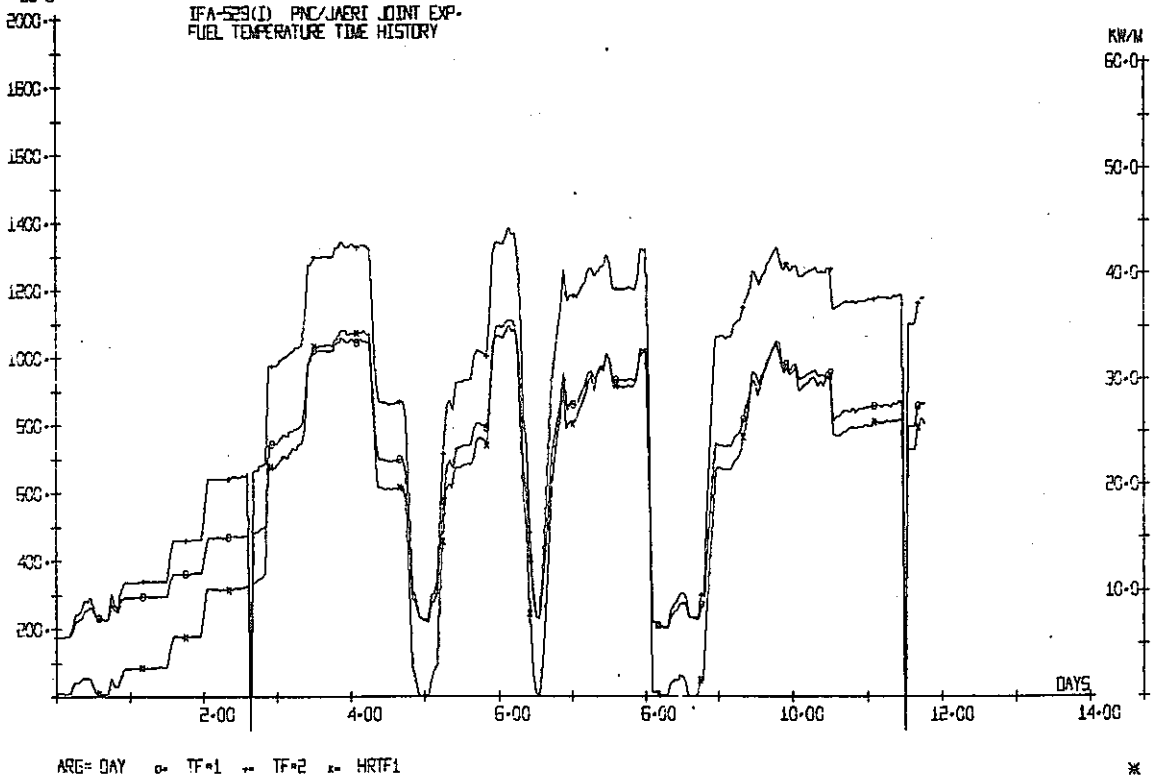

GECD HALDEN REACTOR PROJECT

PLOT 126

DATA FROM 1 JAN 81 0 HRS TO 14 JAN 81 23:45 HRS
 BURN-UP AT THE END OF FIRST/LAST DAY 1926 -99 MWDT UOZ

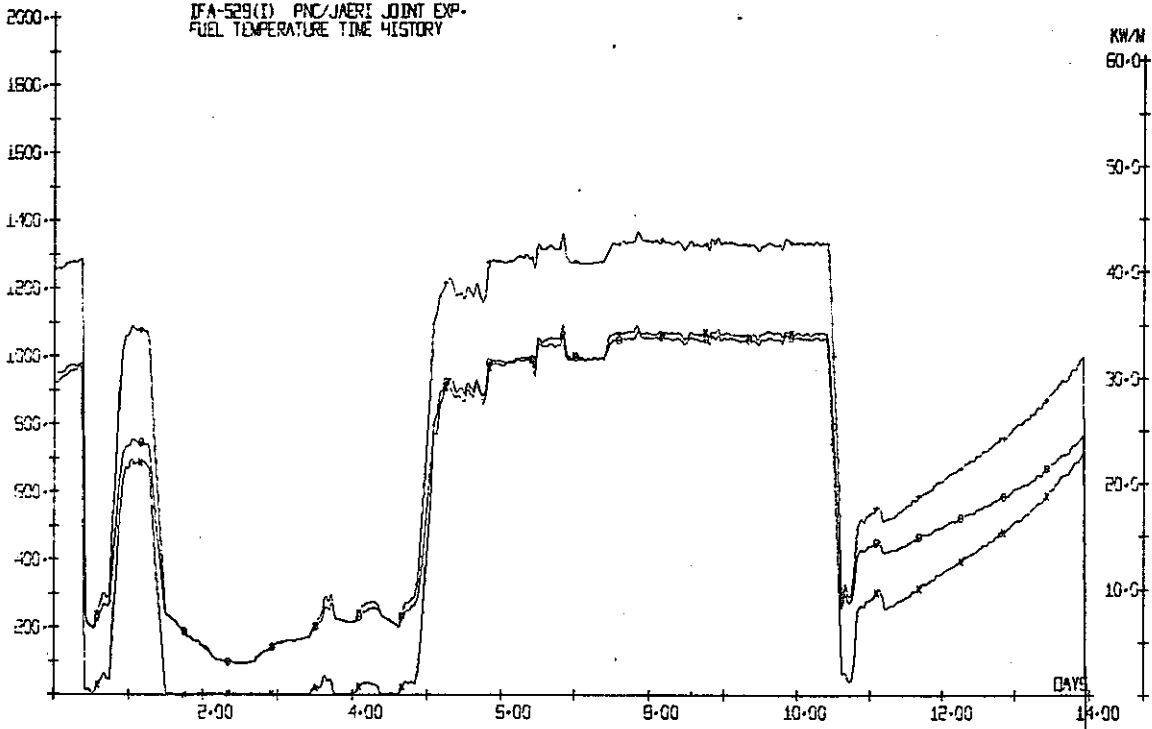

ARG= DAY @ TF=1 -- TF=2 * HRTF1

*

GECD HALDEN REACTOR PROJECT

PLOT 126

DATA FROM 15 JAN 81 0 HRS TO 19 JAN 81 23:45 HRS
 BURN-UP AT THE END OF FIRST/LAST DAY 1991 -99 MWDT UOZ

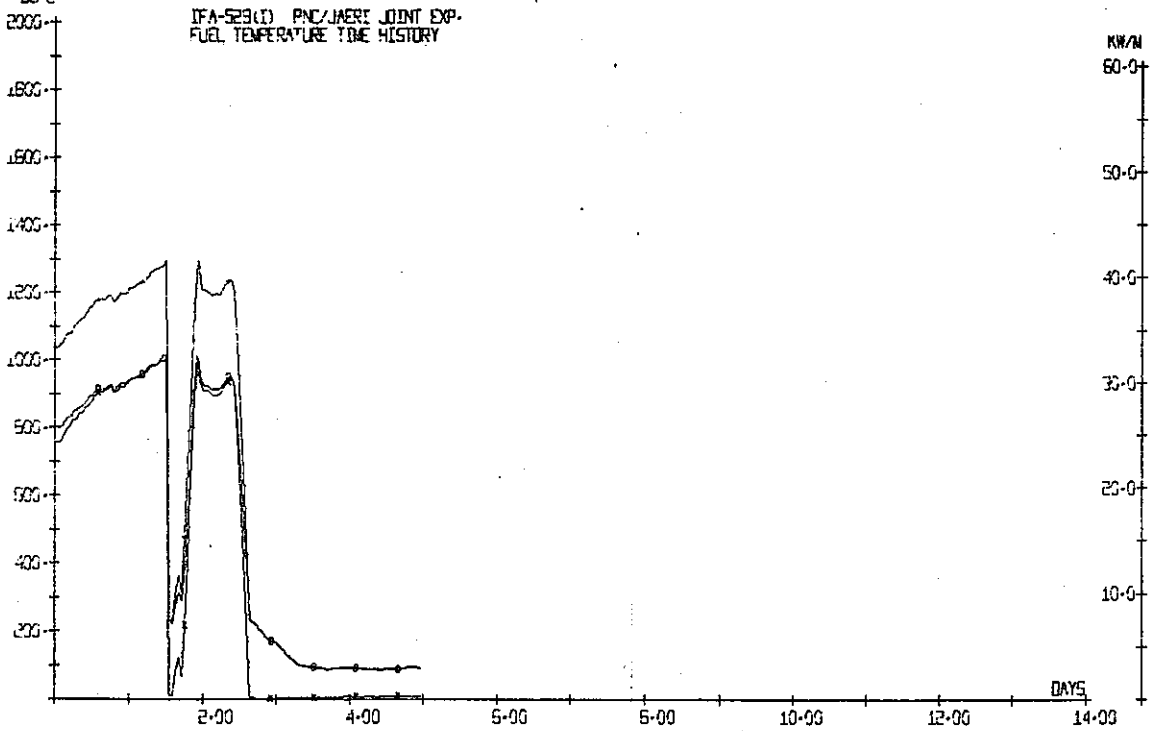

ARG= DAY @ TF=1 -- TF=2 * HRTF1

*

OECD HALDEN REACTOR PROJECT
 DATA FROM 29 JAN 81 0 HRS TO 9 FEB 81 23 HRS
 BURN-UP AT THE END OF FIRST/LAST DAY -99- 2471 MW/D UO2

PLOT 126

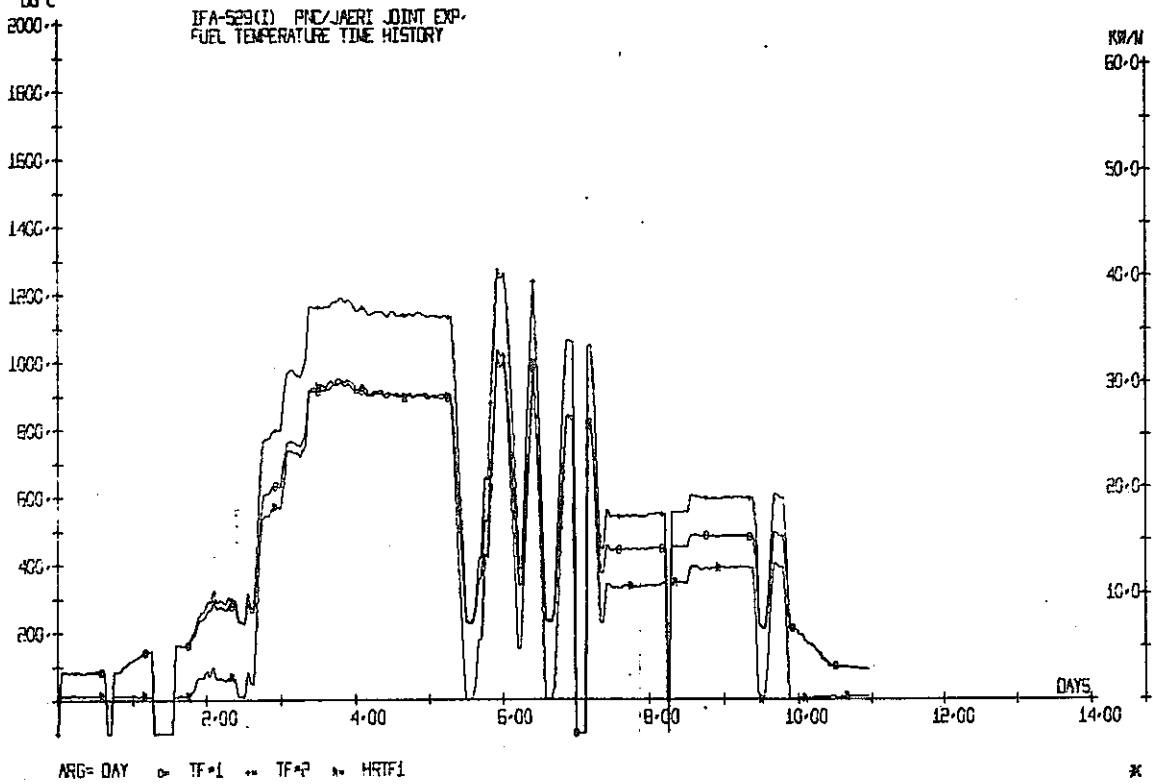

OECD HALDEN REACTOR PROJECT
 DATA FROM 1 APR 81 0 HRS TO 14 APR 81 23 HRS
 BURN-UP AT THE END OF FIRST/LAST DAY 2471 2984 MW/D UO2

PLOT 126

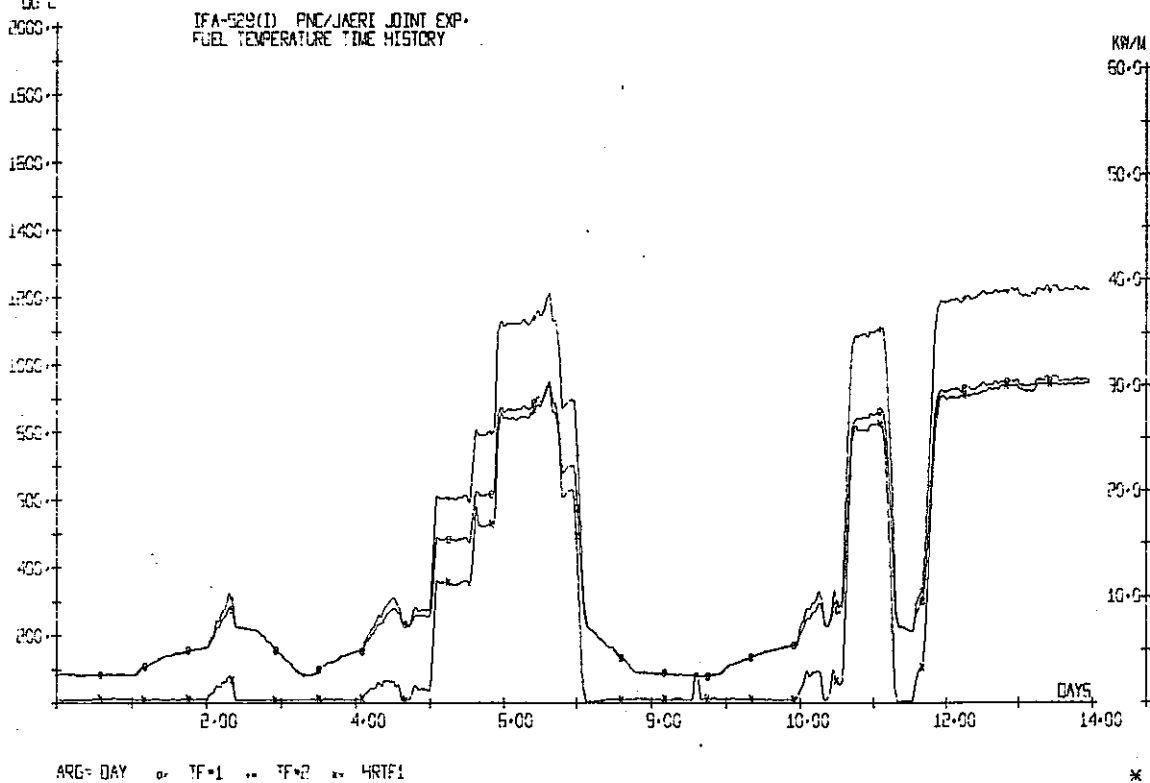

OEDD HALDEN REACTOR PROJECT

DATA FROM 15 APR 61 0 HRS TO 29 APR 61 23:45 HRS
 BURN-UP AT THE END OF FIRST/LAST DAY 2513 2321 MWDT UO2

PLOT 125

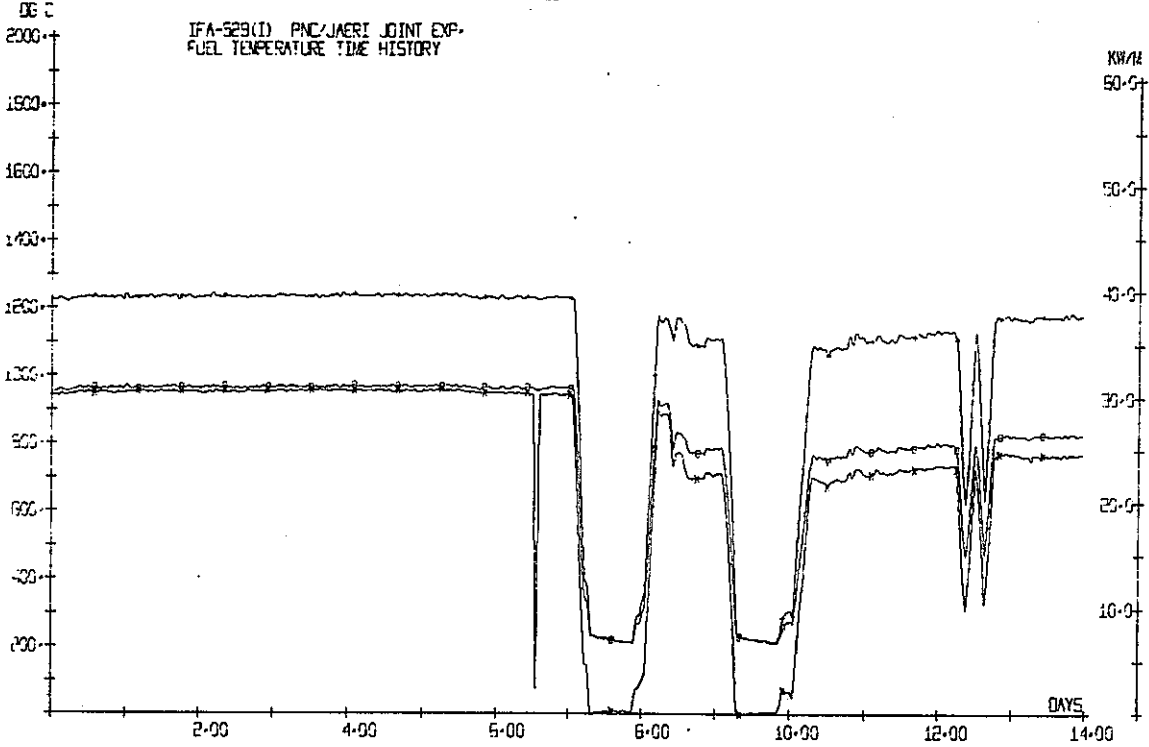

ARC= DAY o TF#1 -- TF#2 x KWTF1 *

OEDD HALDEN REACTOR PROJECT

DATA FROM 29 APR 61 0 HRS TO 12 MAY 61 23:45 HRS
 BURN-UP AT THE END OF FIRST/LAST DAY 2931 3203 MWDT UO2

PLOT 125

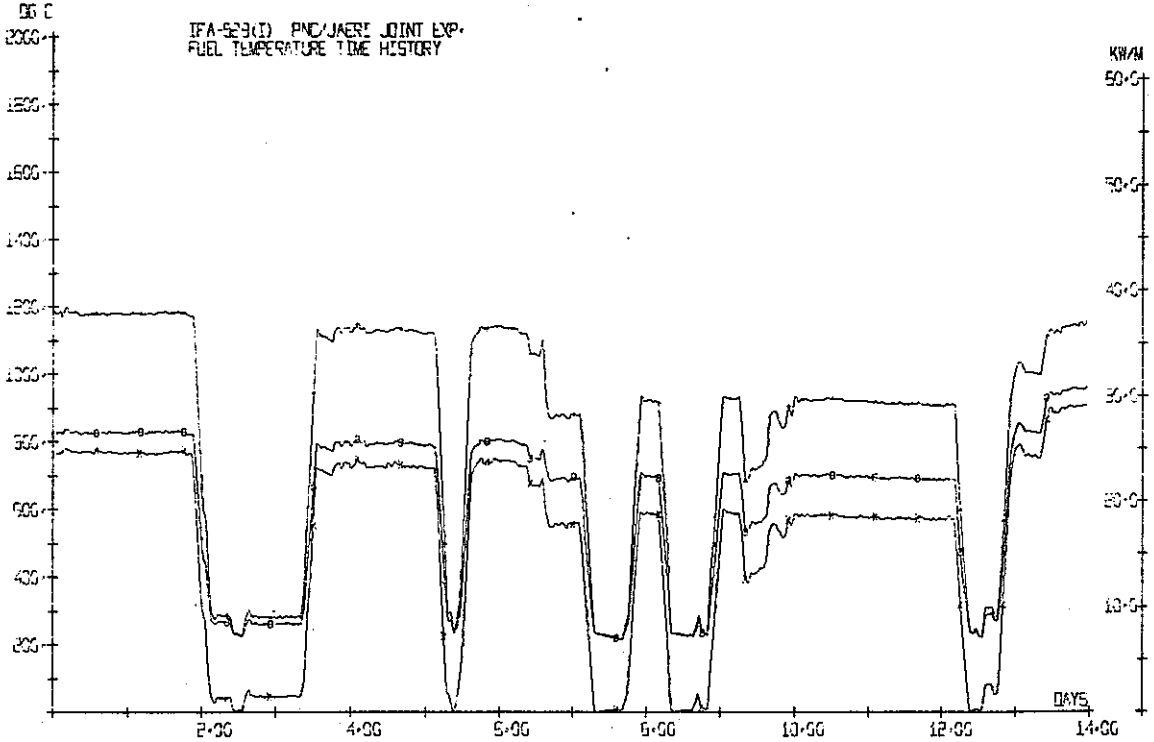

ARC= DAY o TF#1 -- TF#2 x KWTF1 *

OEDD HALDEN REACTOR PROJECT
 DATA FROM 13 MAY 81 0 HRS TO 25 MAY 81 23 HRS
 BURN-UP AT THE END OF FIRST/LAST DAY 3232 3757 MW/D UO2
 UG C

PLOT 125

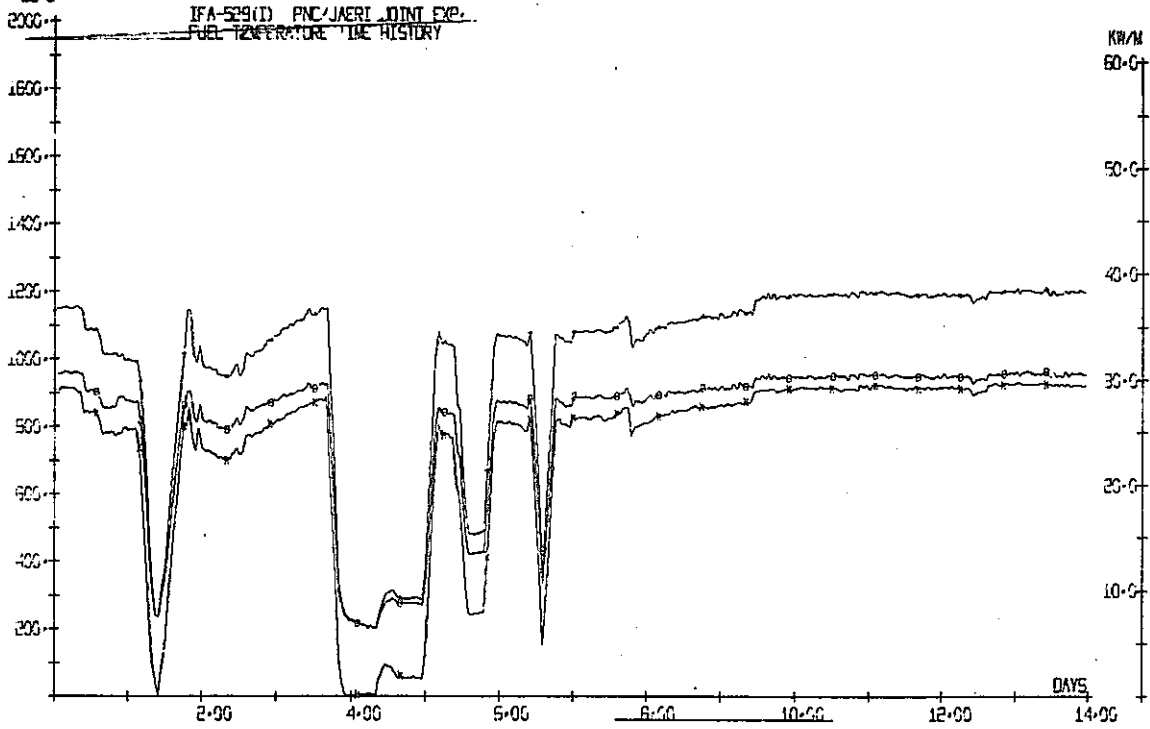

ARG= DAY o TF=1 .. TF=2 x HRTF1

*

OEDD HALDEN REACTOR PROJECT
 DATA FROM 27 MAY 81 0 HRS TO 6 JUNE 81 23 HRS
 BURN-UP AT THE END OF FIRST/LAST DAY 3587 3662 MW/D UO2
 UG C

PLOT 125

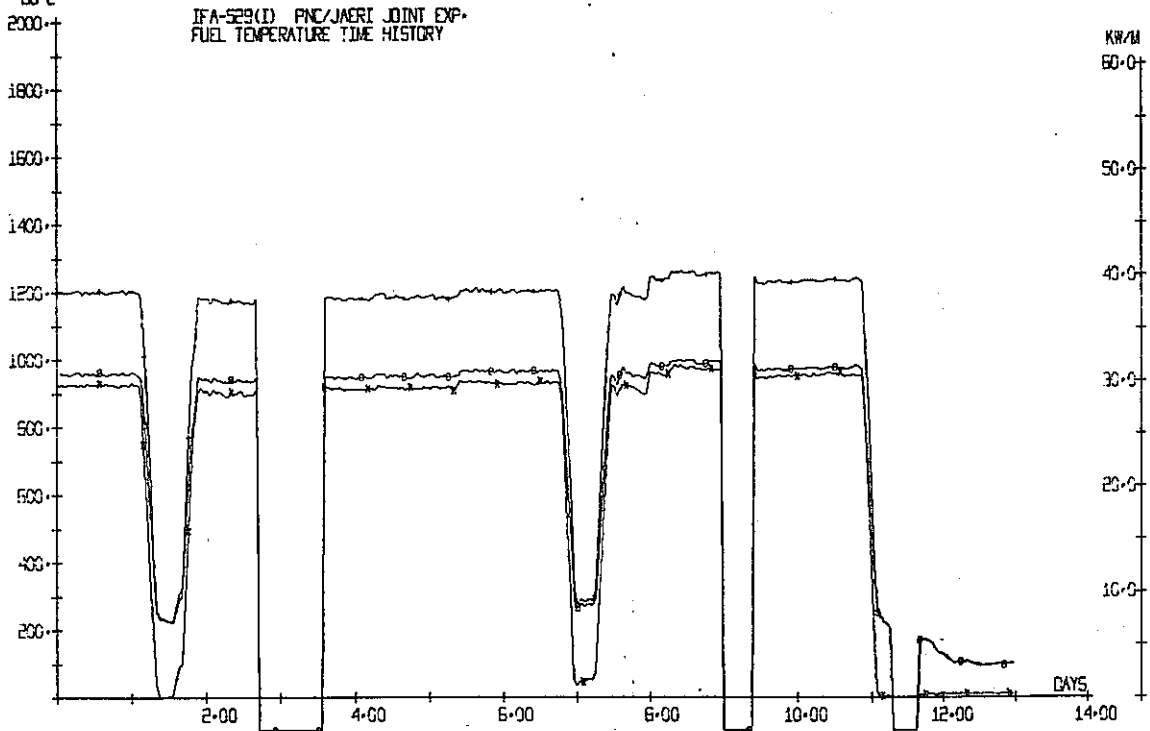

ARG= DAY o TF=1 .. TF=2 x HRTF1

*

OECD HALDEN REACTOR PROJECT

DATA FROM 20 JUNE 81 0 HRS TO 30 JUNE 81 23:45 HRS
BURN-UP AT THE END OF FIRST/LAST DAY 3862* 4061 MWDT UOE

PLOT 125

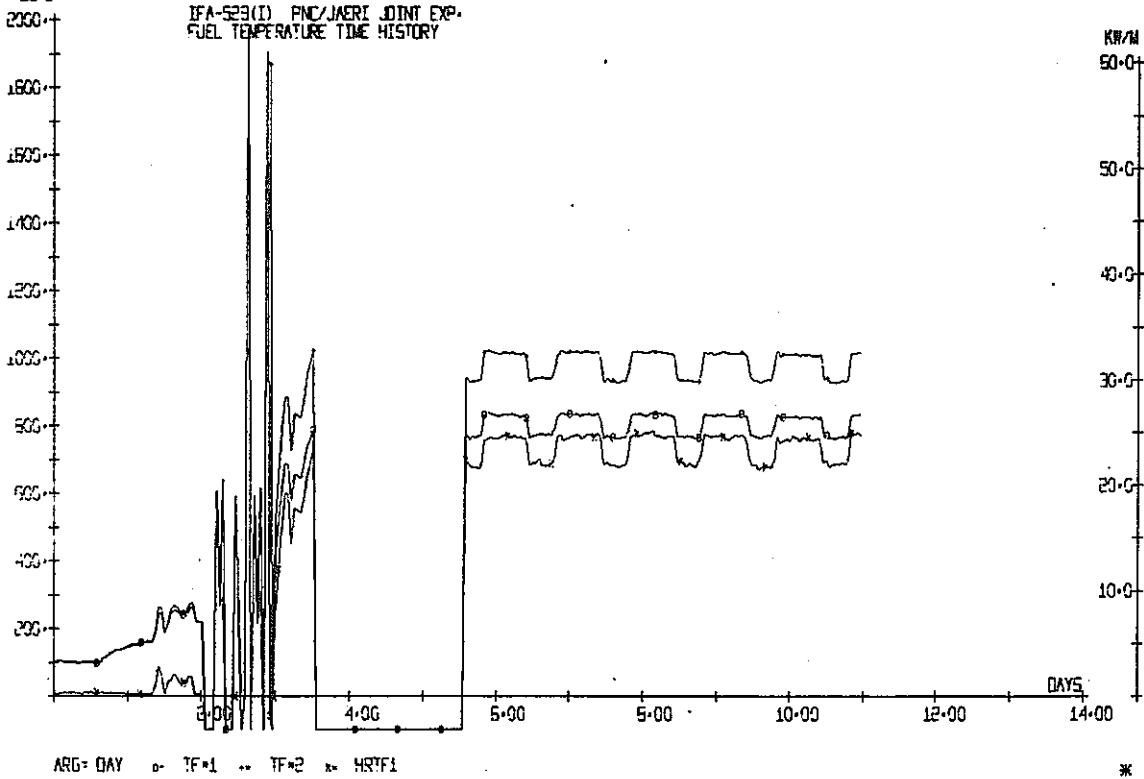

OECD HALDEN REACTOR PROJECT

DATA FROM 1 JULY 81 0 HRS TO 14 JULY 81 23:45 HRS
BURN-UP AT THE END OF FIRST/LAST DAY 4067* 4468 MWDT UOE

PLOT 126

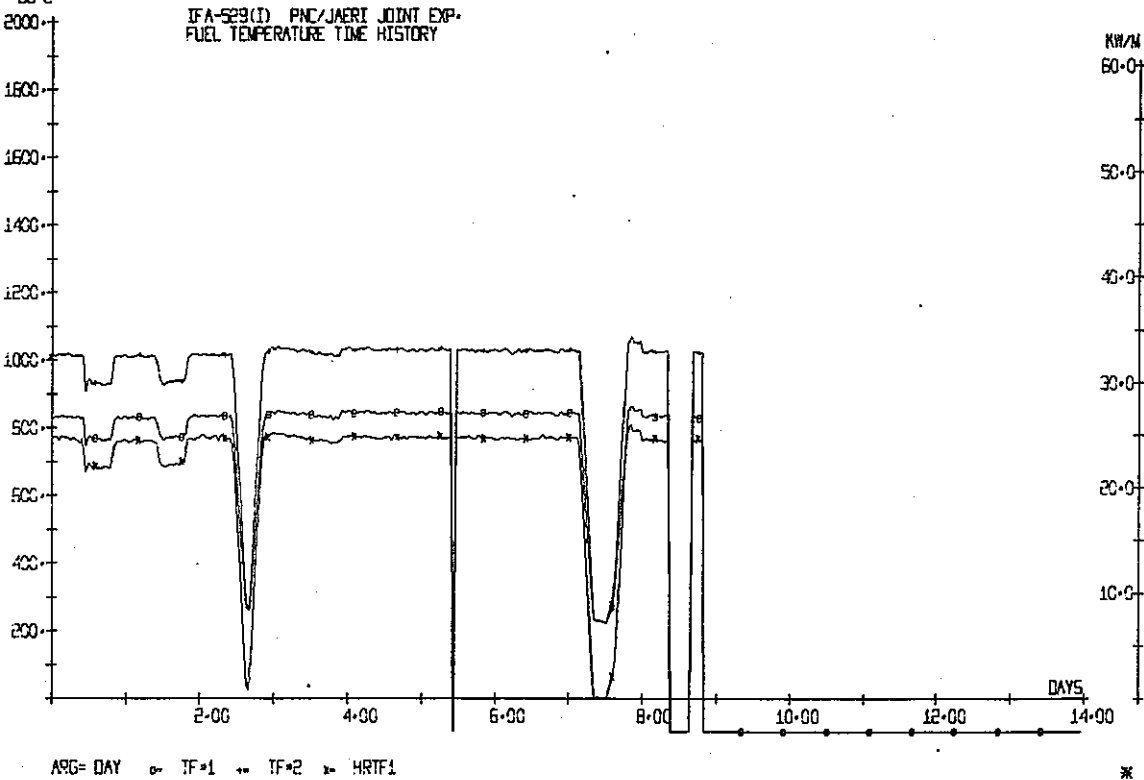

OEDD HALDEN REACTOR PROJECT

DATA FROM 15 JULY 81 0 HRS TO 25 JULY 81 23:45 HRS
 BURN-UP AT THE END OF FIRST/LAST DAY 4472 4820 MW/D/T, UO2

PLOT 125

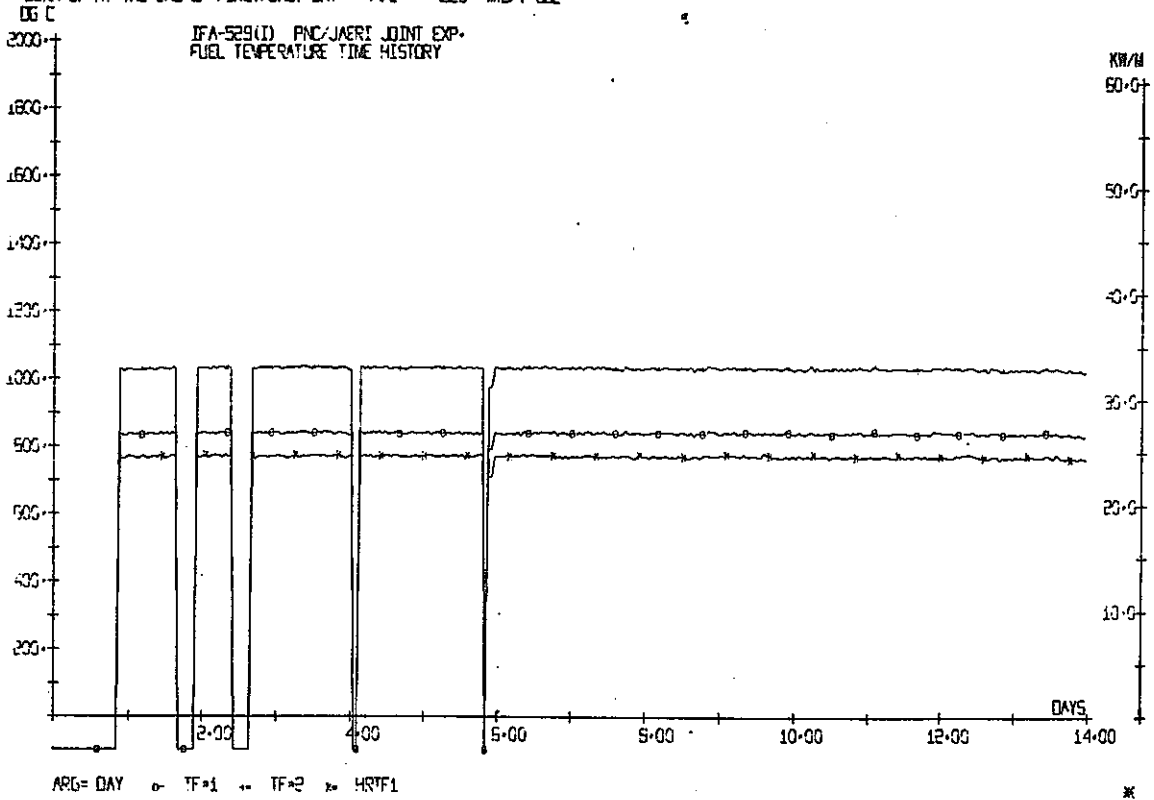

OEDD HALDEN REACTOR PROJECT

DATA FROM 29 JULY 81 0 HRS TO 11 AUG 81 23:45 HRS
 BURN-UP AT THE END OF FIRST/LAST DAY 4846 5307 MW/D/T, UO2

PLOT 125

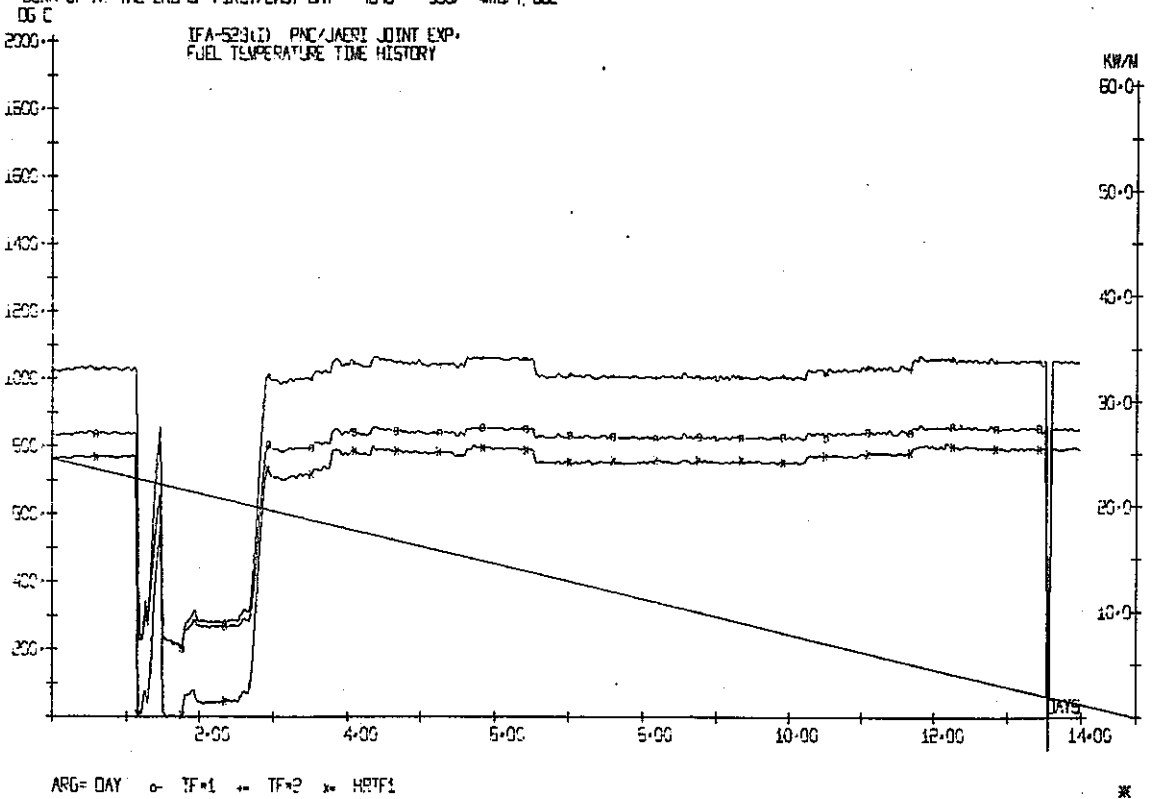

OECD HALDEN REACTOR PROJECT

DATA FROM 12 AUG 81 0 HRS TO 22 AUG 81 2345 HRS
 BURN-UP AT THE END OF FIRST/LAST DAY 5335 5576 MWDT UO2

PLOT 126

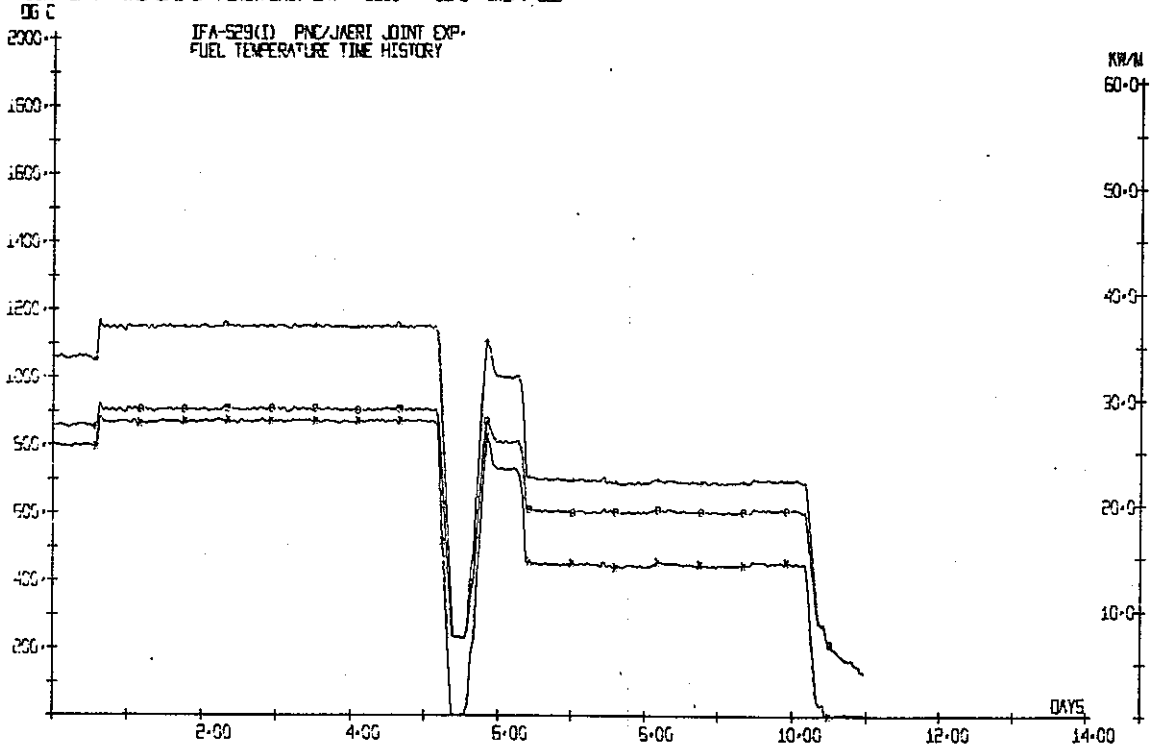

ARG= DAY * TF=1 ** TF=2 *** HRTF1

*

OECD HALDEN REACTOR PROJECT

DATA FROM 1 SEPT 81 0 HRS TO 14 SEPT 81 2345 HRS
 BURN-UP AT THE END OF FIRST/LAST DAY 5577 5876 MWDT UO2

PLOT 126

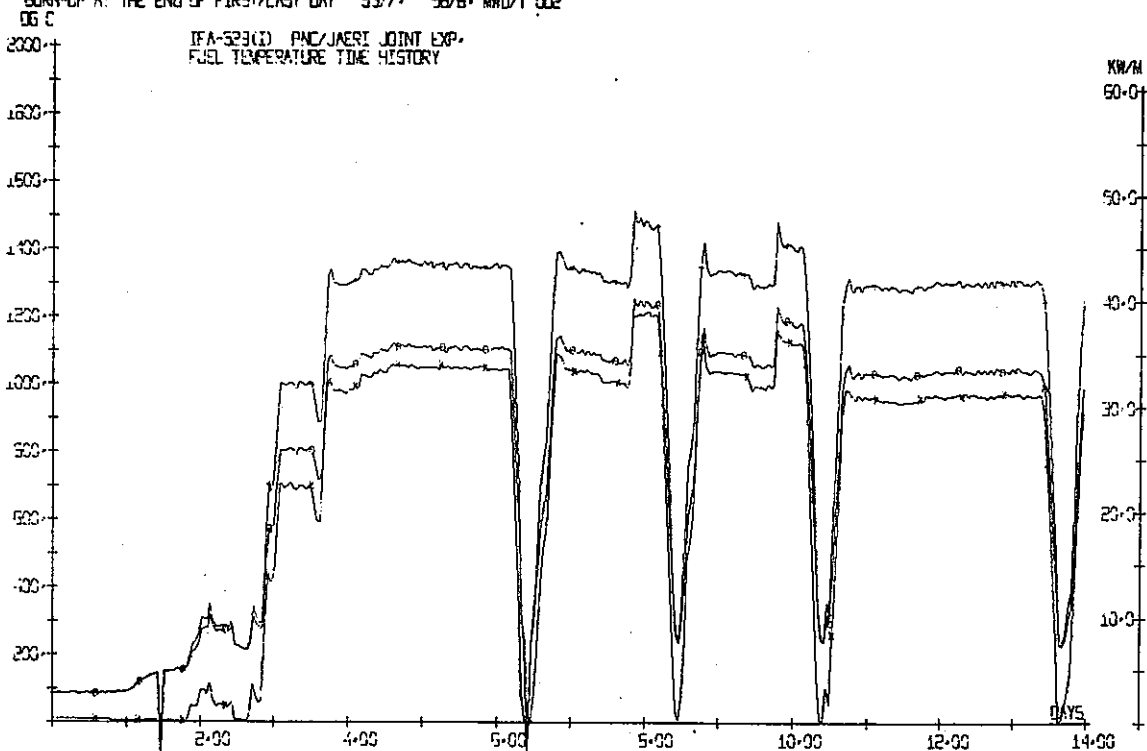

ARG= DAY * TF=1 ** TF=2 *** HRTF1

*

OECD HALDEN REACTOR PROJECT
 DATA FROM 15 SEPT 81 0 HRS TO 29 SEPT 81 2345 HRS
 BURN-UP AT THE END OF FIRST/LAST DAY 5906 6325 MWDT UO2

PLOT 125

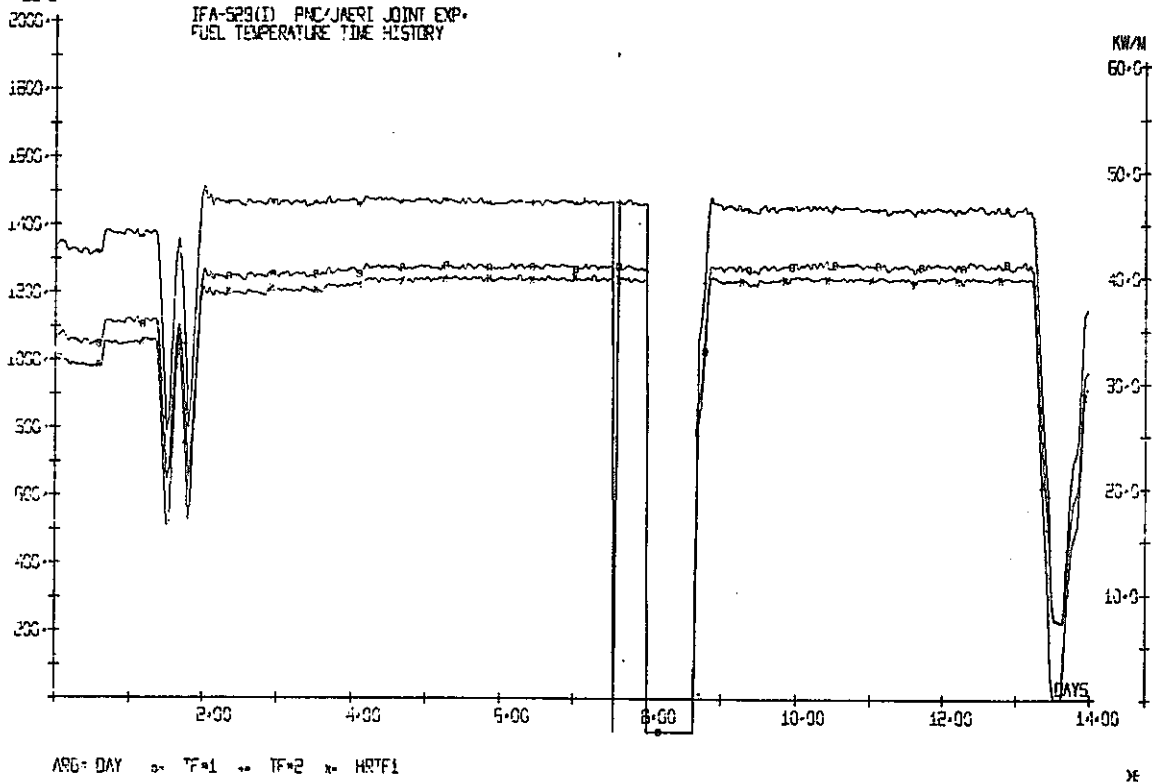

OECD HALDEN REACTOR PROJECT
 DATA FROM 29 SEPT 81 0 HRS TO 4 OCT 81 2345 HRS
 BURN-UP AT THE END OF FIRST/LAST DAY 6352 6413 MWDT UO2

PLOT 126

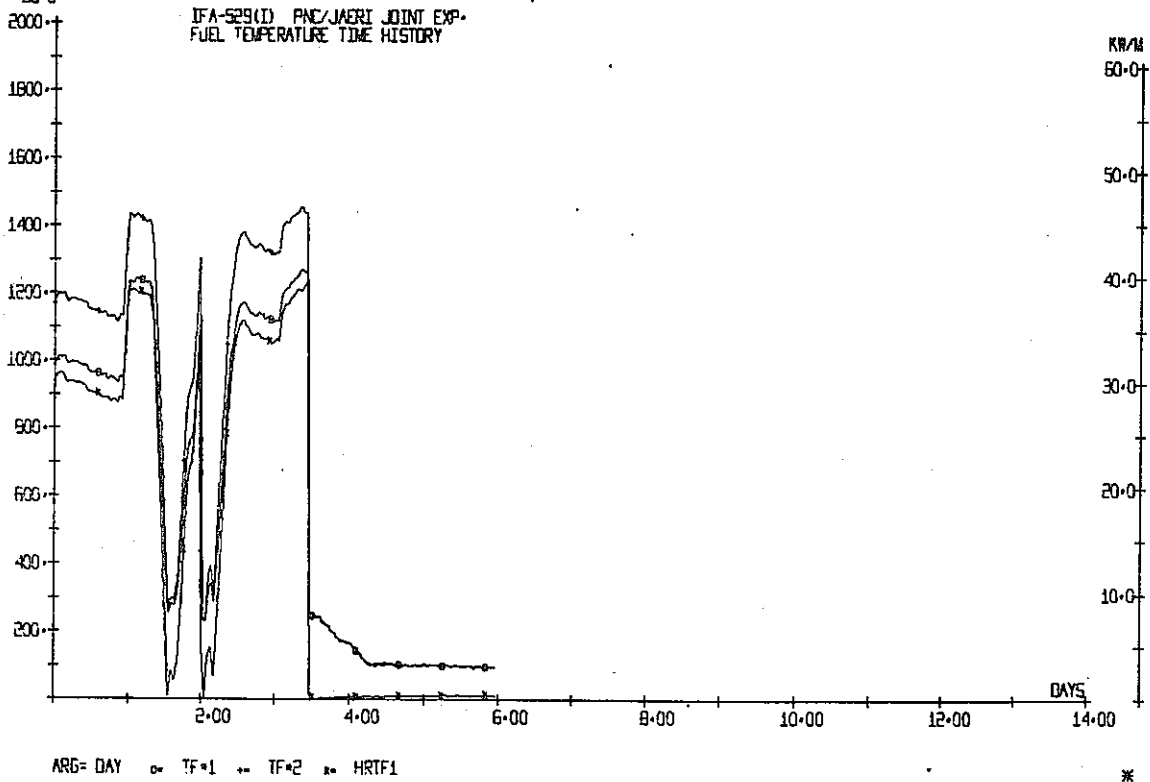

OECD HALDEN REACTOR PROJECT

DATA FROM 21 DEC 81 0 HRS TO 31 DEC 81 23 HRS
 BURN-UP AT THE END OF FIRST/LAST DAY 6417 6526 MWDT UOZ

PLOT 126

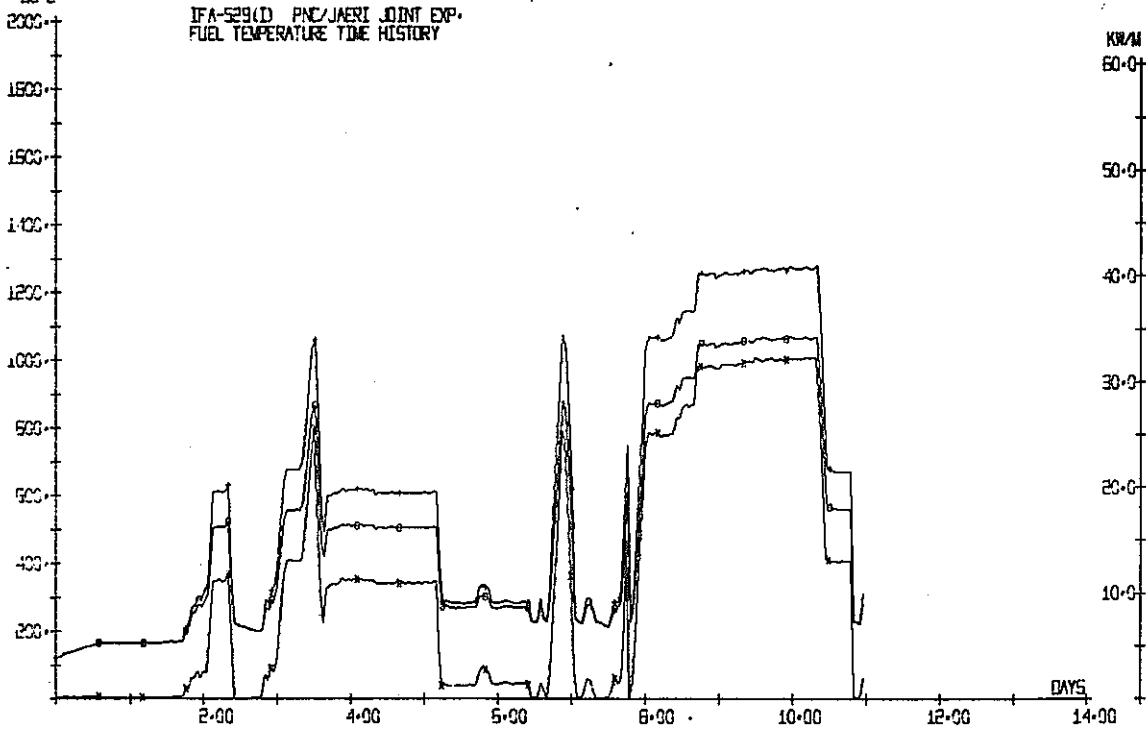

ARG= DAY * TF=1 ** TF=2 ** HRTF1 *

OECD HALDEN REACTOR PROJECT

DATA FROM 1 JAN 82 0 HRS TO 14 JAN 82 23 HRS
 BURN-UP AT THE END OF FIRST/LAST DAY 6531 6651 MWDT UOZ

PLOT 126

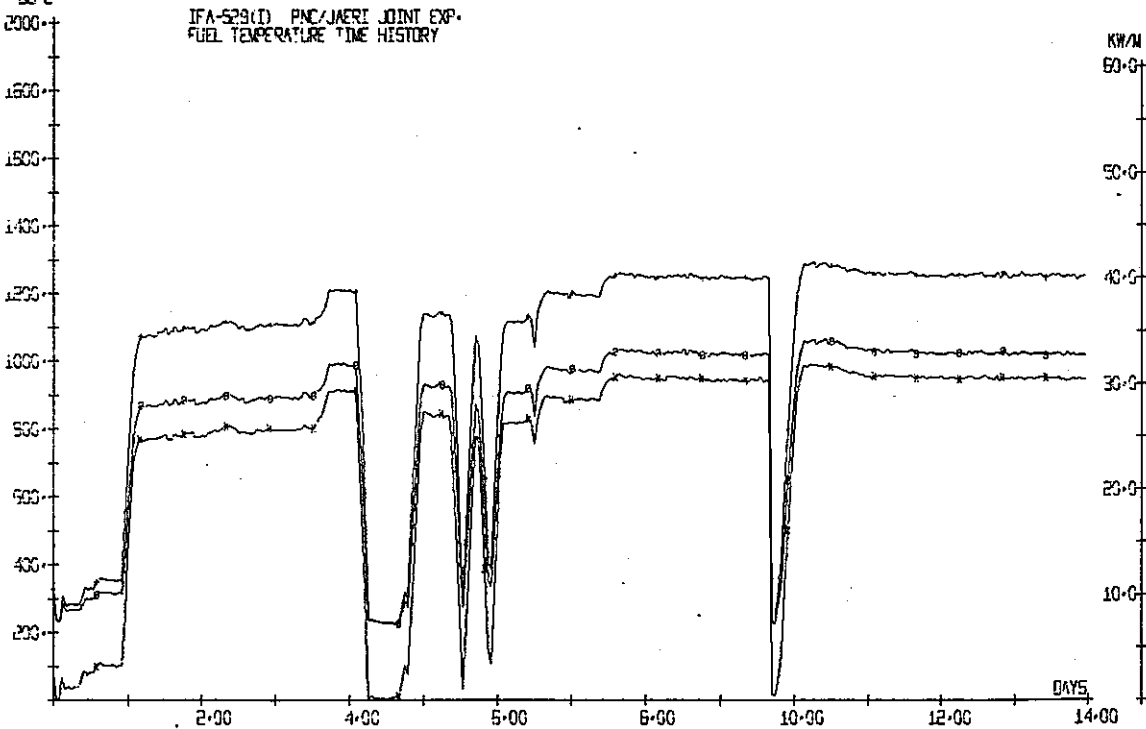

ARG= DAY * TF=1 ** TF=2 ** HRTF1 *

OECD HALDEN REACTOR PROJECT
DATA FROM 15 JAN 82 0 HRS TO 28 JAN 82 23:45 HRS
BURN-UP AT THE END OF FIRST/LAST DAY 5860- 7251 MWDT UO2

PLOT 125

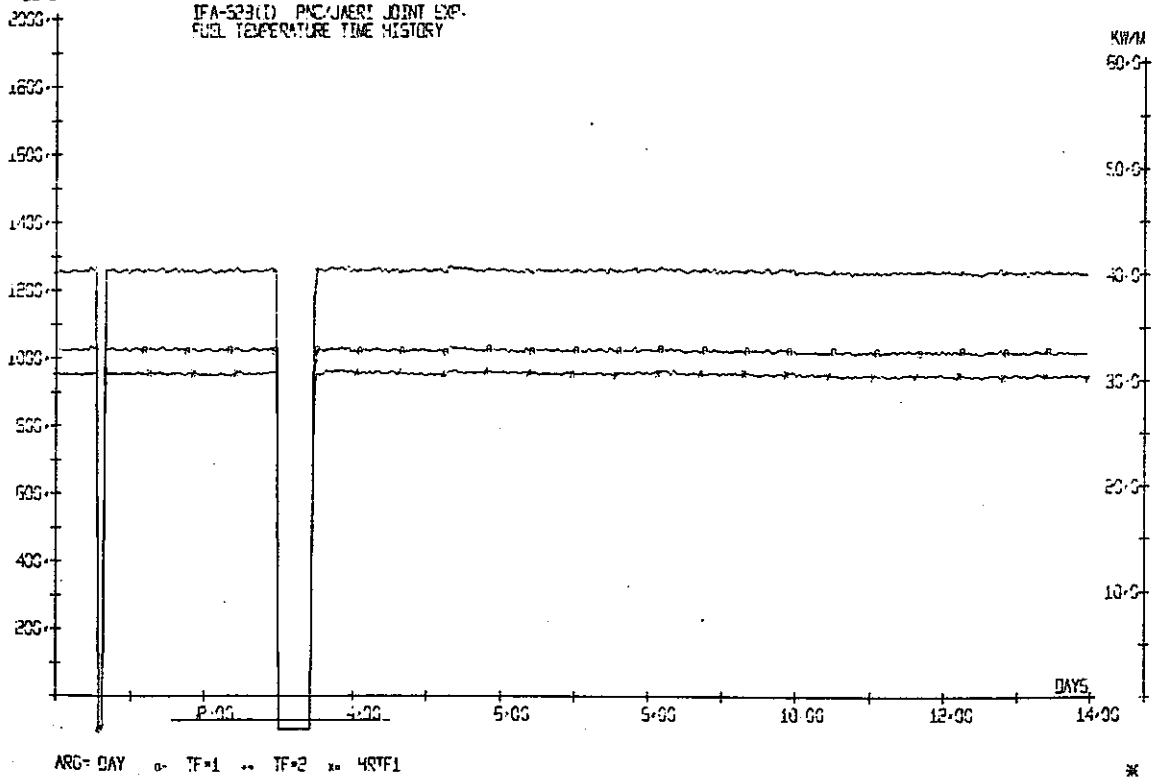

OECD HALDEN REACTOR PROJECT
DATA FROM 31 JAN 82 0 HRS TO 13 FEB 82 23:45 HRS
BURN-UP AT THE END OF FIRST/LAST DAY 7337- 7517 MWDT UO2

PLOT 126

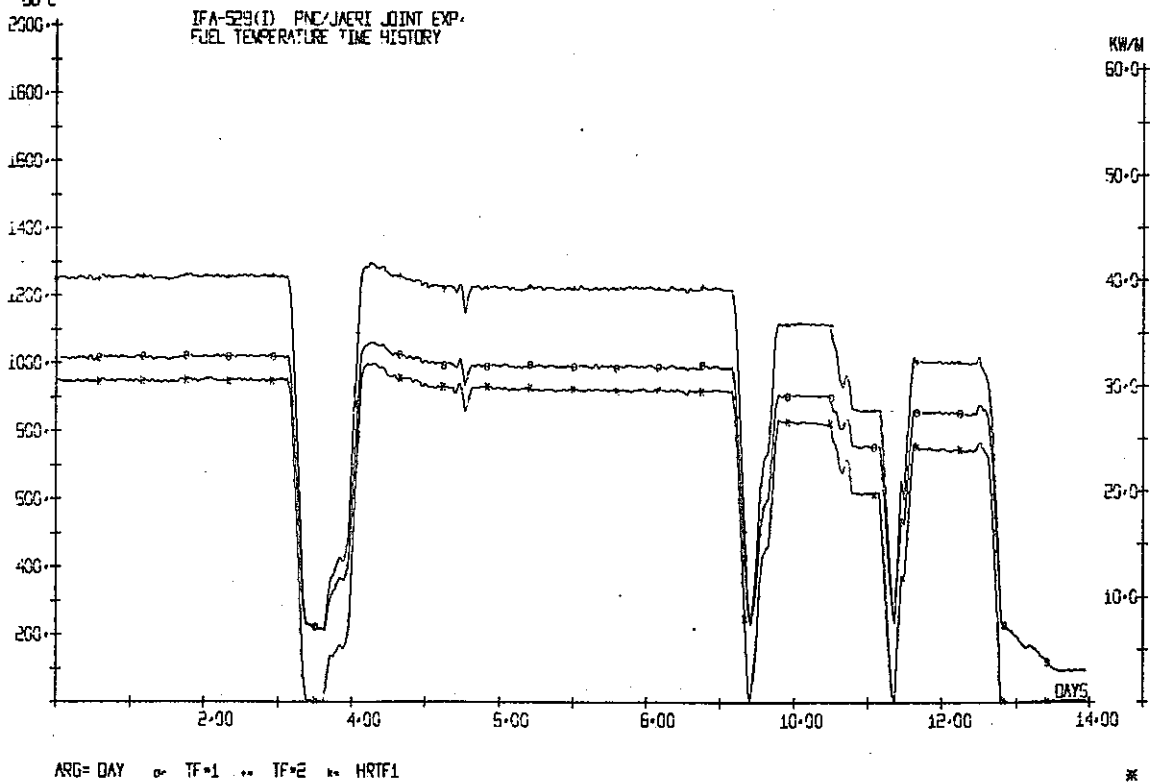

OECD HALDEN REACTOR PROJECT

DATA FROM 25 FEB 92 0 HRS TO 10 MAR 92 23:45 HRS
BURN-UP AT THE END OF FIRST/LAST DAY 7518 7343 MWDT UO2

PLOT 126

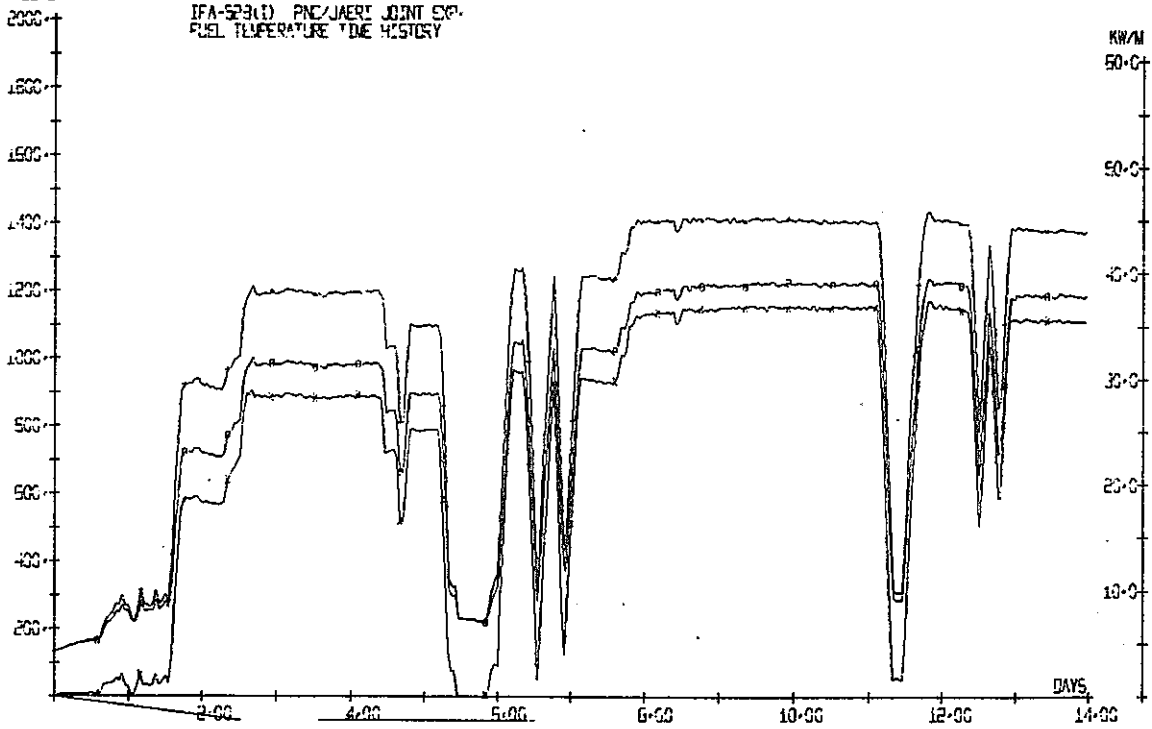

ARG= DAY TF=1 TF=2 HRTF1

*

OECD HALDEN REACTOR PROJECT

DATA FROM 11 MAR 92 0 HRS TO 24 MAR 92 23:45 HRS
BURN-UP AT THE END OF FIRST/LAST DAY 7953 6271 MWDT UO2

PLOT 126

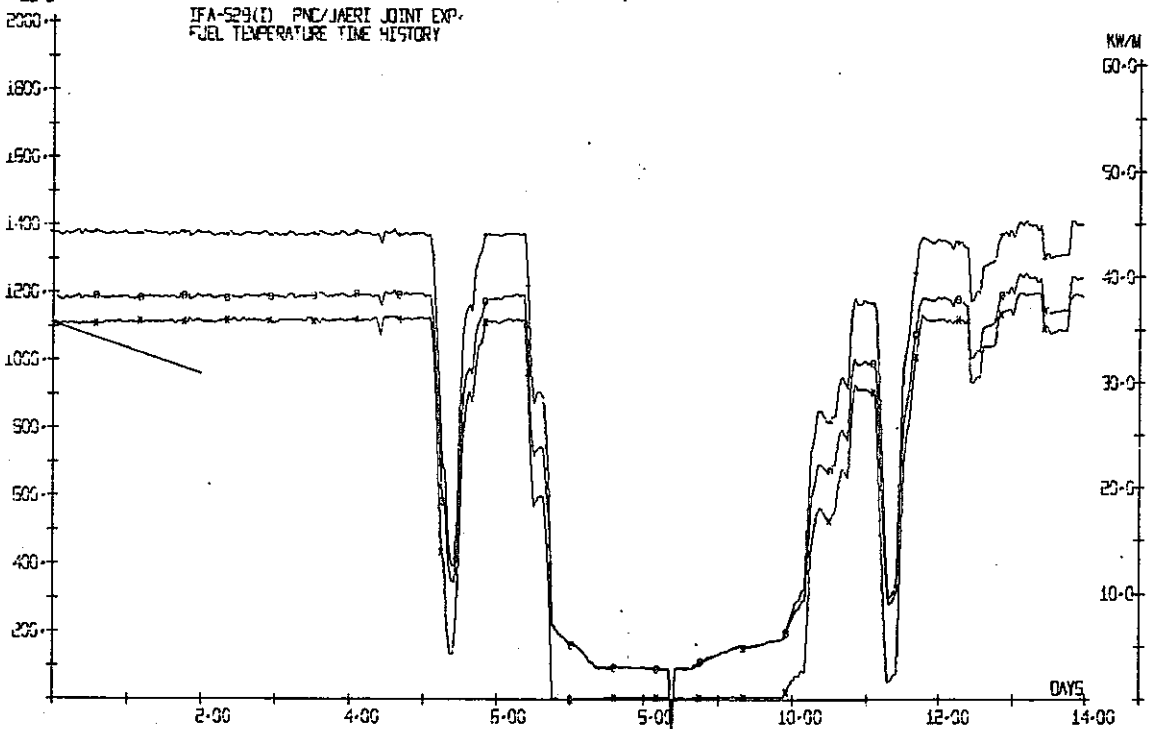

ARG= DAY TF=1 TF=2 HRTF1

*

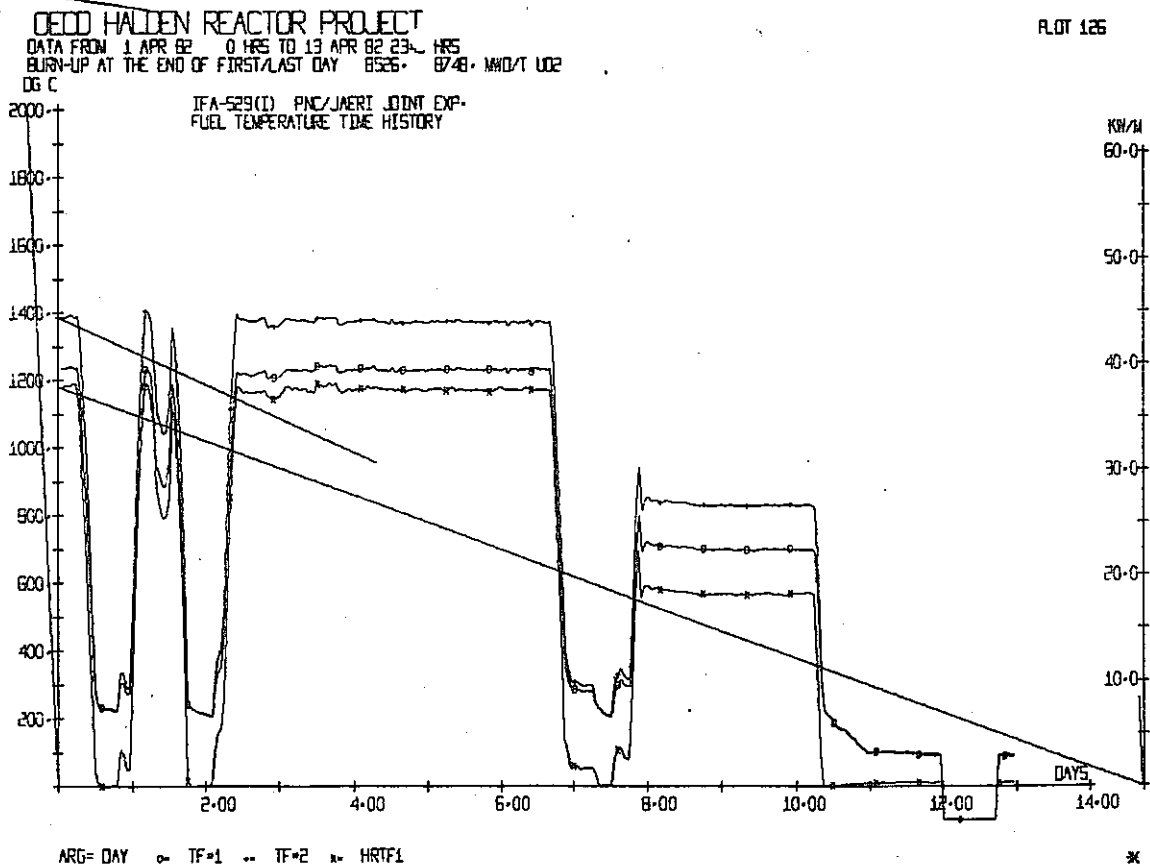
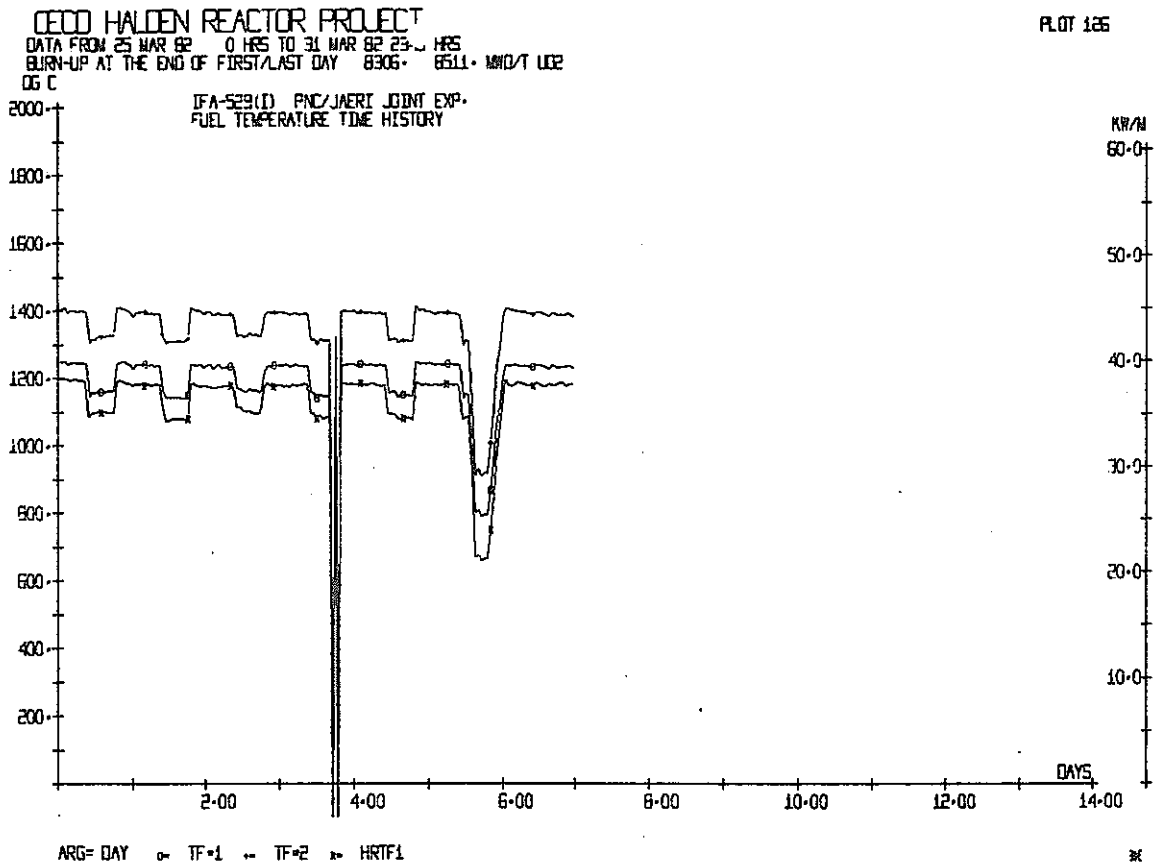

OECD HALDEN REACTOR PROJECT

DATA FROM 19 MAY 82 0 HRS TO 1 JUNE 82 2345 HRS
 BURN-UP AT THE END OF FIRST/LAST DAY 8213 8433 WWD/T UO2
 UG C

PLOT 125

IFA-529(1) PNC/JAERI JOINT EXP.
 FUEL TEMPERATURE TIME HISTORY

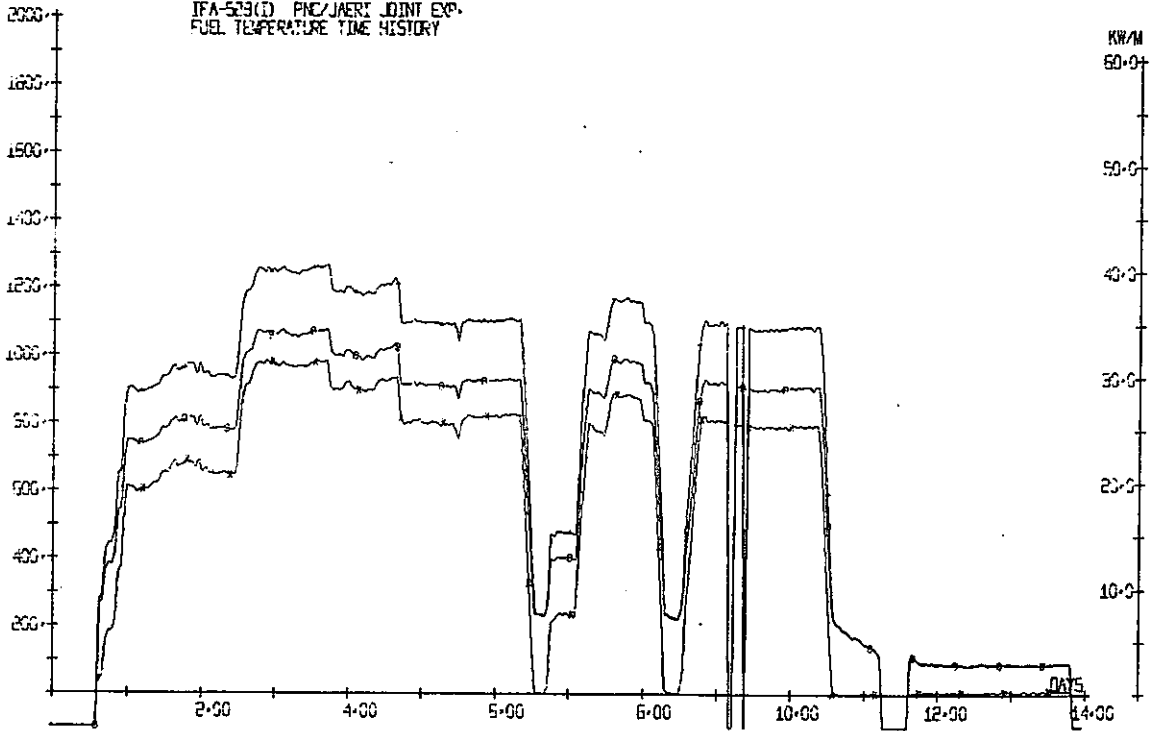

ARG= DAY o TF*1 s TF*2 x HRTF1

*

OECD HALDEN REACTOR PROJECT

DATA FROM 15 JUNE 82 0 HRS TO 27 JUNE 82 2345 HRS
 BURN-UP AT THE END OF FIRST/LAST DAY 8512 8738 WWD/T UO2
 UG C

PLOT 126

IFA-529(1) PNC/JAERI JOINT EXP.
 FUEL TEMPERATURE TIME HISTORY

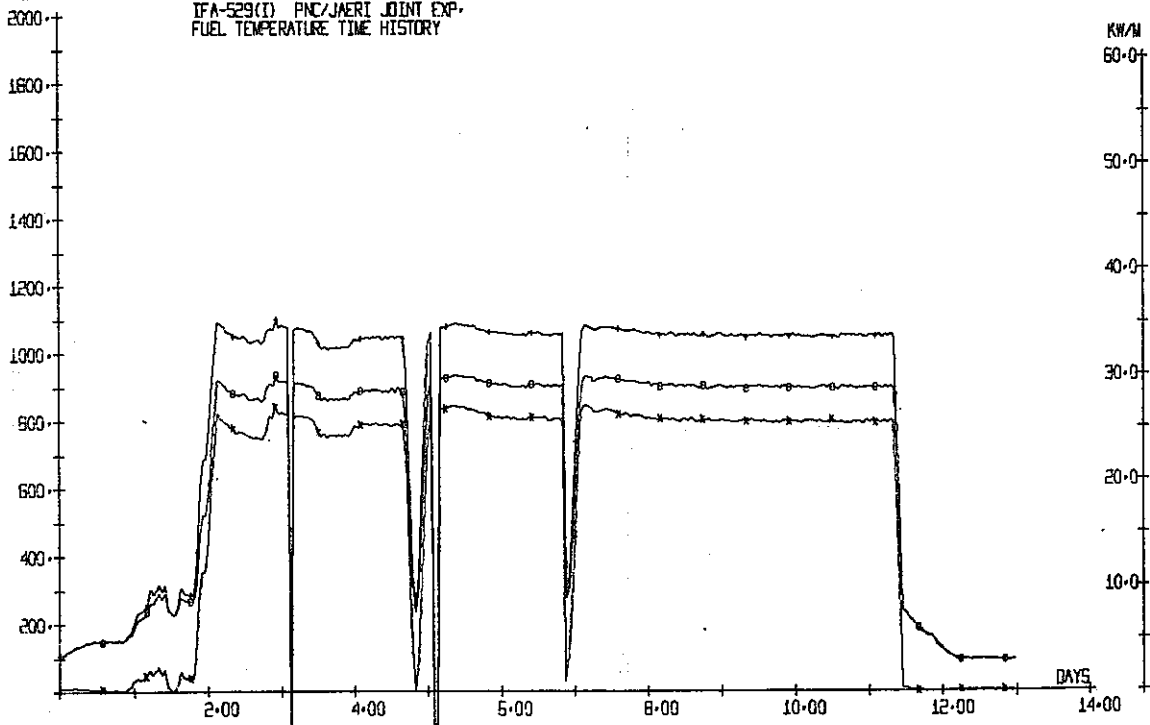

ARG= DAY o TF*1 s TF*2 x HRTF1

*

OEDD HALDEN REACTOR PROJECT
DATA FROM 1 JULY82 0 HRS TO 14 JULY82 2300 HRS
BURN-UP AT THE END OF FIRST/LAST DAY 5739 5664 MWDT UO2

PLOT 126

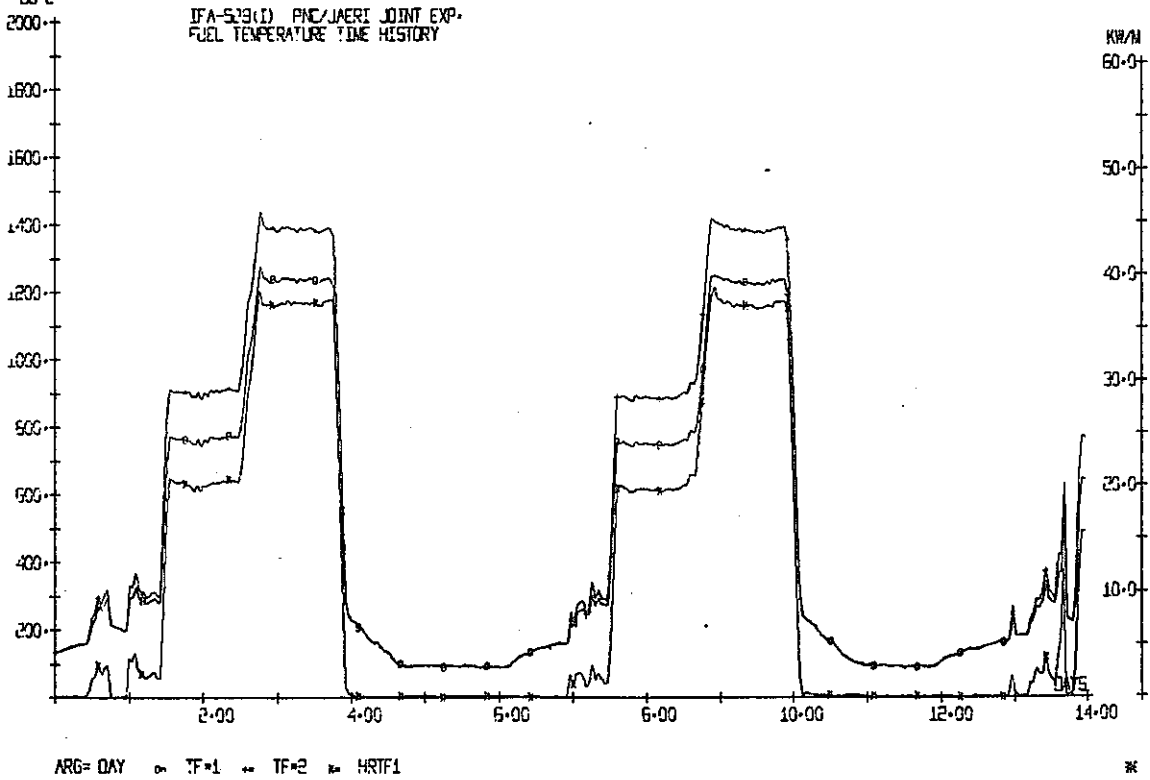

OEDD HALDEN REACTOR PROJECT
DATA FROM 15 JULY82 0 HRS TO 28 JULY82 2300 HRS
BURN-UP AT THE END OF FIRST/LAST DAY 8903 9109 MWDT UO2

PLOT 126

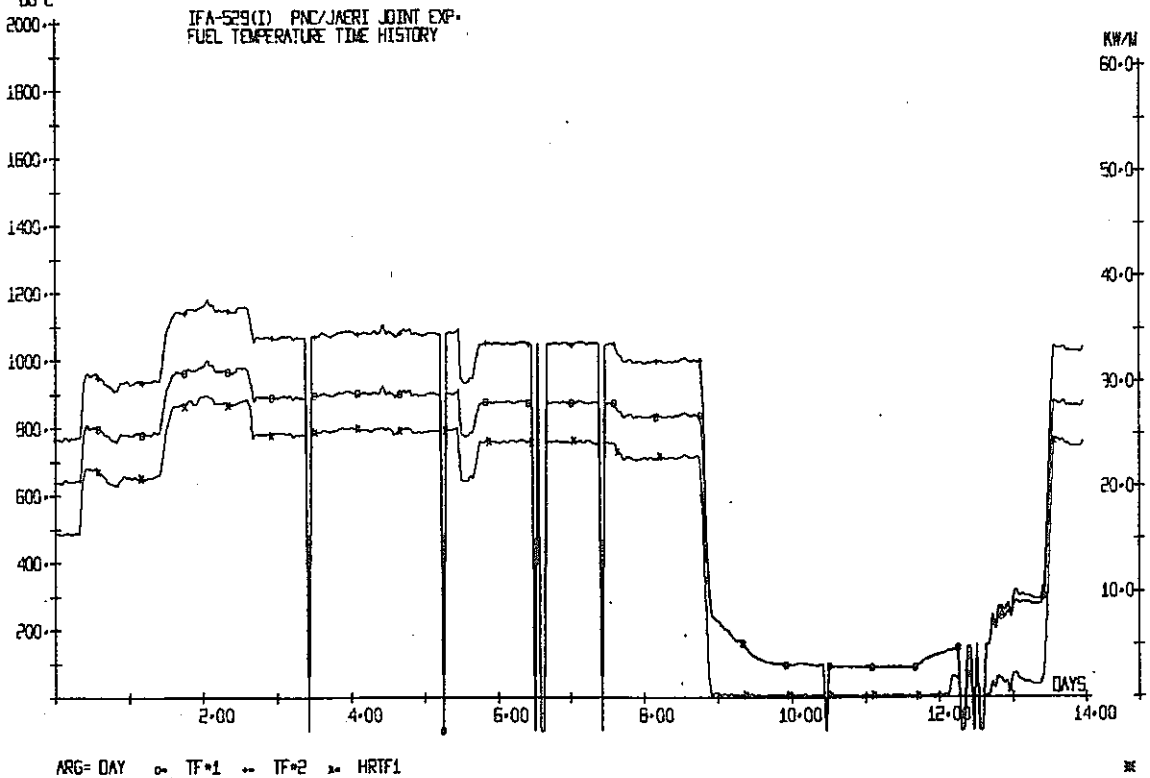

OEDD HALDEN REACTOR PROJECT

DATA FROM 29 JULY 82 0 HRS TO 7 AUG 82 2300 HRS
 BURN-UP AT THE END OF FIRST/LAST DAY 9135 9162 MWD/T UOZ

PLOT 125

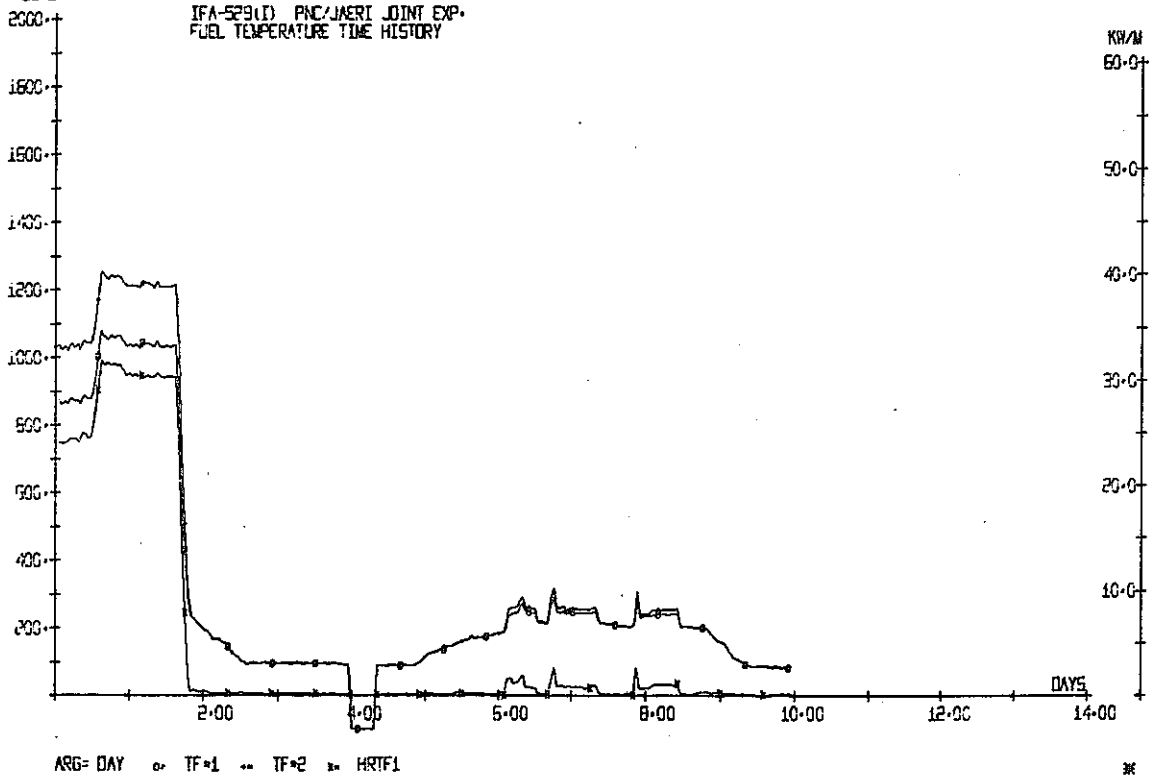

OEDD HALDEN REACTOR PROJECT

DATA FROM 12 AUG 82 0 HRS TO 24 AUG 82 2300 HRS
 BURN-UP AT THE END OF FIRST/LAST DAY 9159 9305 MWD/T UOZ

PLOT 125

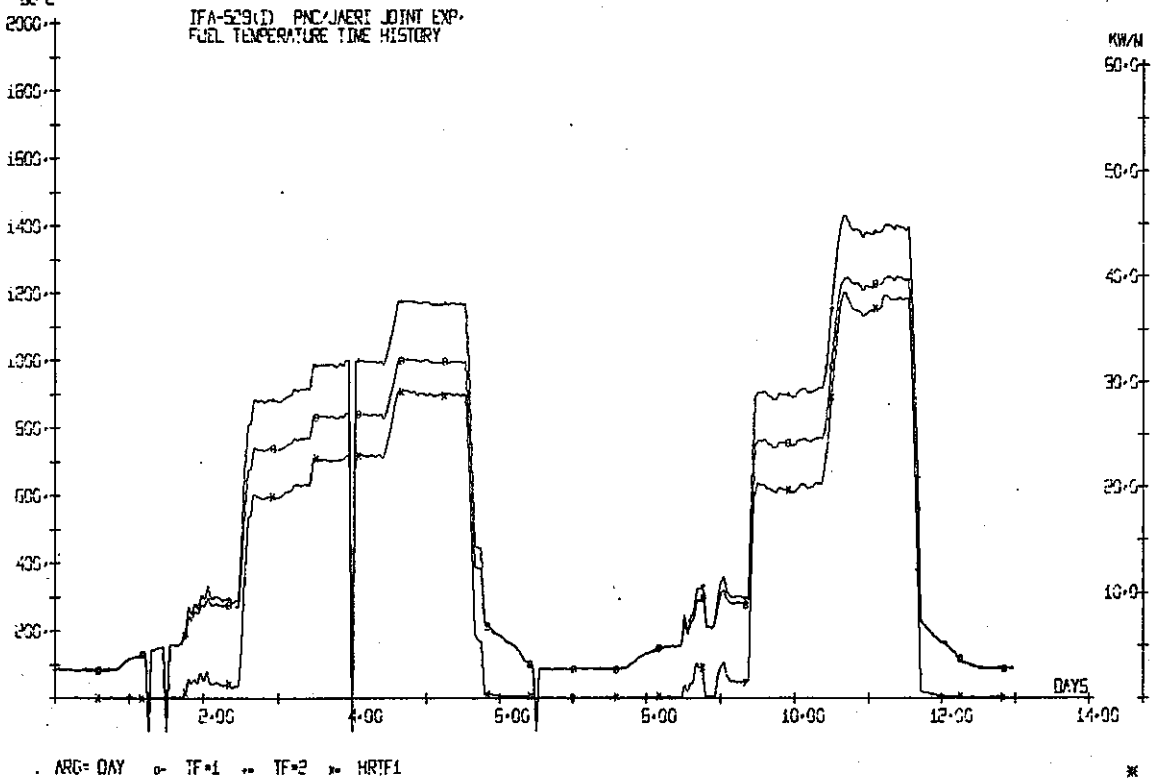

OECD HALDEN REACTOR PROJECT
 DATA FROM 19 SEPT 82 0 HRS TO 30 SEPT 82 2300 HRS
 BURN-UP AT THE END OF FIRST/LAST DAY 9306 9486 MWDT UO2
 DG C

PLOT 125

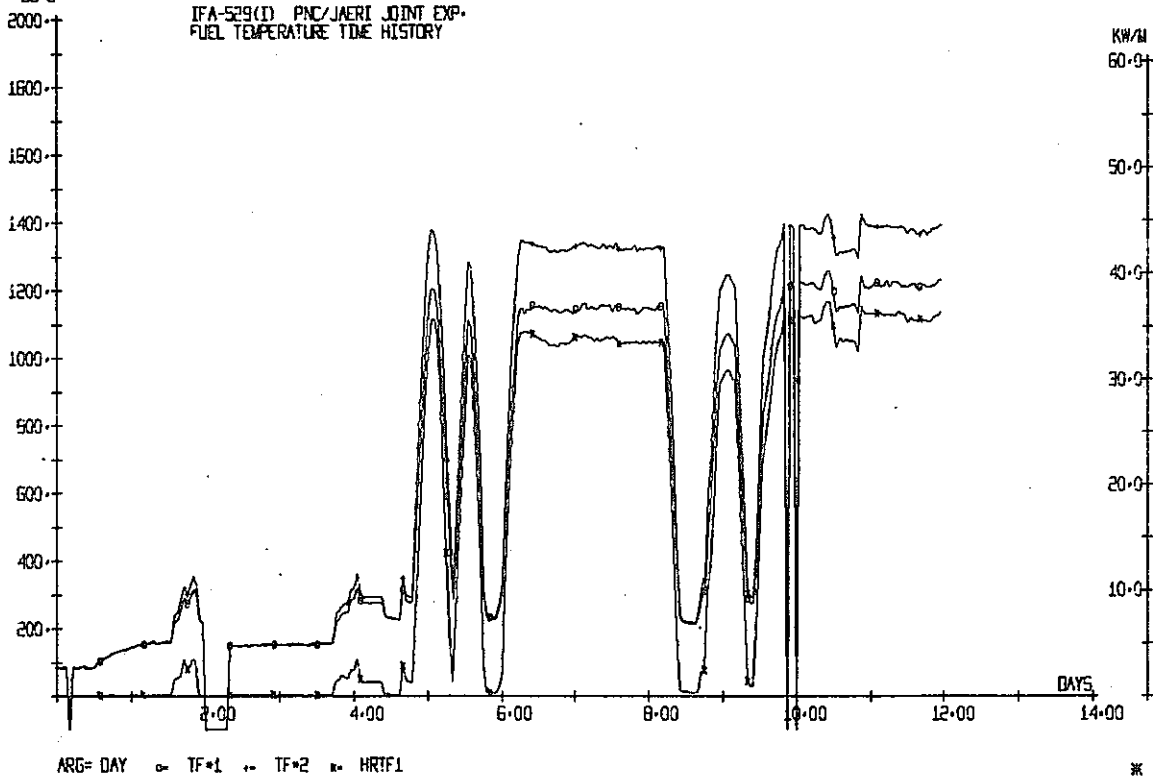

OECD HALDEN REACTOR PROJECT
 DATA FROM 1 OCT 82 0 HRS TO 14 OCT 82 2300 HRS
 BURN-UP AT THE END OF FIRST/LAST DAY 9590 9842 MWDT UO2
 DG C

PLOT 126

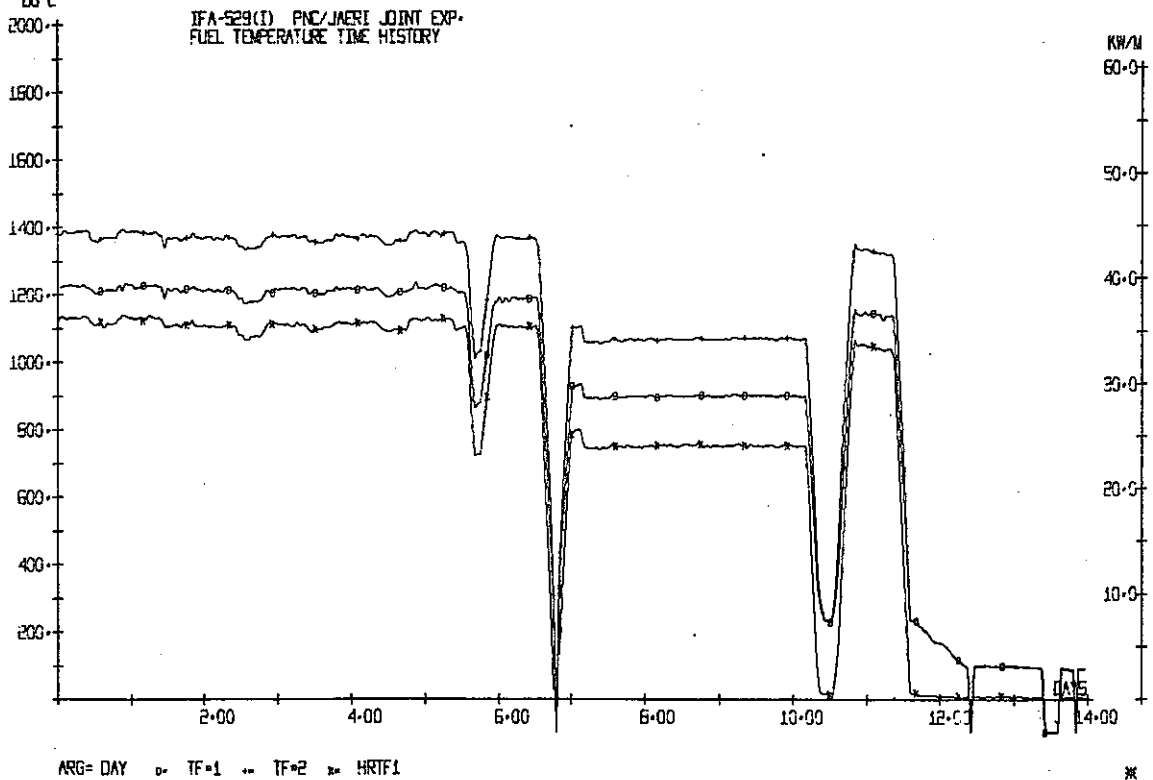

OECD HALDEN REACTOR PROJECT
DATA FROM 15 OCT 82 0 HRS TO 25 OCT 82 2300 HRS
BURN-UP AT THE END OF FIRST/LAST DAY 9942 10019 MWDT UO2
06 C

PLOT 125

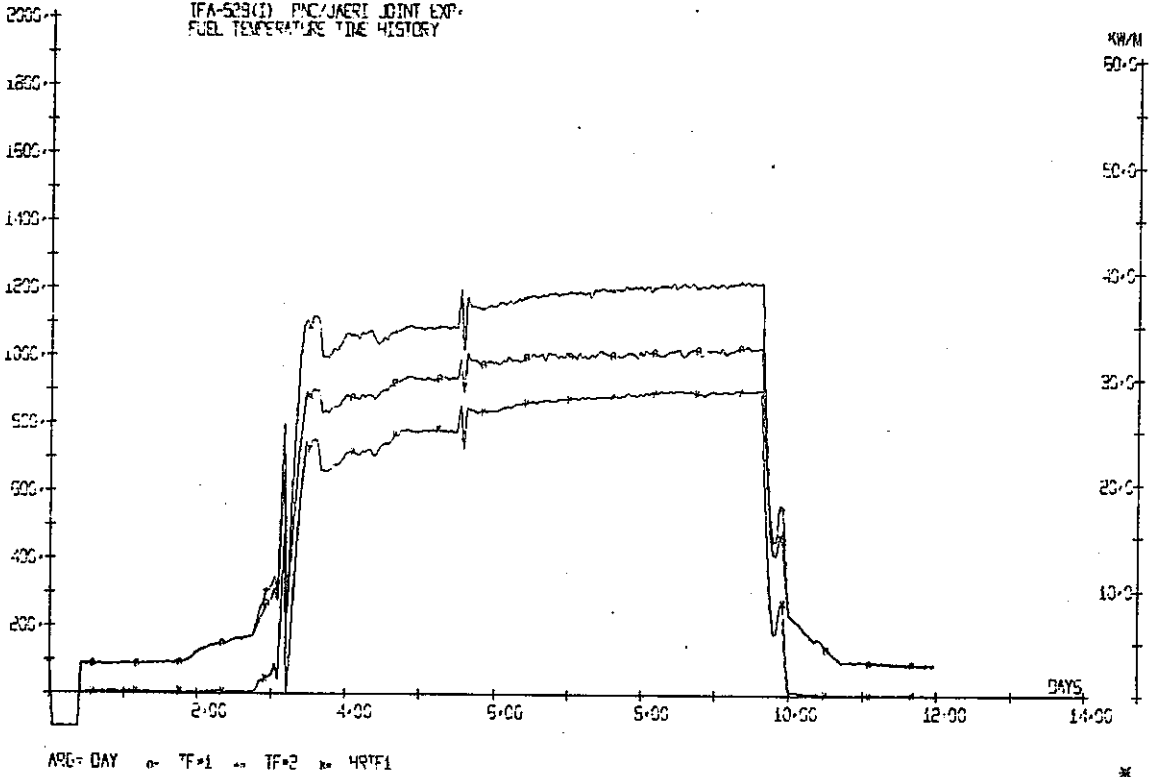

OECD HALDEN REACTOR PROJECT
DATA FROM 5 NOV 82 0 HRS TO 20 NOV 82 2300 HRS
BURN-UP AT THE END OF FIRST/LAST DAY 10019 10216 MWDT UO2
06 C

PLOT 125

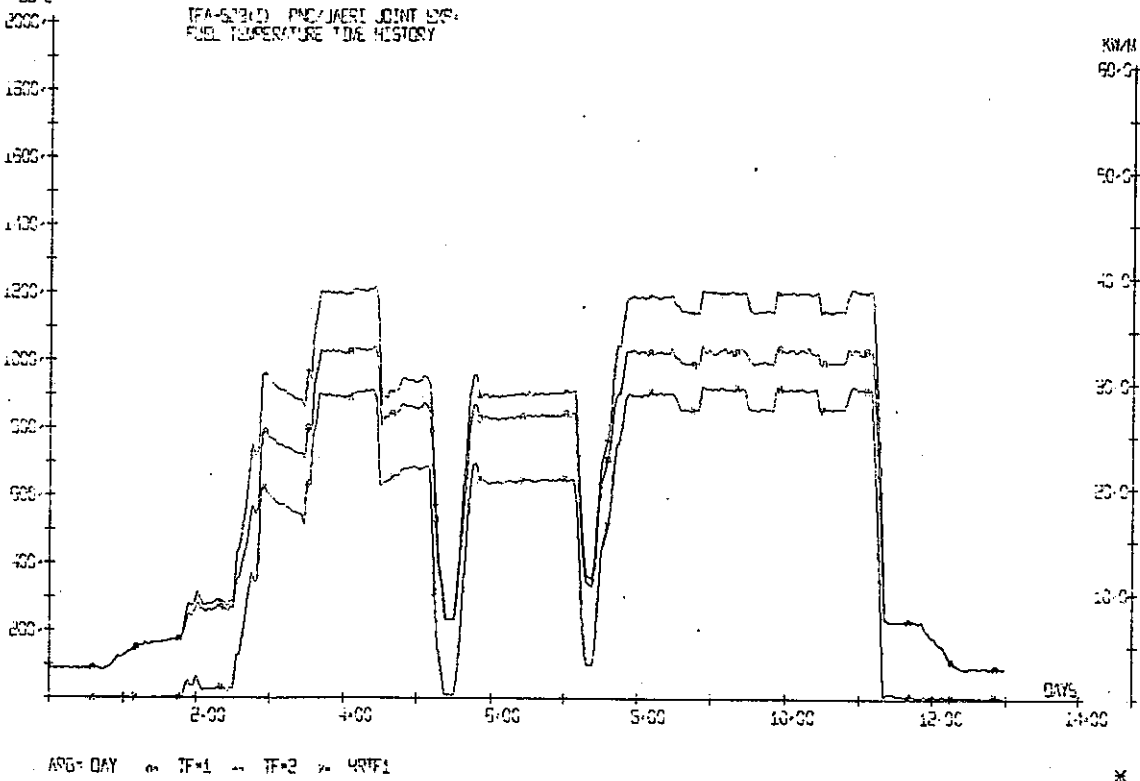

OECD HALDEN REACTOR PROJECT

DATA FROM 24 NOV 62 0 HRS TO 7 DEC 62 2300 HRS
 BURN-UP AT THE END OF FIRST/LAST DAY 10246 10578 MWDT UO2
 DG C

PLOT 125

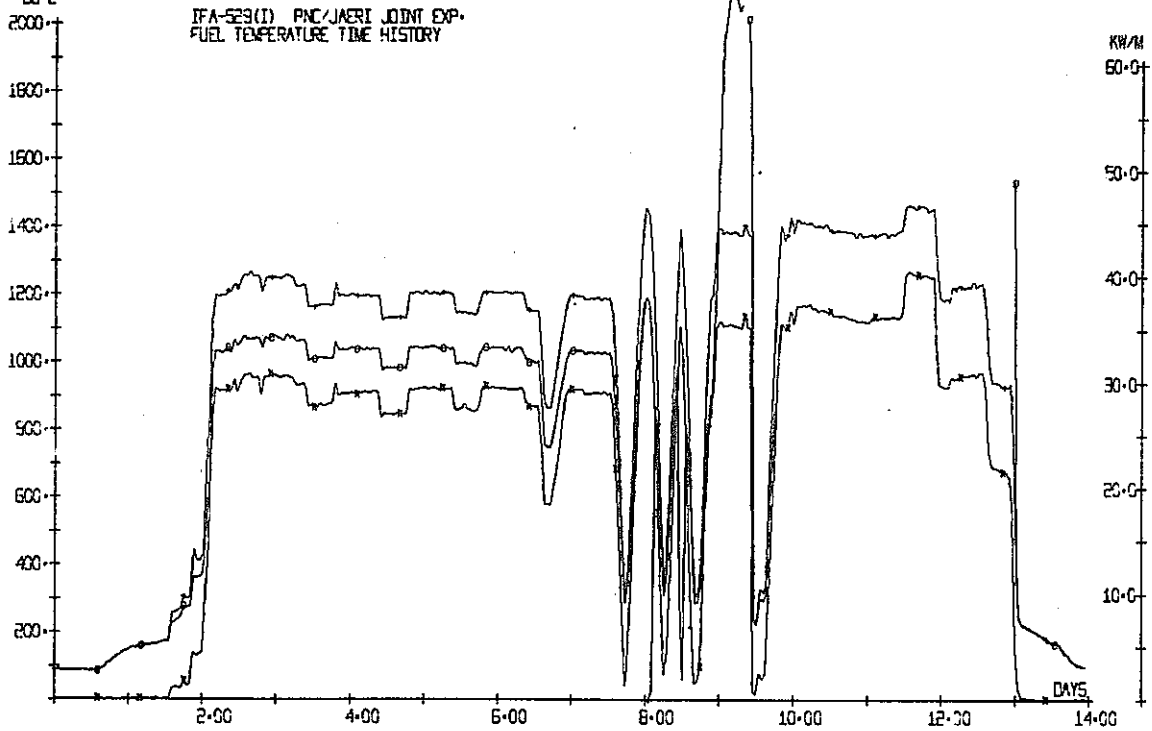

ARG= DAY o TF=1 .. TF=2 x HRTF1

*

OECD HALDEN REACTOR PROJECT

DATA FROM 18 DEC 62 0 HRS TO 31 DEC 62 2300 HRS
 BURN-UP AT THE END OF FIRST/LAST DAY 10581 10917 MWDT UO2
 DG C

PLOT 126

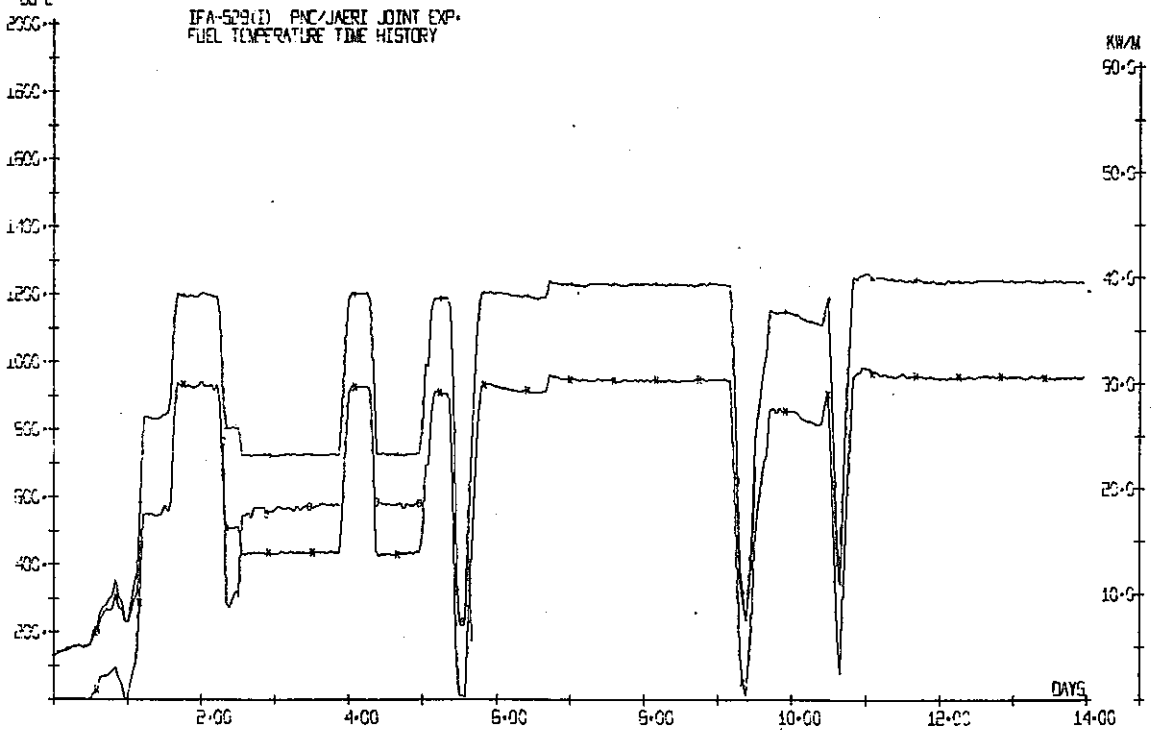

ARG= DAY o TF=1 .. TF=2 x HRTF1

*