

TN8420 86-013(2)

PNC ~~8420-86-05(2)~~

内部資料

本資料は 年 月 日付けで登録区分、
変更する。

2001. 6. 20

[技術情報室]

東海沿岸海域における流動調査

Observation of Ocean Current in Tokai Coastal Area

第2分冊 流向頻度及び流速階級頻度

1986年4月

動力炉・核燃料開発事業団
東海事業所

本資料の全部または一部を複写・複製・転載する場合は、下記にお問い合わせください。

〒319-1184 茨城県那珂郡東海村大字村松4番地49
核燃料サイクル開発機構
技術展開部 技術協力課

Inquiries about copyright and reproduction should be addressed to:
Technical Cooperation Section,
Technology Management Division,
Japan Nuclear Cycle Development Institute
4-49 Muramatsu, Tokai-mura, Naka-gun, Ibaraki, 319-1184
Japan

フ。
トに

© 核燃料サイクル開発機構 (Japan Nuclear Cycle Development Institute)
2001

東海沿岸海域における流動調査

Observation of Ocean Current in Tokai Coastal Area

第2分冊 流向頻度及び流速階級頻度

実施責任者 岩井 誠
(環境安全課長)報告者 黒須 五郎
晴山 央一
岡 努
浅野 智宏

要 旨

海洋における液体廃棄物の希釈・拡散の評価において、重要な因子のひとつに流動調査がある。東海村沿岸海域における流動調査は、再処理施設設置以前から、原研、東海区水産研、事業団等の機関により実施されており、昭和52年からは、事業団が海中放出口付近に自記式流向流速計を設置し、流動調査を行ってきた。

本報告書は、昭和52年以降、事業団が実施してきた流動調査の結果から、東海前面海域における流動特性について検討したものである。報告書の全体構成は、以下の分冊からなっている。

- 第1分冊 調査結果の概要
- 第2分冊 流向頻度及び流速階級頻度
- 第3分冊 流向別平均流速
- 第4分冊 流向・流速ベクトル
- 第5分冊 パワースペクトル解析結果
- 第6分冊 調和解析結果
- 第7分冊 プログレッシヴ・ダイアグラム

本報告書はこのうちの第2分冊として、各1ヶ月ごとの流向頻度及び流速階級頻度のデータ解析結果をまとめたものである。本資料に係る流動調査方法、データ解析方法等については、第1分冊を参照されたい。

本調査は、放出源近傍（ニア・フィールド）の拡散評価において、基本的かつ重要なデータを提供するものであり、今後とも継続してデータの蓄積を図る予定である。

目 次

はじめに	-----	1
1. 海面下3m層における流向頻度及び流速階級頻度の解析結果	-----	3
2. 海面下10m層における流向頻度及び流速階級頻度の解析結果	-----	51
3. 海面下16m層における流向頻度及び流速階級頻度の解析結果	-----	81

はじめに

東海再処理施設の運転に伴い、低レベル液体廃棄物が距岸 1.8 km に設置されている海中放出管から放出される。東海事業所では、定常的な海洋環境モニタリングとして、海水、海底土、海産生物等の定期的な採取と測定を行ない、再処理施設に起因する環境への影響の監視を行なっている。

一方、海洋における液体廃棄物の希釈・拡散の評価において、重要な因子のひとつに流動がある。東海村沿岸海域における流動調査は、再処理施設の設置以前から、原研、東海区水産研、事業団等の機関により実施されてきた。昭和52年からは、事業団が海中放出口付近の海面下3m層に自記式流向流速計を設置し、流動調査を行なっており、また、55年9月からは海面下10m層に測定点を追加し、57年7月からは海面下16m層にも測定点を追加し、現在では、1地点3層において多重層の流動調査を行なっている。

これらの調査に基づく流向・流速分布は、海洋拡散評価においては、基本的かつ重要なデータであり、また、海洋中に存在する種々の時間的・空間的スケールをもった多数の変動現象について検討することも東海沿岸海域の特性を把握するといった観点から重要なことである。これら変動現象の解析にあたって、一般的には、スケールが異なればそれを支配する力学的要因も異なってくることから、事象をそれぞれスケール別に分解し、分類することが必要となる。

本報告書は、これまでの流動調査の結果から、流向・流速の分布状況、パワー・スペクトル解析、潮流の調和解析、プログレッシブ・ダイアグラム等の解析により、海中放出口付近の流動特性を検討を行なった報告書の第2分冊として、各1ヶ月ごとの流向頻度及び流速階級頻度のデータ解析結果をまとめたものである。なお、各年間及び四季別の解析結果については、第1分冊にまとめている。

本調査は、放出源近傍（ニア・フィールド）の拡散評価において、基本的かつ重要なデータを提供するものであり、今後とも継続してデータの蓄積を図る予定である。

なお、本報告書の見方は以下のとおりである。

流向頻度

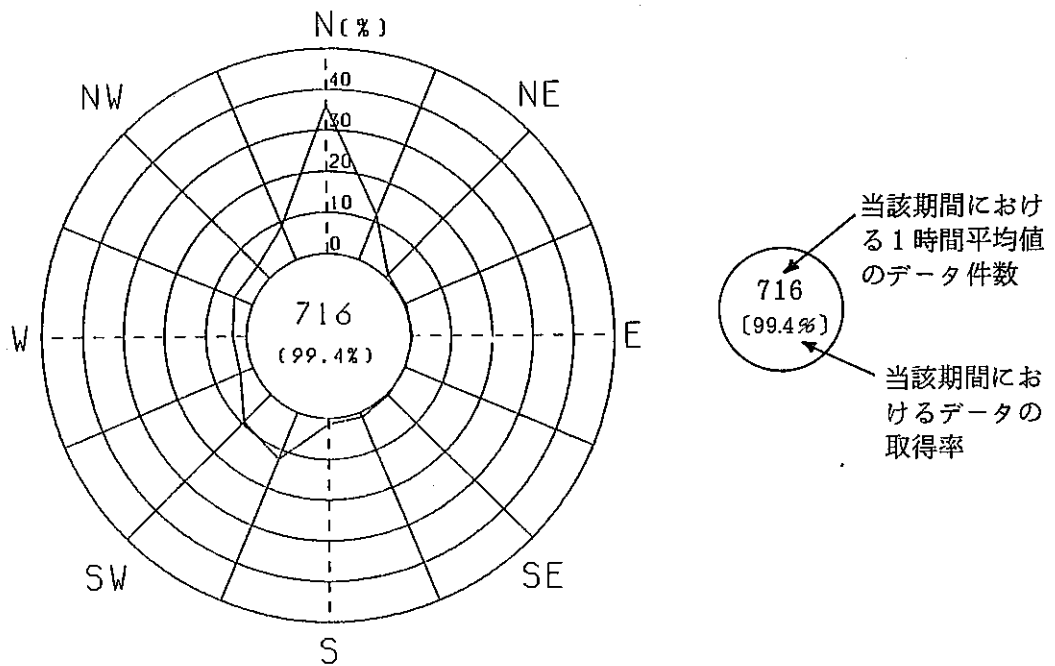

流速階級頻度

右列の数字は、グラフ横軸の各番号に相当する流速階級を表す。

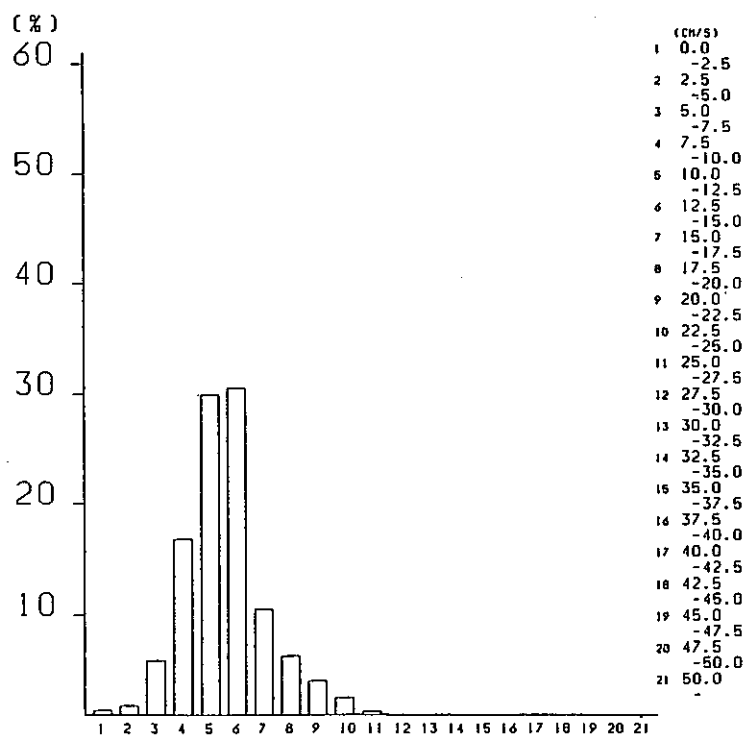

1、海面下3 m層における流向頻度及び流速階級頻度の解析結果

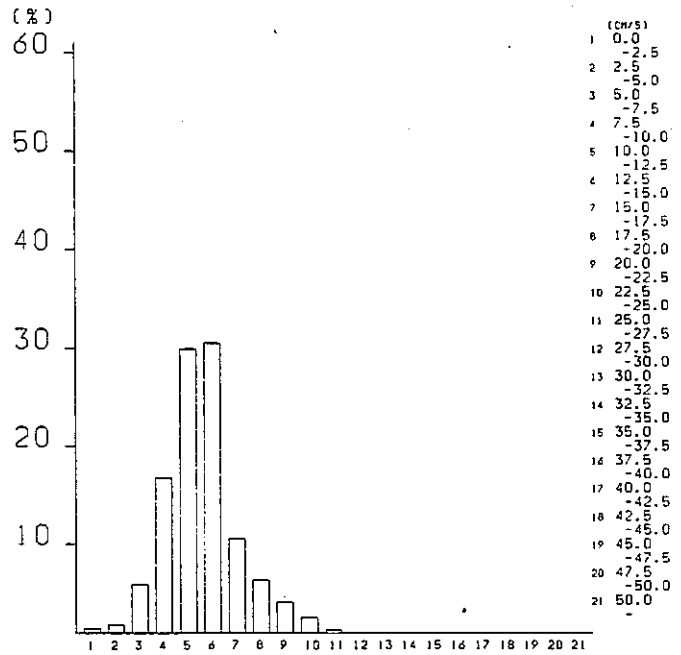
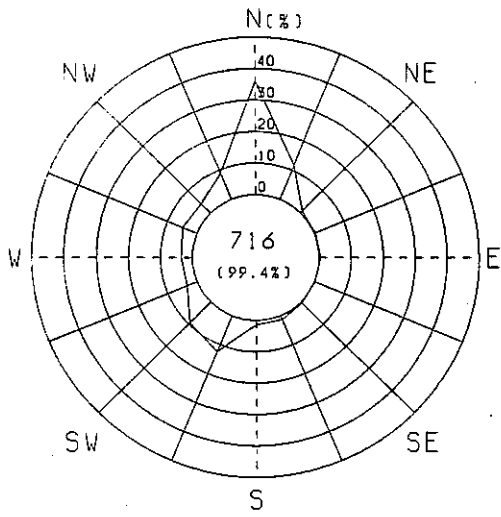

1978/1/2 0:00 - 1978/1/31 23:55

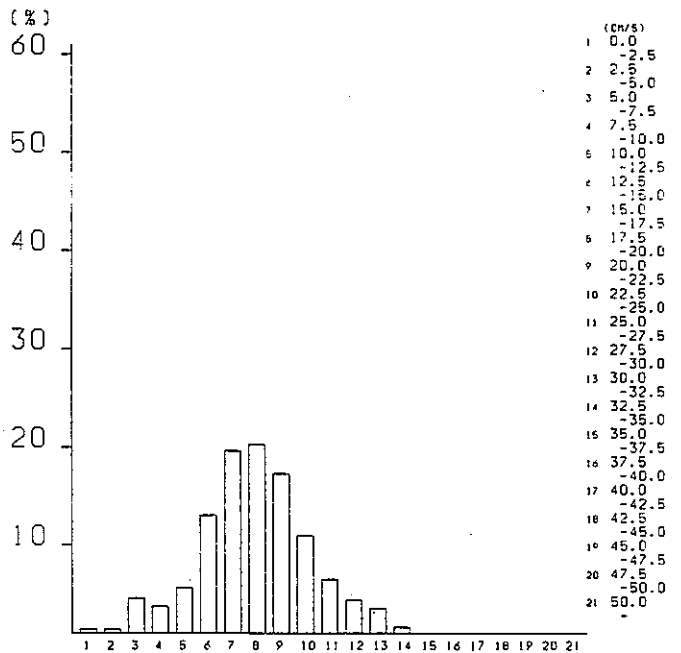
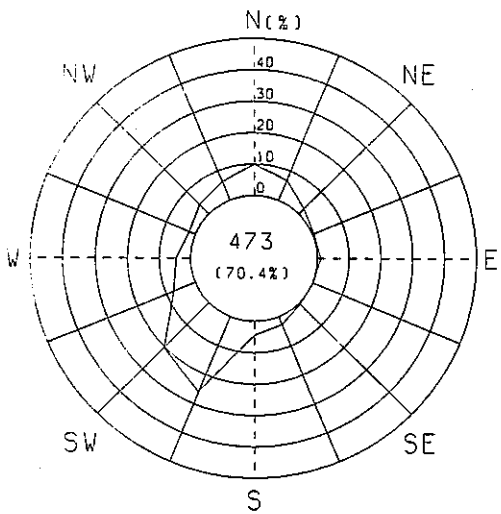

1978/2/1 0:00 - 1978/2/28 23:55

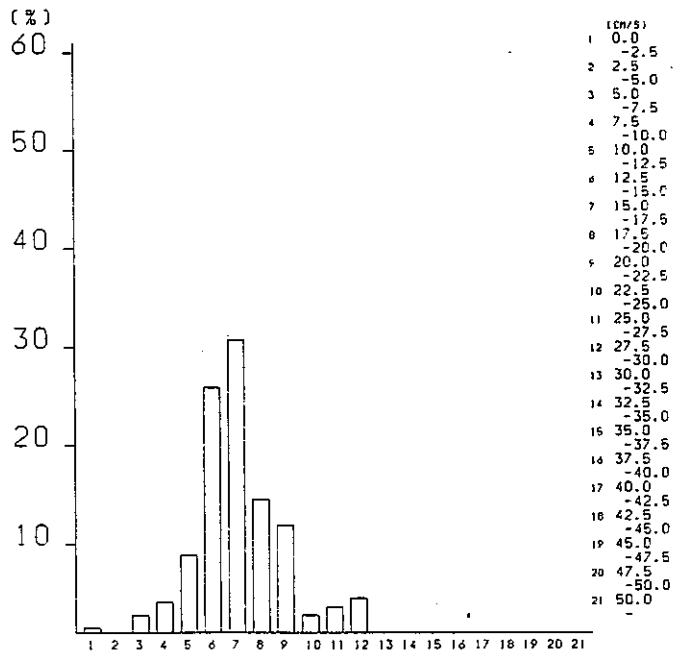
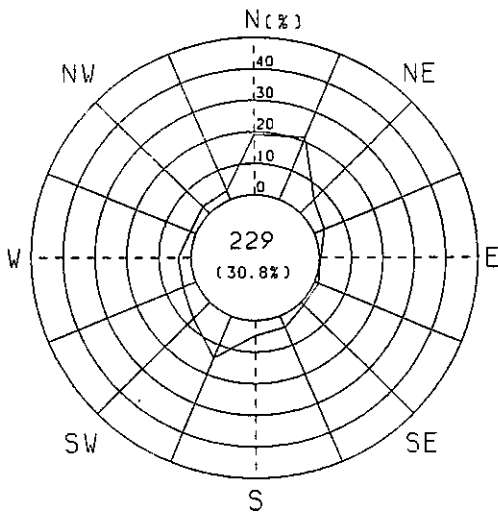

1978/3/1 0:00 - 1978/3/31 23:55

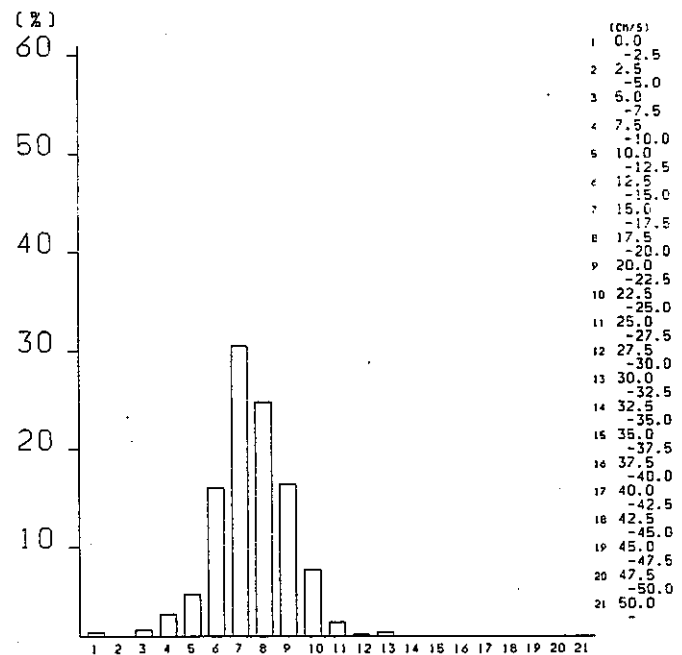
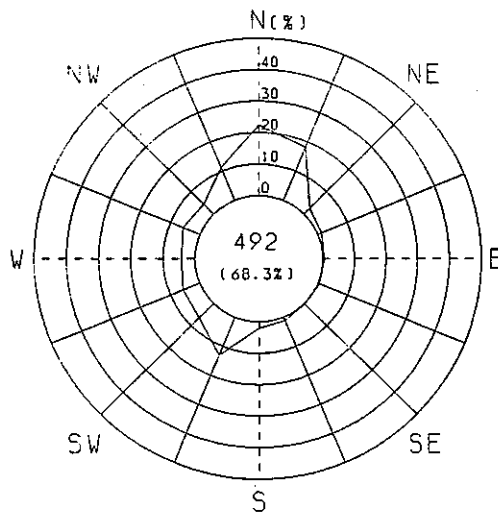

1978/4/1 0:00 - 1978/4/30 23:55

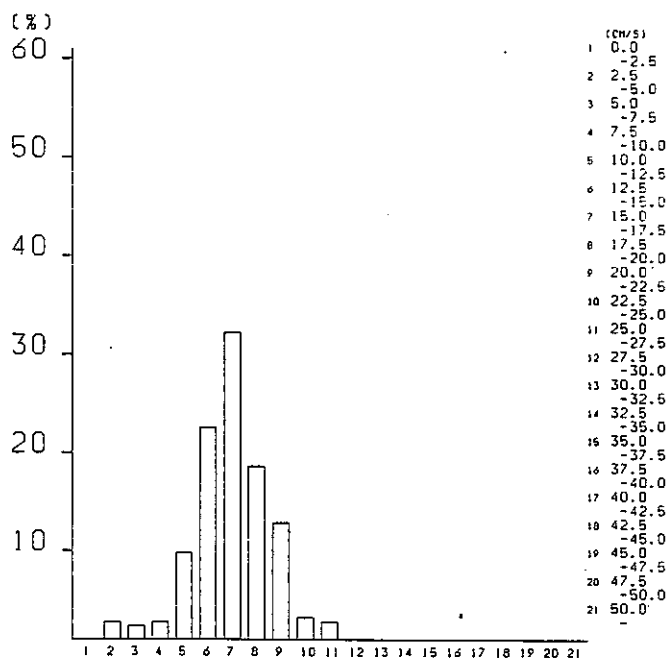
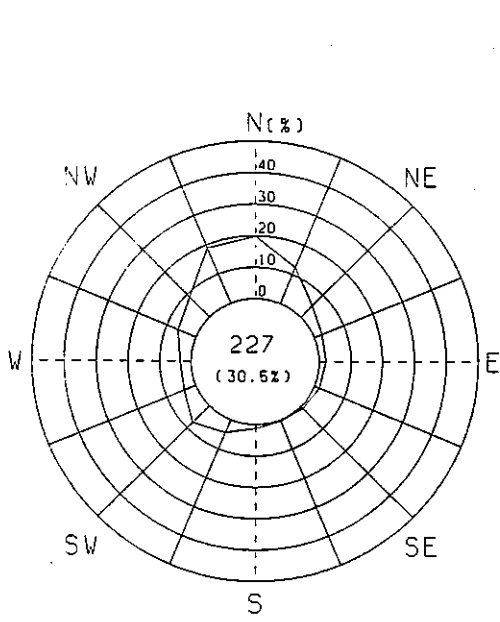

1978/5/1 0:00 - 1978/5/31 23:55

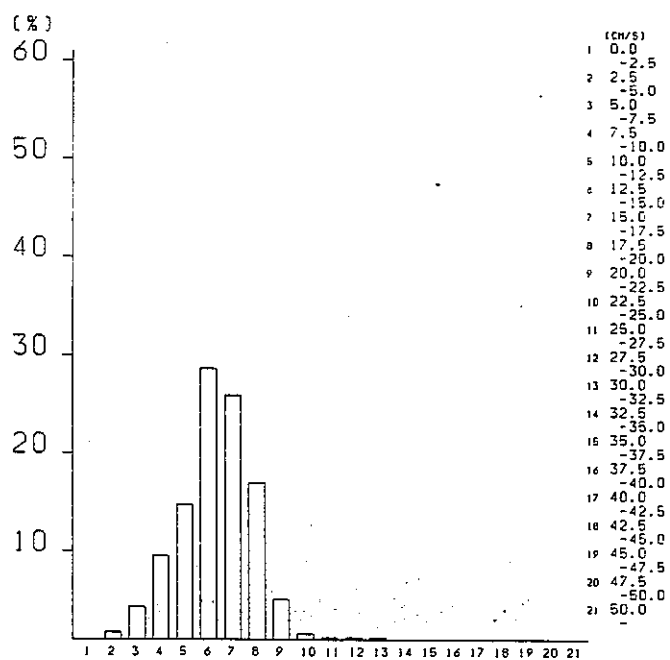
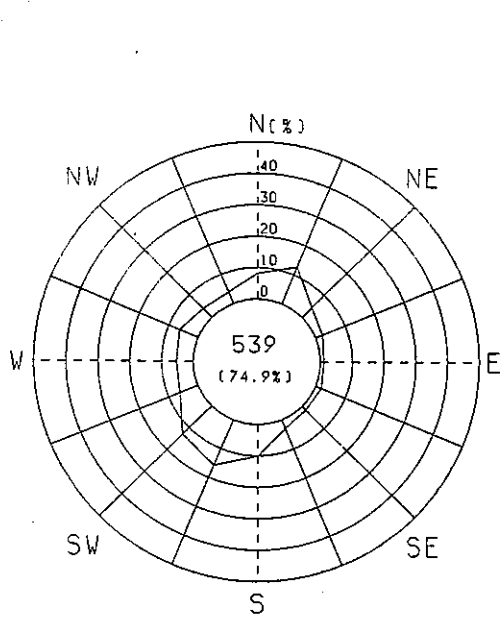

1978/6/1 0:00 - 1978/6/30 23:55

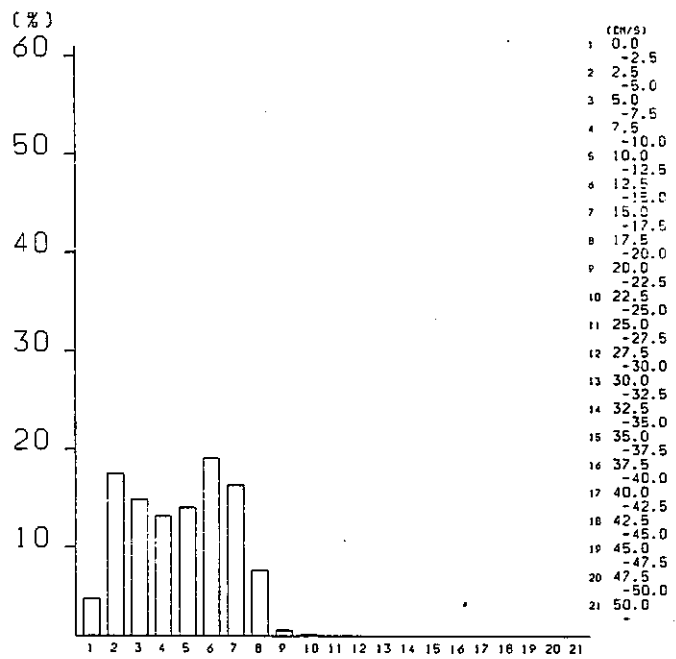
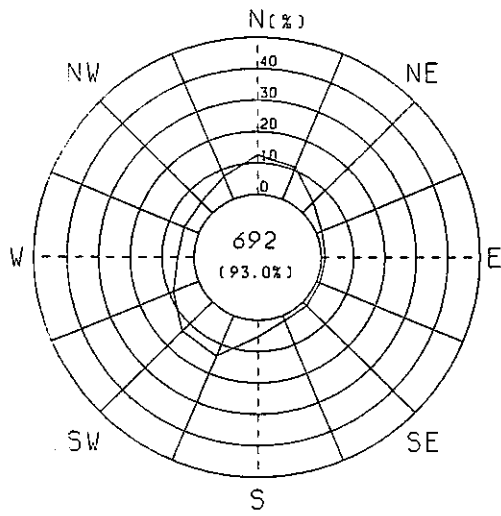

1978/7/1 0:00 - 1978/7/31 23:55

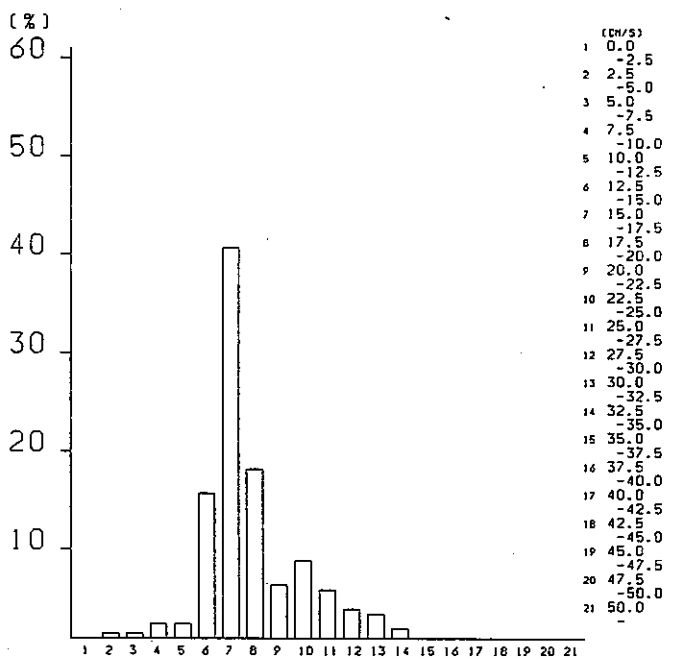
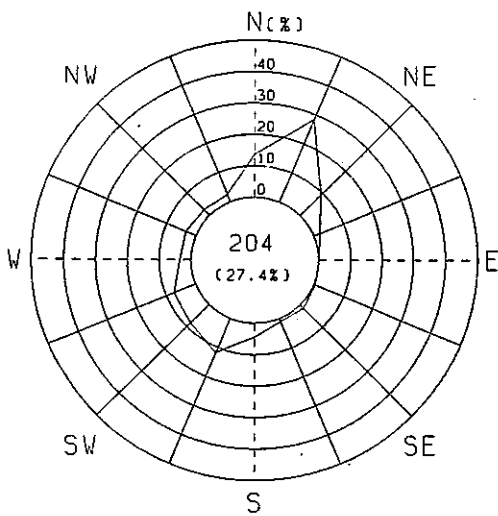

1978/10/1 0:00 - 1978/10/31 23:55

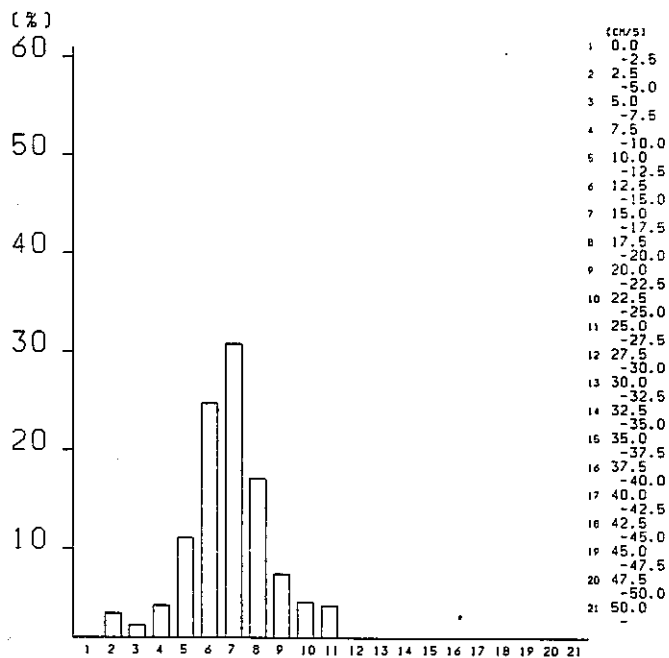
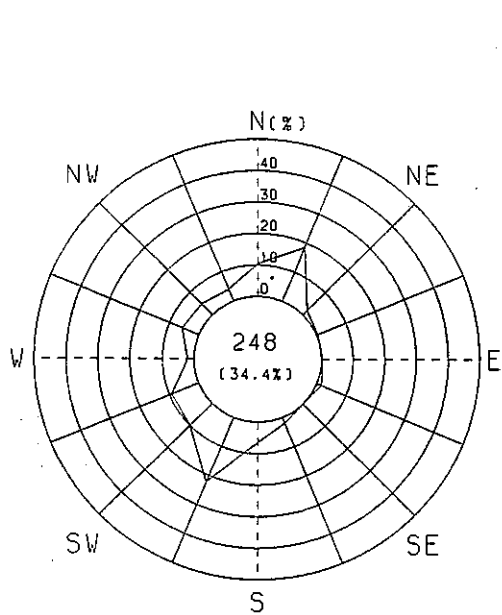

1978/11/1 0:00 - 1978/11/30 23:55

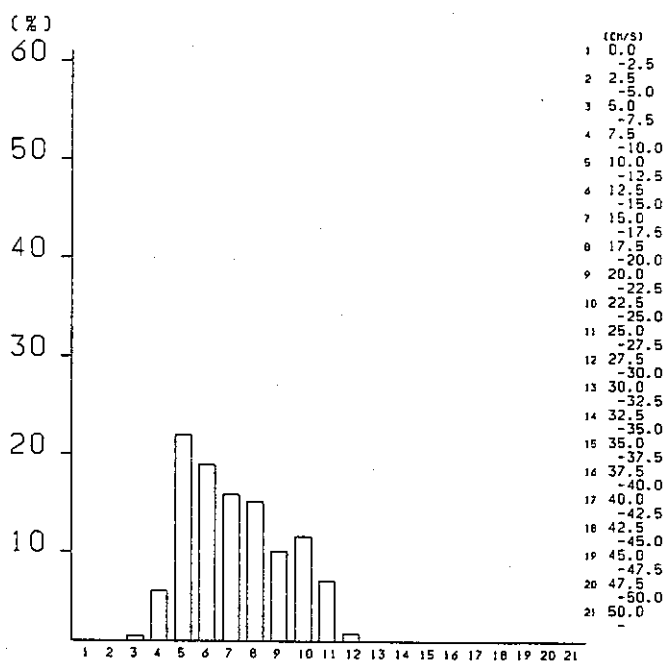
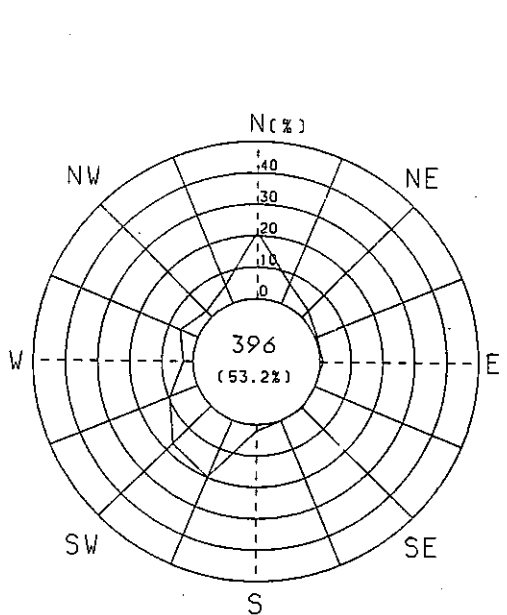

1978/12/1 0:00 - 1978/12/31 23:55

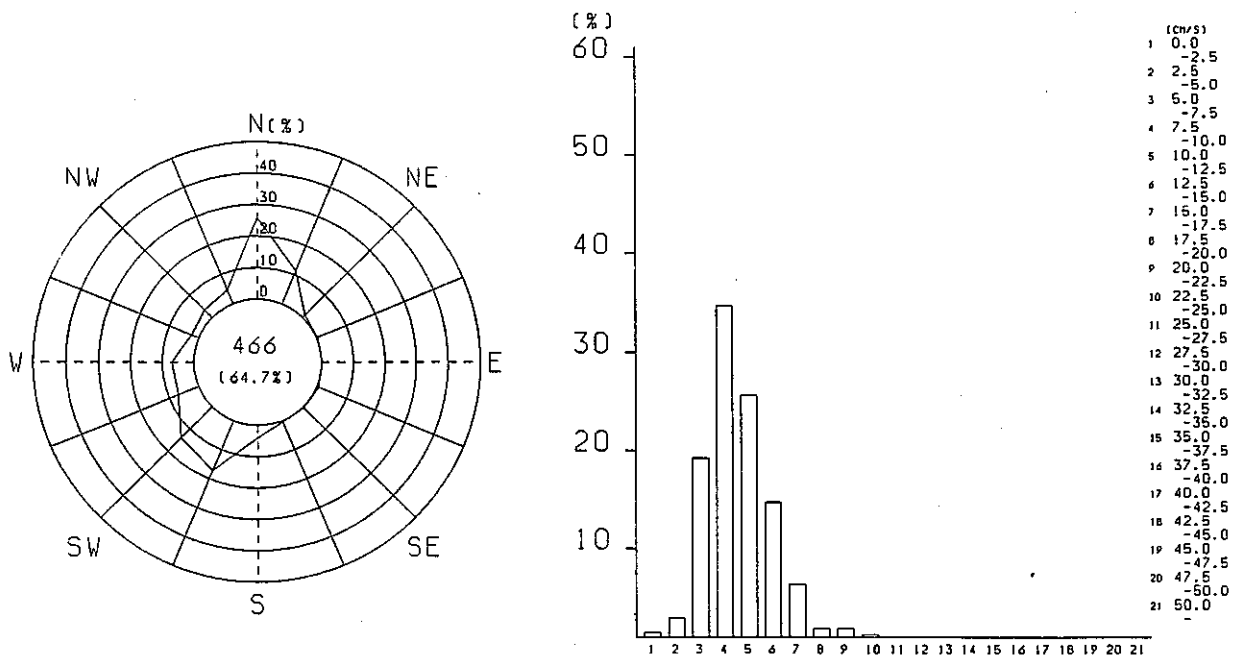

1979/1/2 0:00 - 1979/1/31 23:55

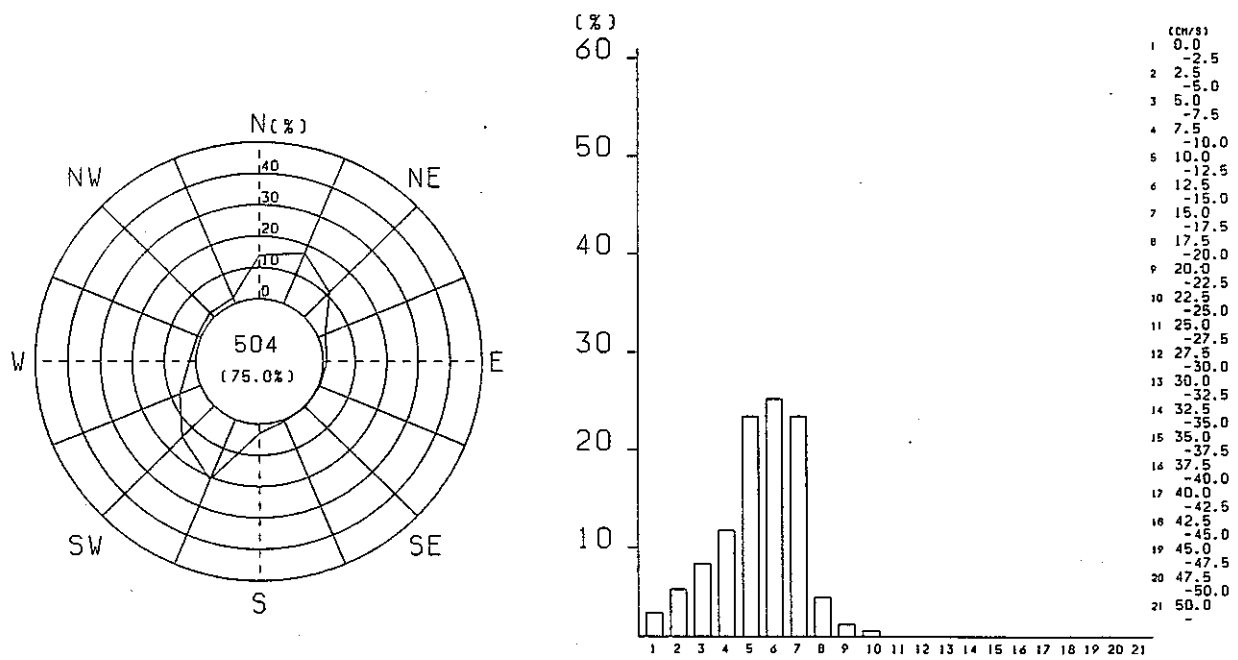

1979/2/1 0:00 - 1979/2/28 23:55

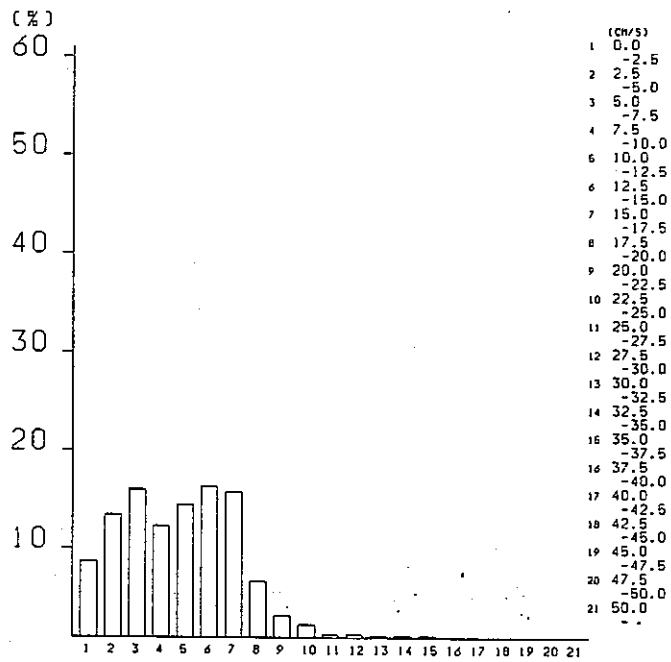
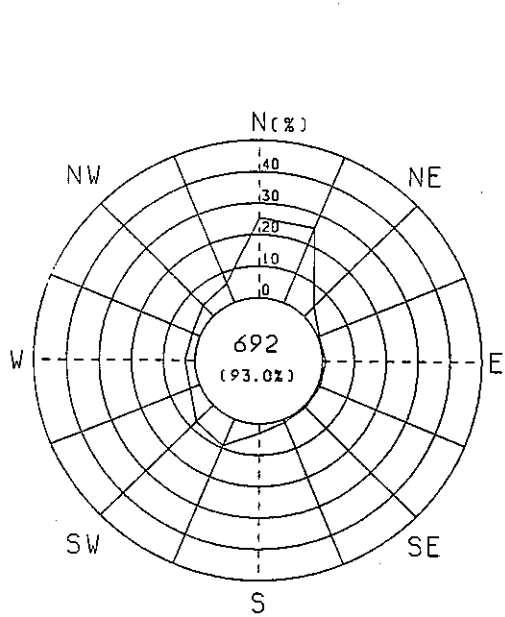

1979/3/1 0:00 - 1979/3/31 23:55

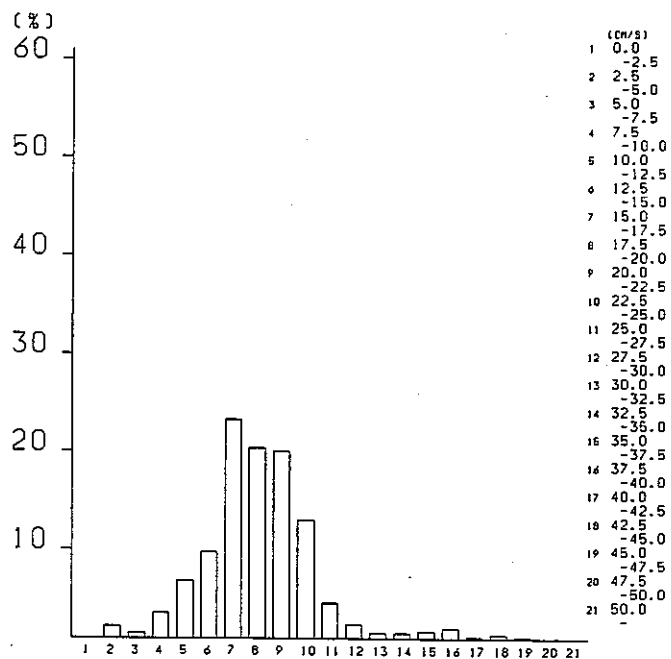
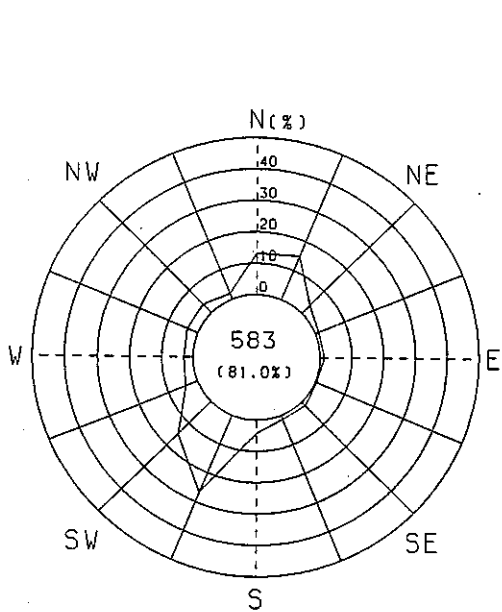

1979/4/1 0:00 - 1979/4/30 23:55

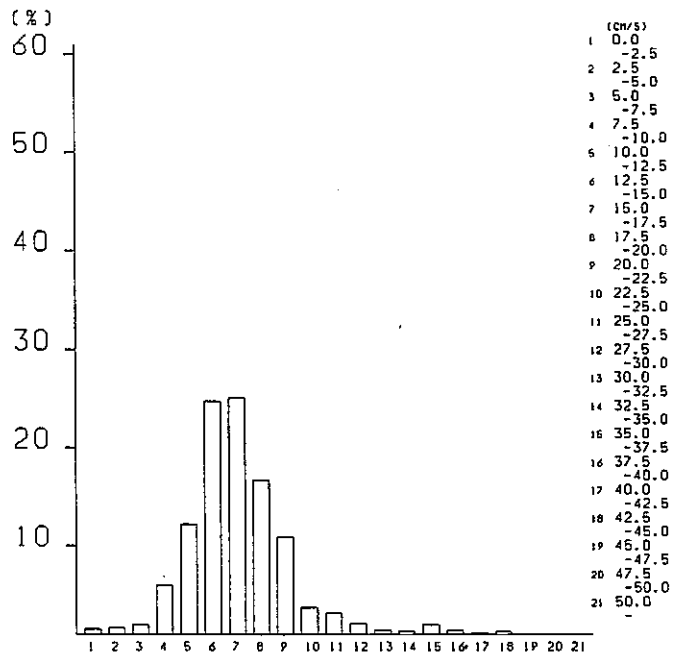
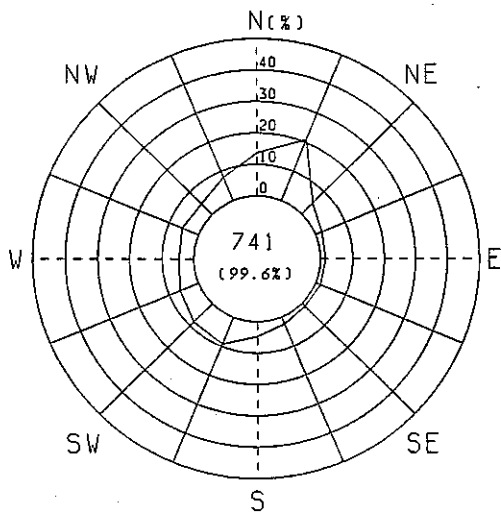

1979/5/1 0:00 - 1979/5/31 23:55

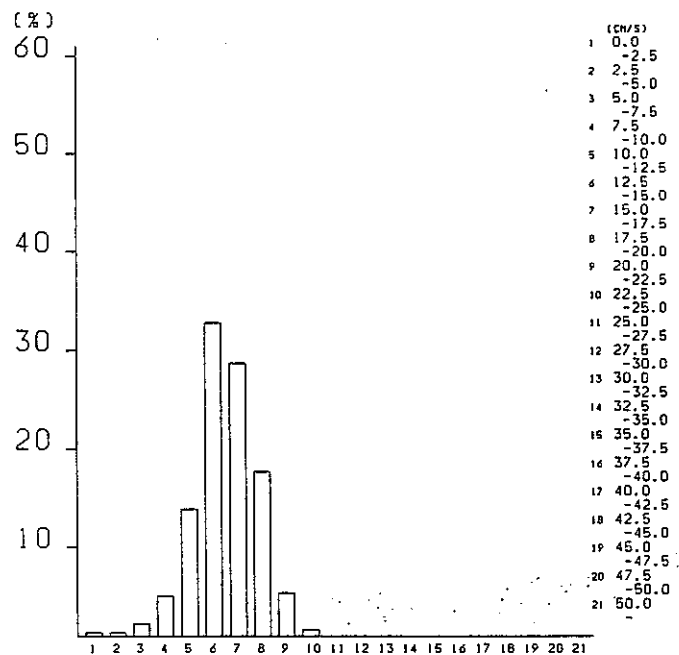
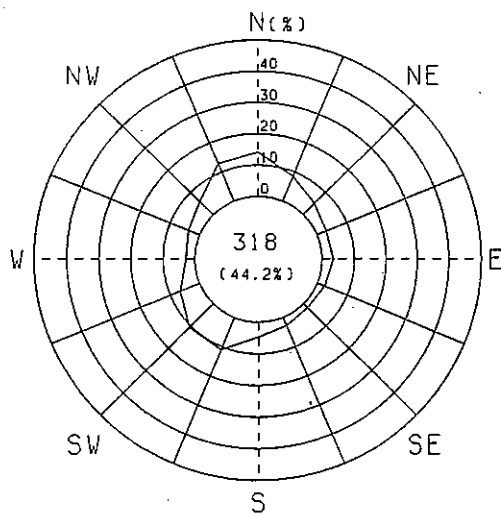

1979/6/1 0:00 - 1979/6/30 23:55

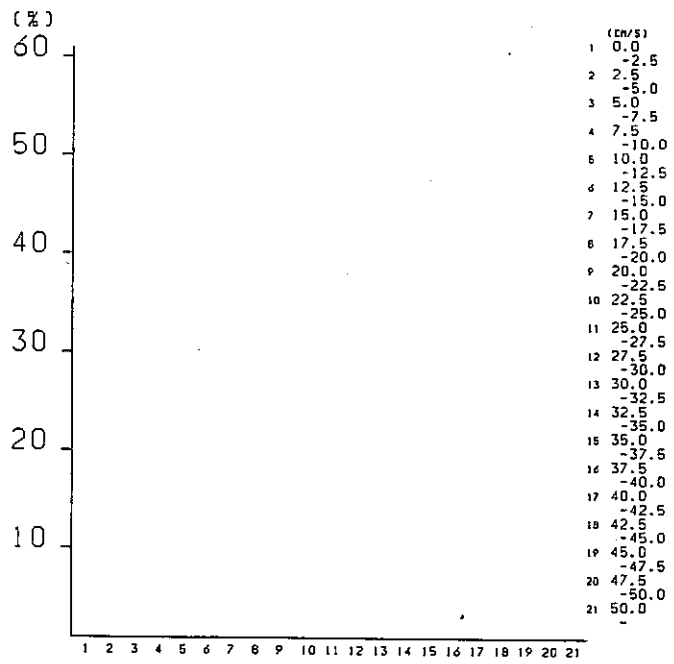
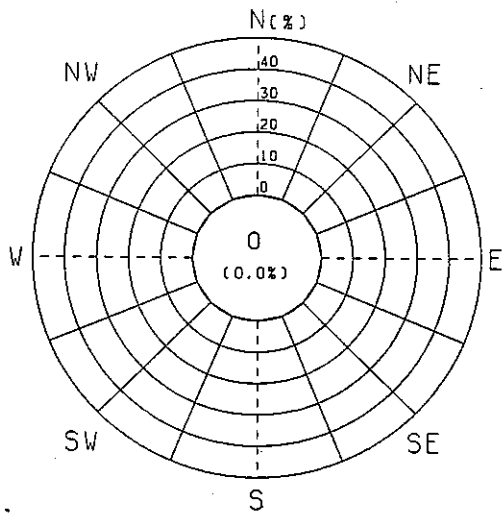

1979/7/1 0:00 - 1979/7/31 23:55

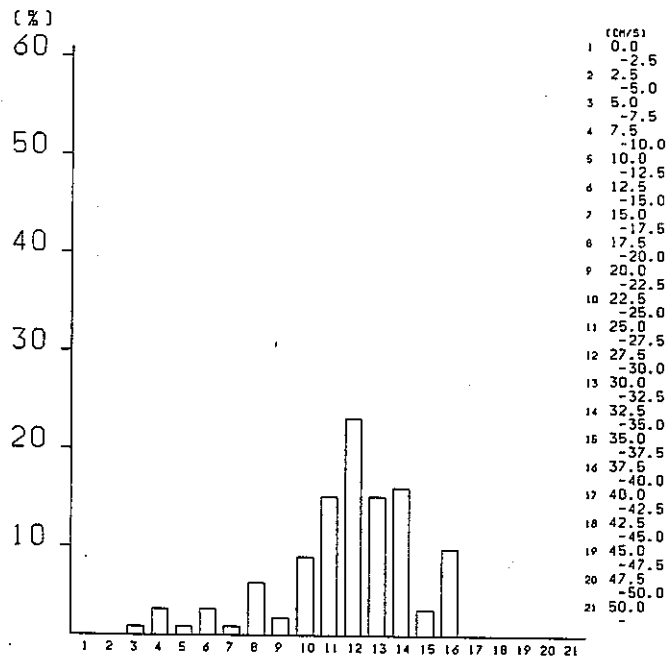
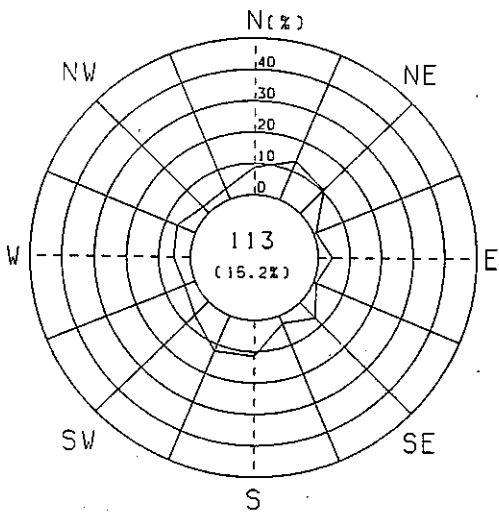

1979/8/1 0:00 - 1979/8/31 23:55

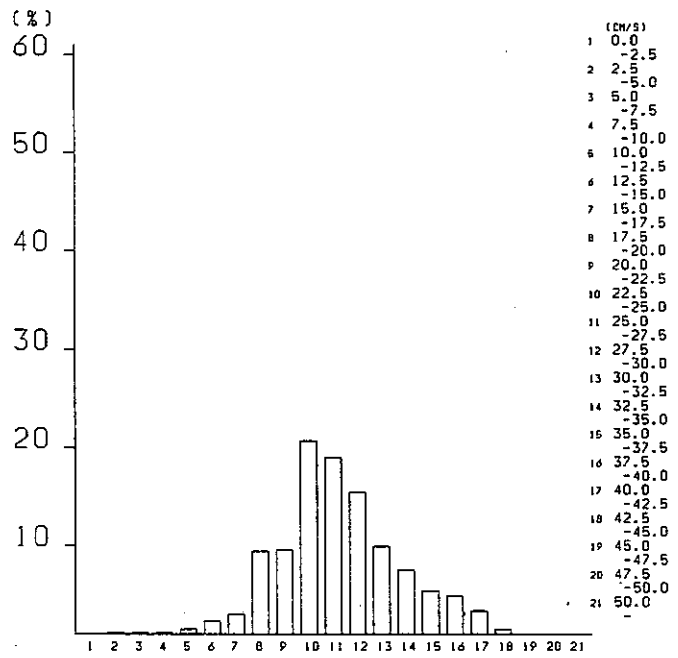
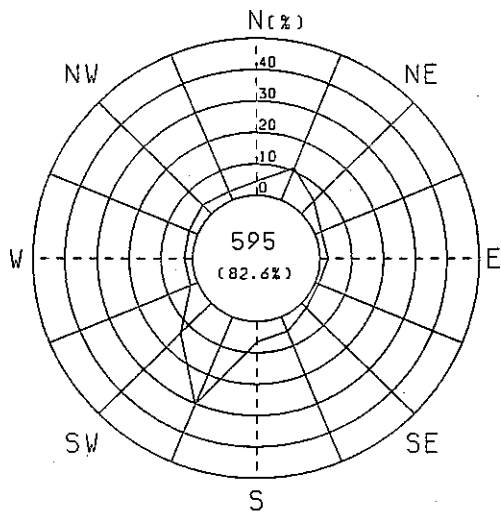

1979/9/1 0:00 - 1979/9/30 23:55

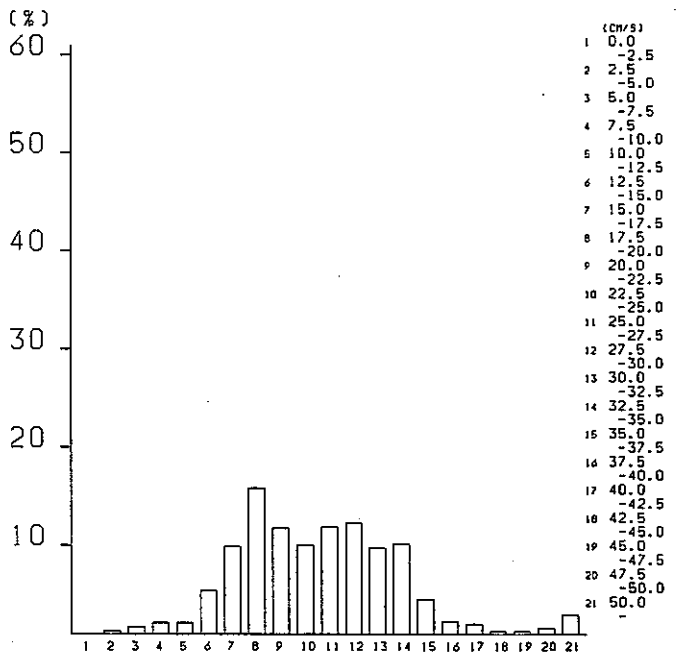
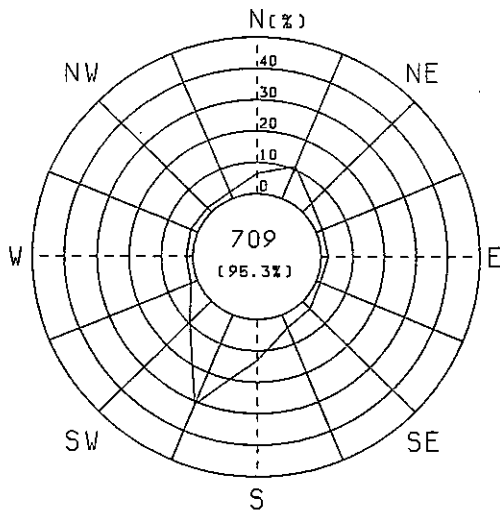

1979/10/1 0:00 - 1979/10/31 23:55

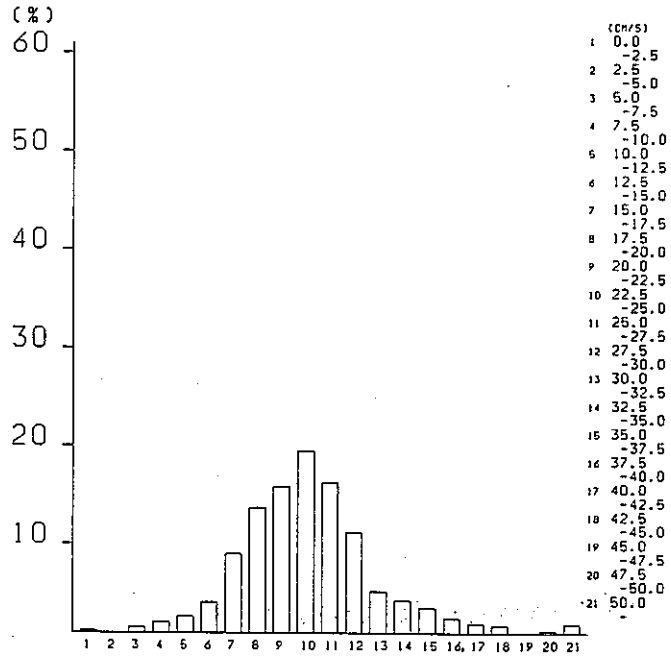
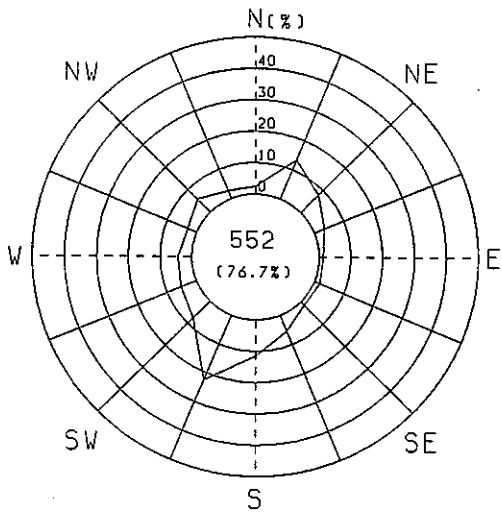

1979/11/1 0:00 - 1979/11/30 23:55

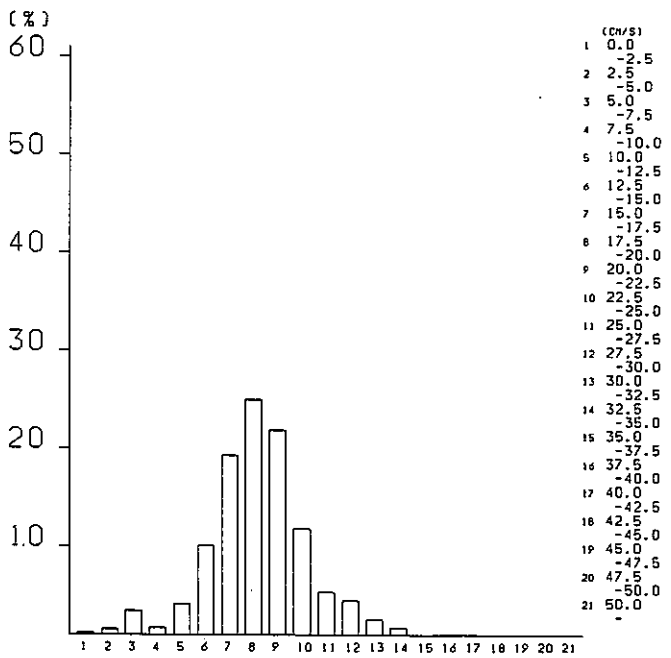
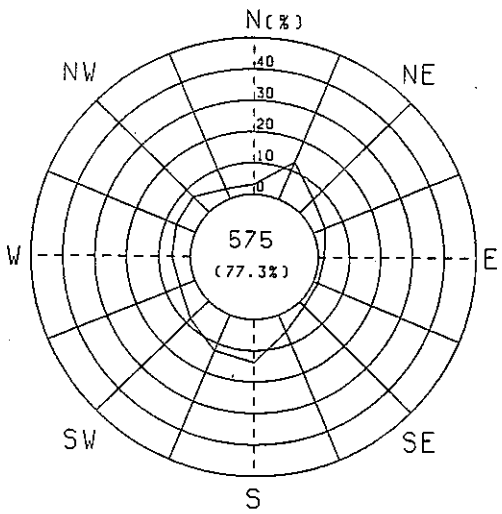

1979/12/1 0:00 - 1979/12/31 23:55

PNC 18420 86-05 (2)

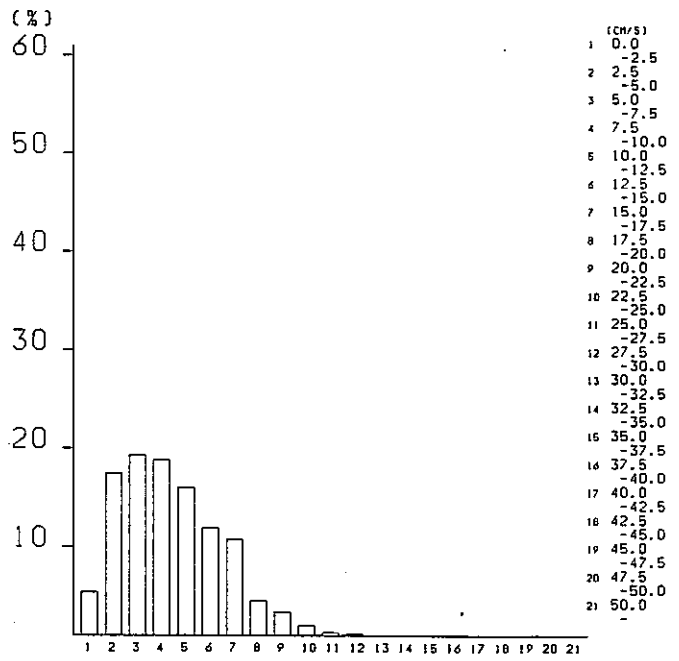
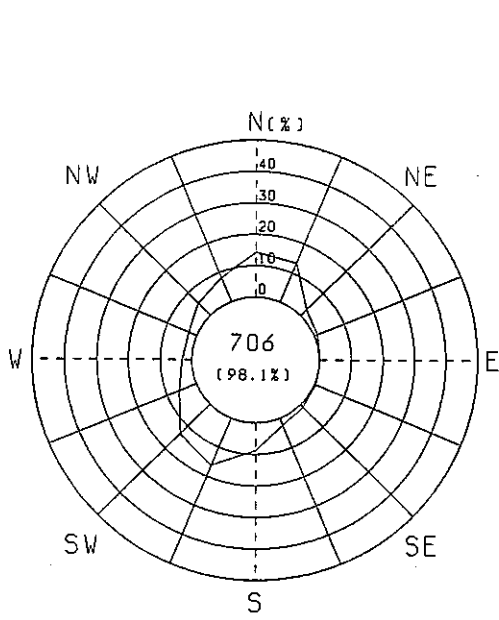

1980/1/2 0:00 - 1980/1/31 23:55

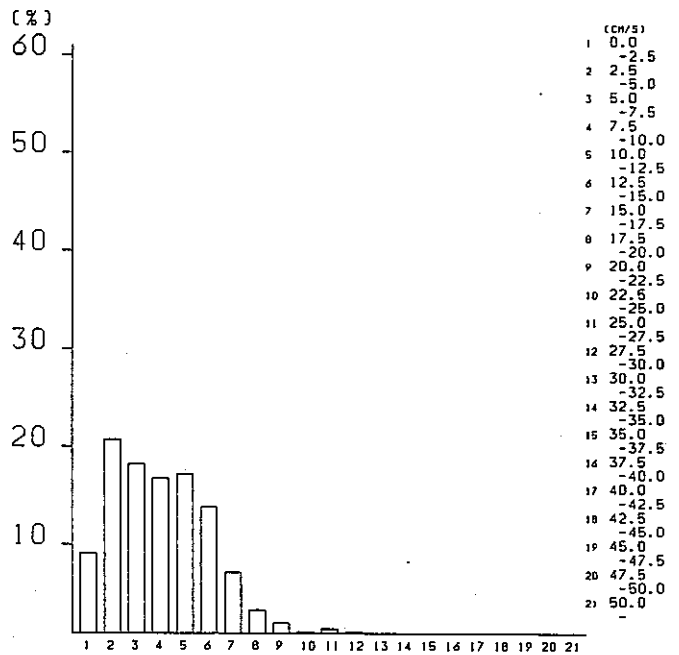
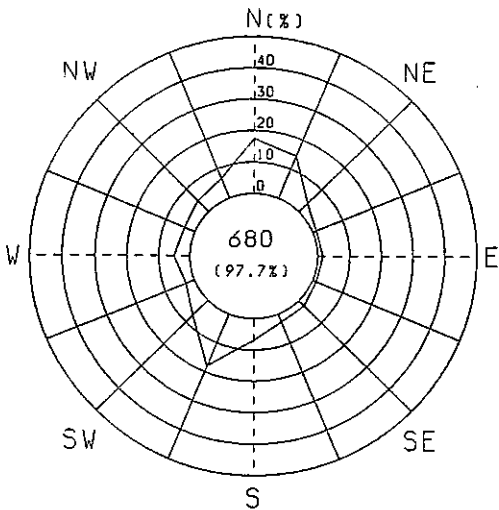

1980/2/1 0:00 - 1980/2/29 23:55

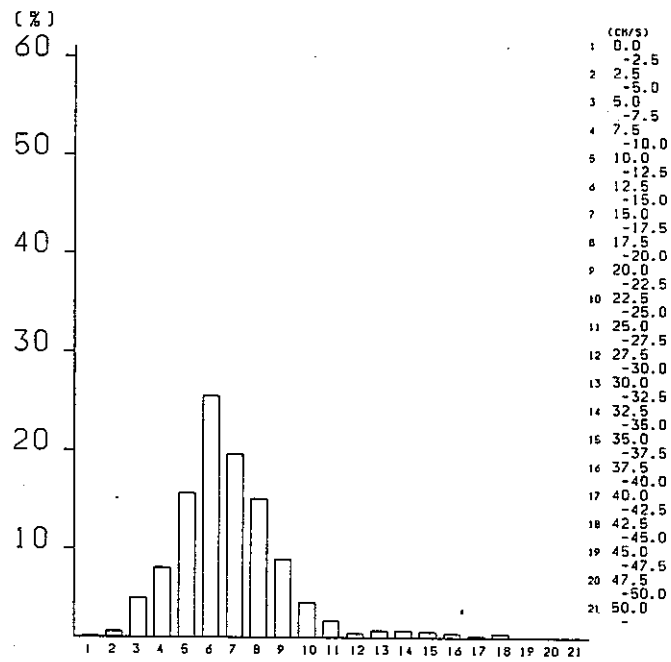
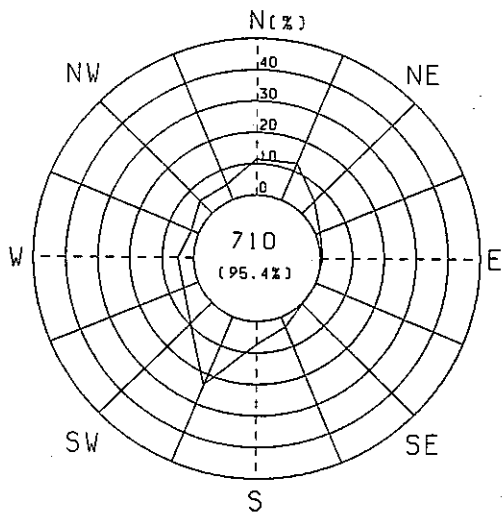

1980/3/1 0:00 - 1980/3/31 23:55

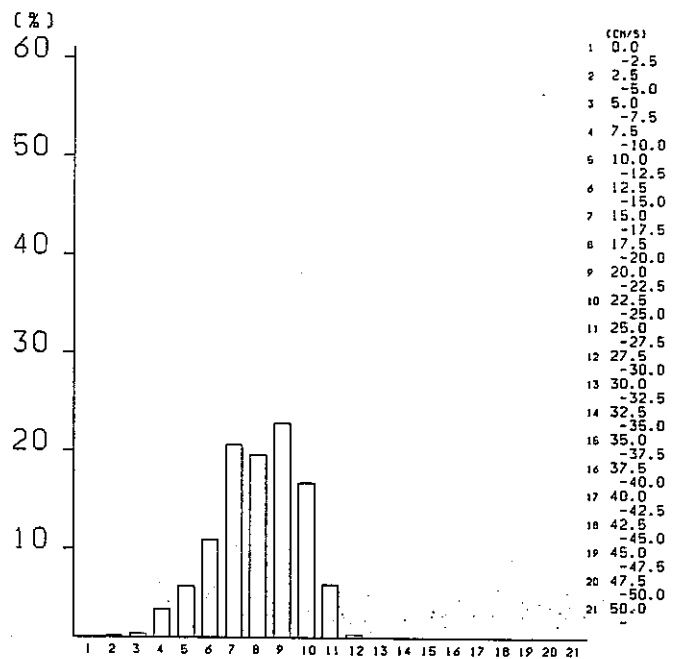
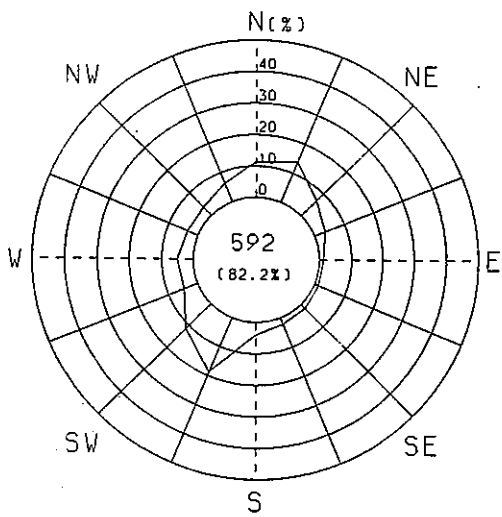

1980/4/1 0:00 - 1980/4/30 23:55

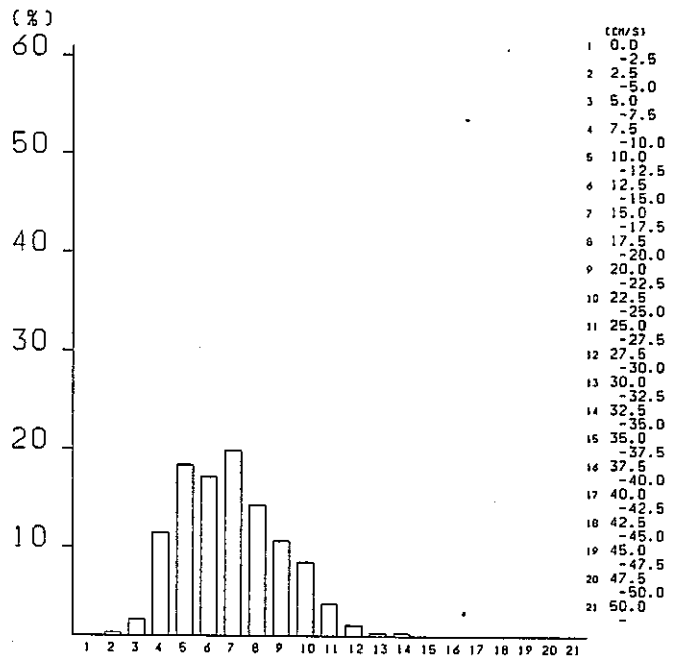
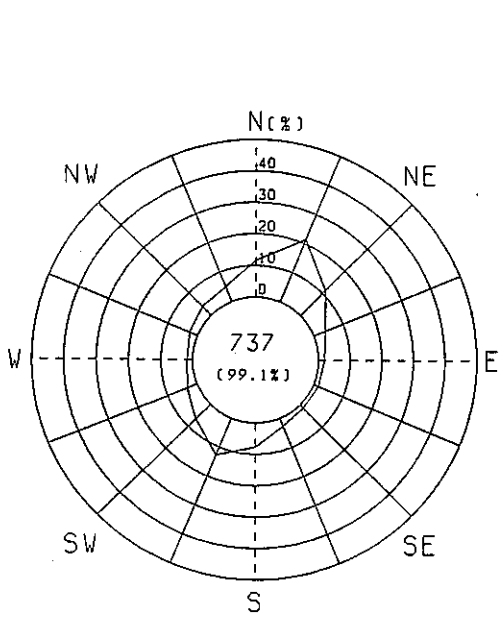

1980/5/1 0:00 - 1980/5/31 23:55

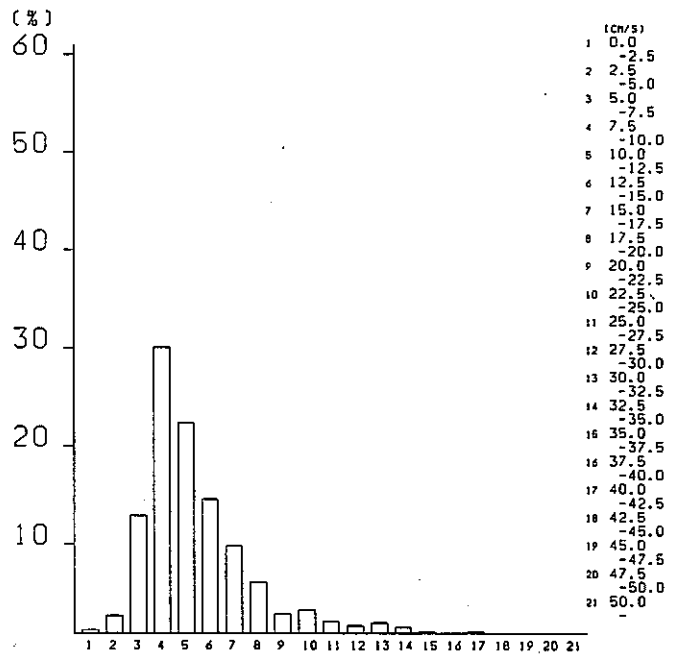
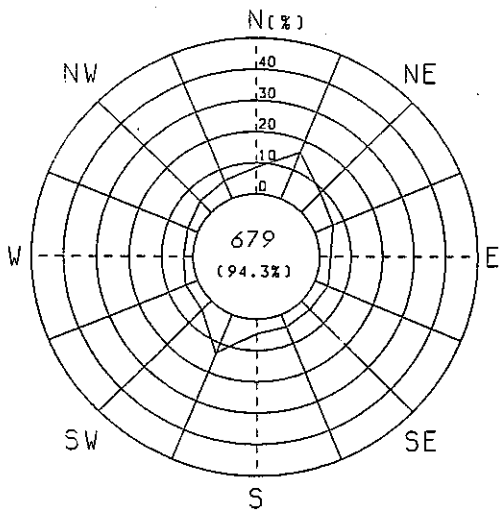

1980/6/1 0:00 - 1980/6/30 23:55

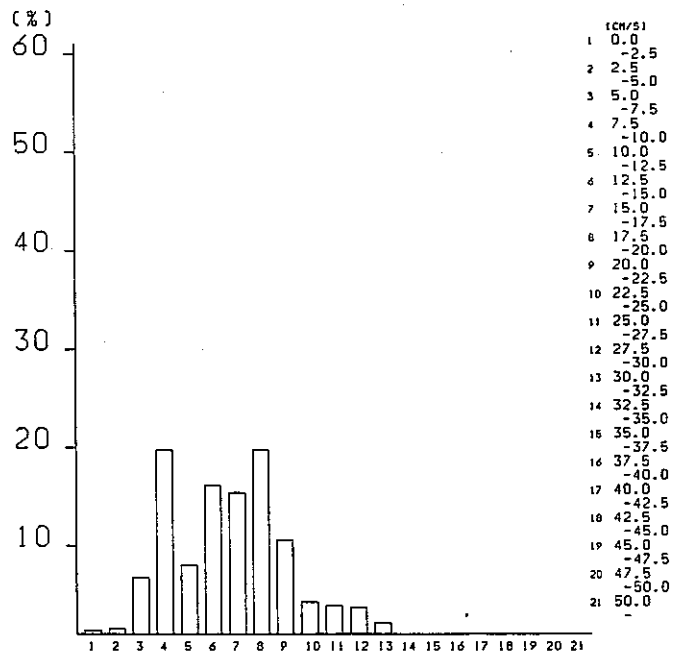
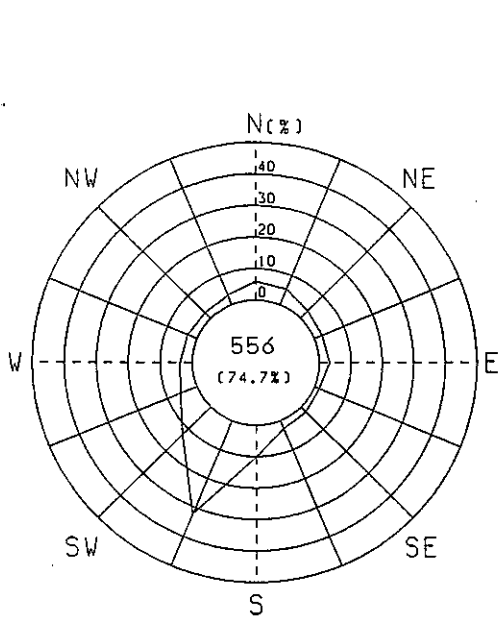

1980/7/1 0:00 - 1980/7/31 23:55

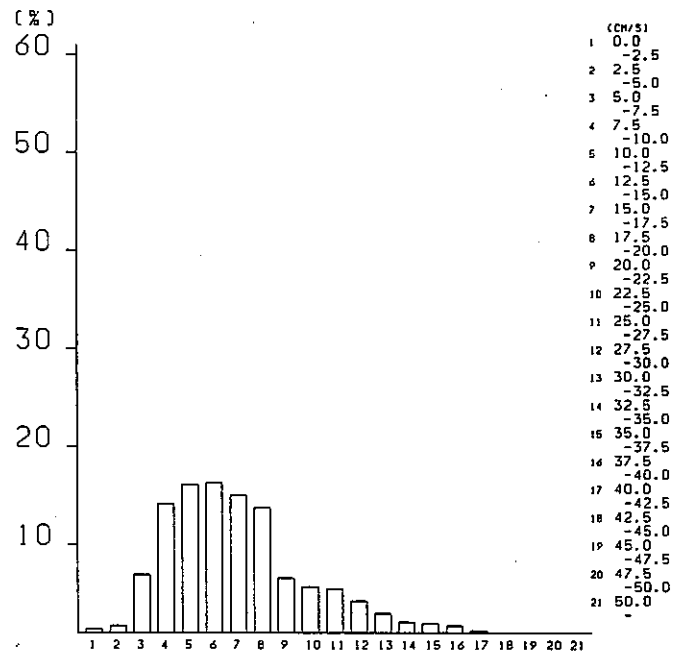
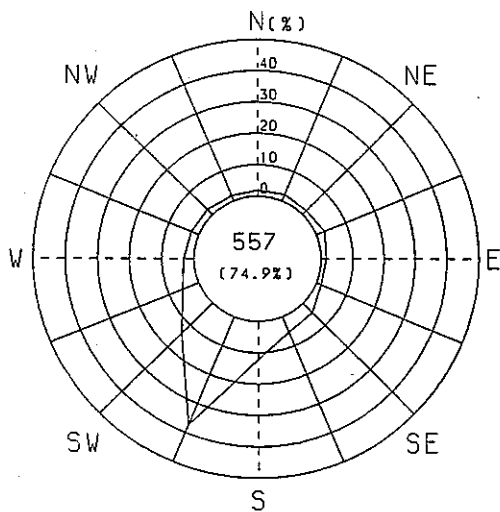

1980/8/1 0:00 - 1980/8/31 23:55

1-LAYER (-3M) MEAN

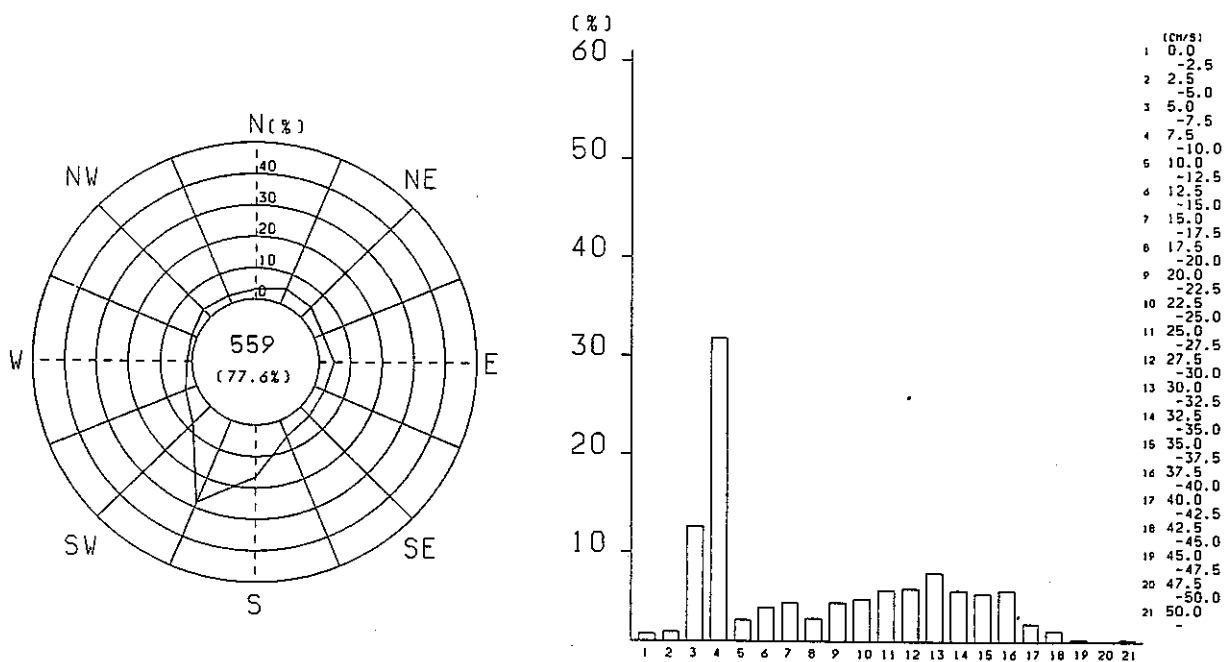

1980/9/1 0:00 - 1980/9/30 23:55

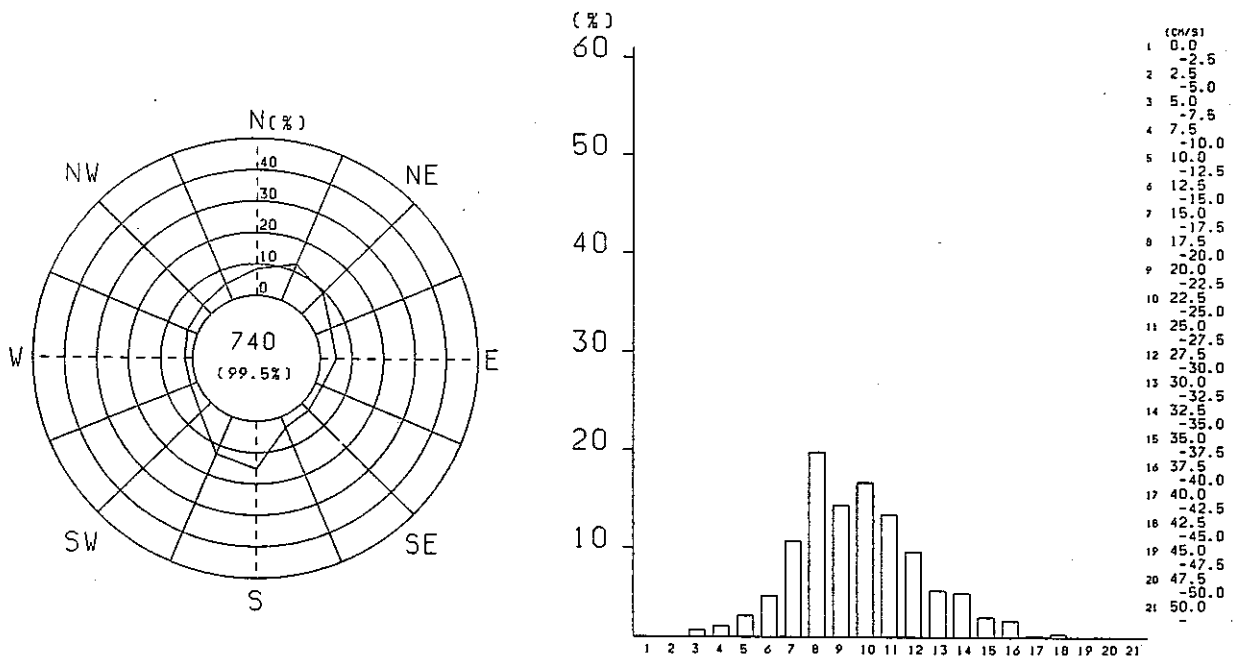

1980/10/1 0:00 - 1980/10/31 23:55

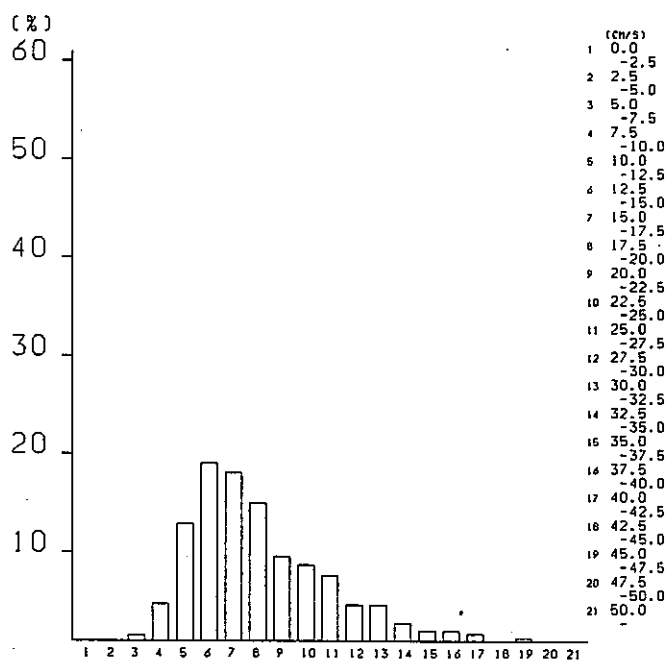
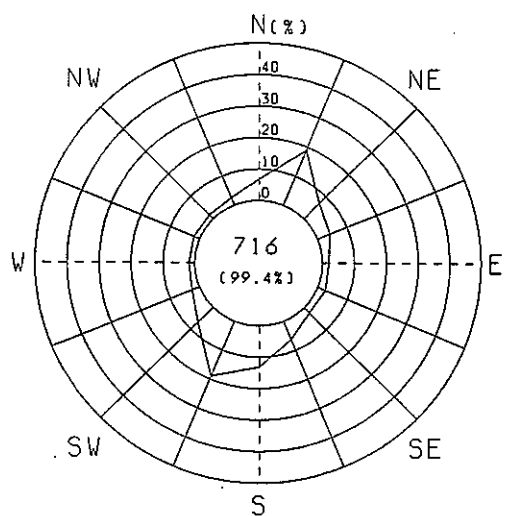

1980/11/1 0:00 - 1980/11/30 23:55

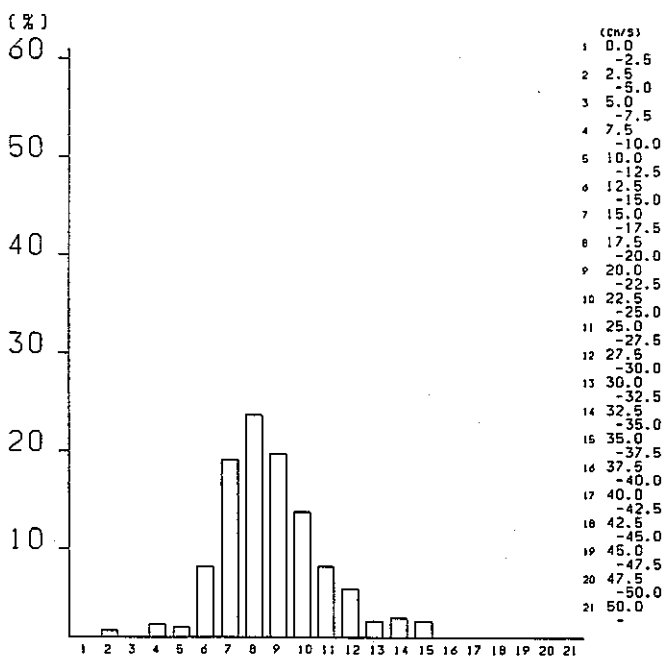
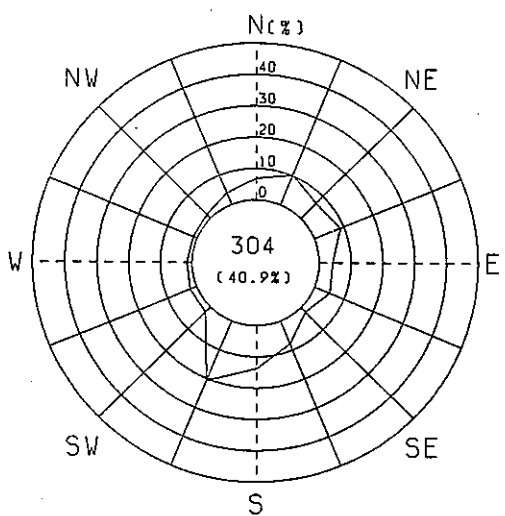

1980/12/1 0:00 - 1980/12/31 23:55

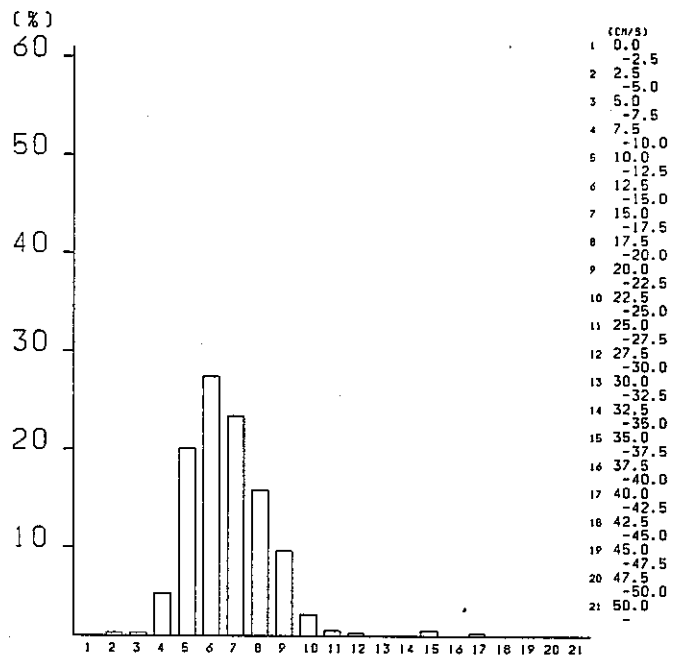
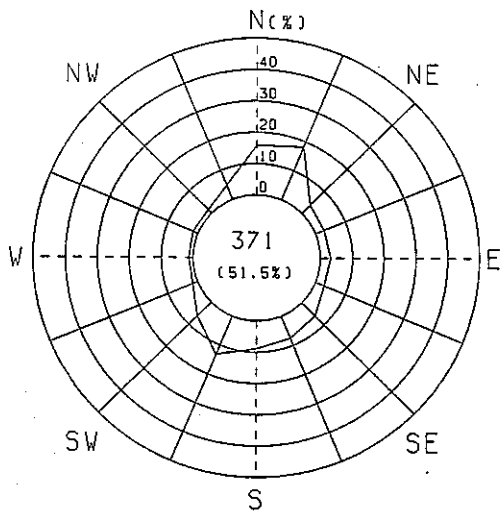

1981/1/2 0:00 - 1981/1/31 23:55

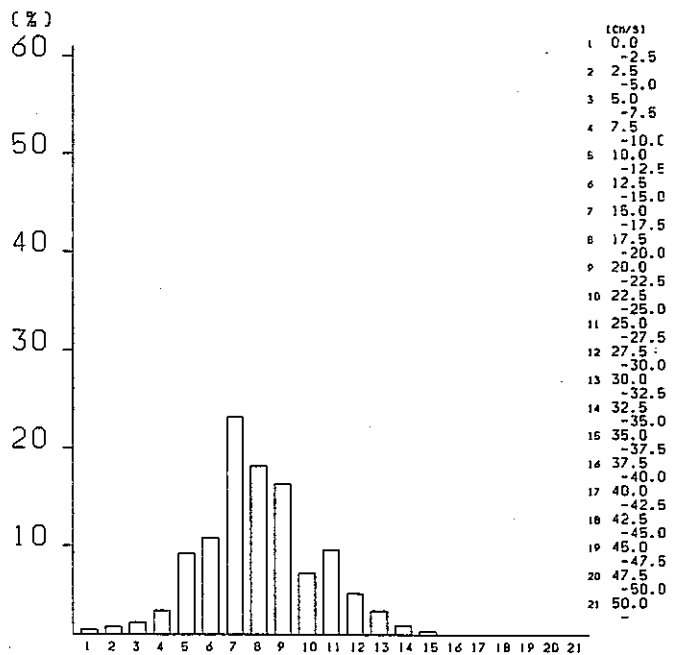
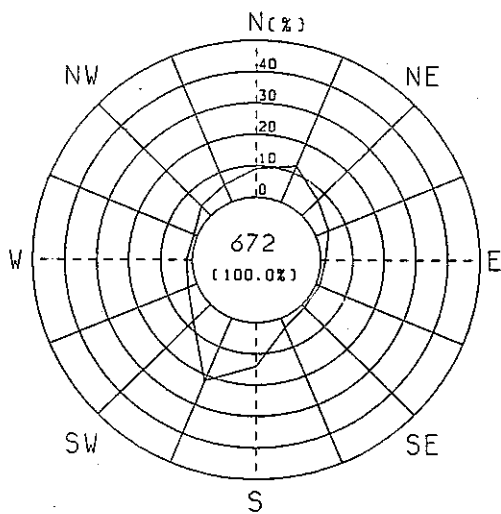

1981/2/1 0:00 - 1981/2/28 23:55

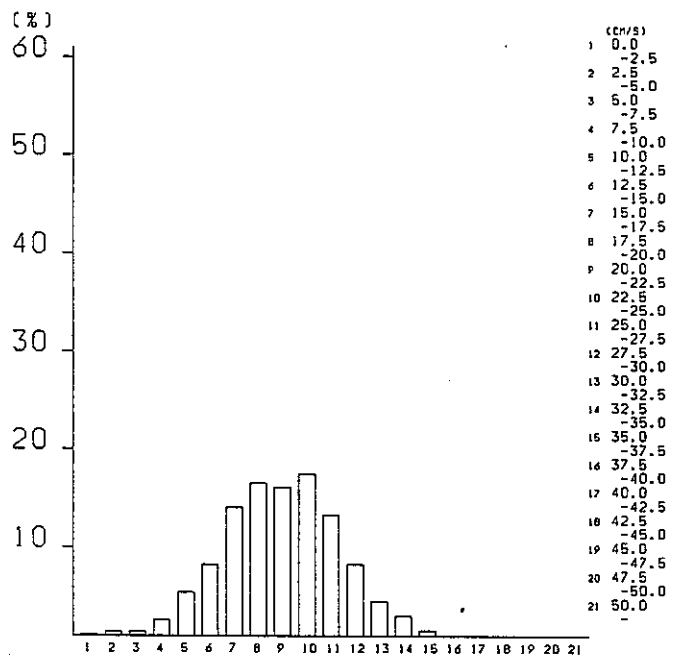
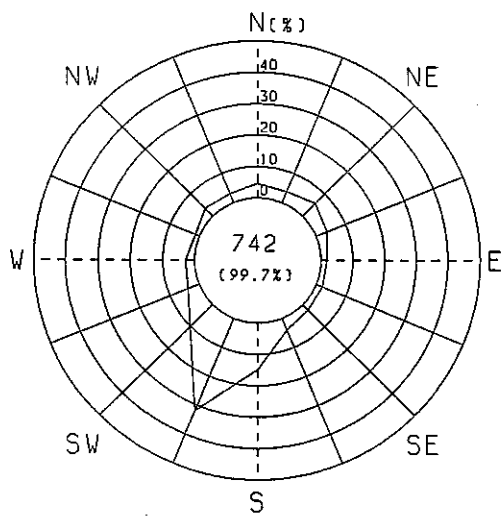

1981/3/1 0:00 - 1981/3/31 23:55

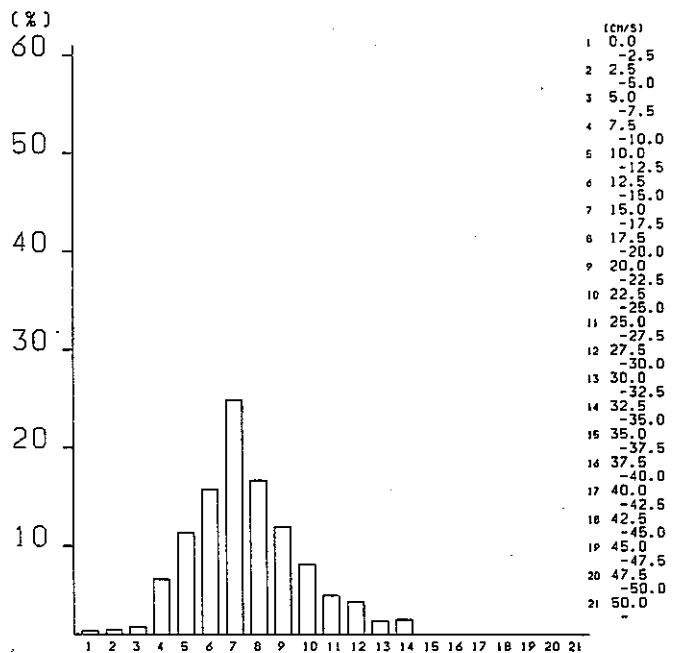
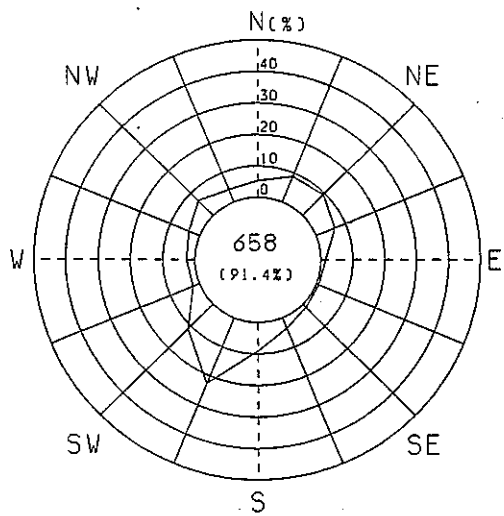

1981/4/1 0:00 - 1981/4/30 23:55

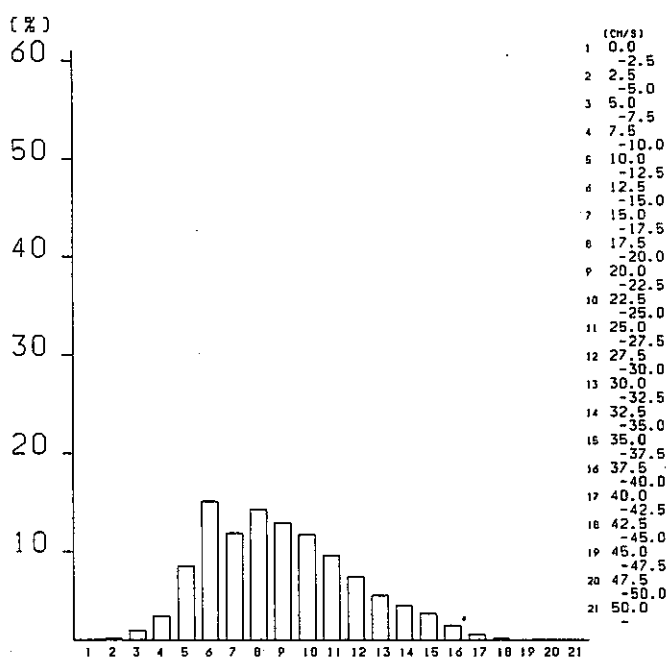
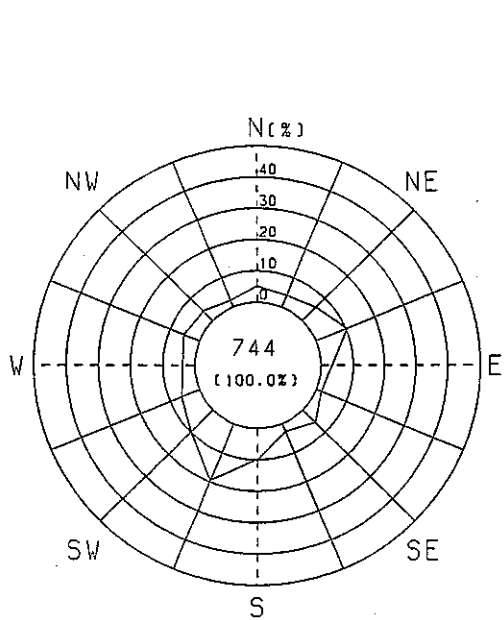

1981/5/1 0:00 - 1981/5/31 23:55

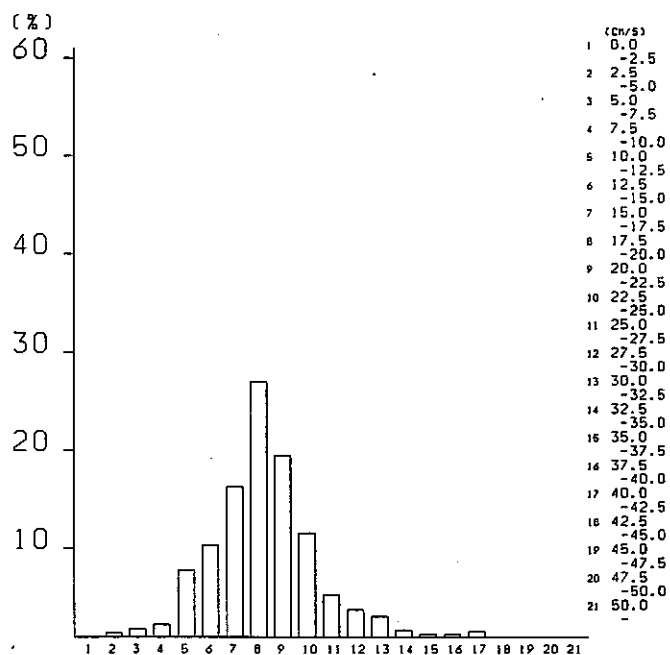
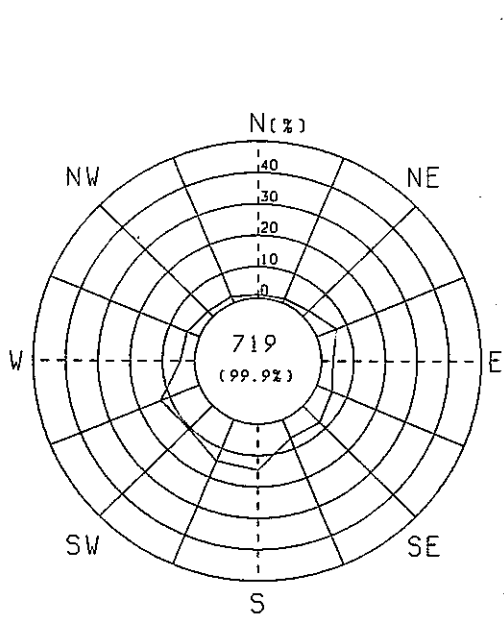

1981/6/1 0:00 - 1981/6/30 23:55

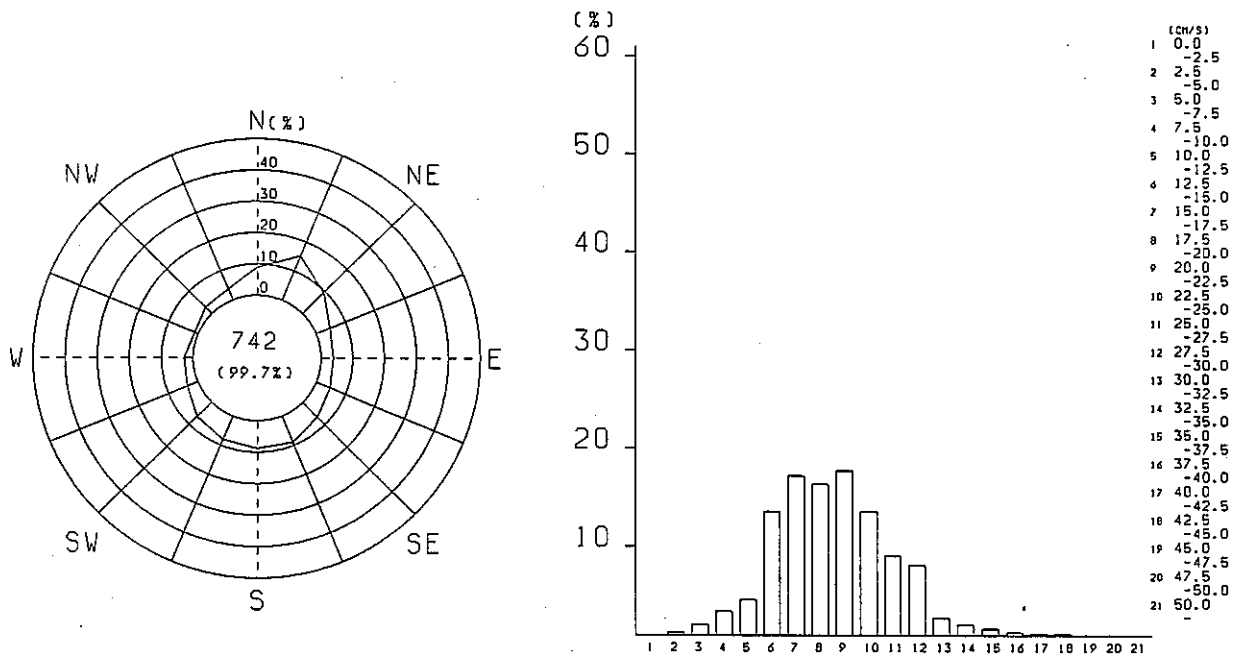

1981/7/1 0:00 - 1981/7/31 23:55

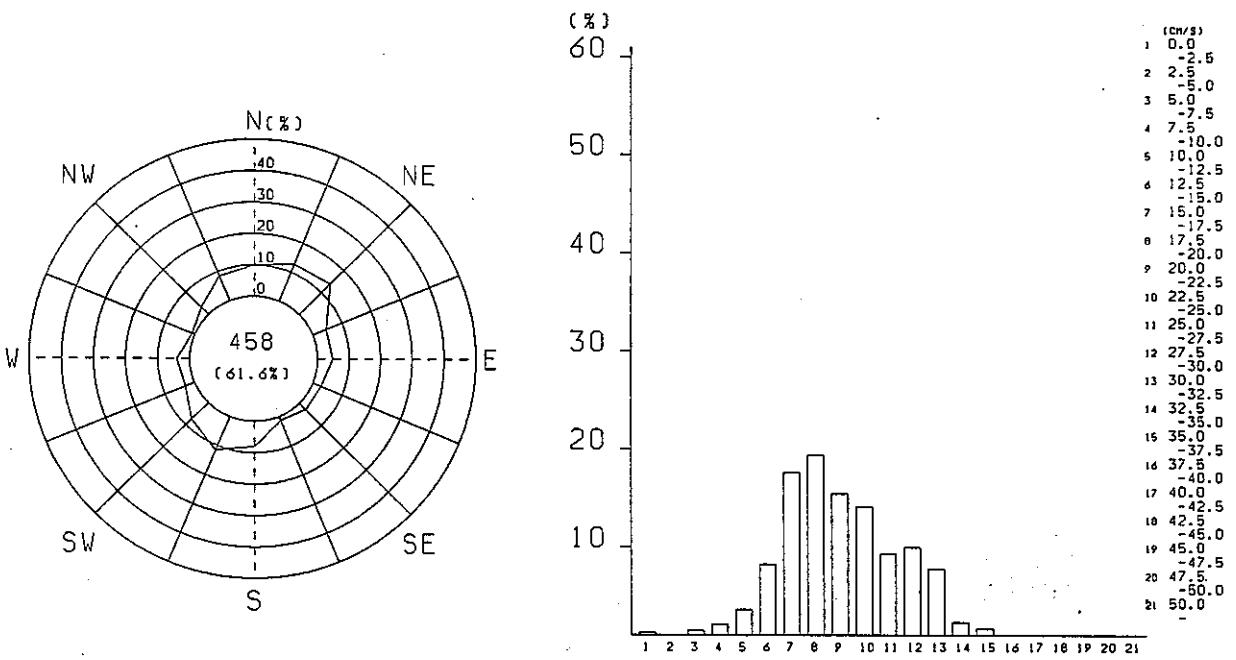

1981/8/1 0:00 - 1981/8/31 23:55

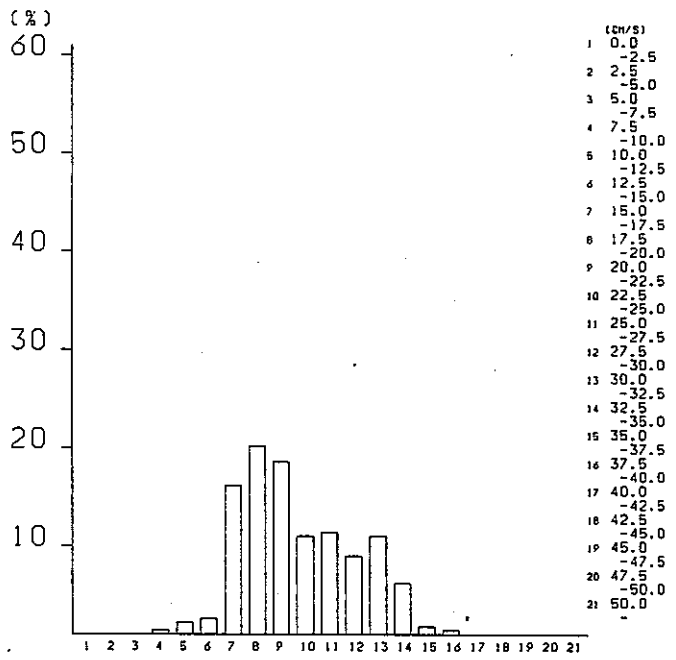
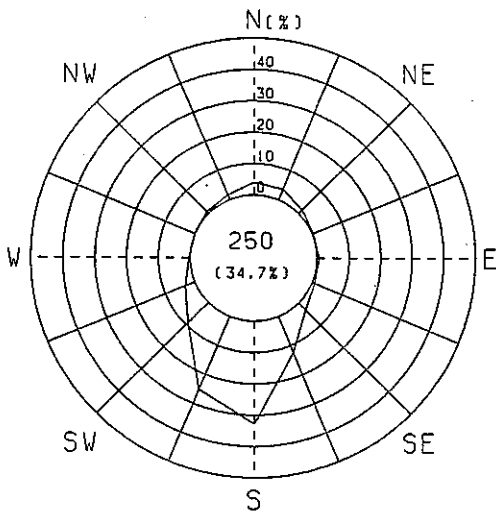

1981/9/1 0:00 - 1981/9/30 23:55

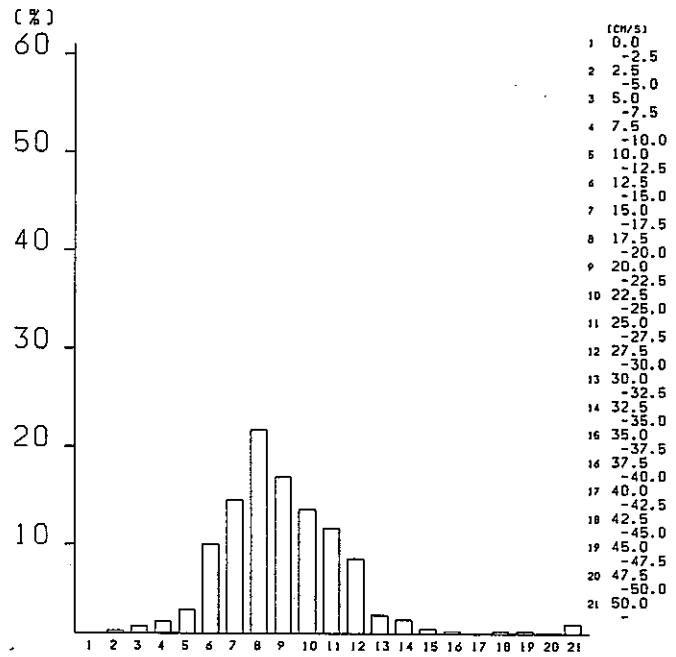
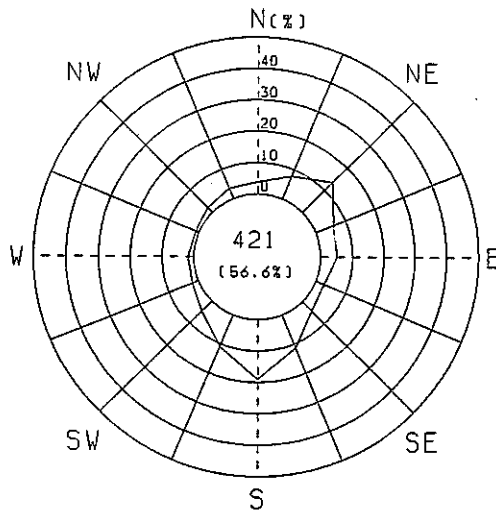

1981/10/1 0:00 - 1981/10/31 23:55

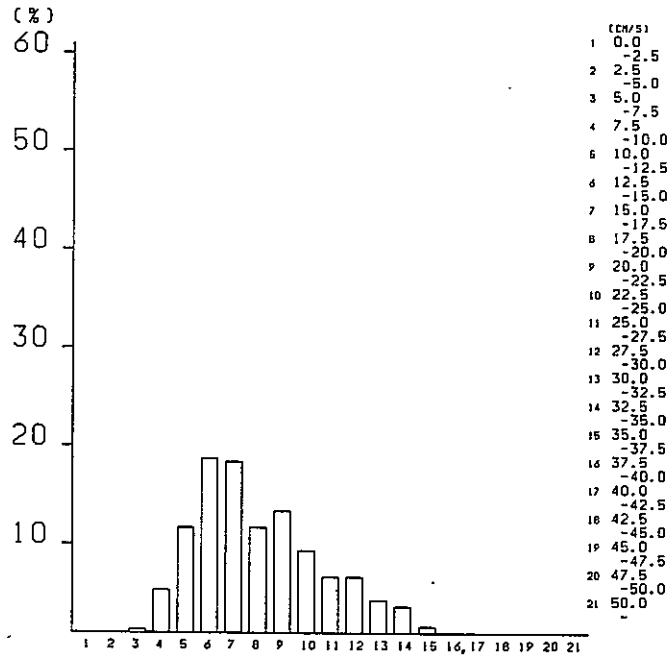
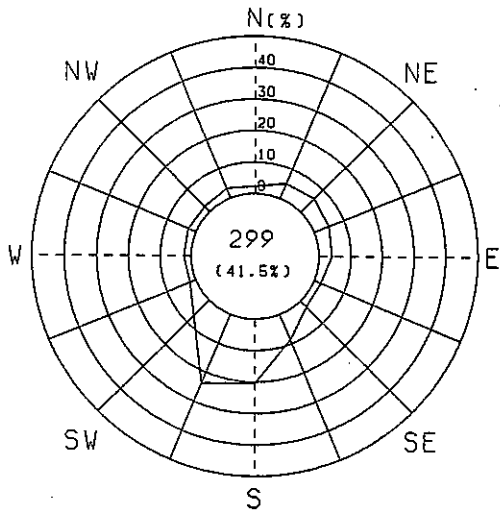

1981/11/1 0:00 - 1981/11/30 23:55

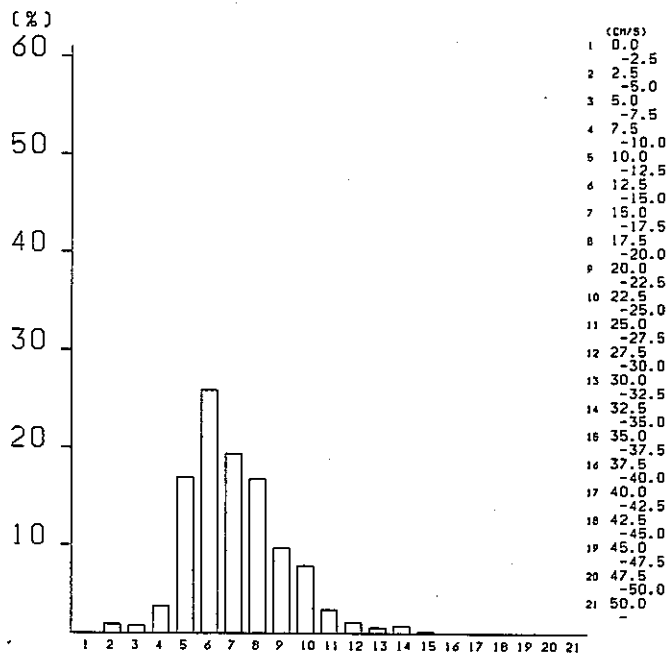
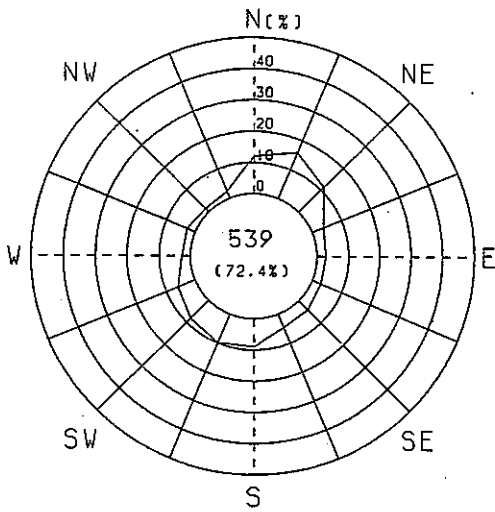

1981/12/1 0:00 - 1981/12/31 23:55

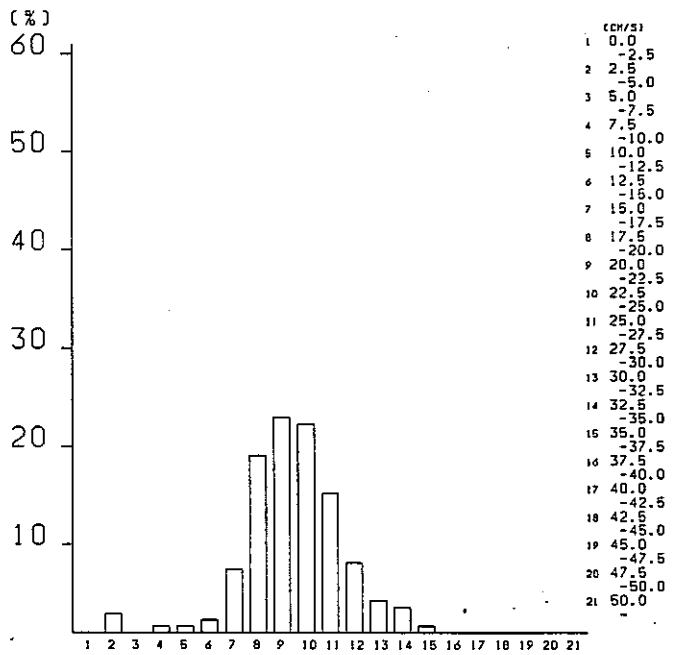
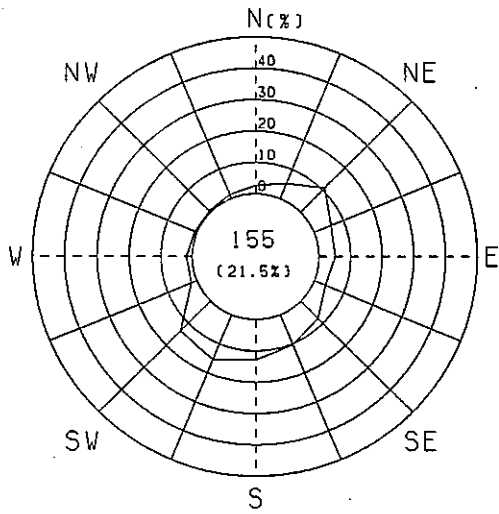

1982/1/2 0:00 - 1982/1/31 23:55

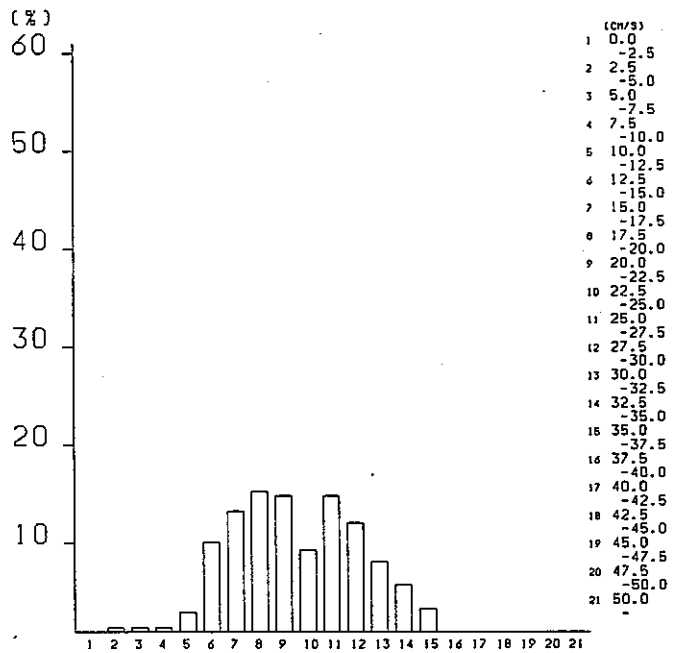
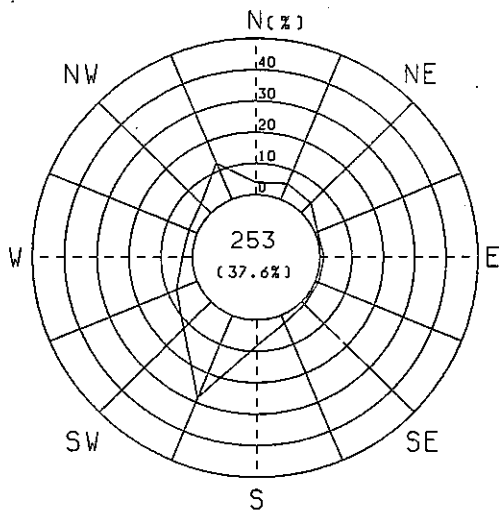

1982/2/1 0:00 - 1982/2/28 23:55

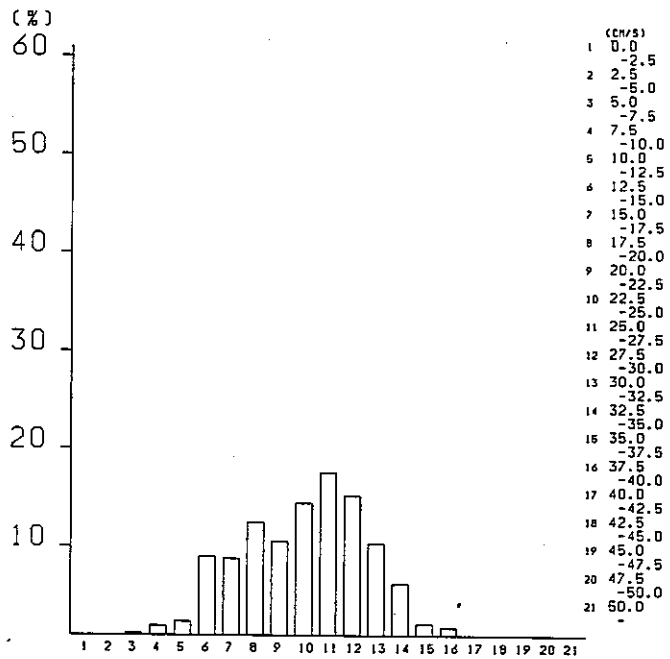
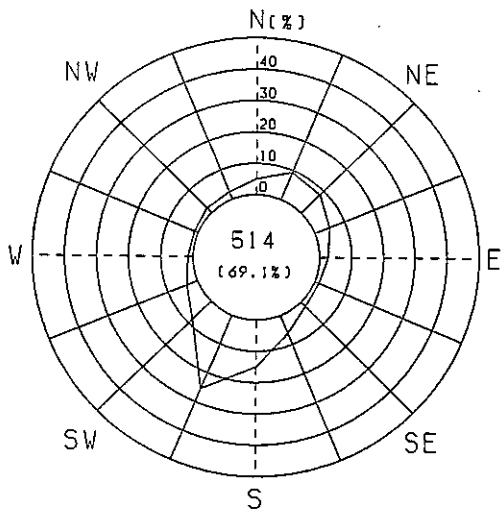

1982/3/1 0:00 - 1982/3/31 23:55

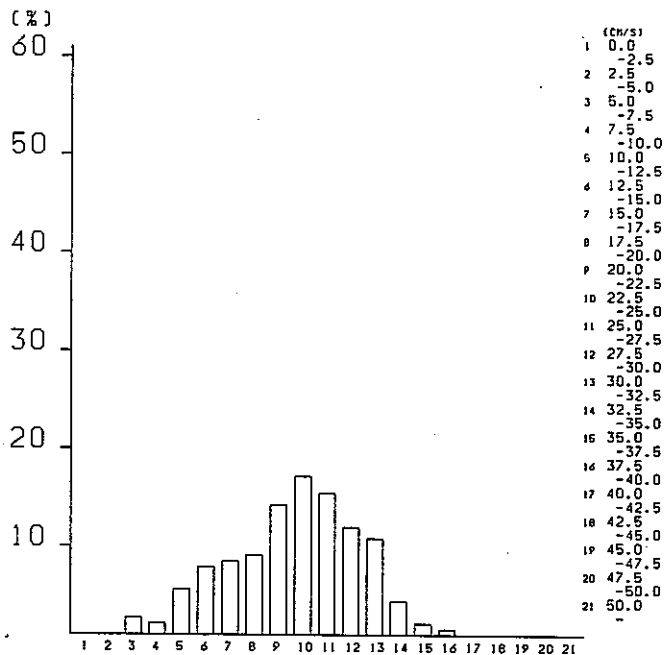
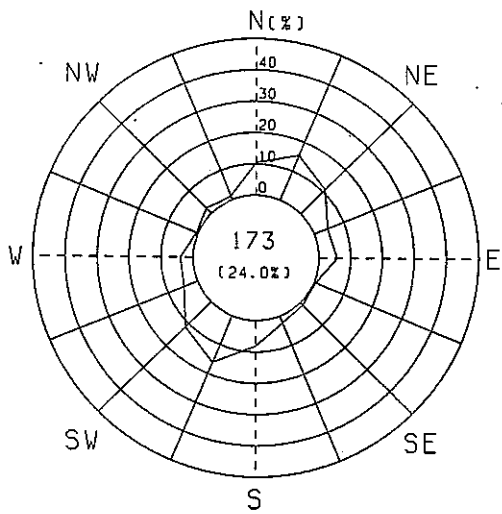

1982/4/1 0:00 - 1982/4/30 23:55

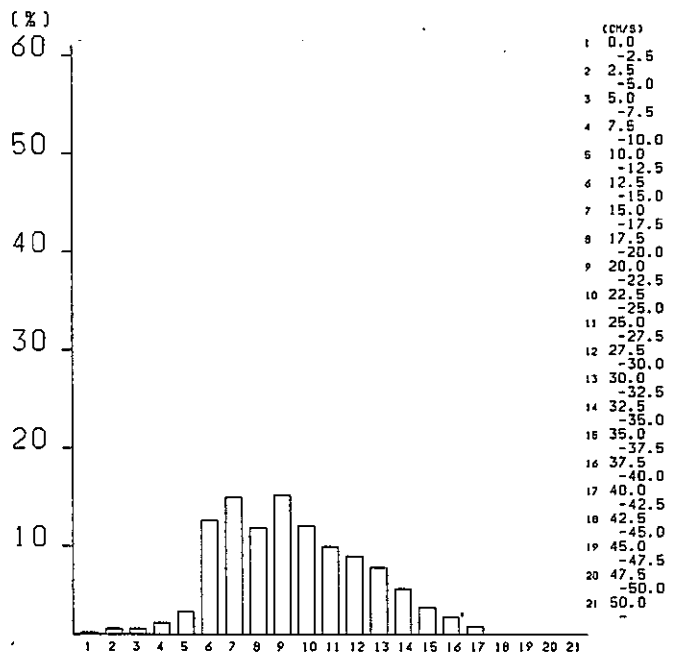
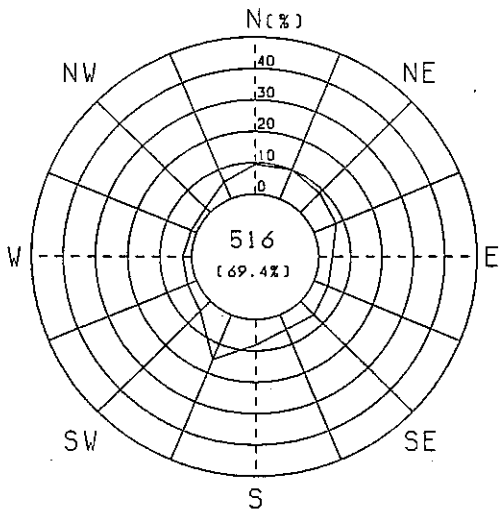

1982/5/1 0:00 - 1982/5/31 23:55

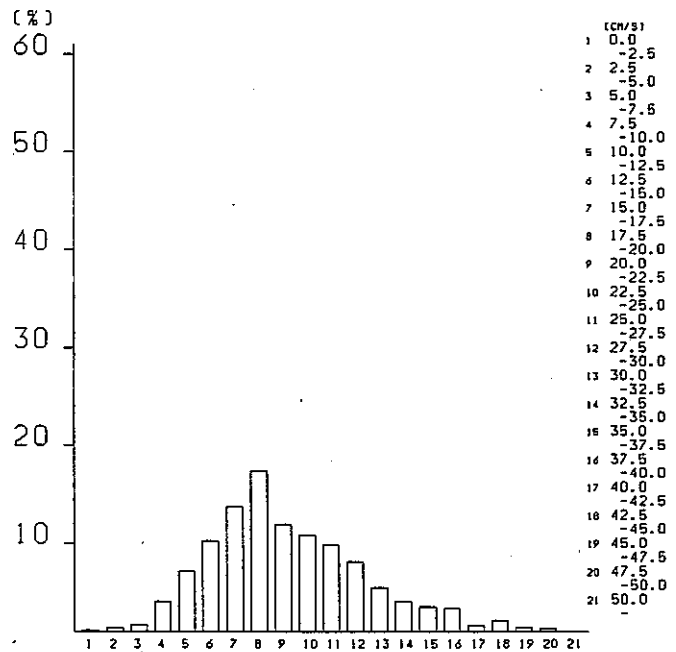
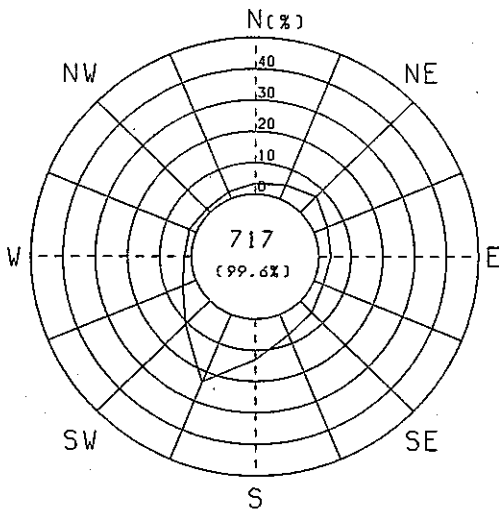

1982/6/1 0:00 - 1982/6/30 23:55

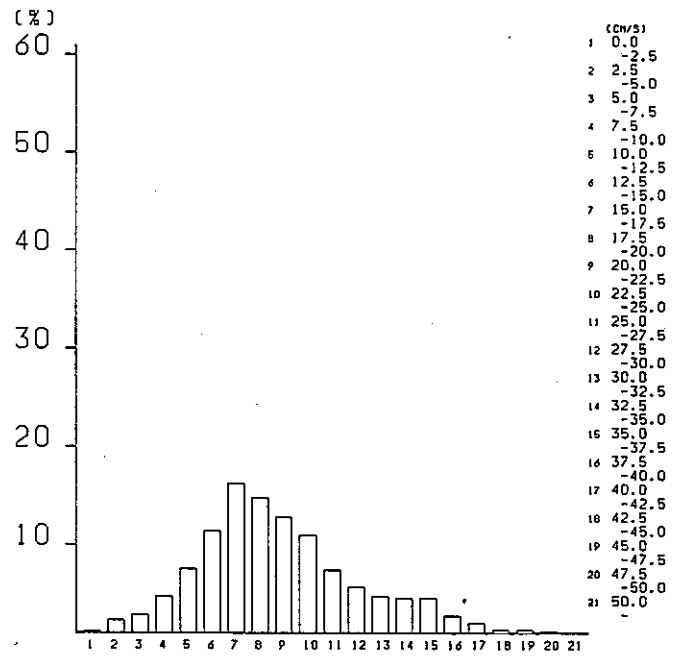
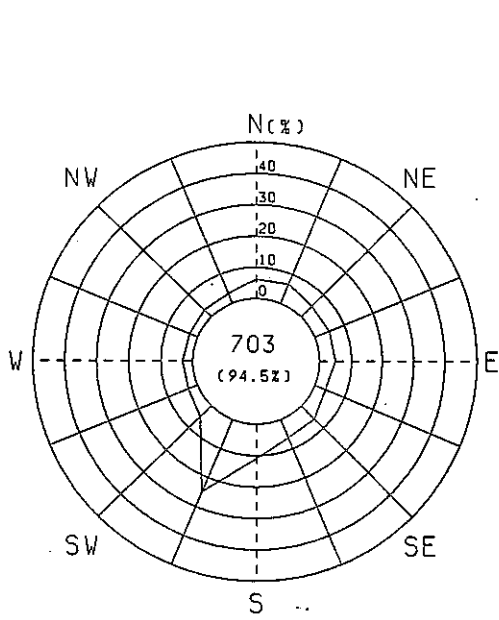

1982/7/1 0:00 - 1982/7/31 23:55

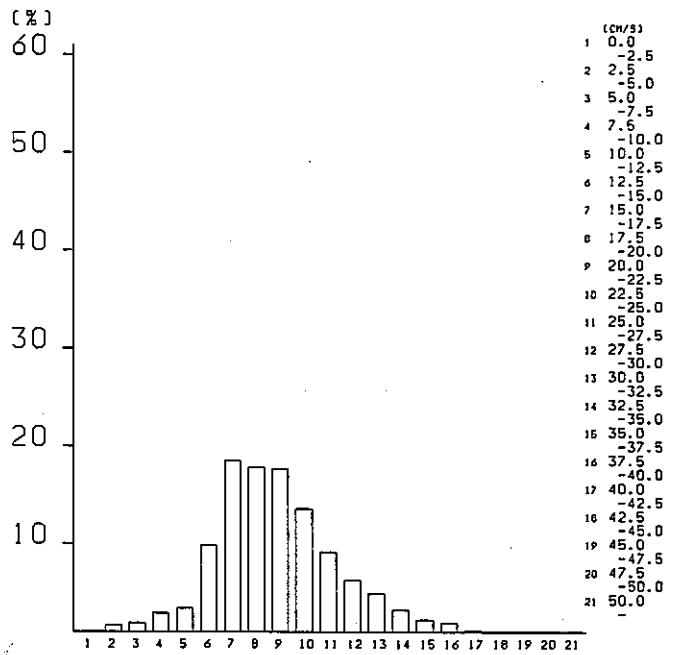
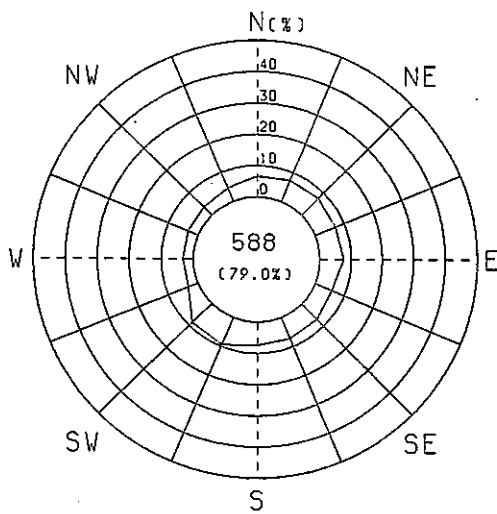

1982/8/1 0:00 - 1982/8/31 23:55

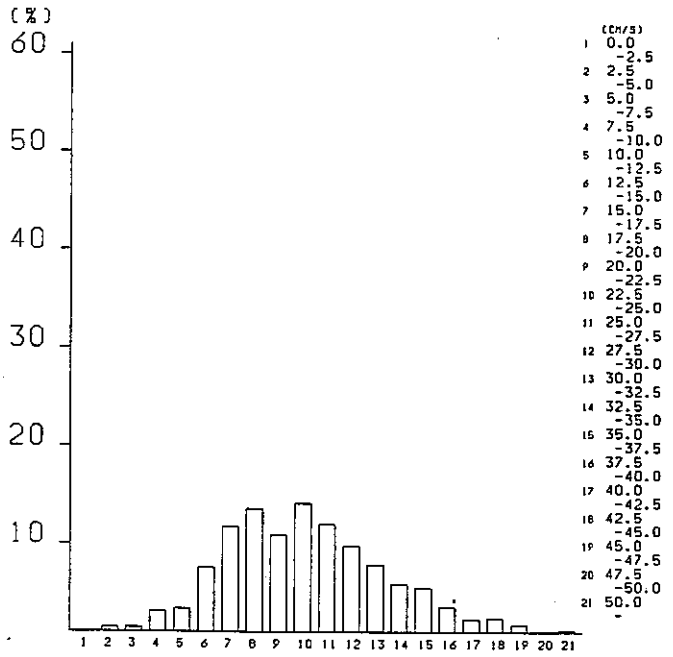
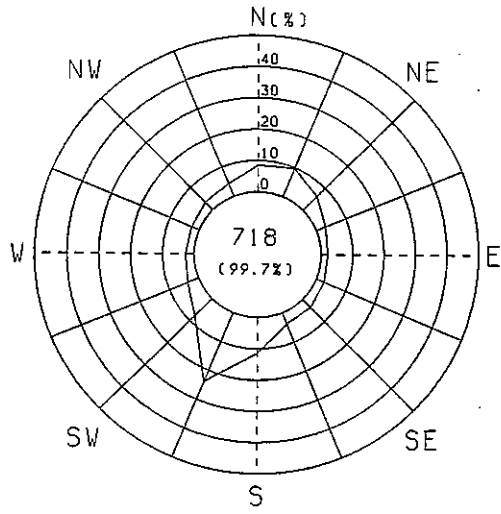

1982/9/1 0:00 - 1982/9/30 23:55

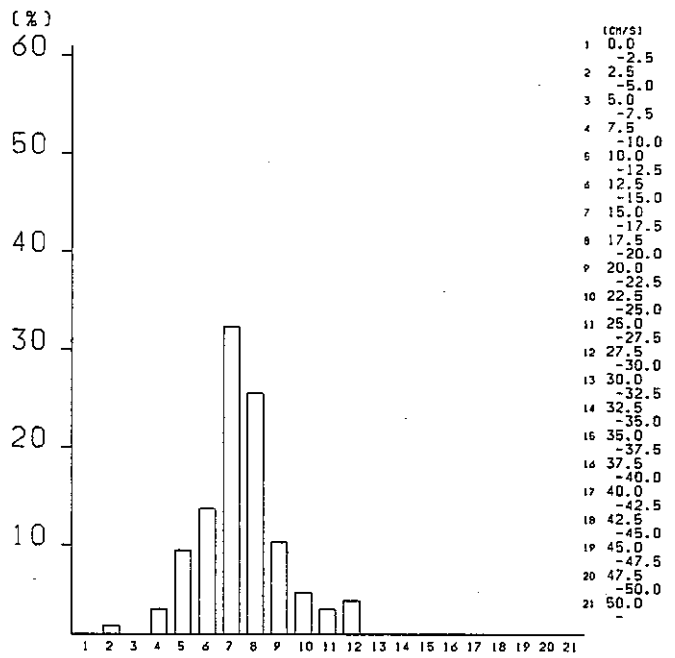
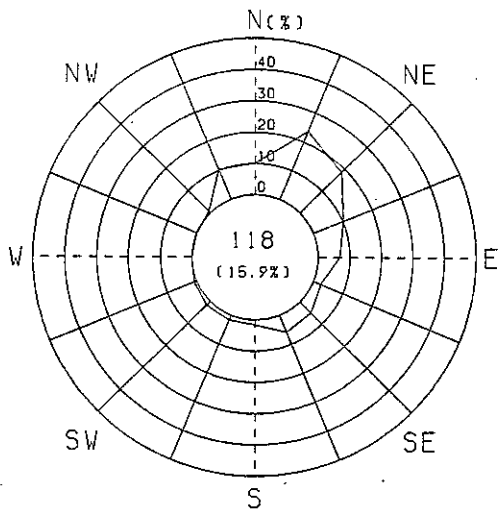

1982/10/1 0:00 - 1982/10/31 23:55

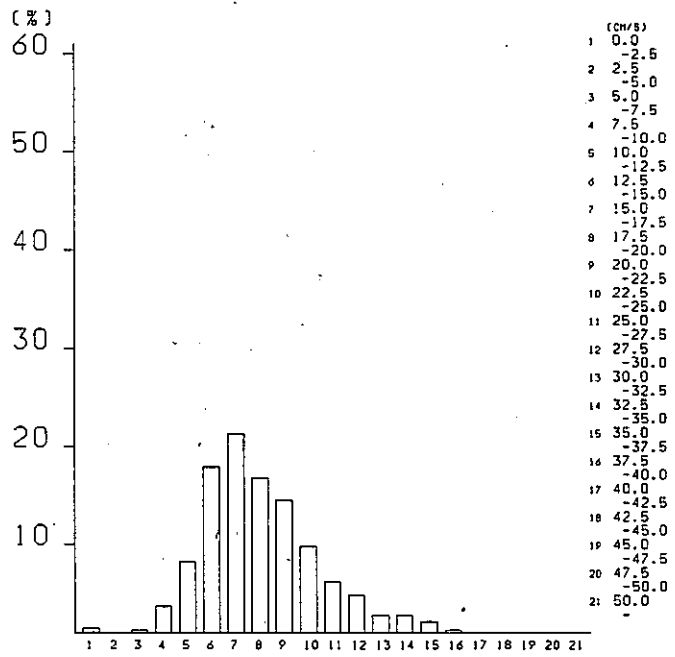
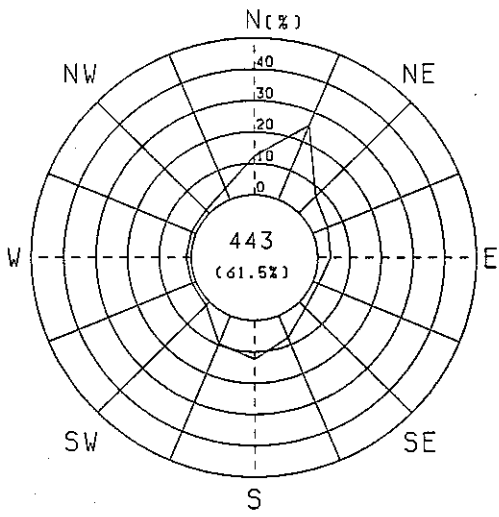

1982/11/1 0:00 - 1982/11/30 23:55

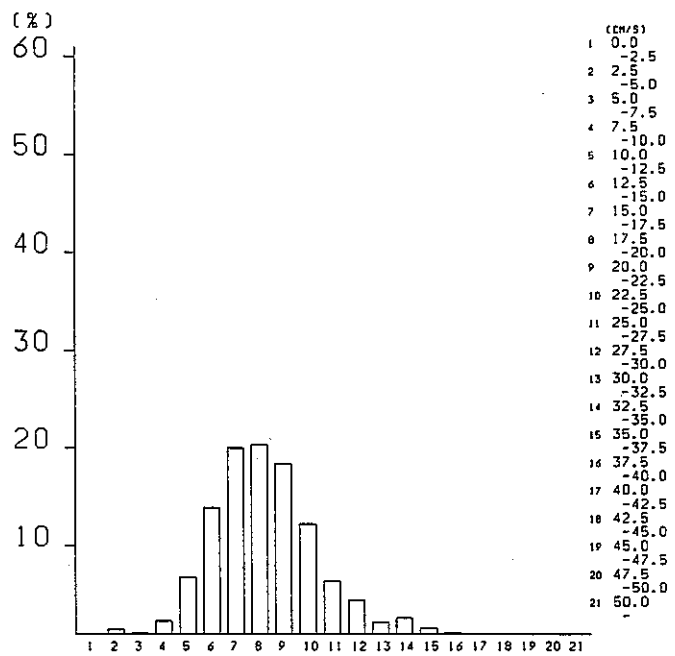
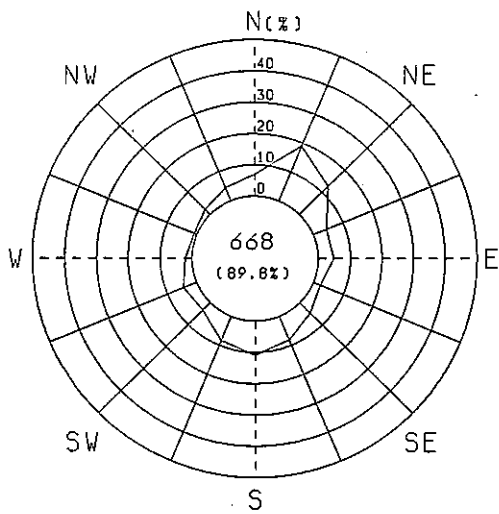

1982/12/1 0:00 - 1982/12/31 23:55

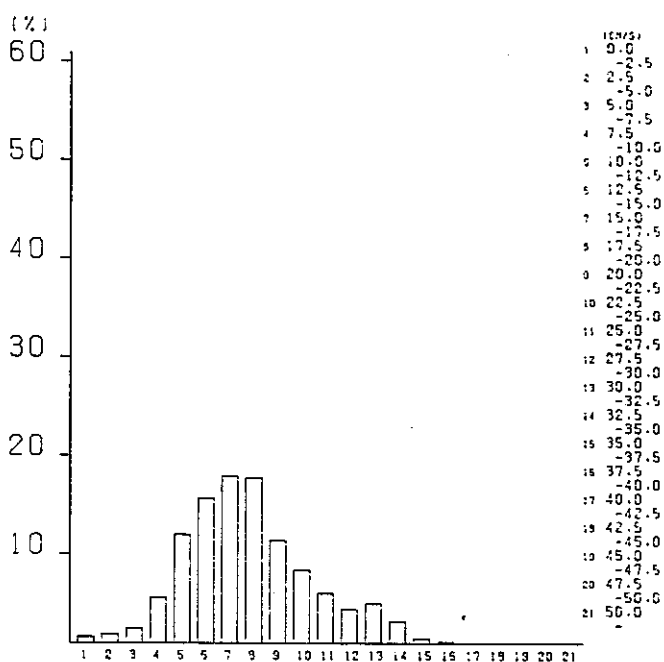
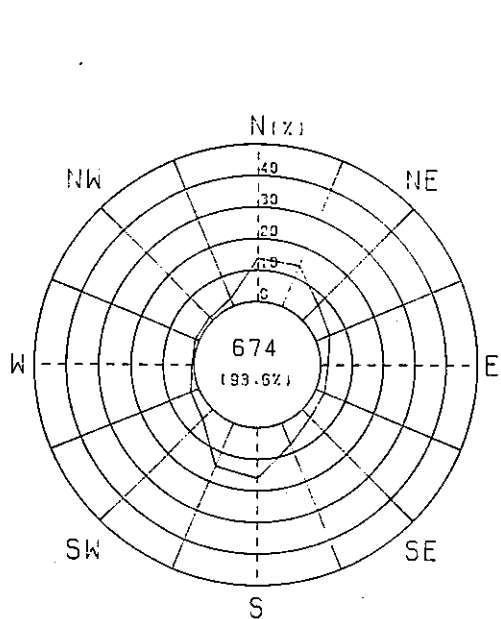

1983/1/2 0:00 - 1983/1/31 23:55

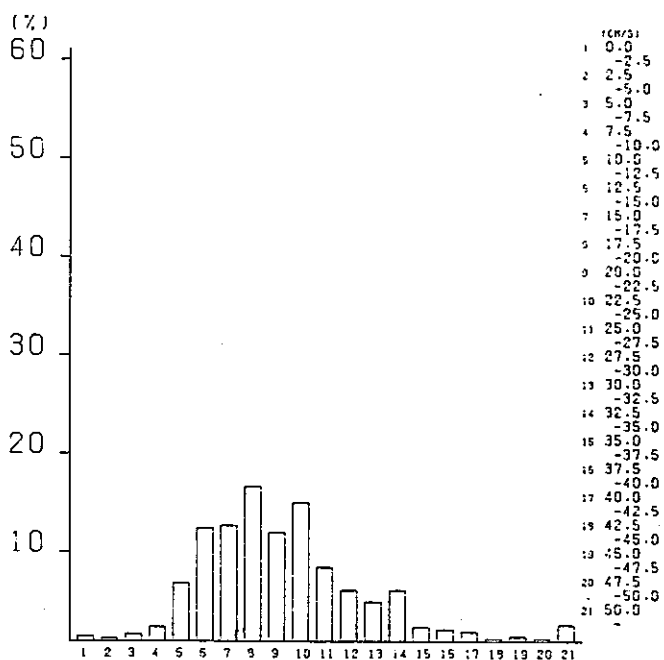
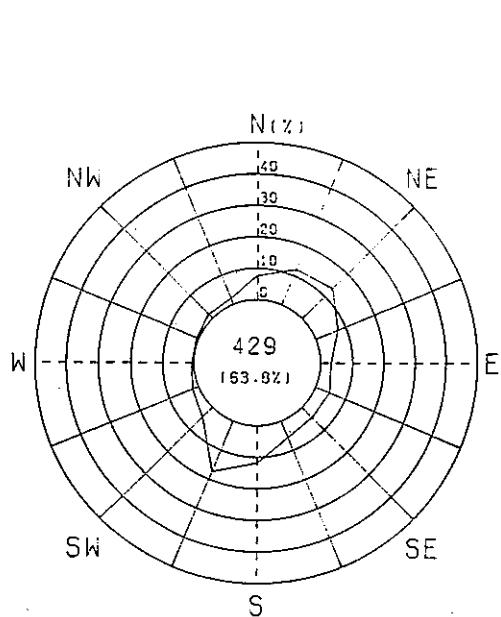

1983/2/1 0:00 - 1983/2/28 23:55

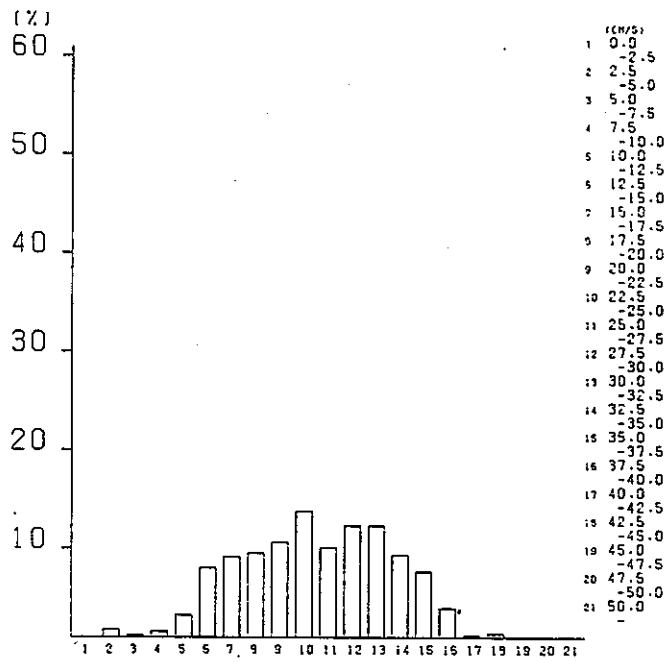
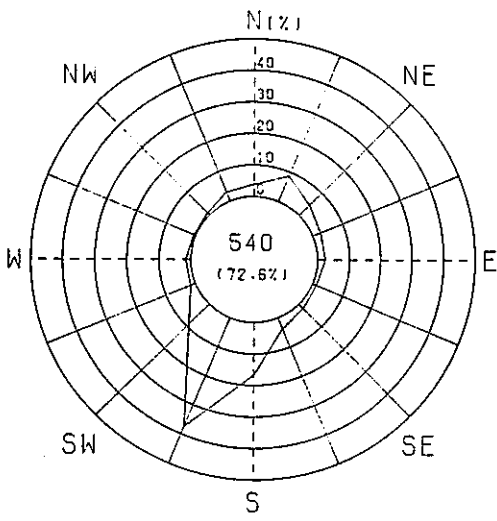

1983/3/1 0:00 - 1983/3/31 23:55

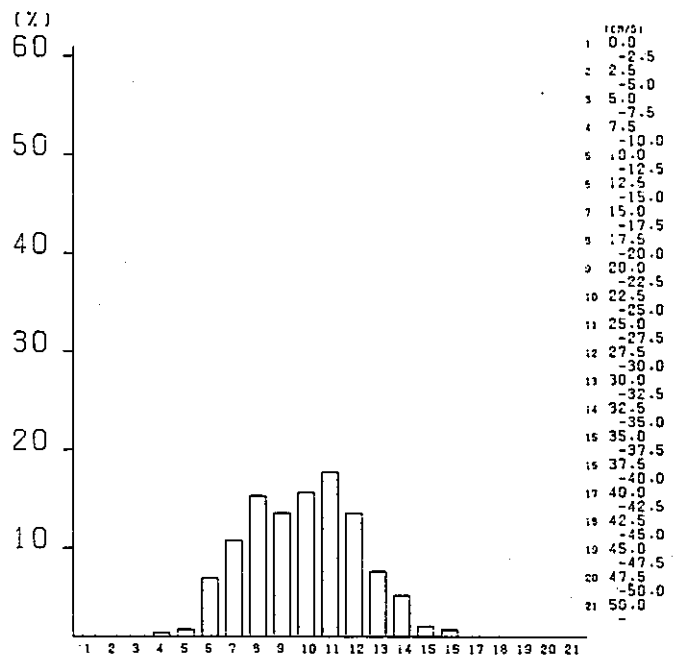
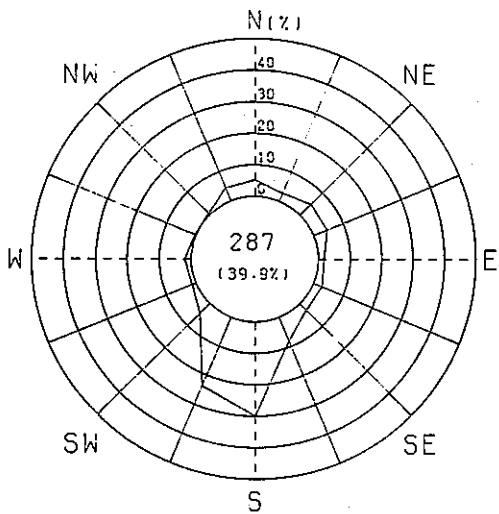

1983/4/1 0:00 - 1983/4/30 23:55

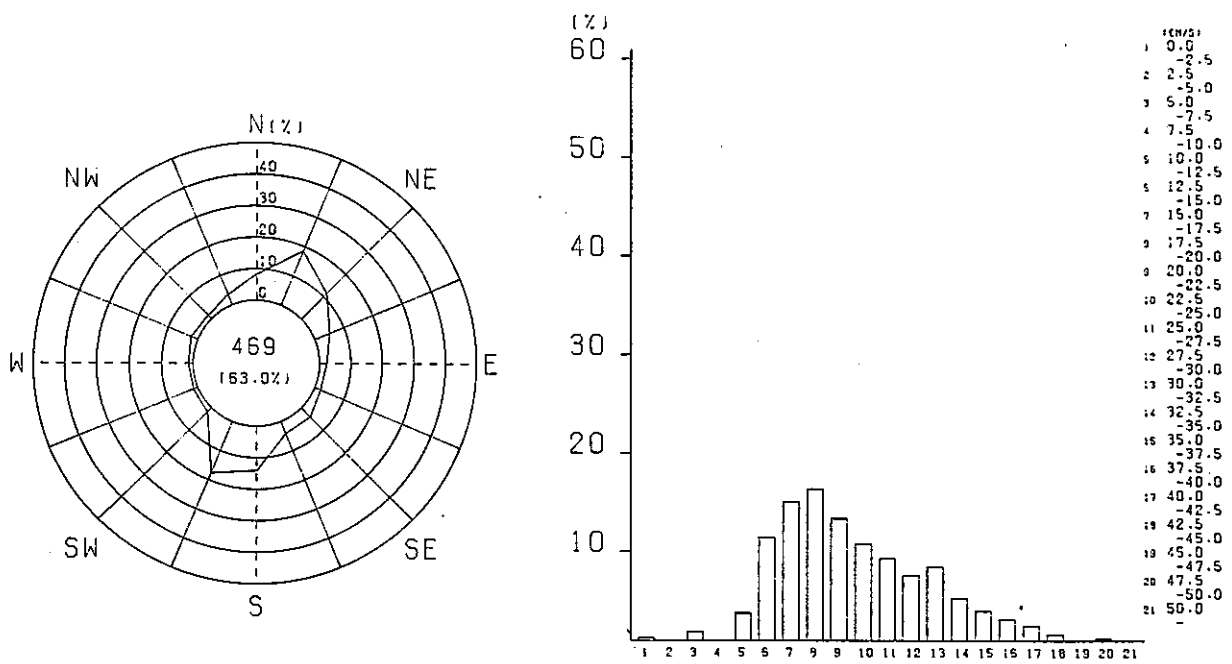

1983/5/1 0:00 - 1983/5/31 23:55

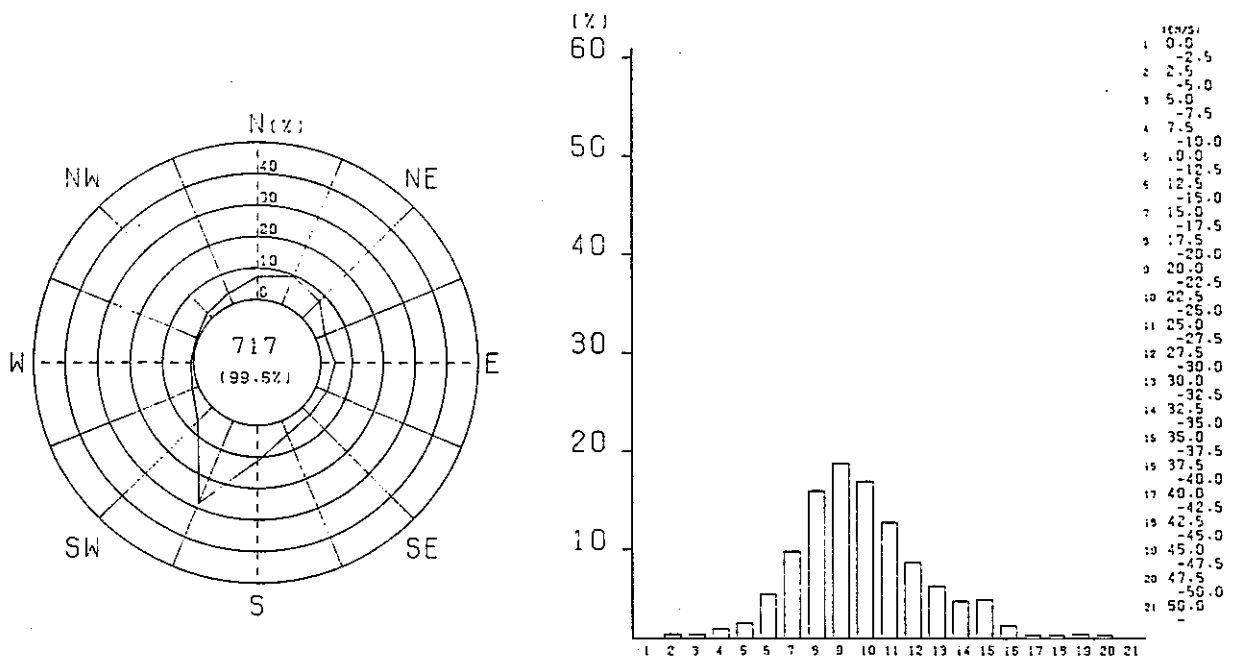

1983/6/1 0:00 - 1983/6/30 23:55

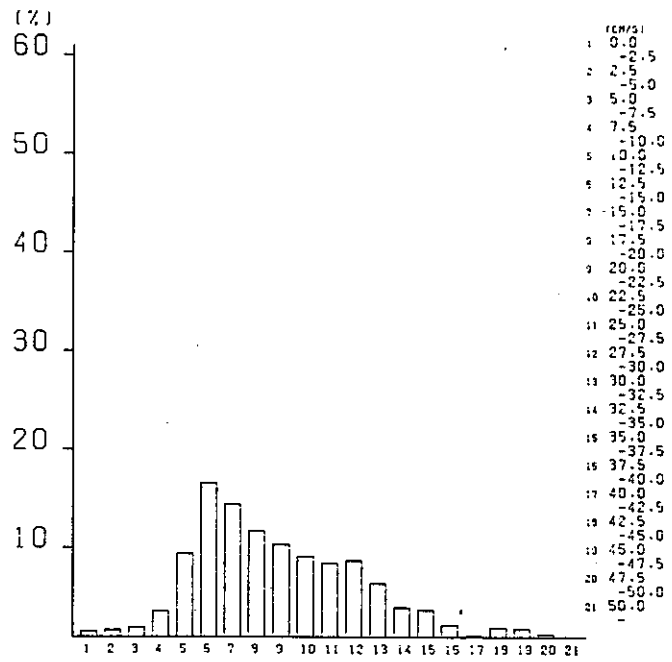
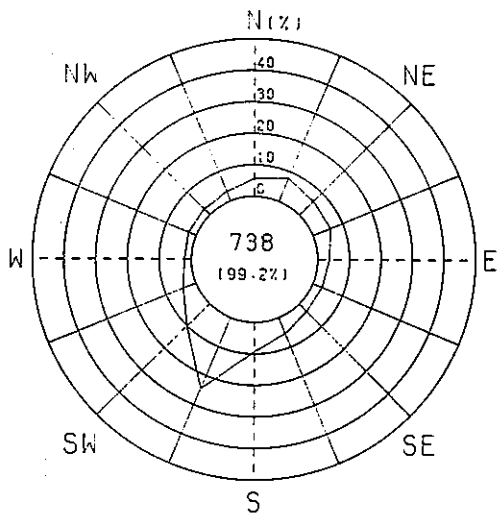

1983/7/1 0:00 - 1983/7/31 23:55

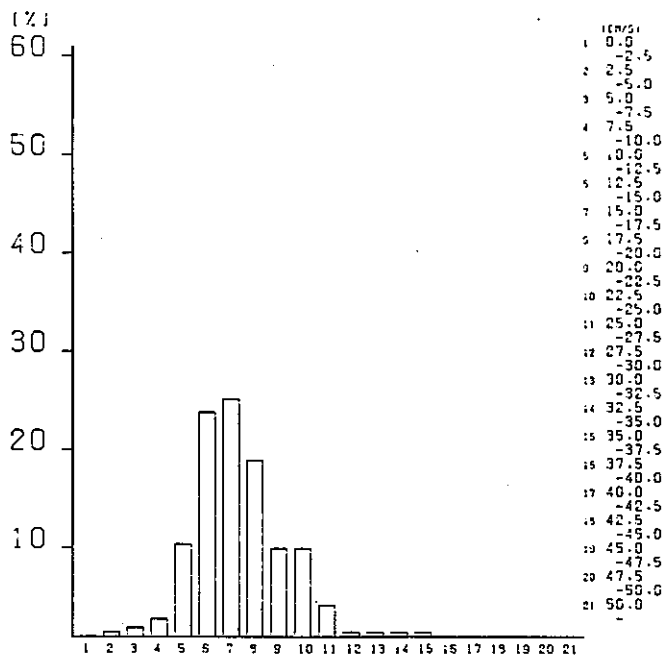
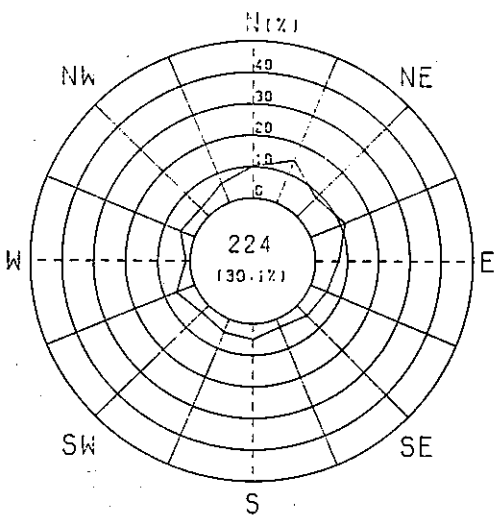

1983/8/1 0:00 - 1983/8/31 23:55

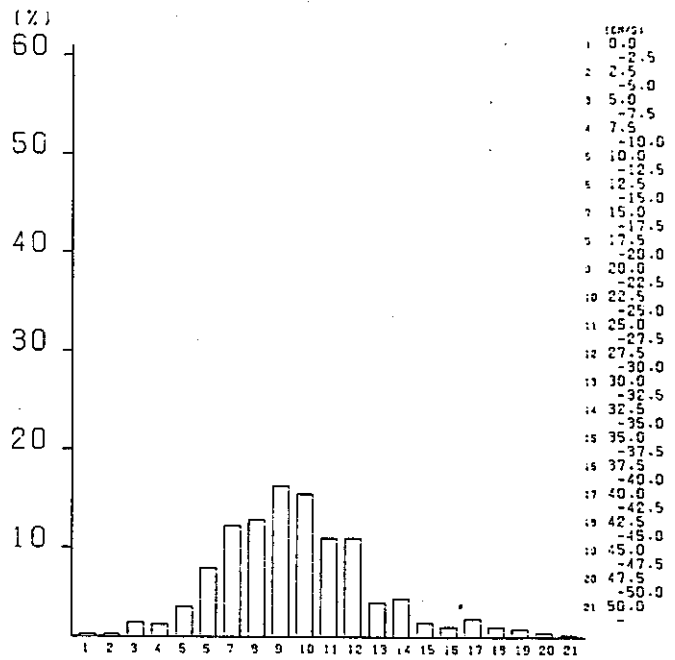
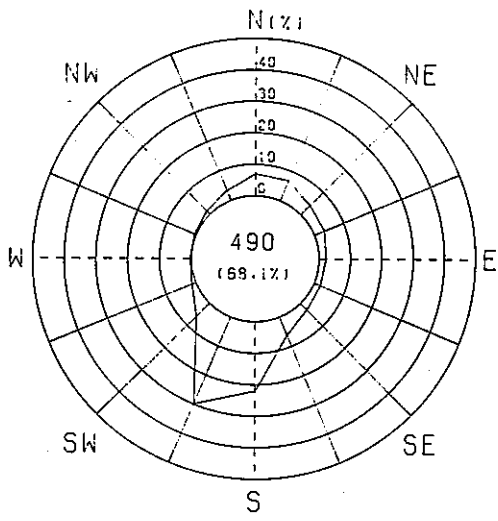

1983/9/1 0:00 - 1983/9/30 23:55

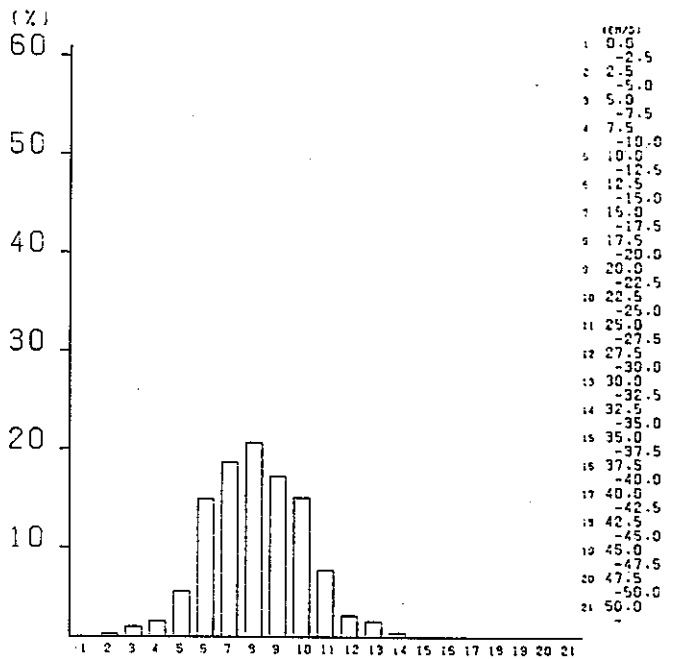
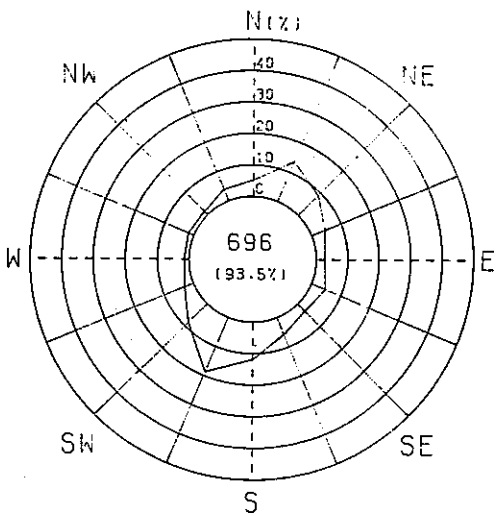

1983/10/1 0:00 - 1983/10/31 23:55

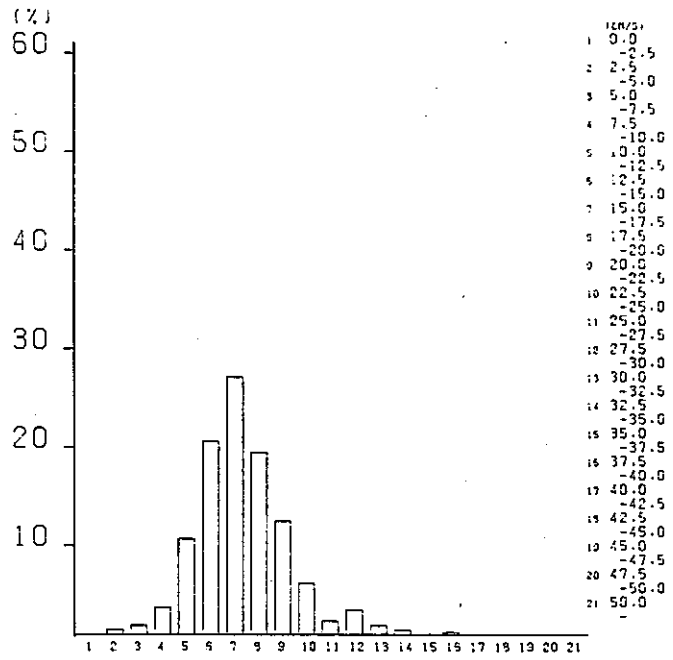
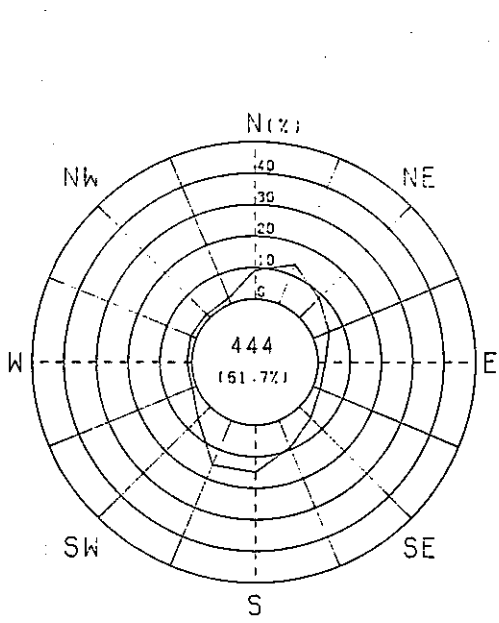

1983/11/1 0:00 - 1983/11/30 23:55

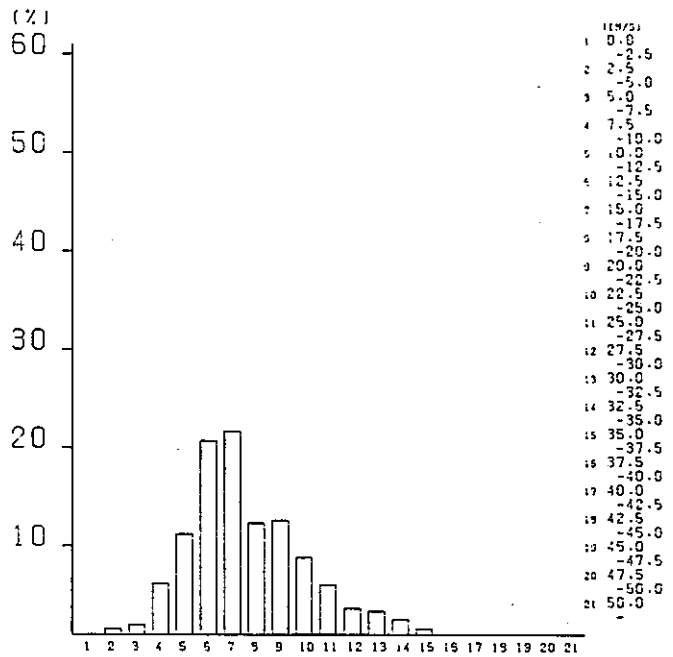
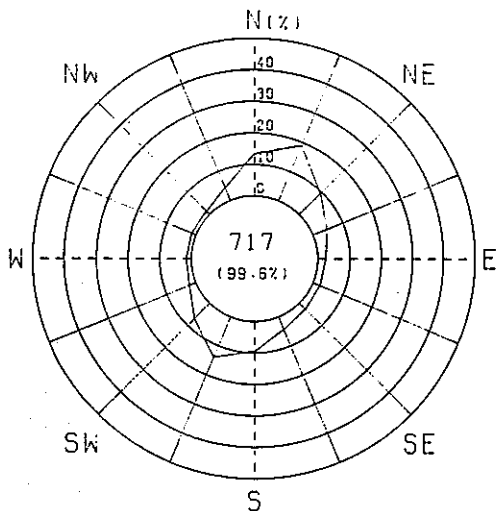

1983/12/1 0:00 - 1983/12/31 23:55

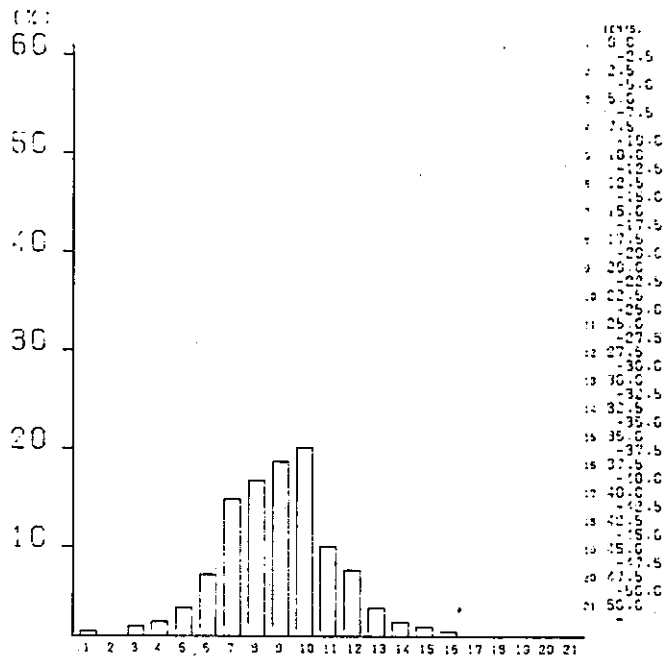
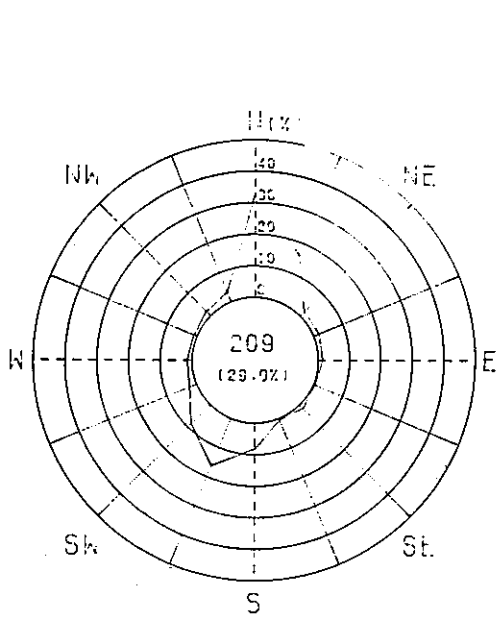

1984/1/2 0:00 - 1984/1/31 23:55

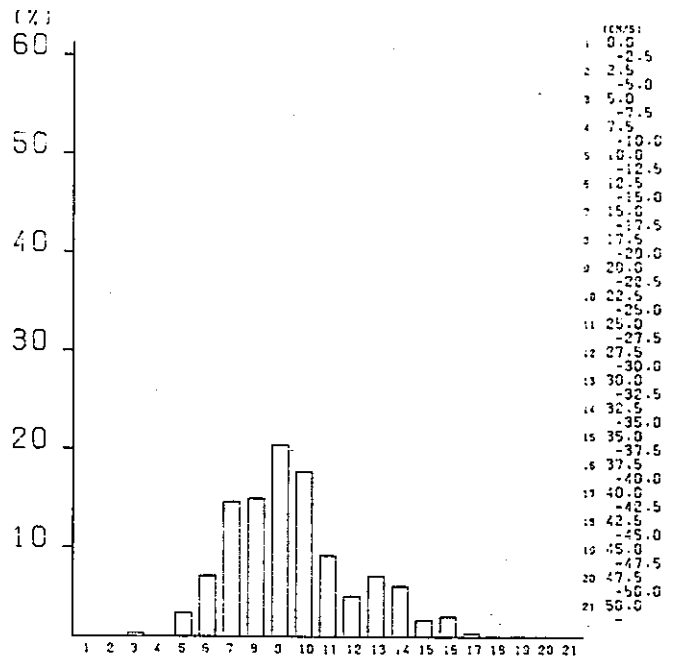
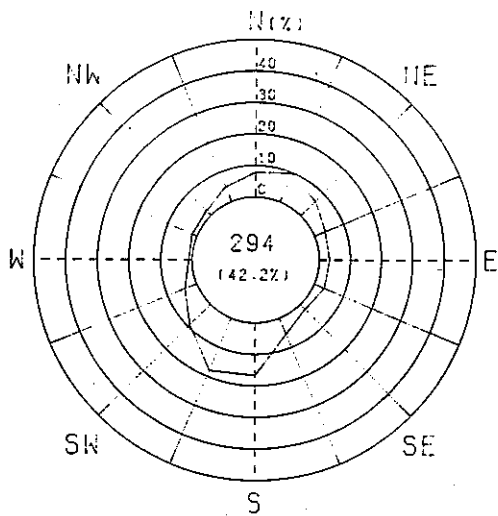

1984/2/1 0:00 - 1984/2/28 23:55

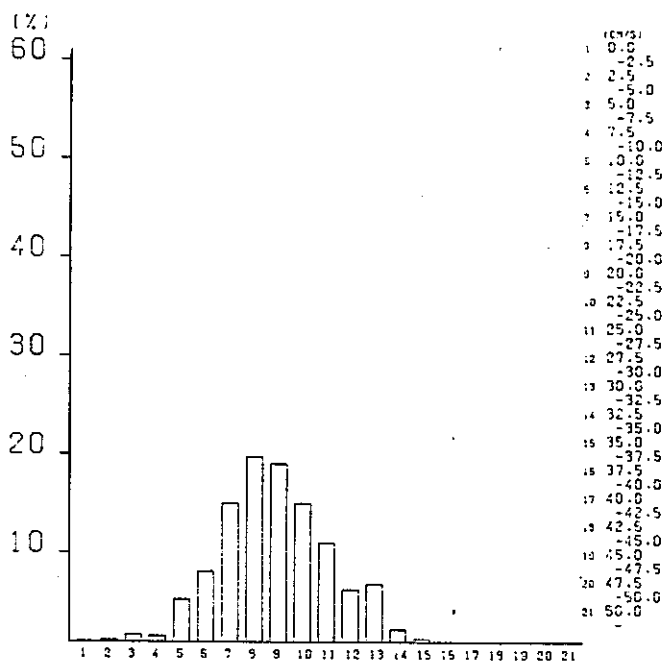
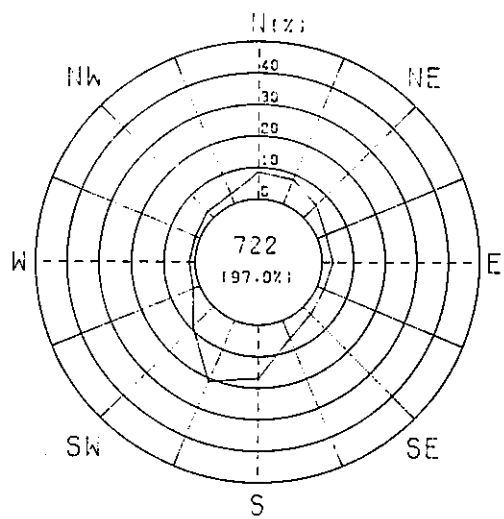

1984/3/1 0:00 - 1984/3/31 23:55

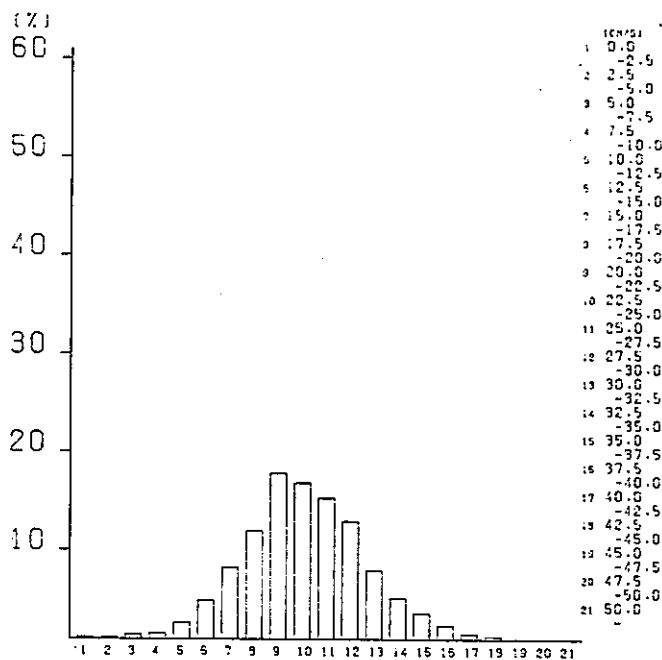
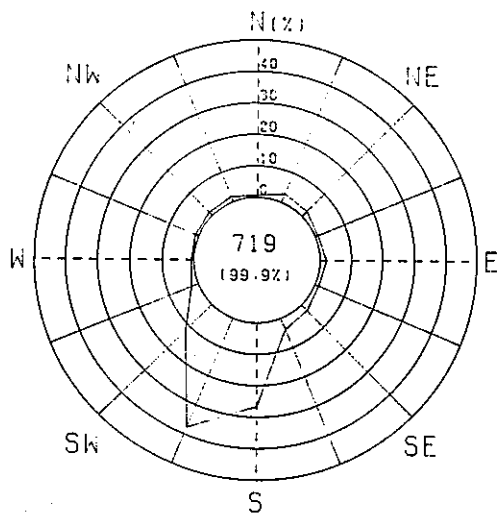

1984/4/1 0:00 - 1984/4/30 23:55

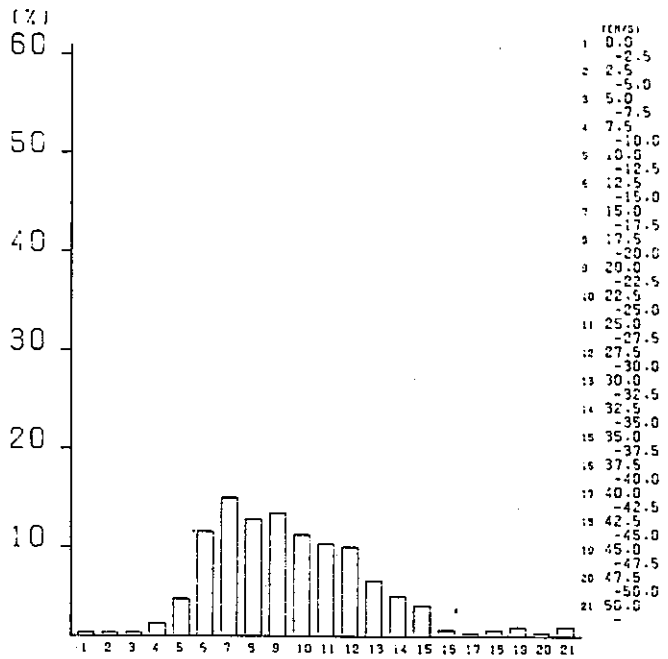
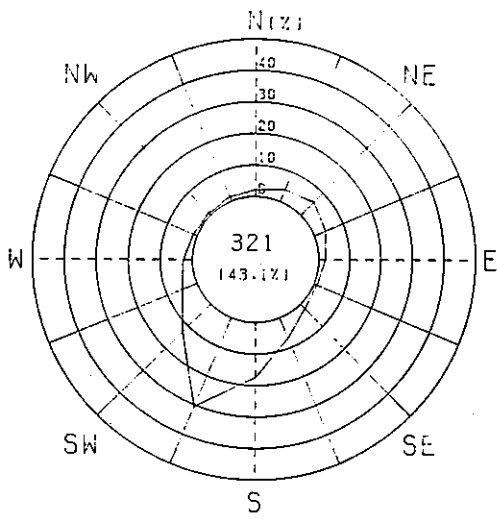

1984/5/1 0:00 - 1984/5/31 23:55

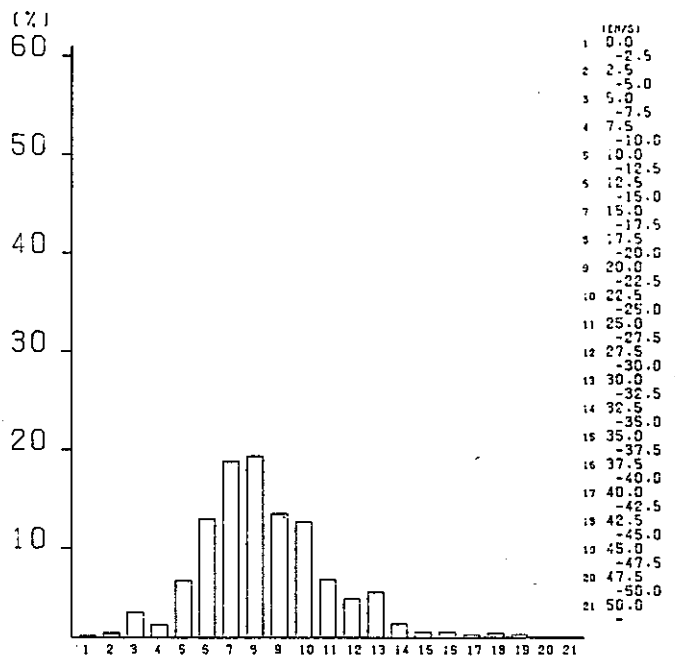
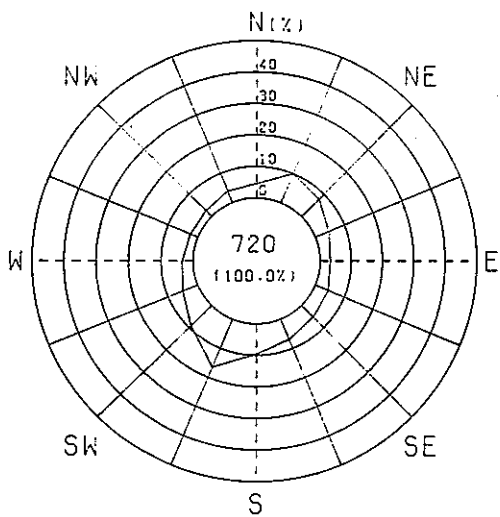

1984/6/1 0:00 - 1984/6/30 23:55

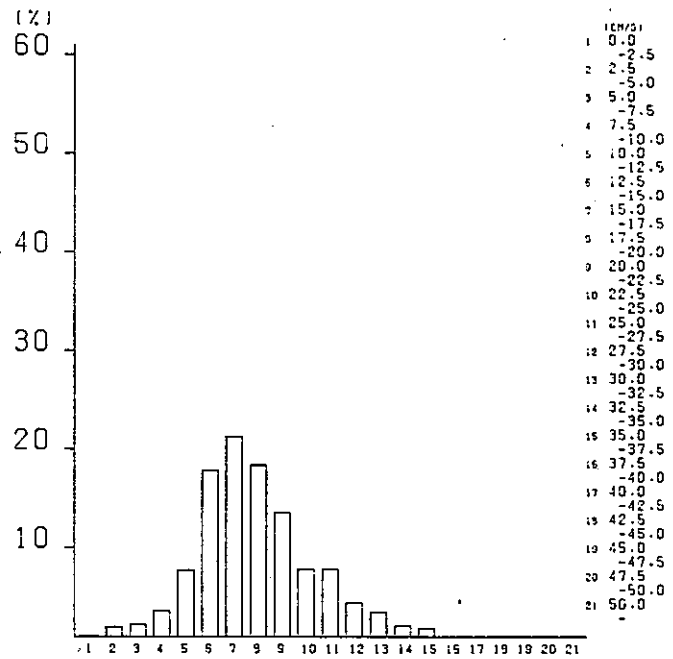
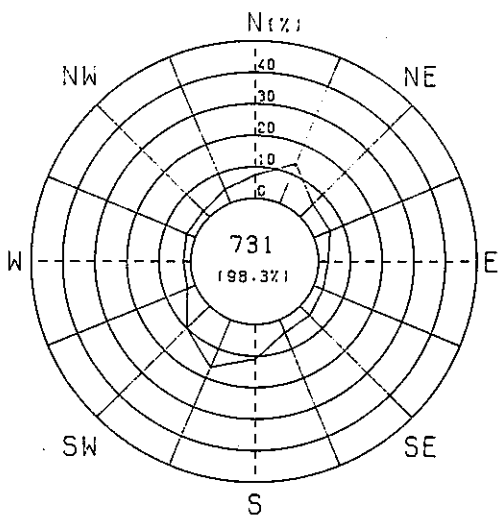

1984/7/1 0:00 - 1984/7/31 23:55

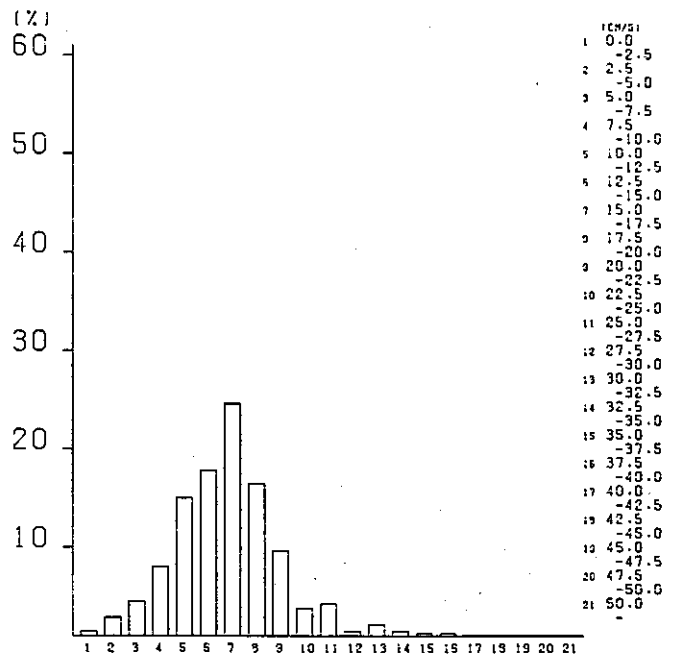
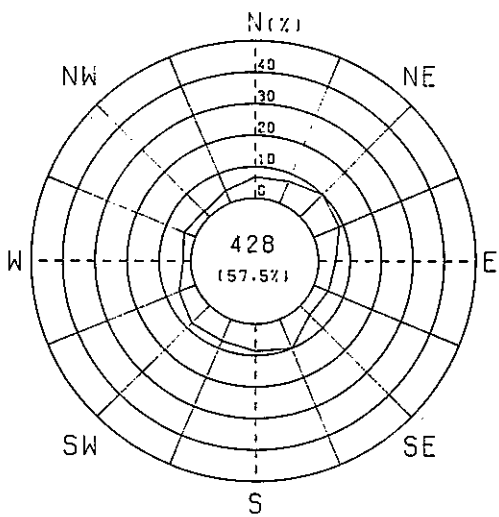

1984/8/1 0:00 - 1984/8/31 23:55

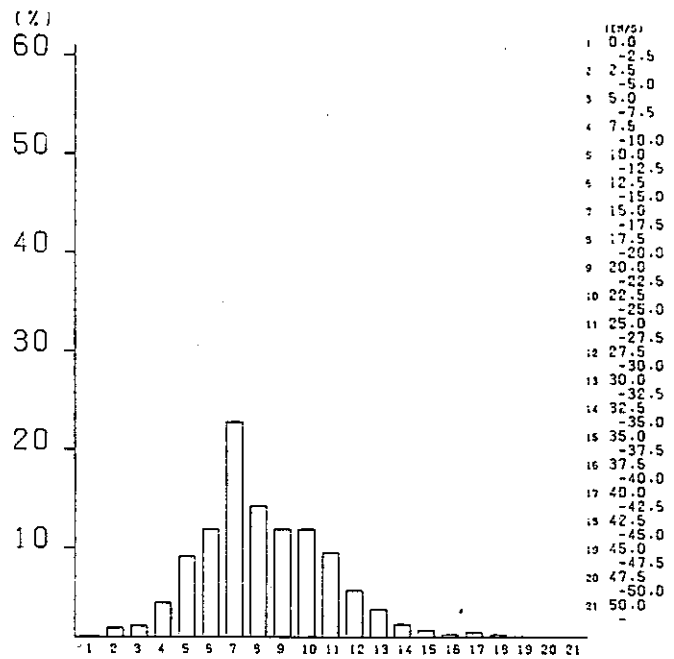
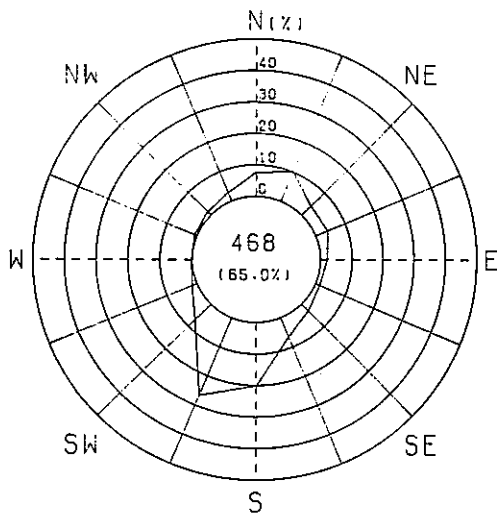

1984/9/1 0:00 - 1984/9/30 23:55

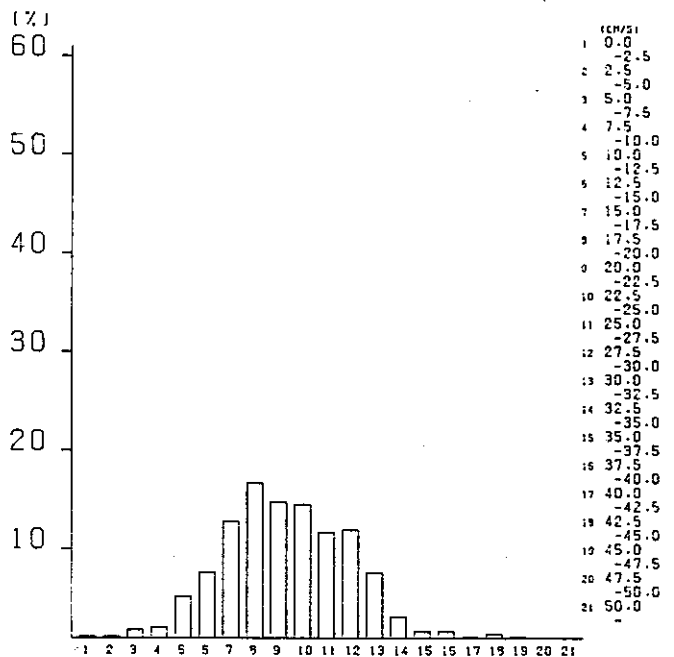
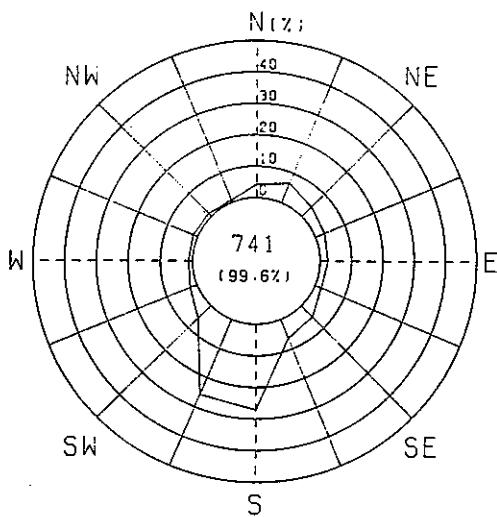

1984/10/1 0:00 - 1984/10/31 23:55

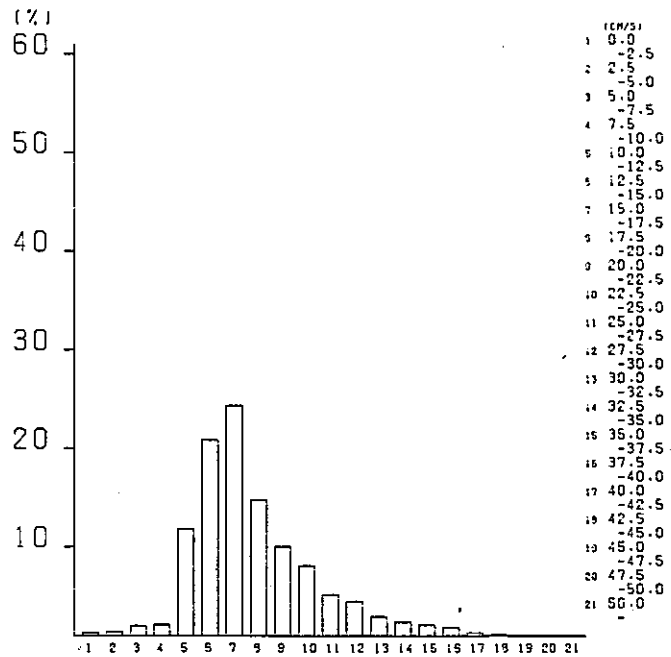
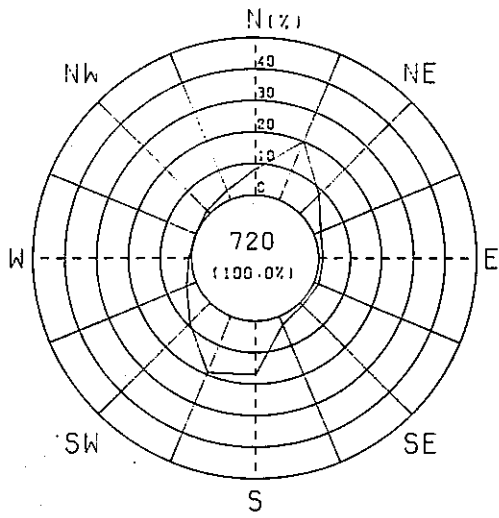

1984/11/1 0:00 - 1984/11/30 23:55

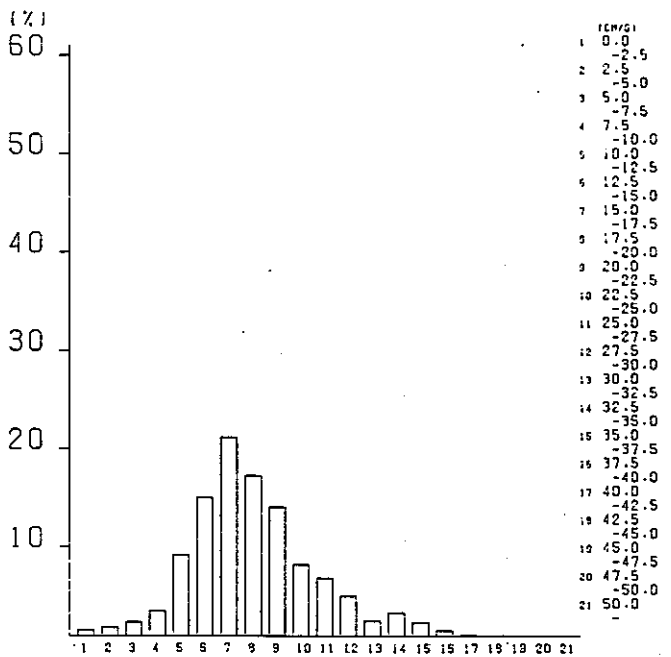
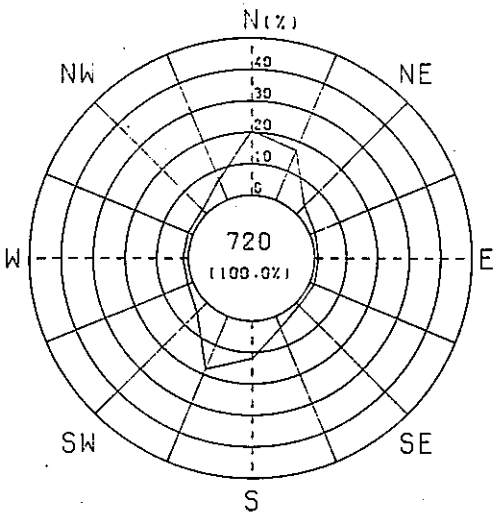

1984/12/1 0:00 - 1984/12/31 23:55

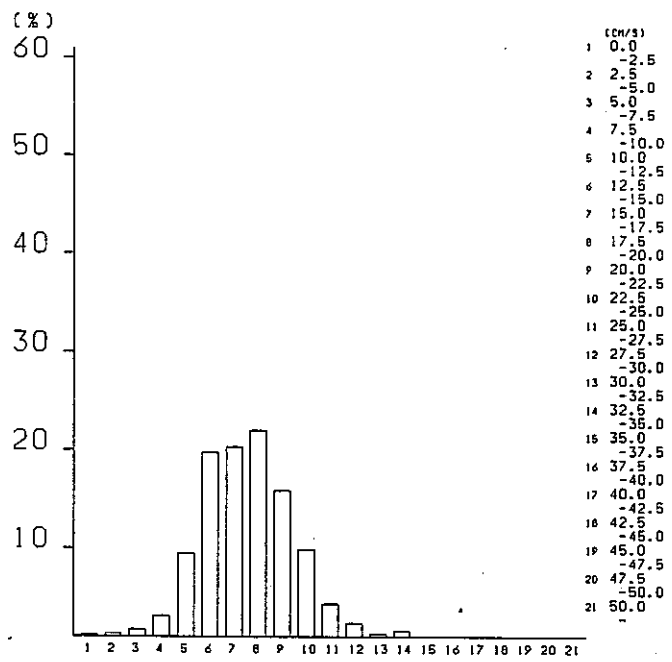
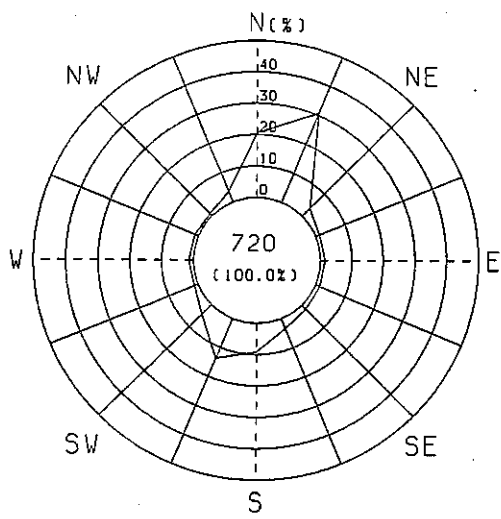

1985/1/2 0:00 - 1985/1/31 23:55

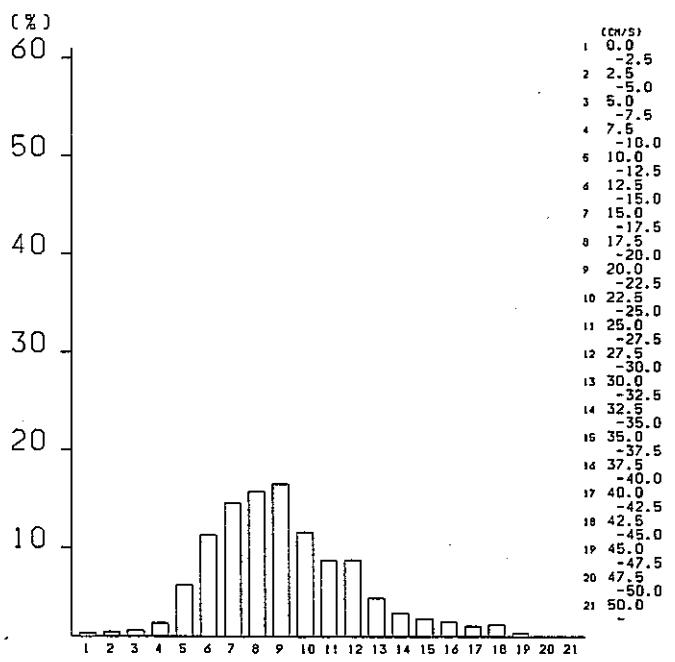
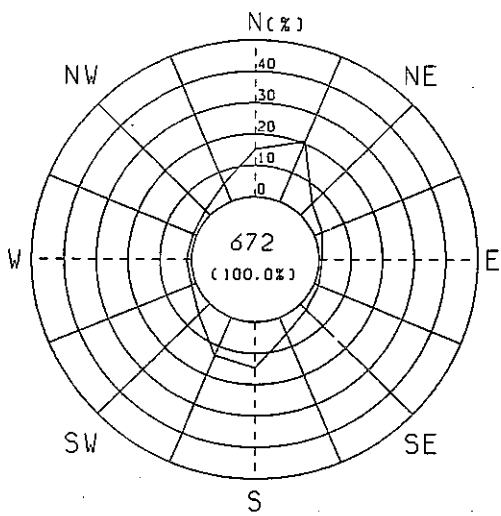

1985/2/1 0:00 - 1985/2/28 23:55

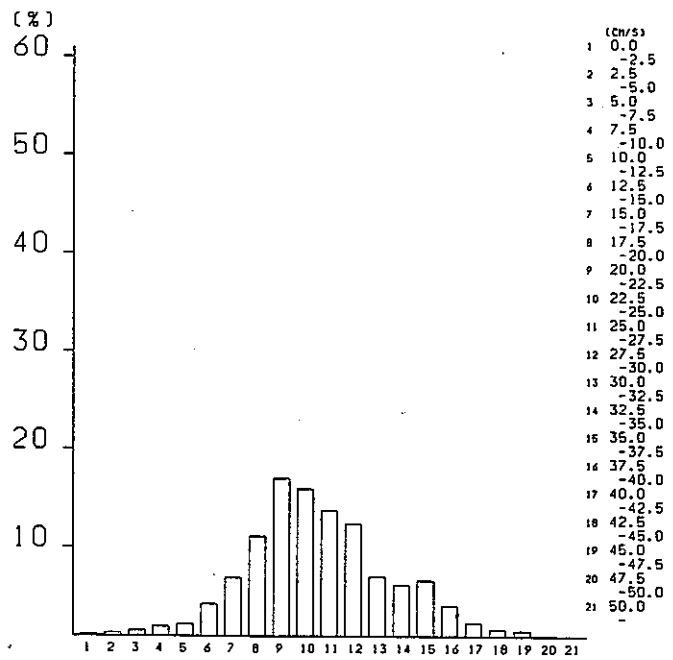
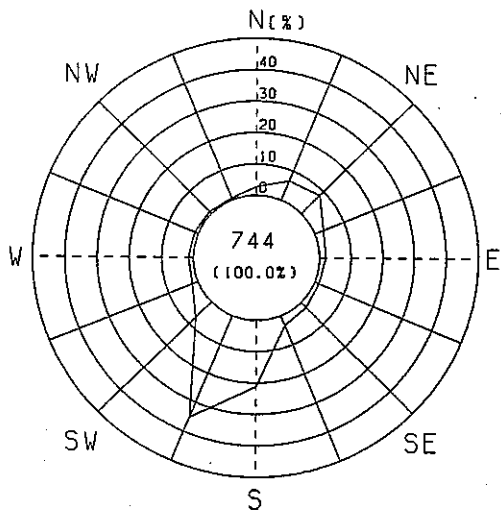

1985/3/1 0:00 - 1985/3/31 23:55

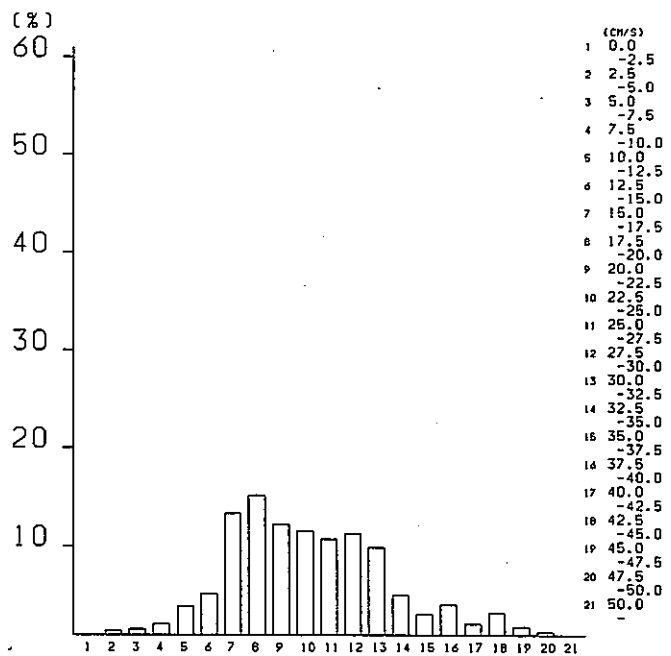
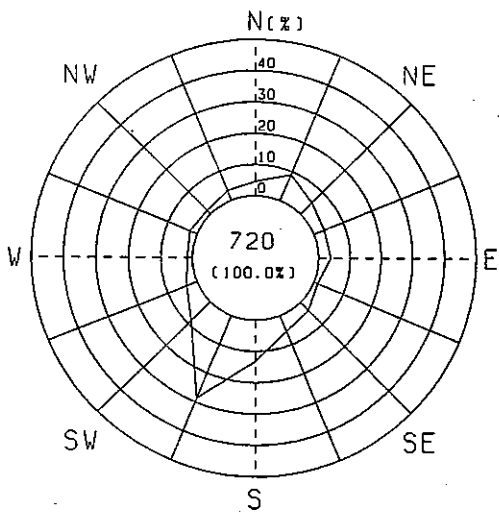

1985/4/1 0:00 - 1985/4/30 23:55

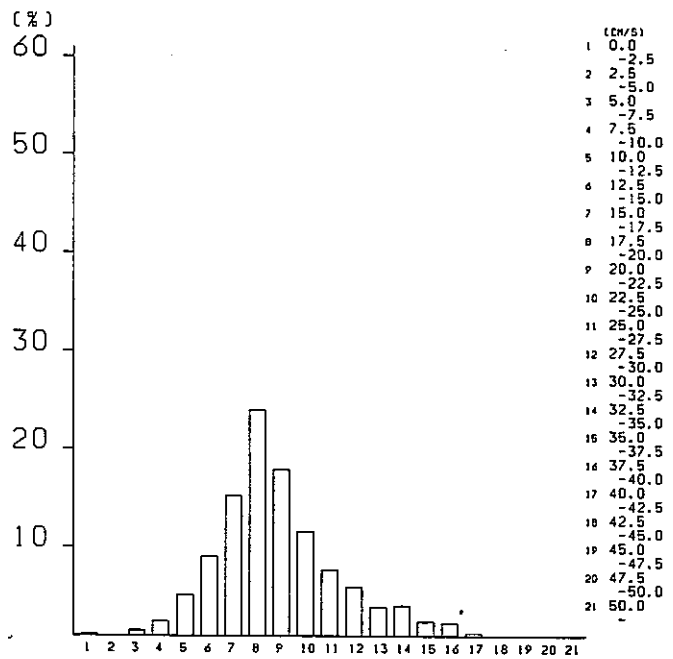
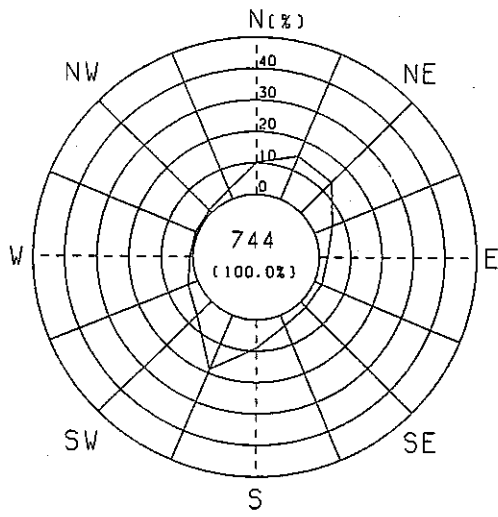

1985/5/1 0:00 - 1985/5/31 23:55

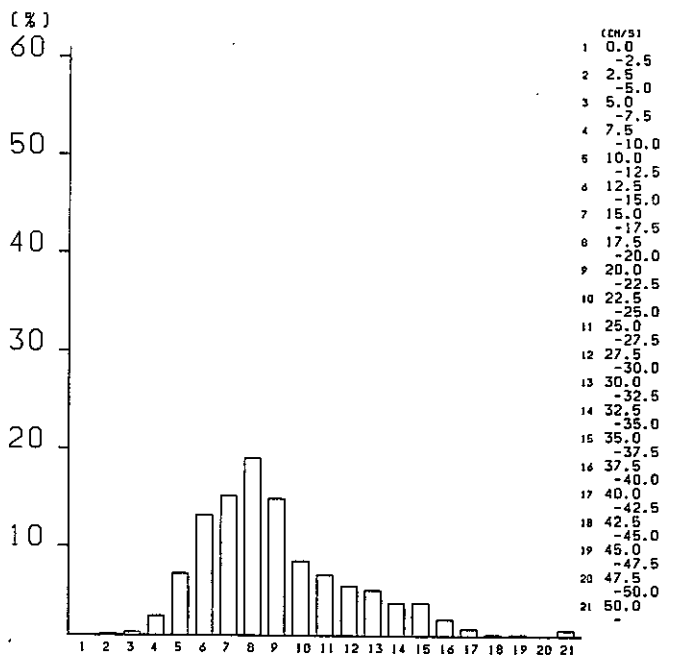
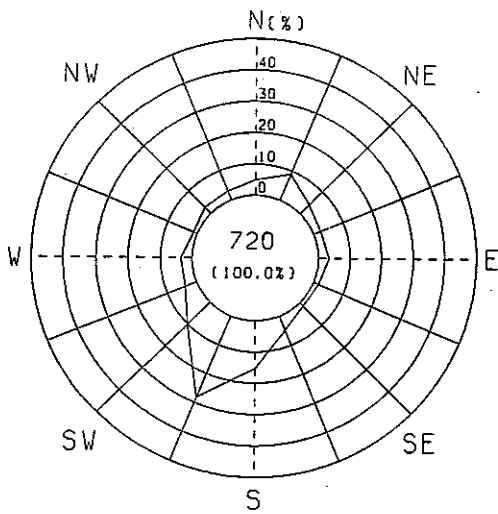

1985/6/1 0:00 - 1985/6/30 23:55

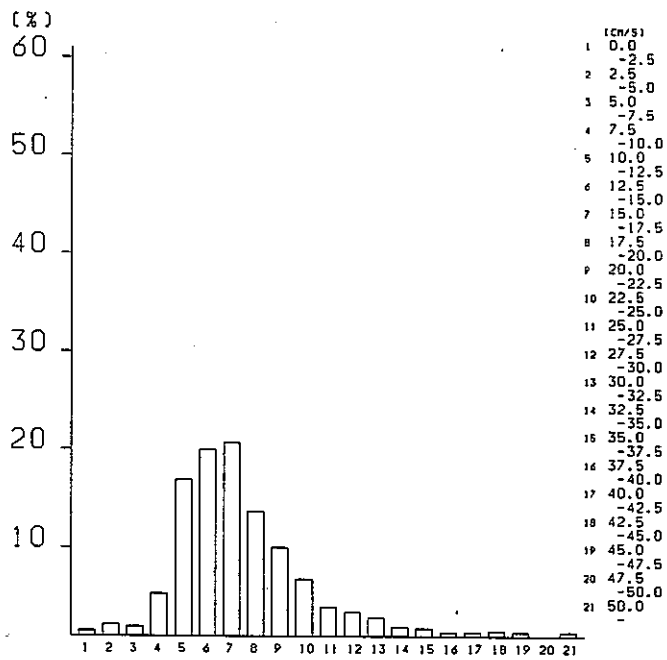
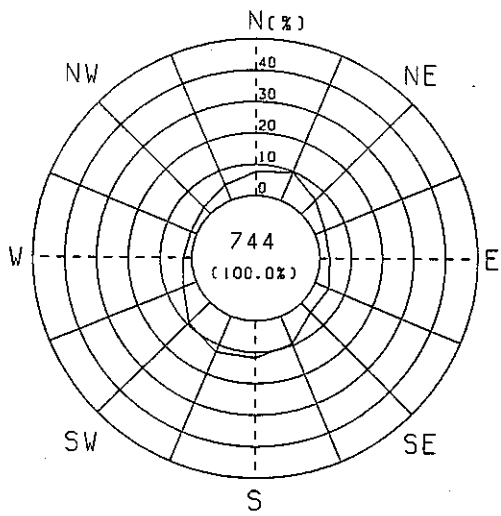

1985/7/1 0:00 - 1985/7/31 23:55

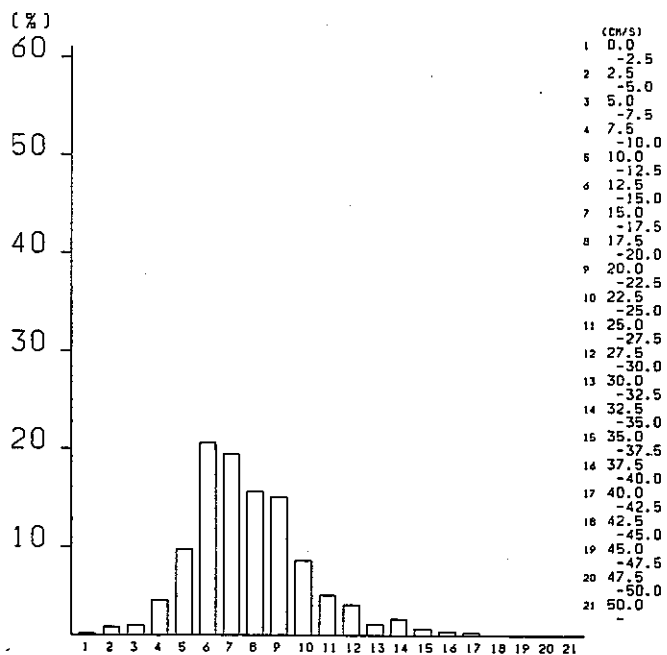
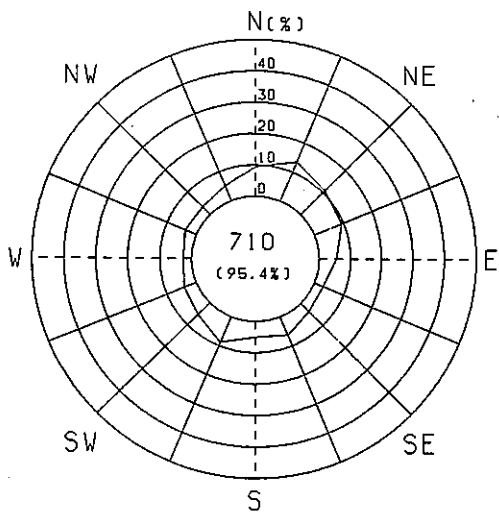

1985/8/1 0:00 - 1985/8/31 23:55

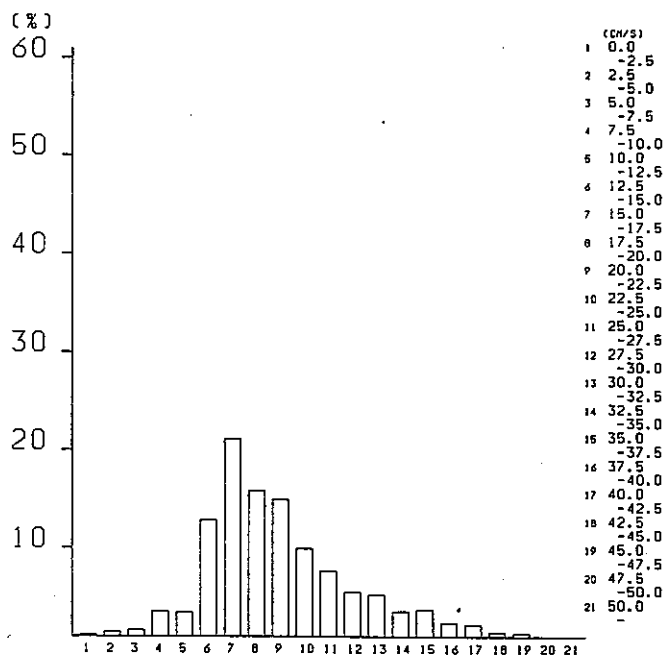
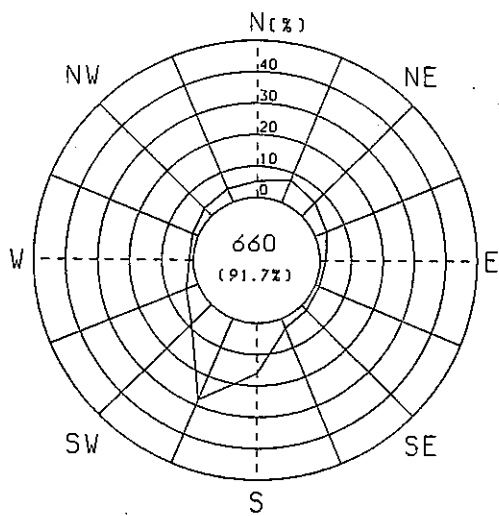

1985/9/1 0:00 - 1985/9/30 23:55

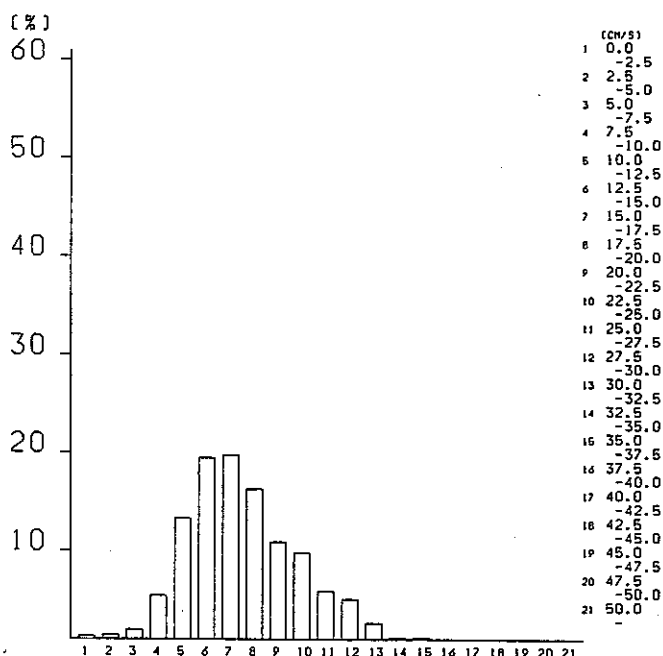
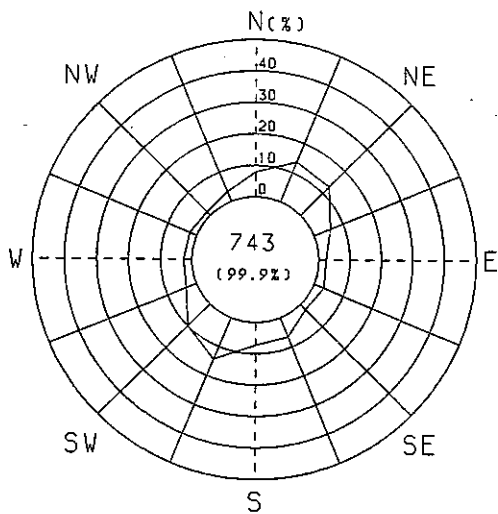

1985/10/1 0:00 - 1985/10/31 23:55

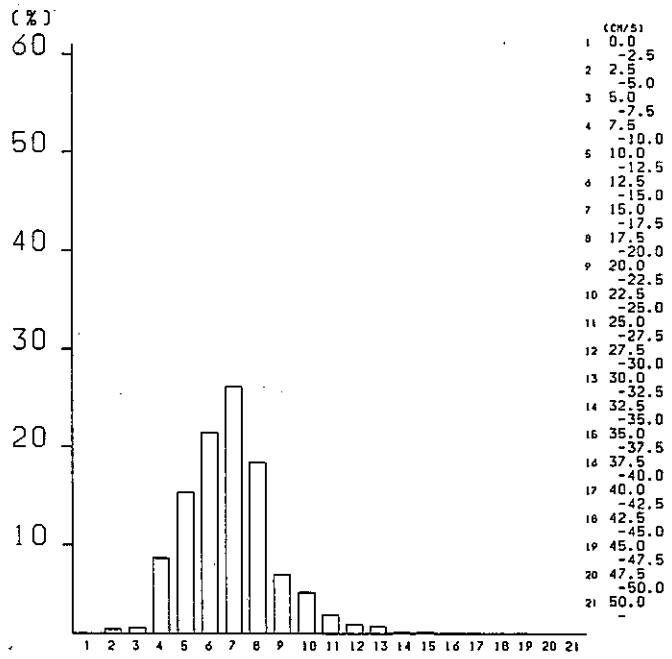
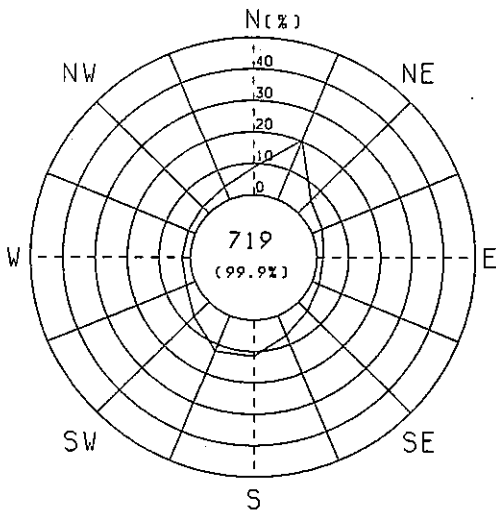

1985/11/1 0:00 - 1985/11/30 23:55

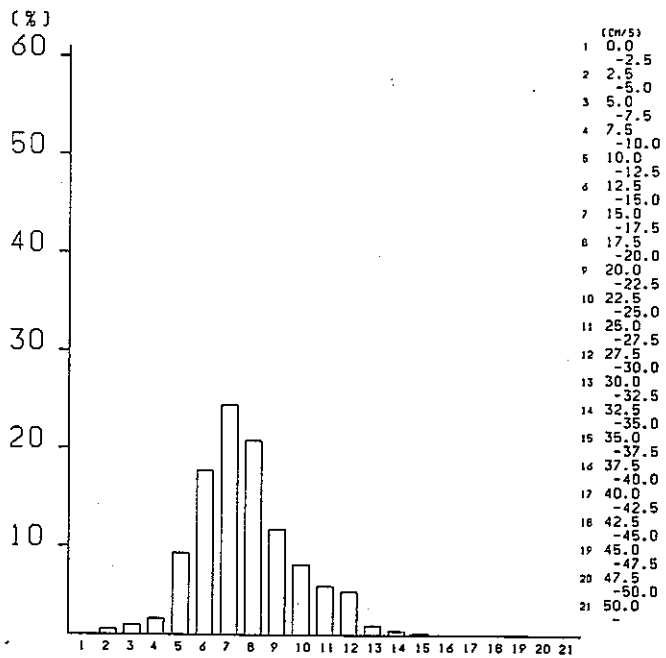
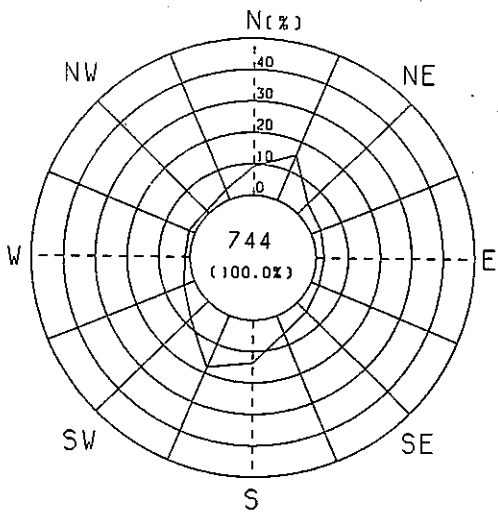

1985/12/1 0:00 - 1985/12/31 23:55

2、海面下10m層における流向頻度及び流速階級頻度の解析結果

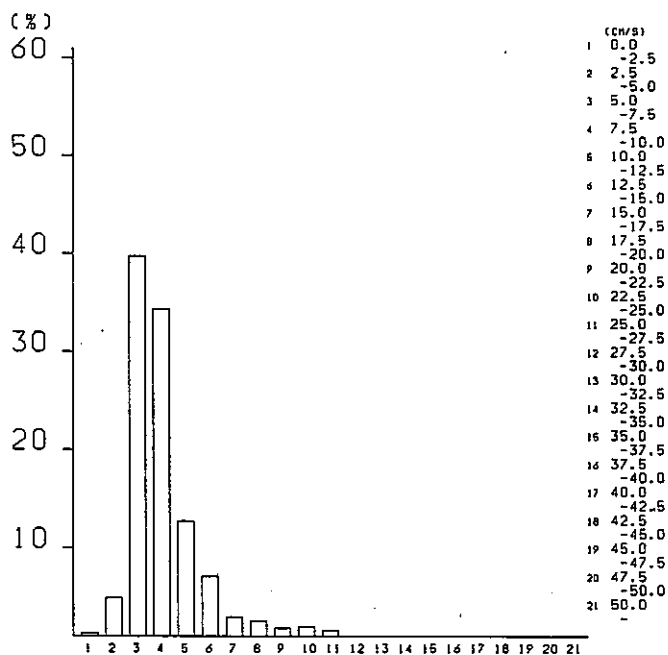
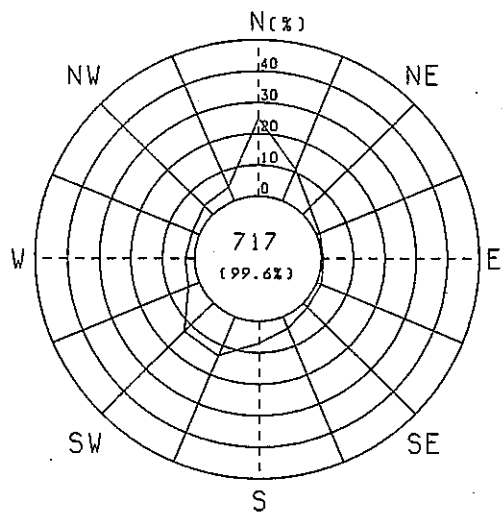

1981/1/2 0:00 - 1981/1/31 23:55

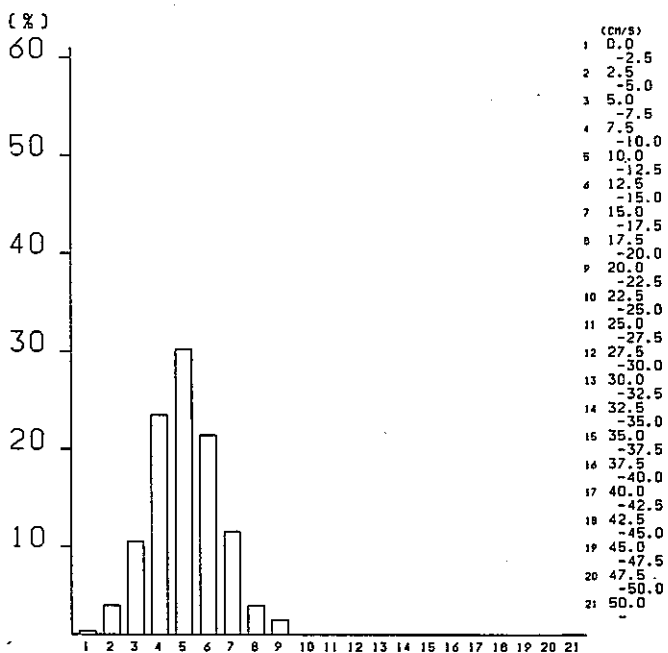
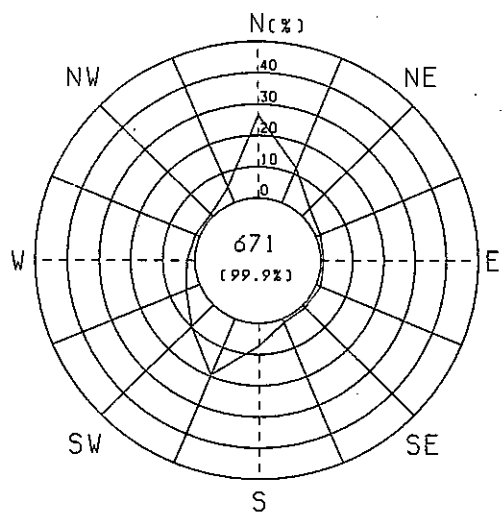

1981/2/1 0:00 - 1981/2/28 23:55

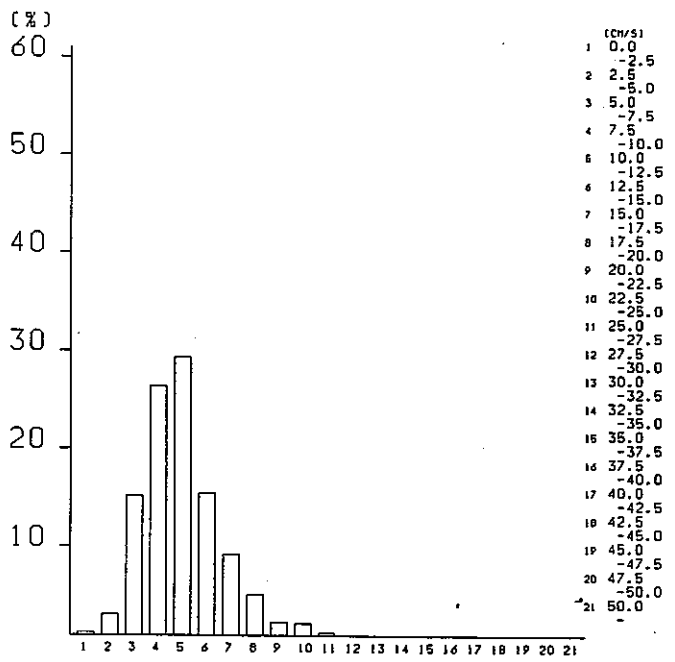
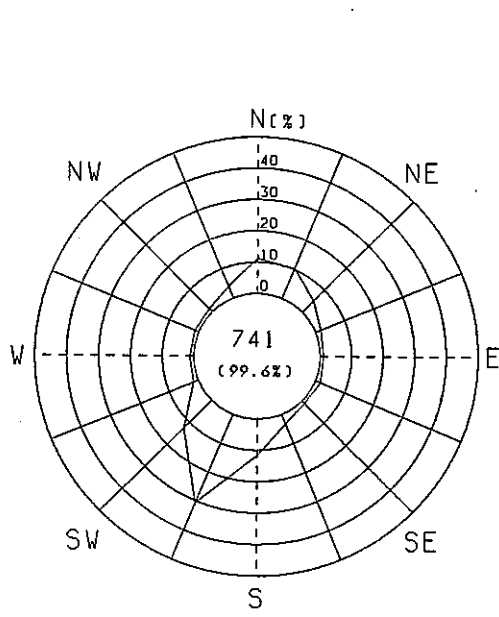

1981/3/1 0:00 - 1981/3/31 23:55

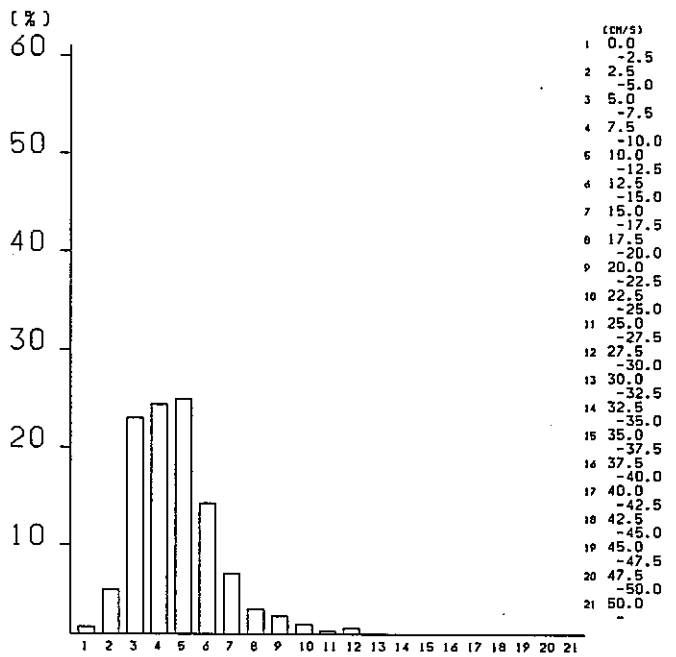
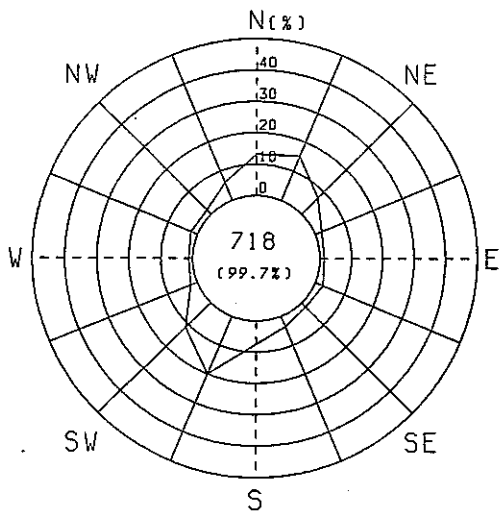

1981/4/1 0:00 - 1981/4/30 23:55

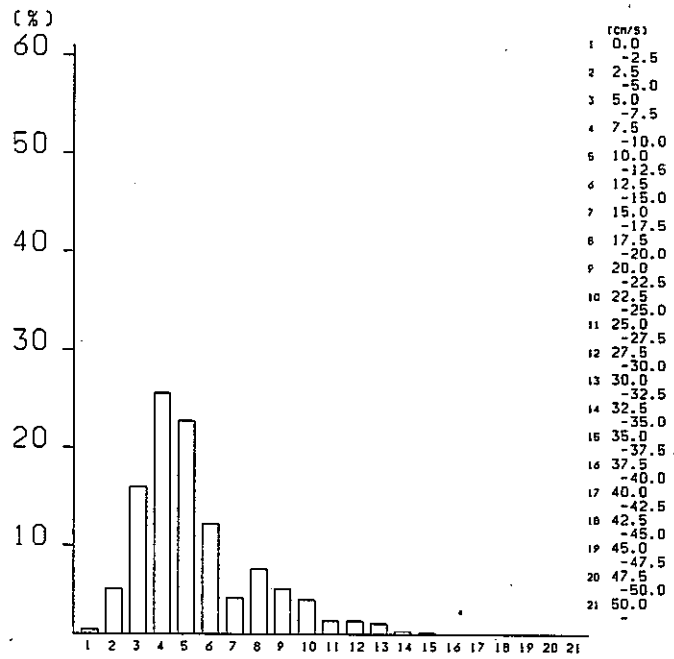
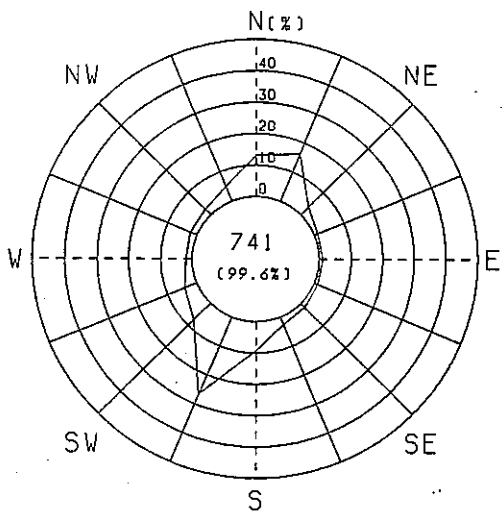

1981/5/1 0:00 - 1981/5/31 23:55

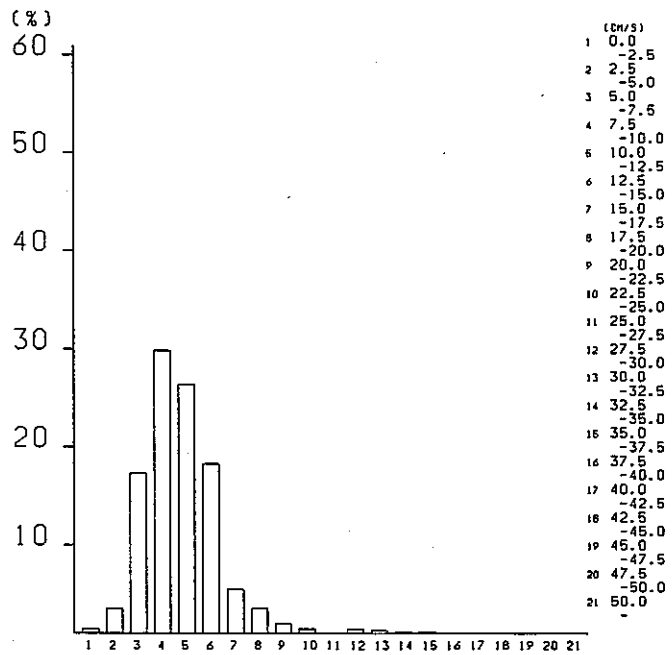
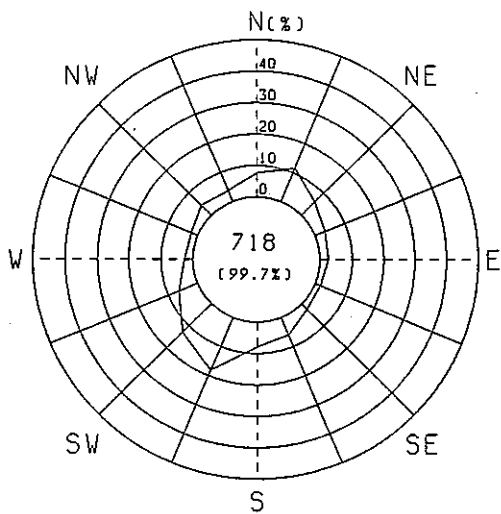

1981/6/1 0:00 - 1981/6/30 23:55

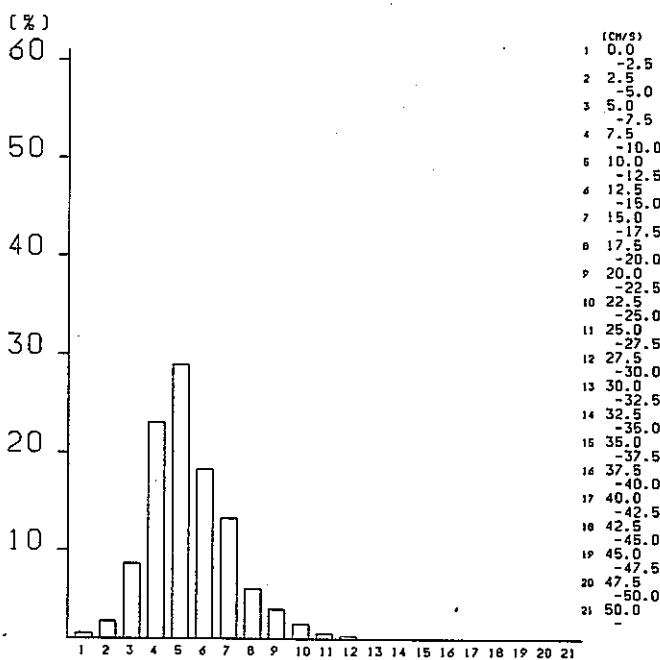
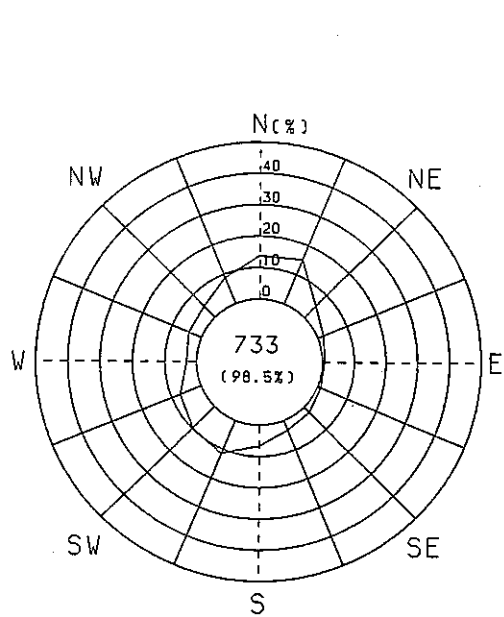

1981/7/1 0:00 - 1981/7/31 23:55

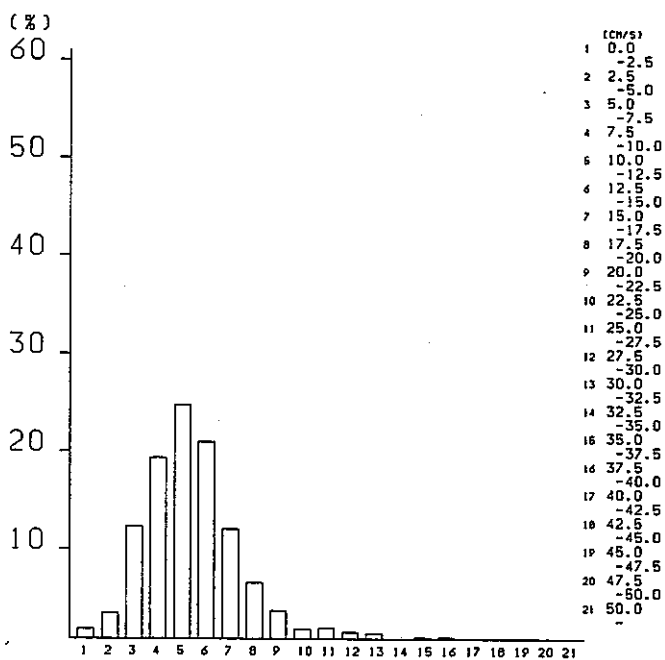
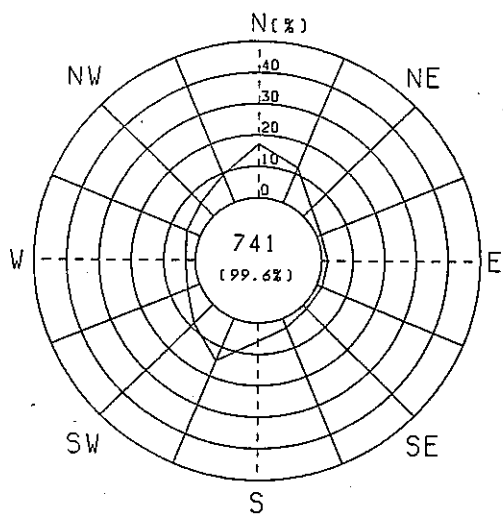

1981/8/1 0:00 - 1981/8/31 23:55

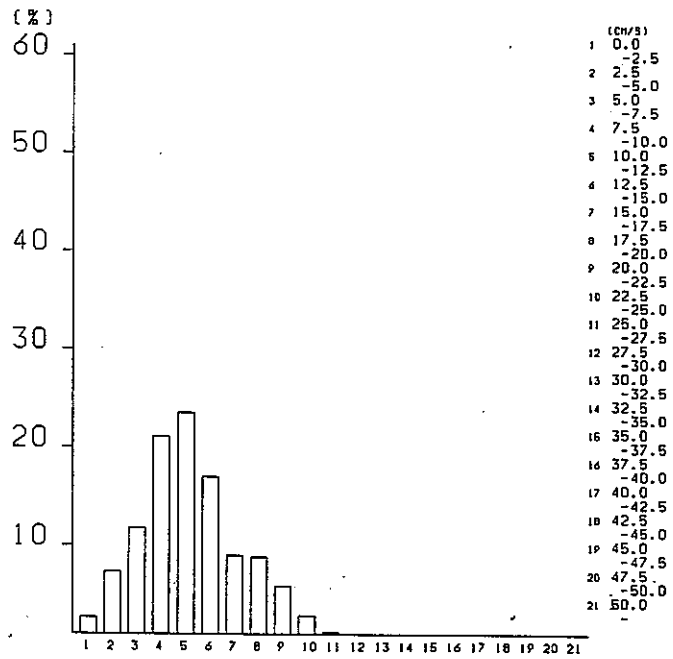
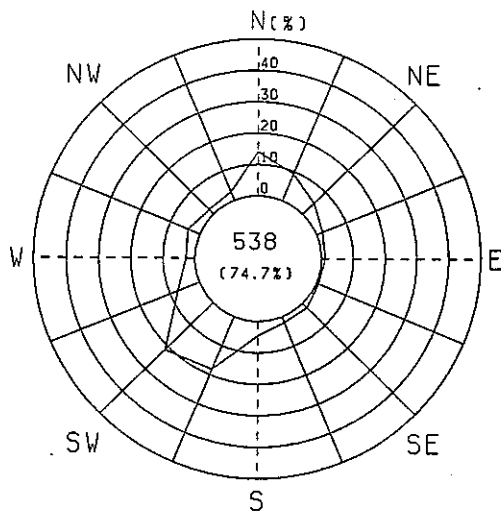

1981/9/1 0:00 - 1981/9/30 23:55

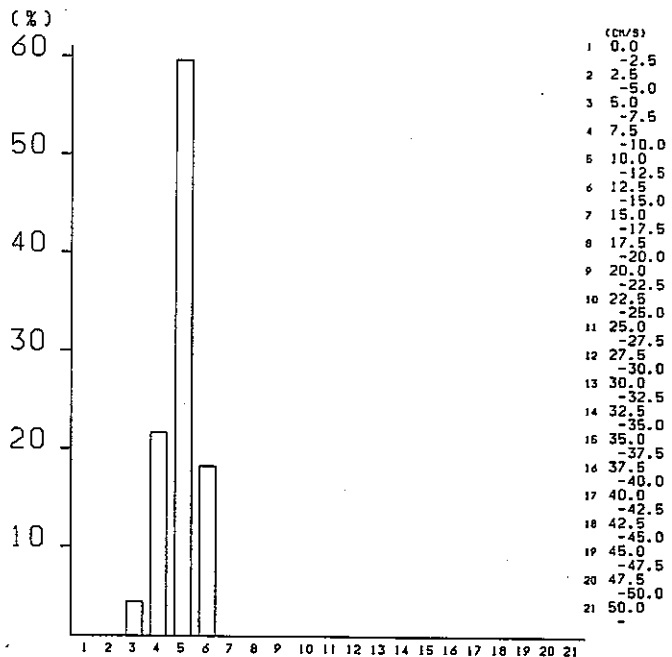
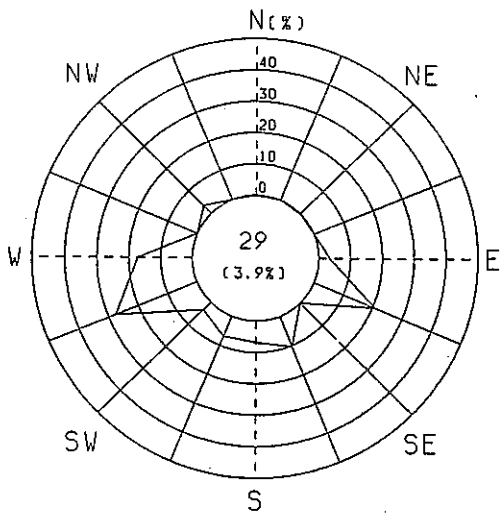

1981/10/1 0:00 - 1981/10/31 23:55

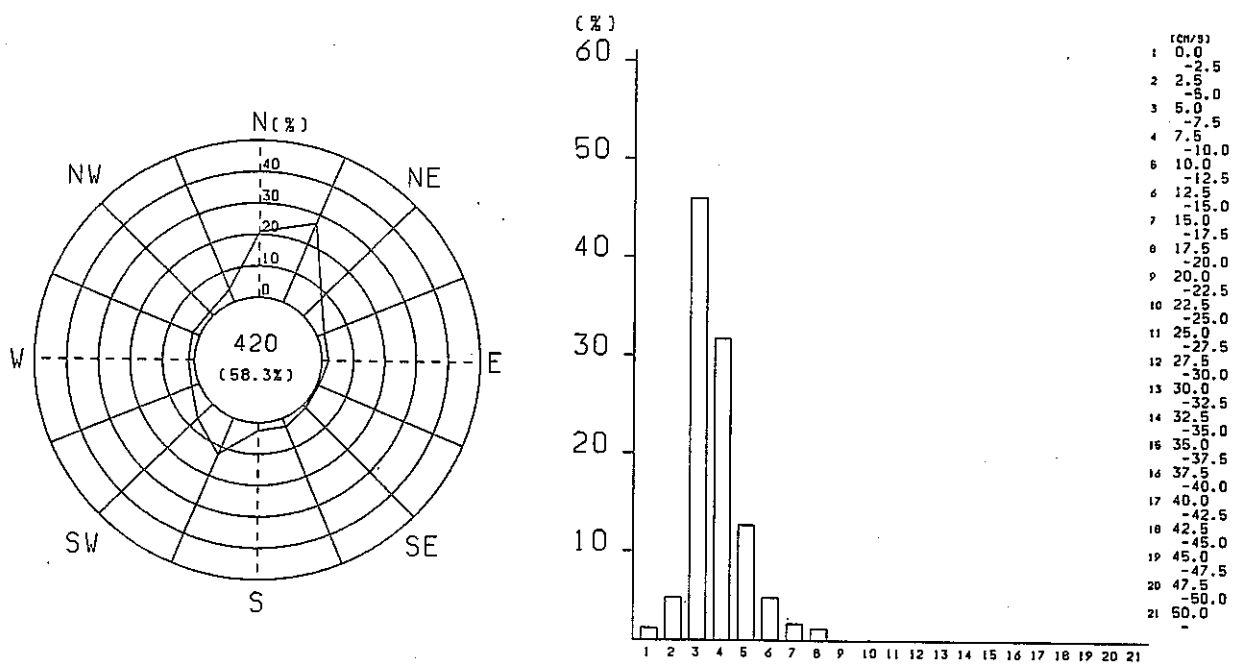

1981/11/1 0:00 - 1981/11/30 23:55

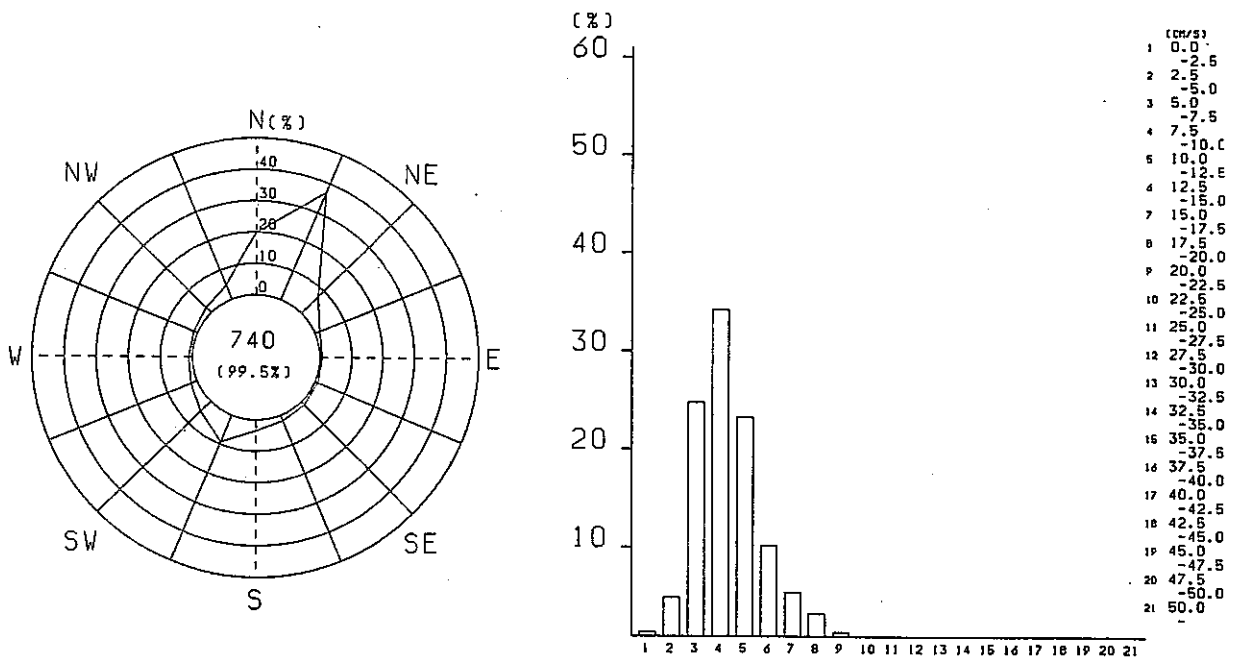

1981/12/1 0:00 - 1981/12/31 23:55

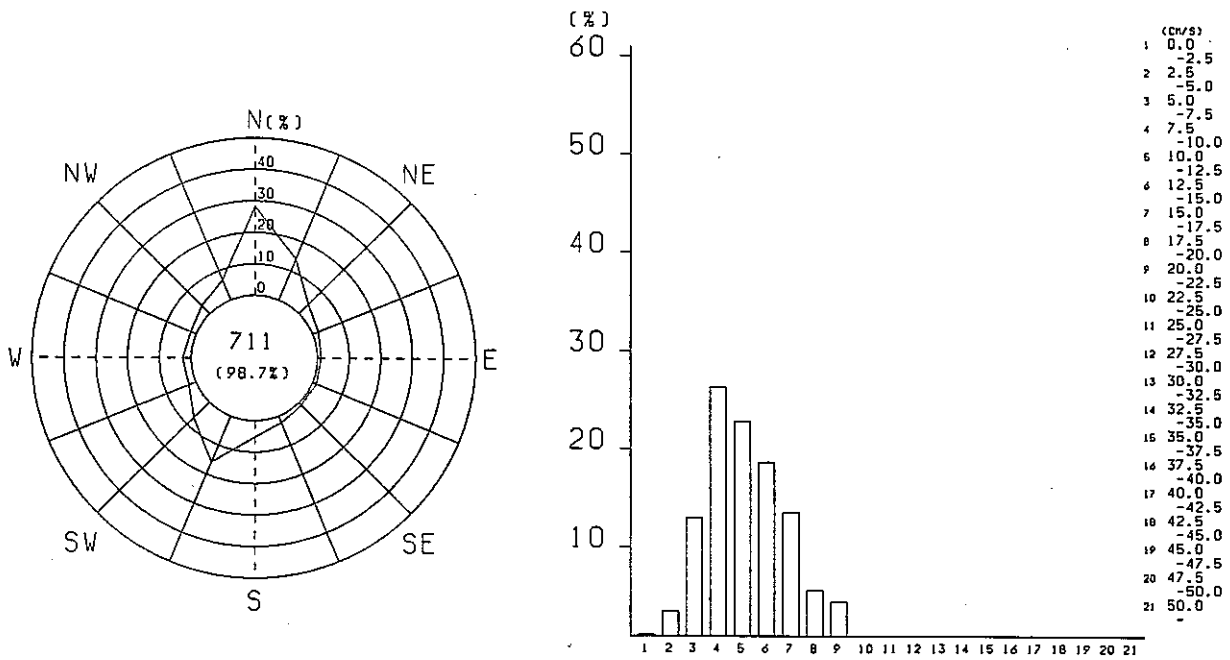

1982/1/2 0:00 - 1982/1/31 23:55

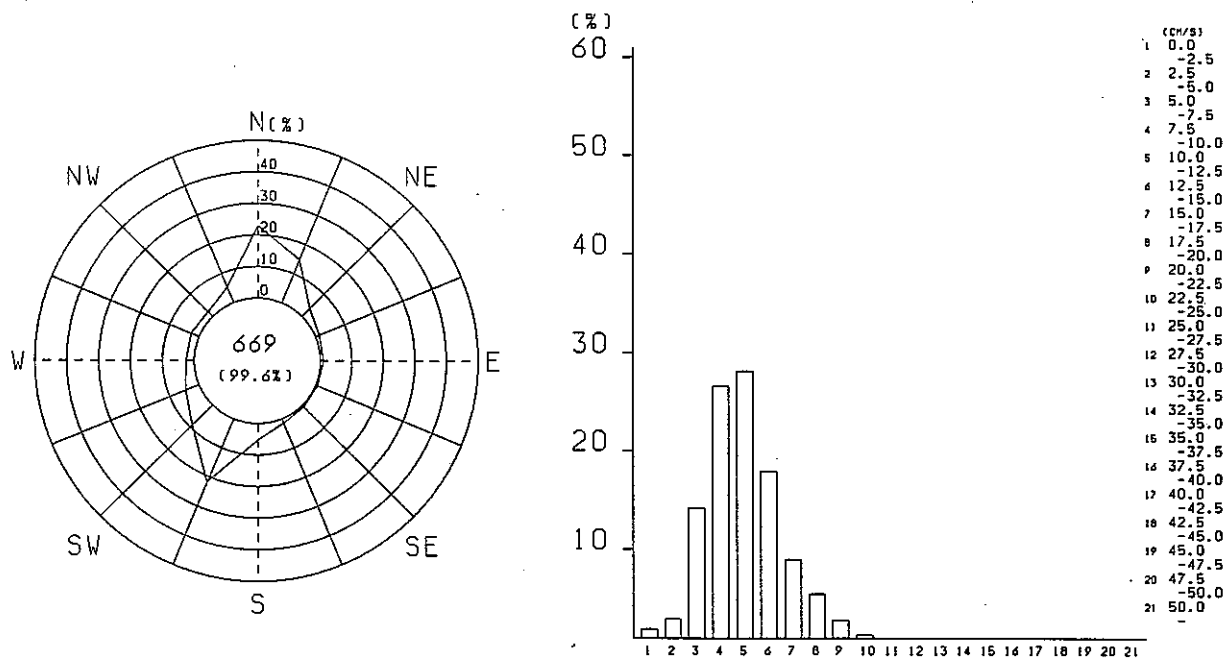

1982/2/1 0:00 - 1982/2/28 23:55

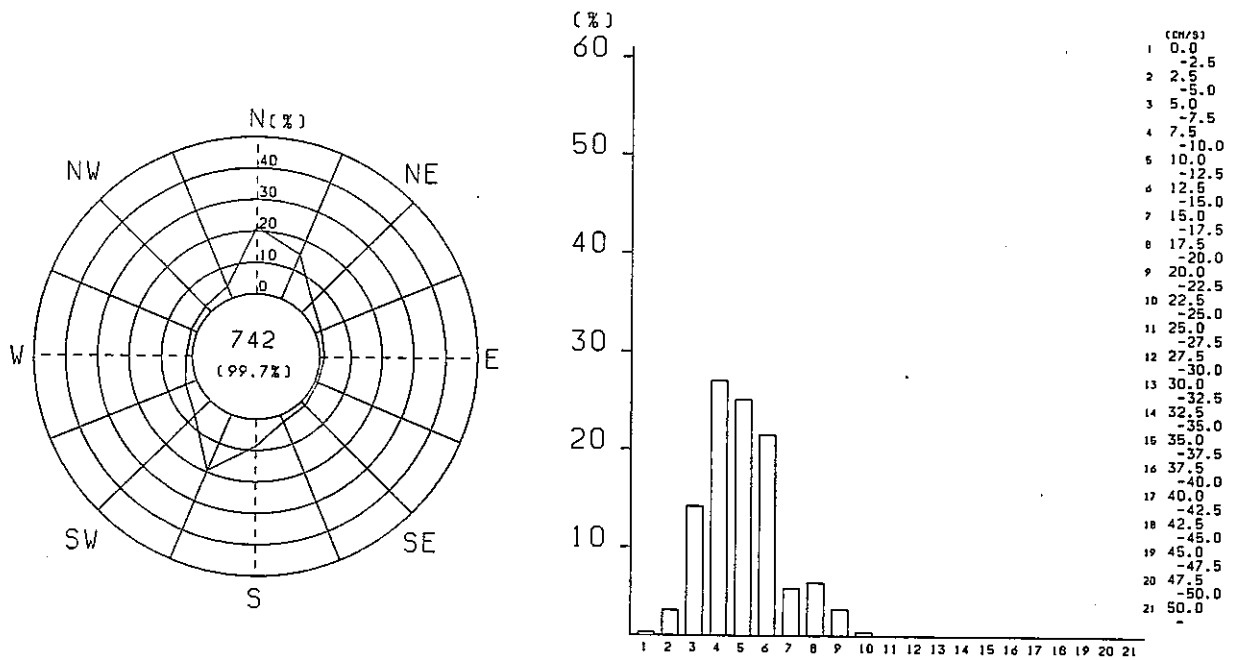

1982/3/1 0:00 - 1982/3/31 23:55

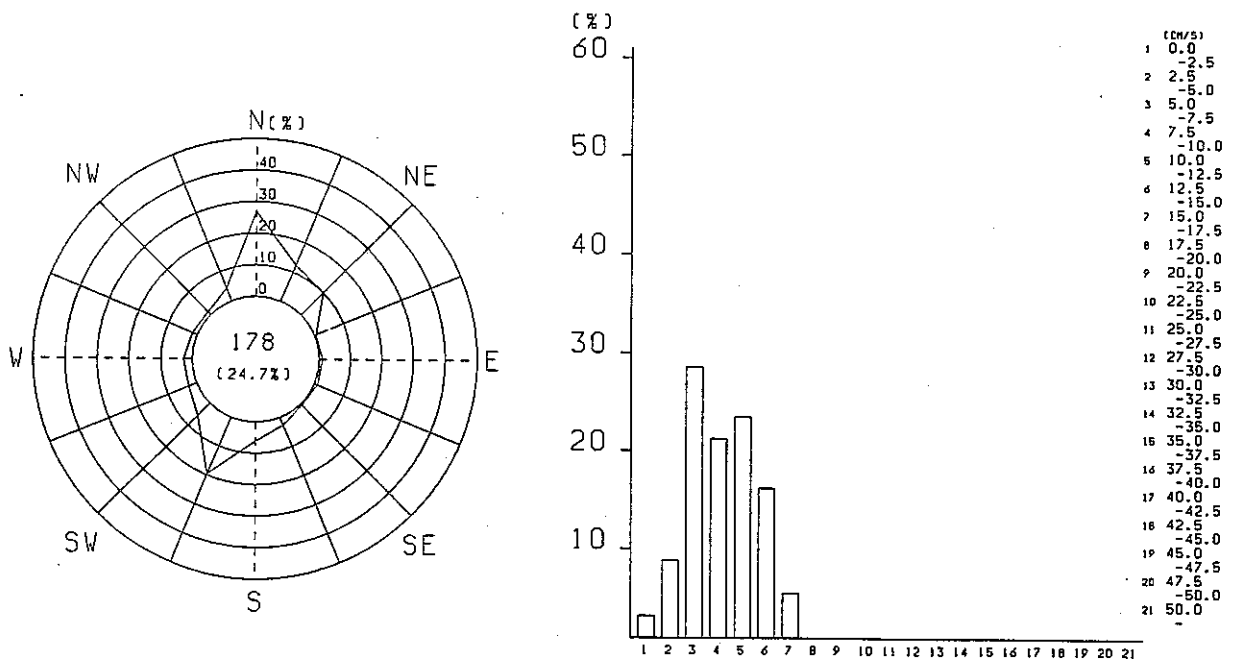

1982/4/1 0:00 - 1982/4/30 23:55

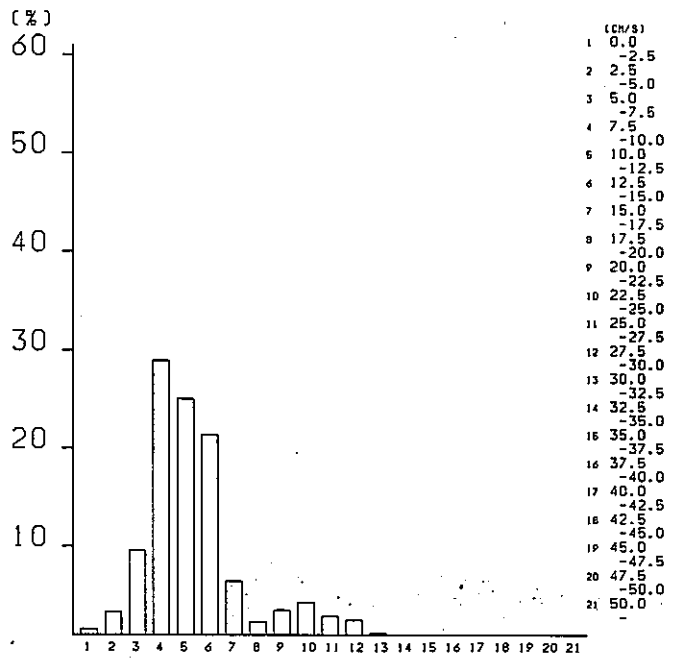
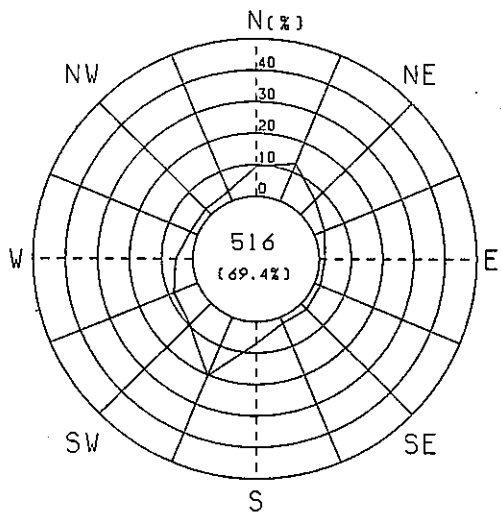

1982/5/1 0:00 - 1982/5/31 23:55

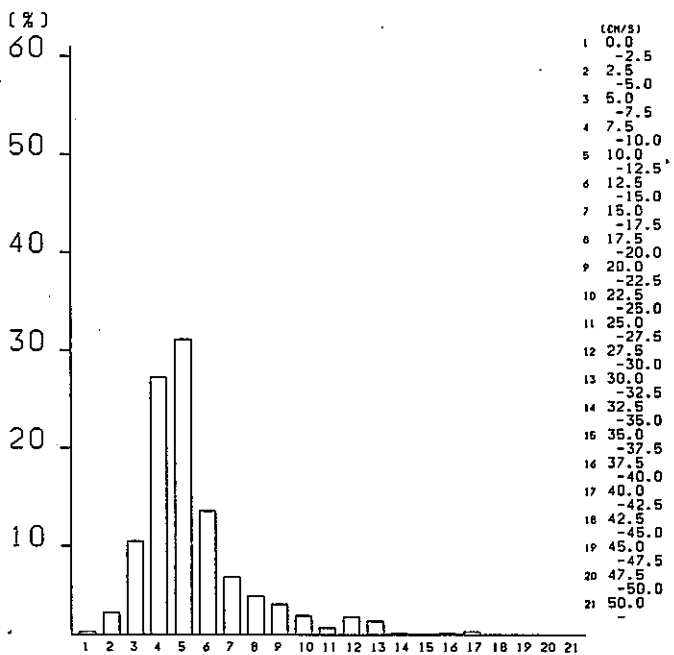
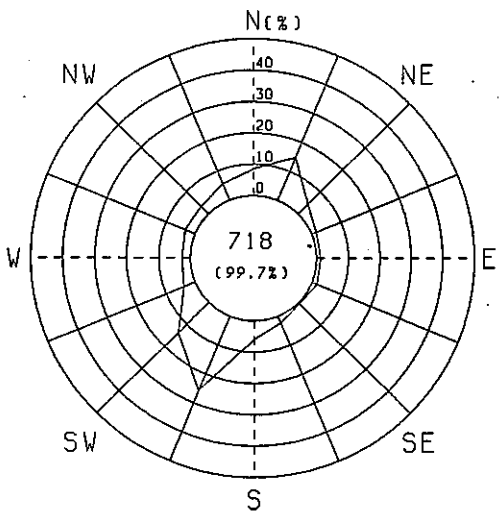

1982/6/1 0:00 - 1982/6/30 23:55

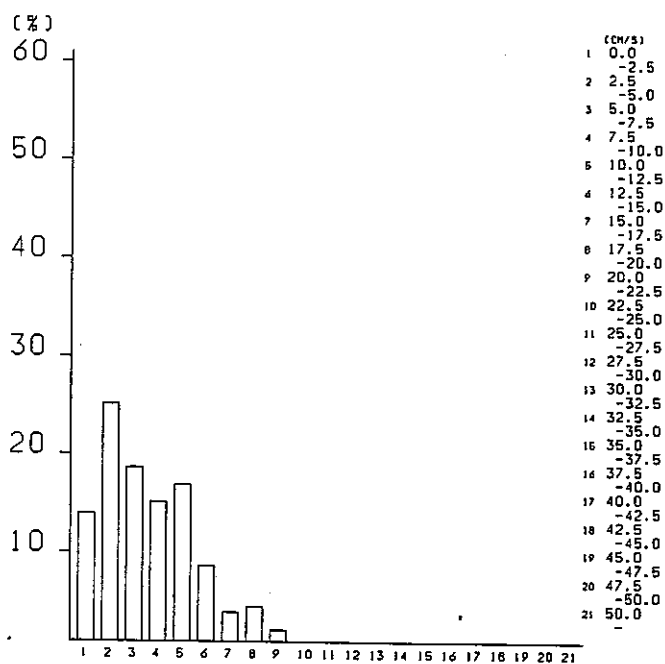
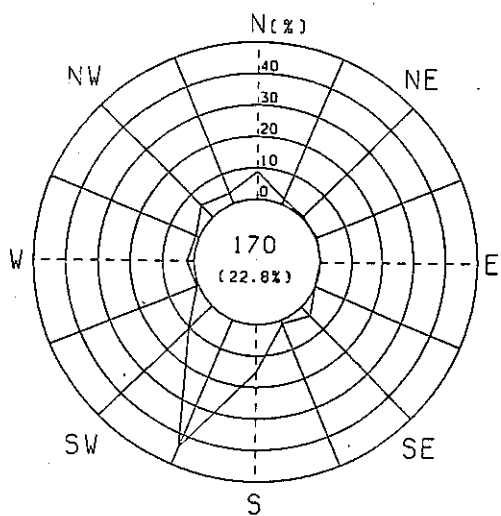

1982/7/1 0:00 - 1982/7/31 23:55

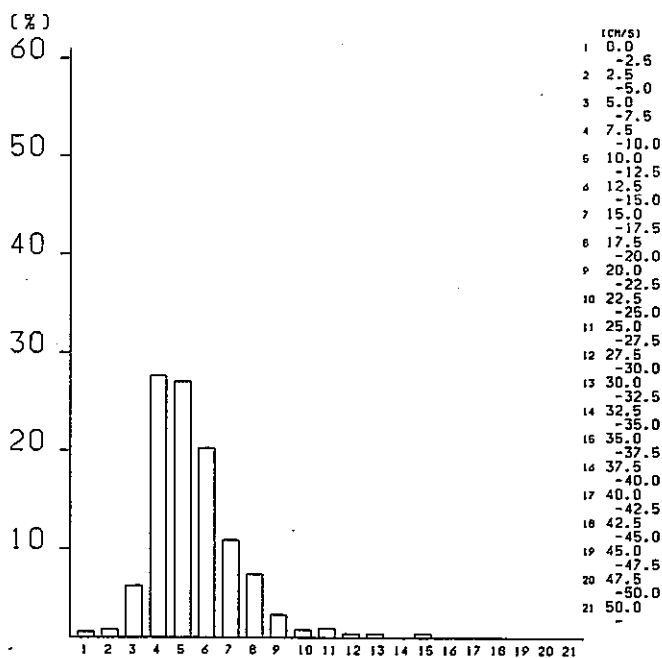
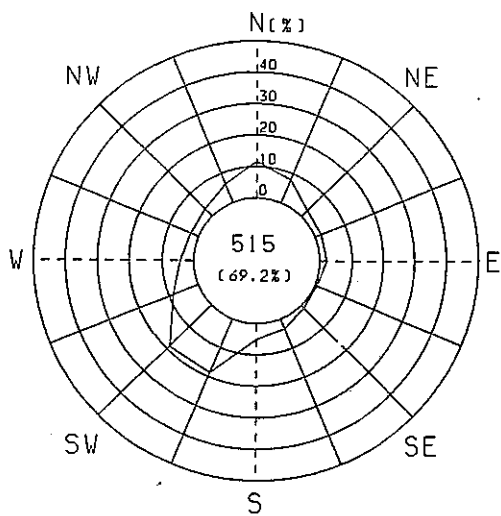

1982/8/1 0:00 - 1982/8/31 23:55

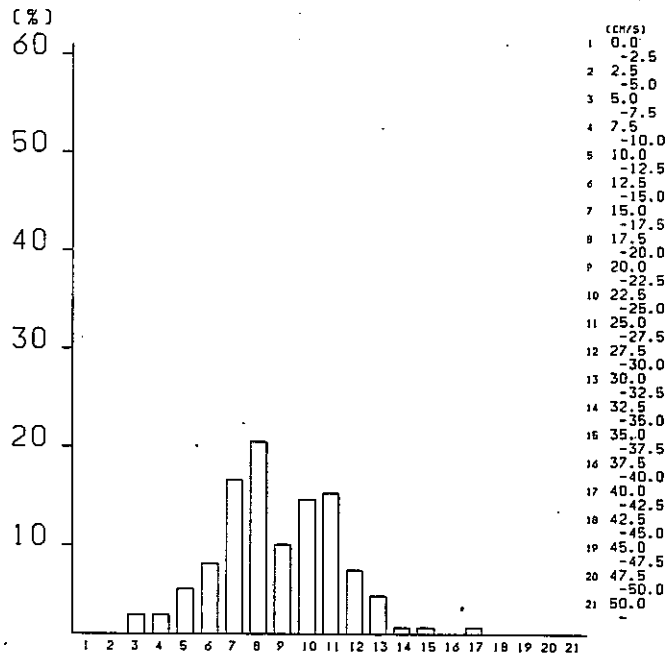
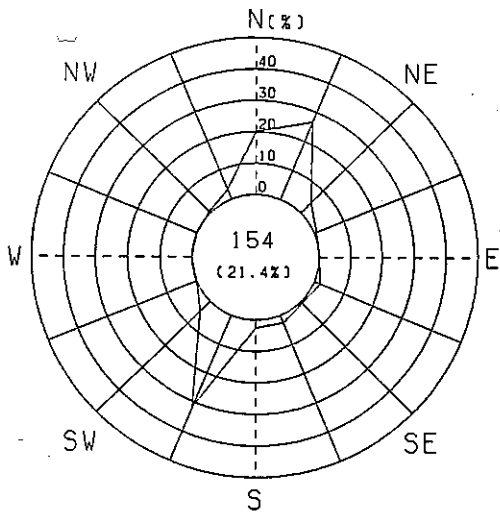

1982/9/1 0:00 - 1982/9/30 23:55

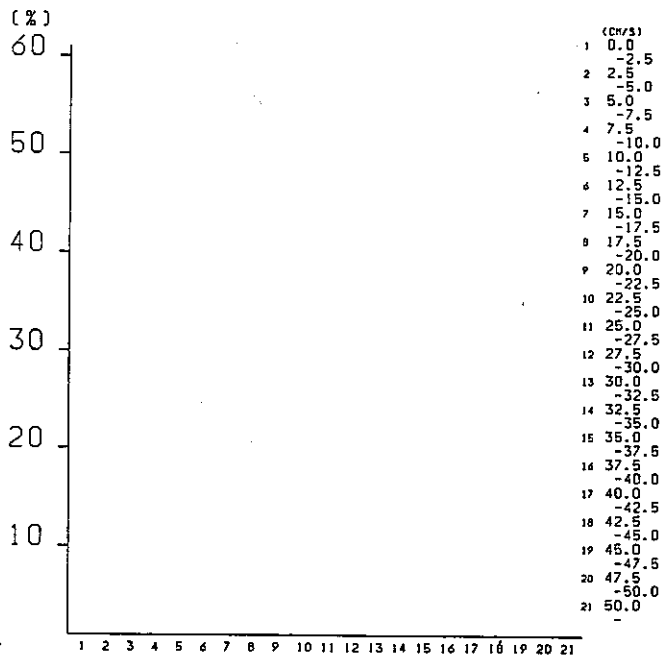
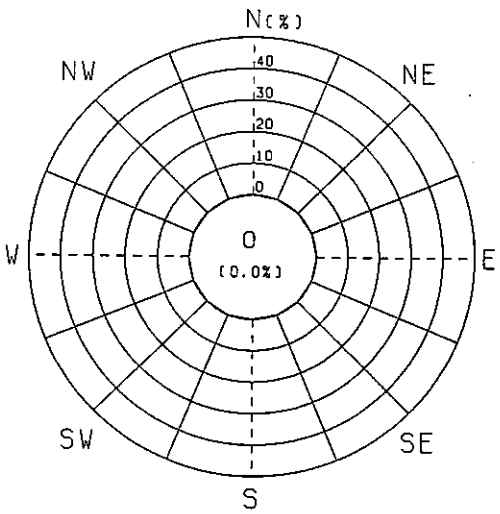

1982/10/1 0:00 - 1982/10/31 23:55

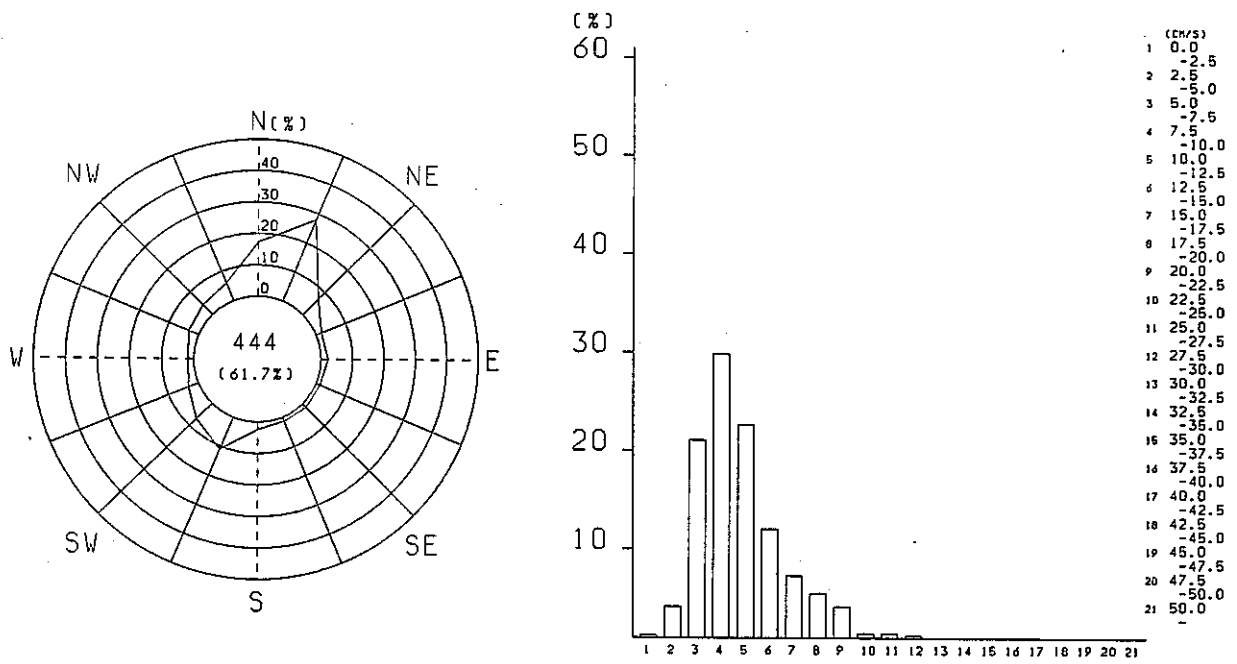

1982/11/1 0:00 - 1982/11/30 23:55

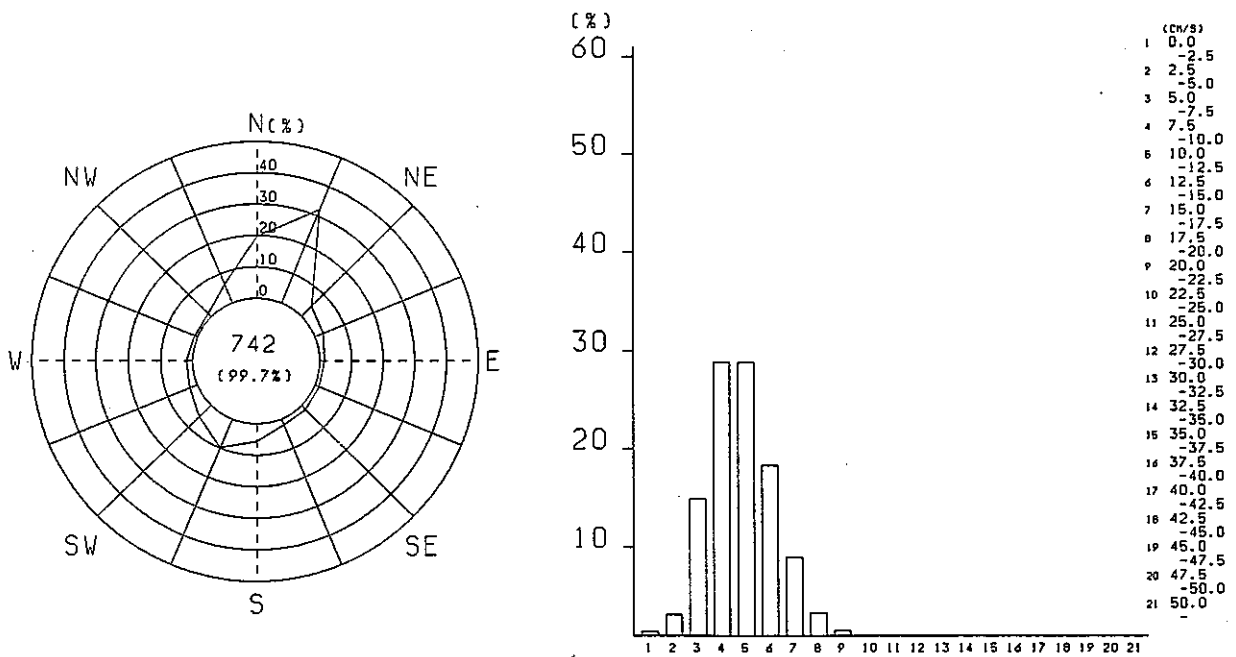

1982/12/1 0:00 - 1982/12/31 23:55

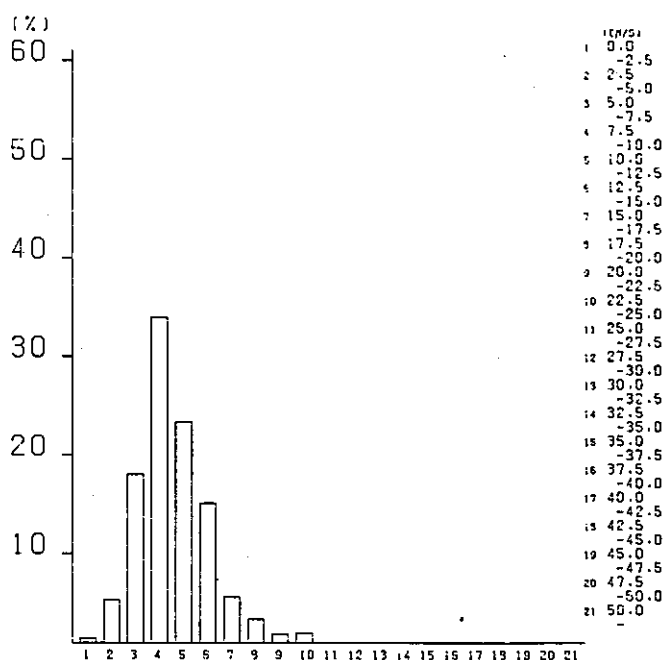
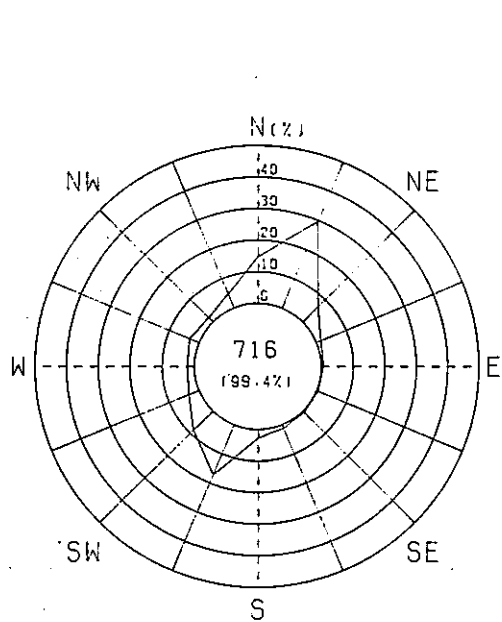

1983/1/2 0:00 - 1983/1/31 23:55

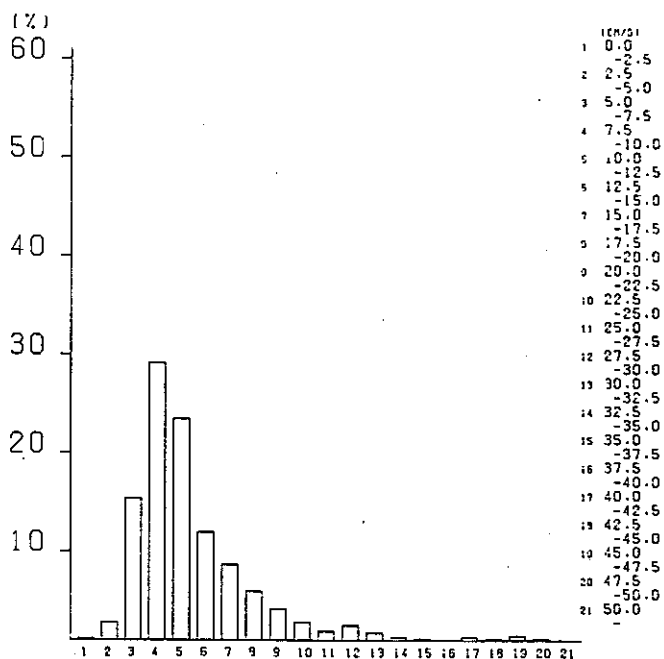
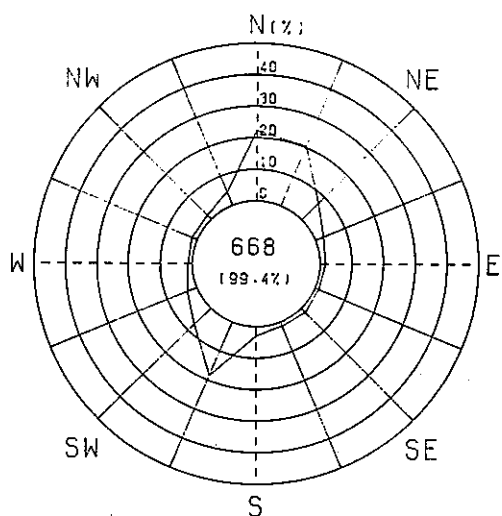

1983/2/1 0:00 - 1983/2/28 23:55

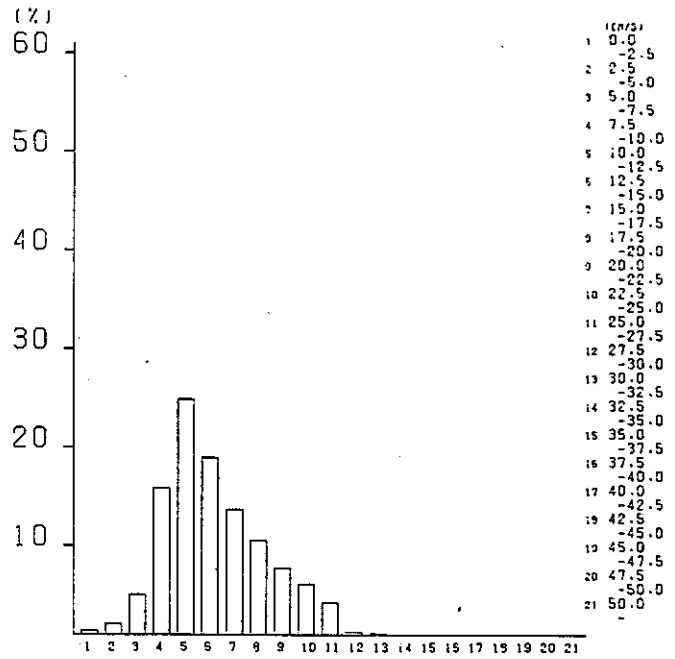
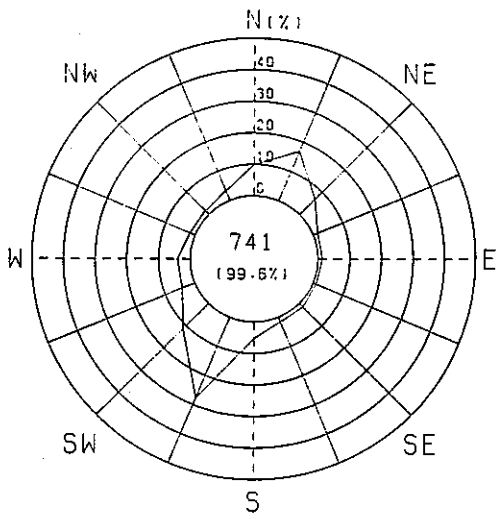

1983/3/1 0:00 - 1983/3/31 23:55

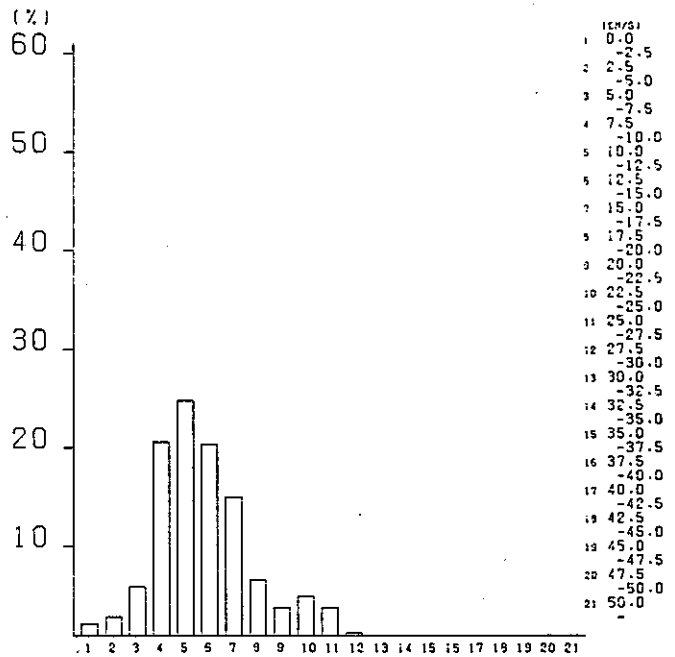
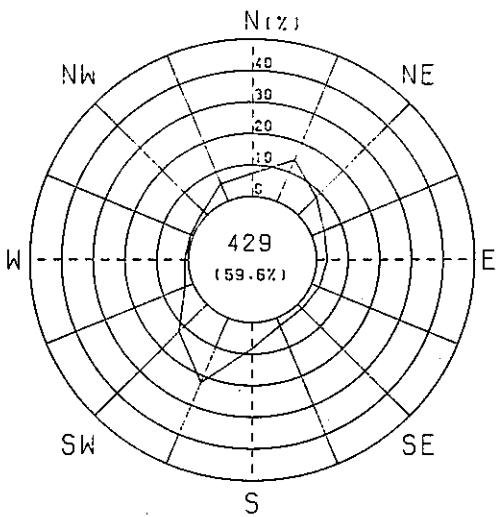

1983/4/1 0:00 - 1983/4/30 23:55

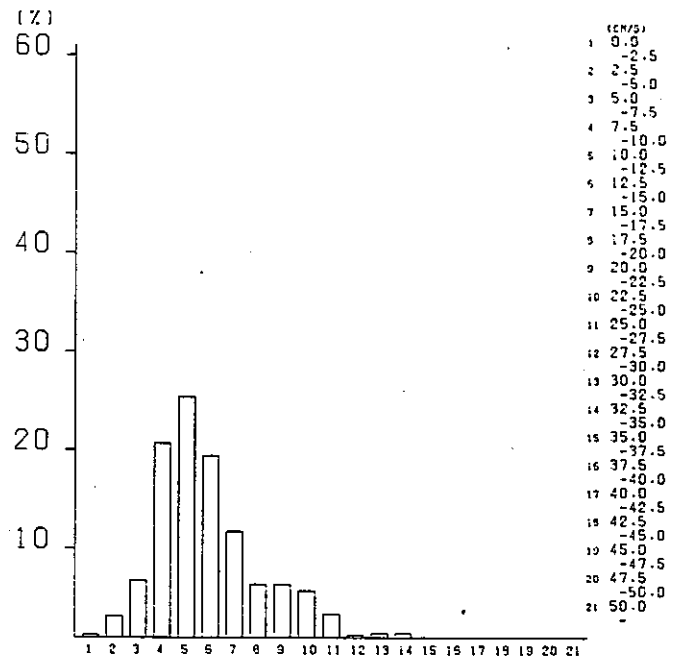
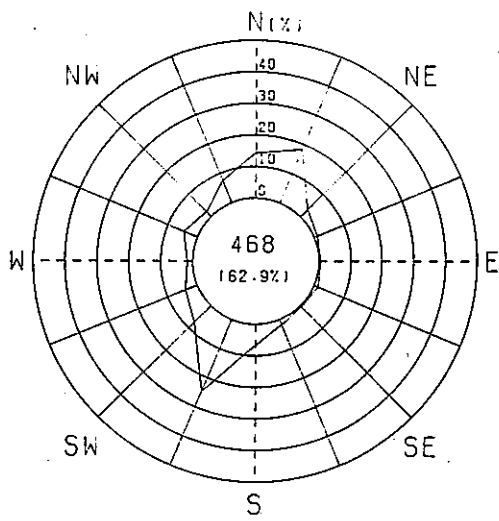

1983/5/1 0:00 - 1983/5/31 23:55

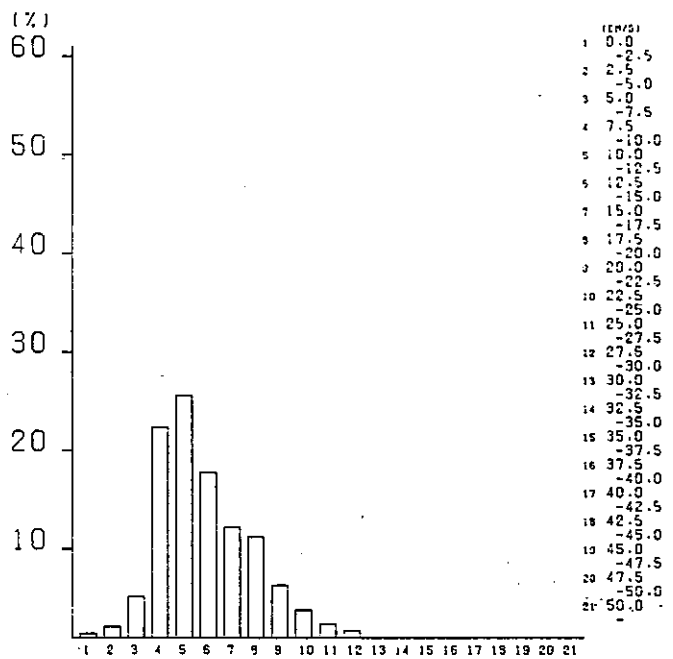
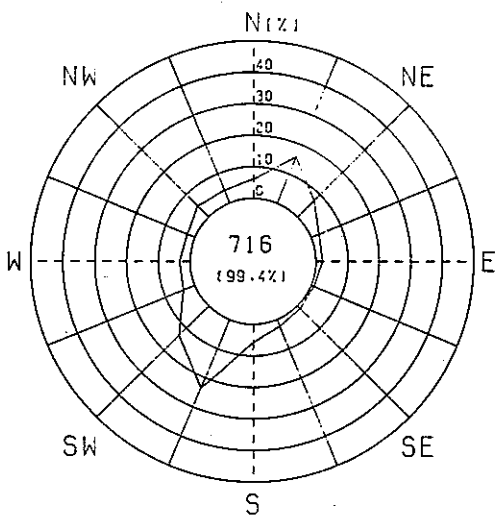

1983/6/1 0:00 - 1983/6/30 23:55

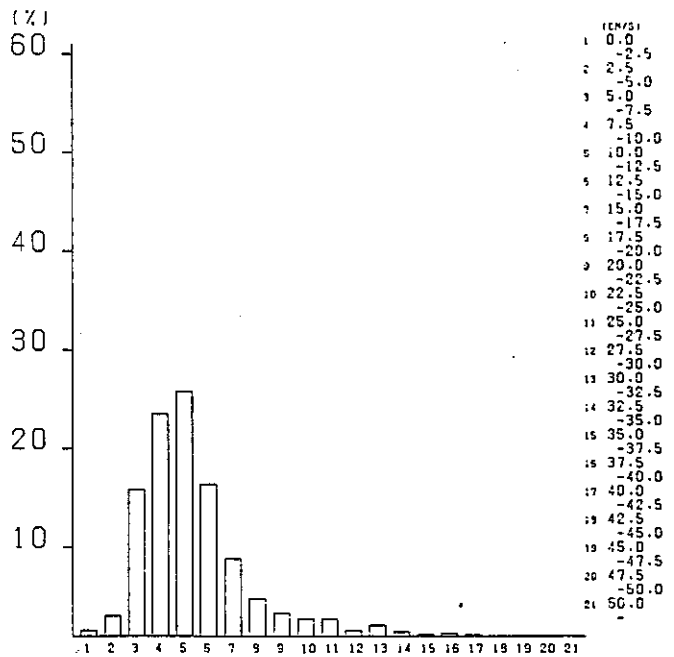
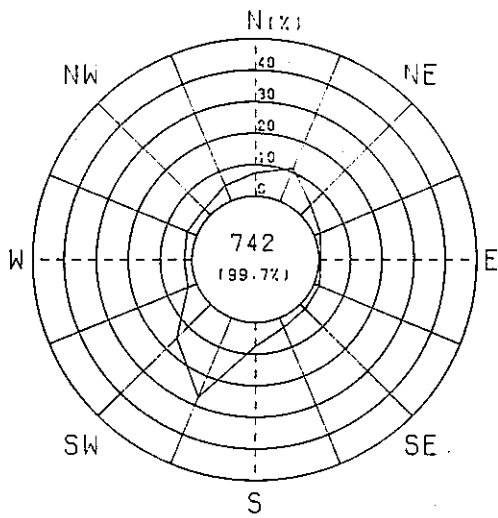

1983/7/1 0:00 - 1983/7/31 23:55

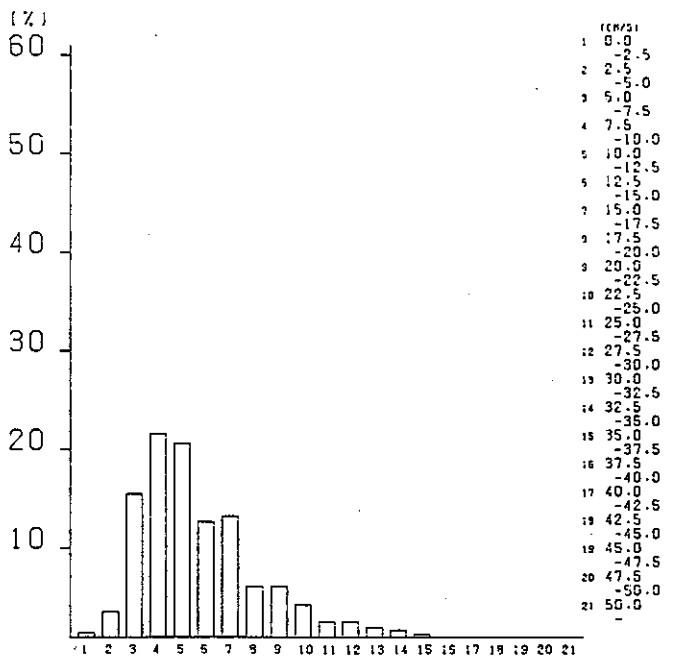
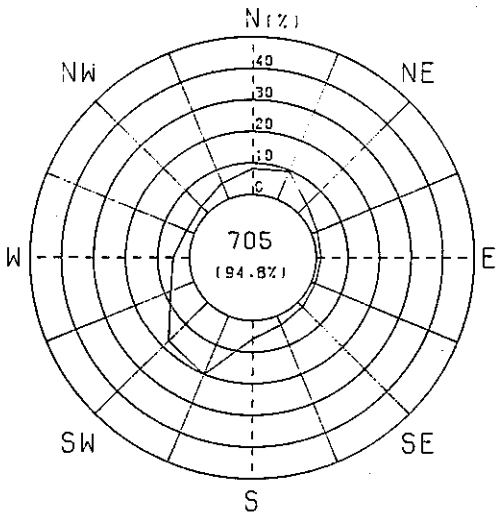

1983/8/1 0:00 - 1983/8/31 23:55

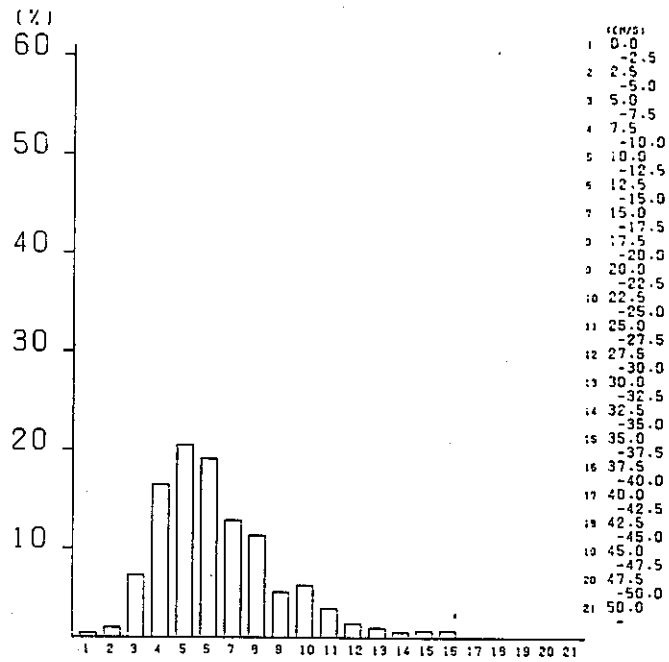
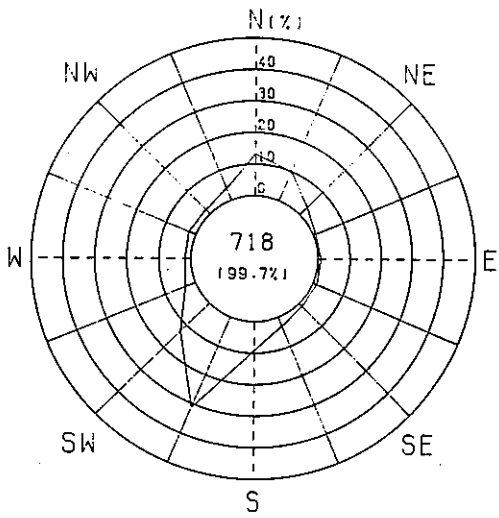

1983/9/1 0:00 - 1983/9/30 23:55

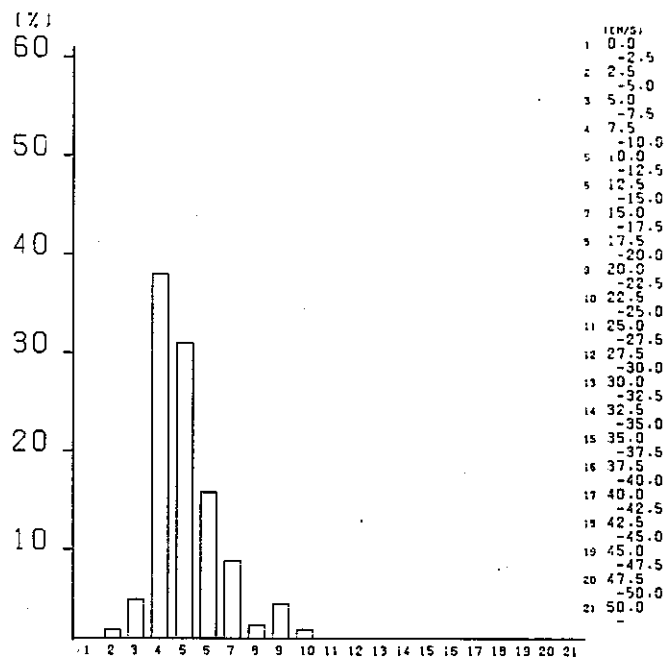
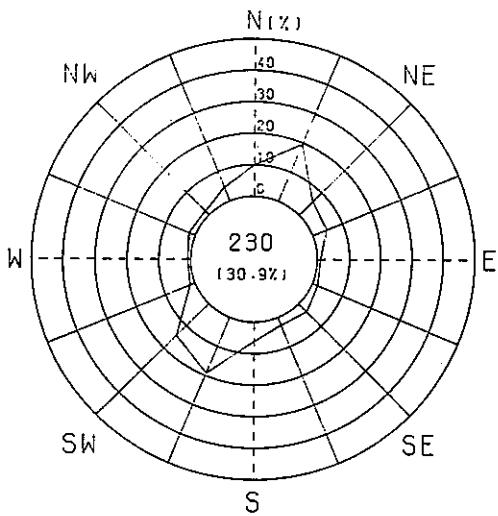

1983/10/1 0:00 - 1983/10/31 23:55

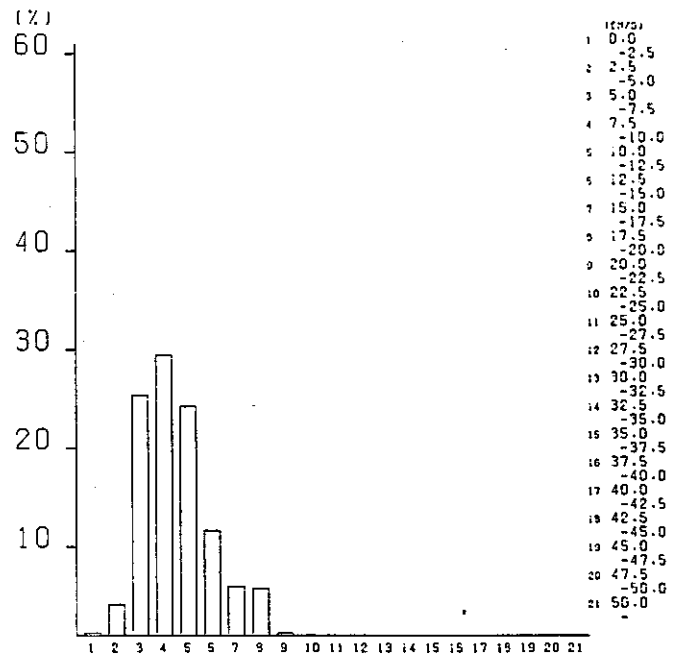
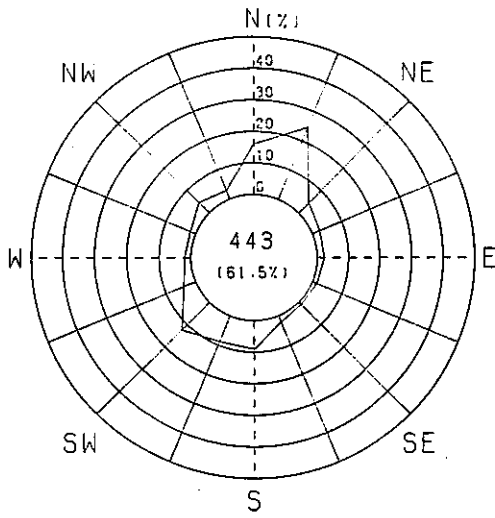

1983/11/1 0:00 - 1983/11/30 23:55

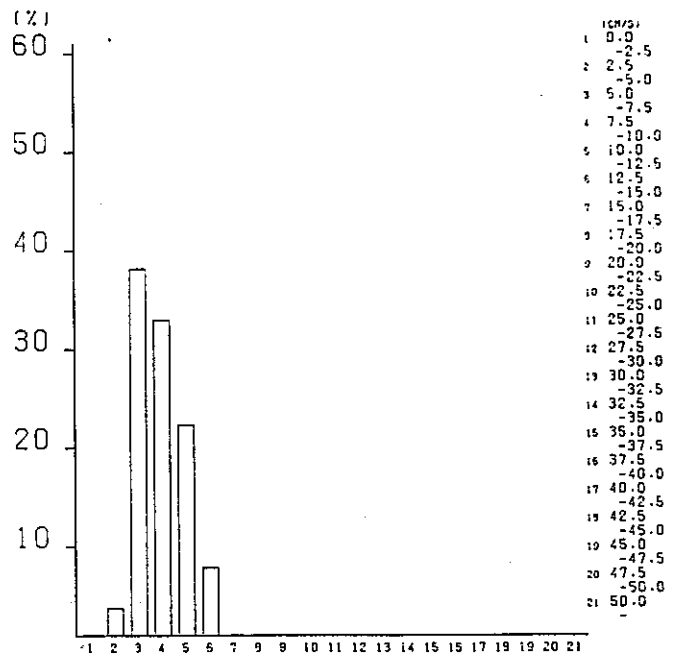
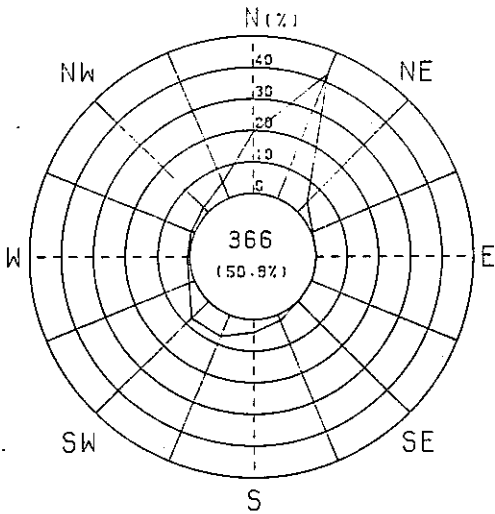

1983/12/1 0:00 - 1983/12/31 23:55

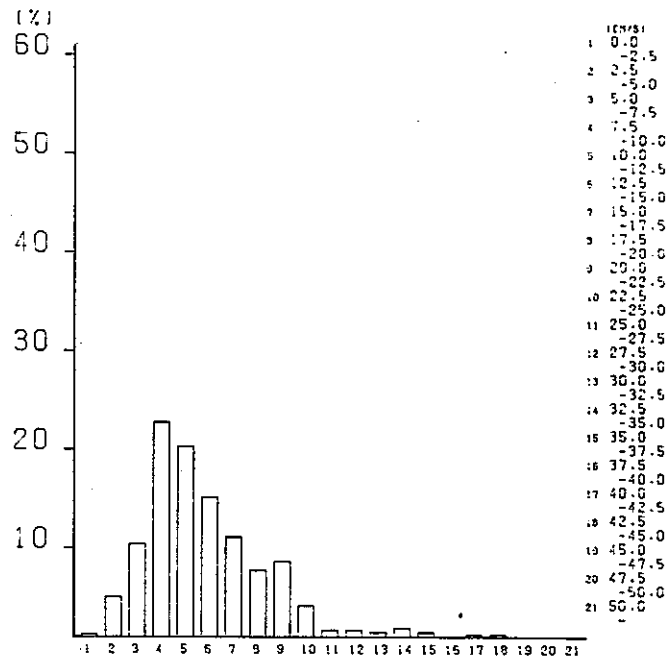
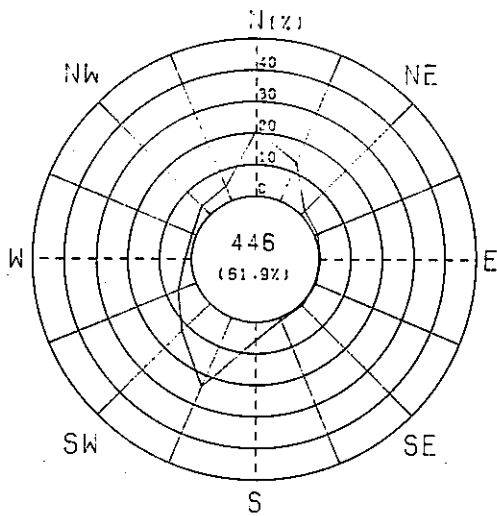

1984/1/2 0:00 - 1984/1/31 23:55

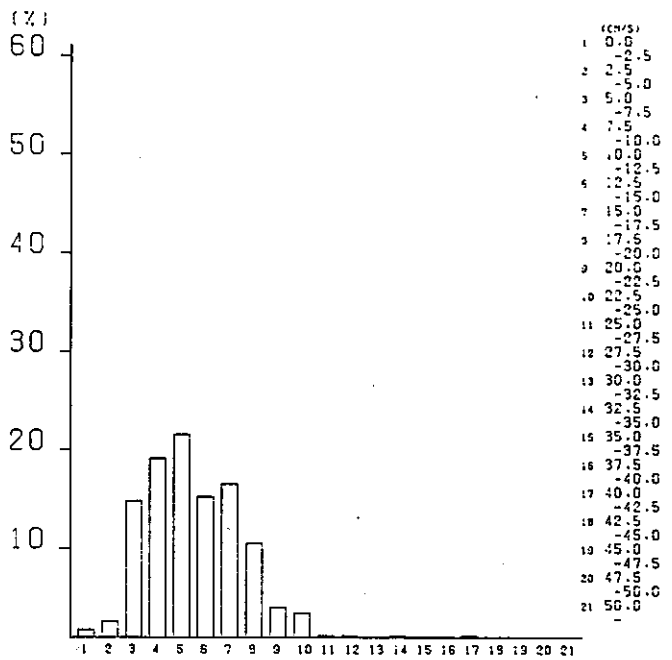
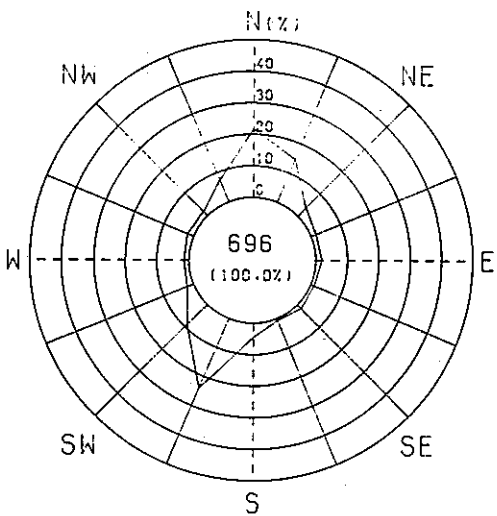

1984/2/1 0:00 - 1984/2/28 23:55

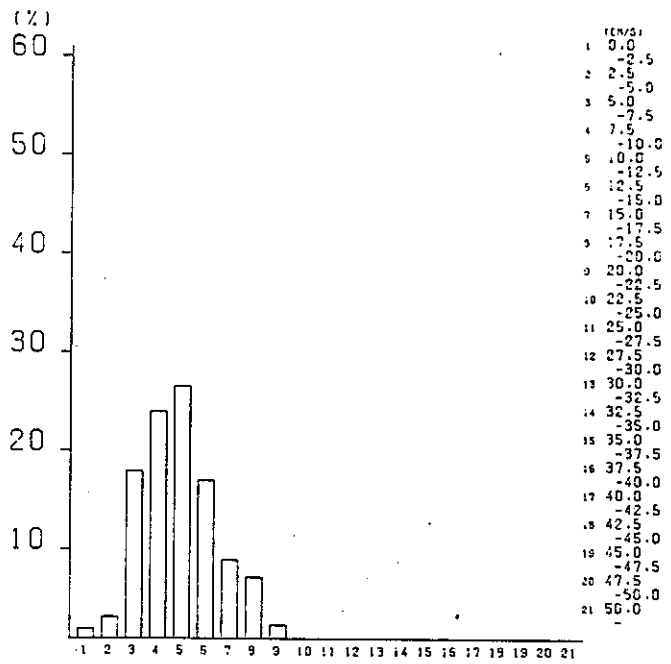
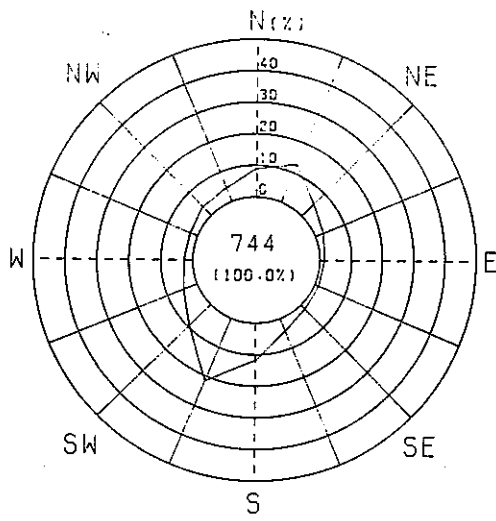

1984/3/1 0:00 - 1984/3/31 23:55

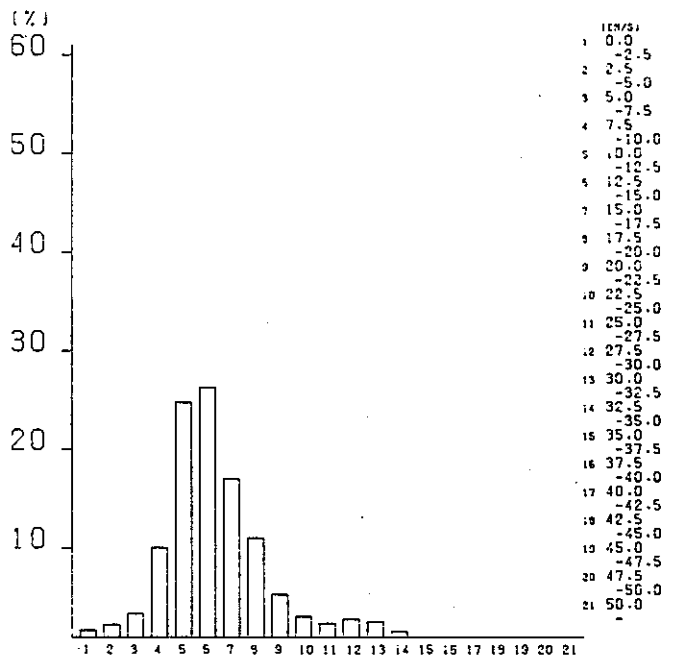
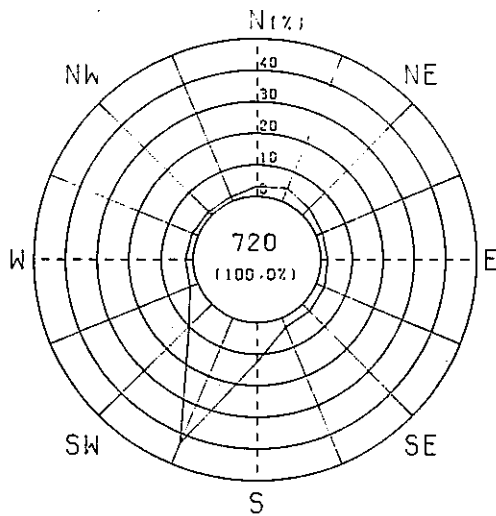

1984/4/1 0:00 - 1984/4/30 23:55

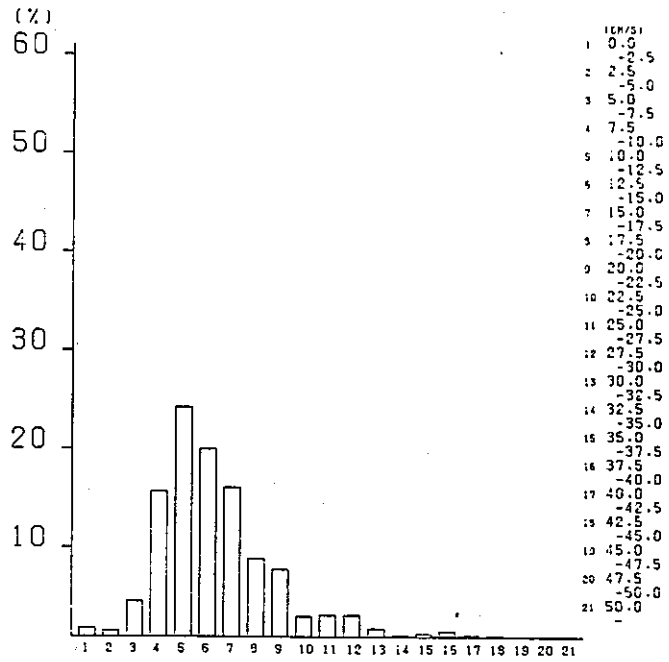
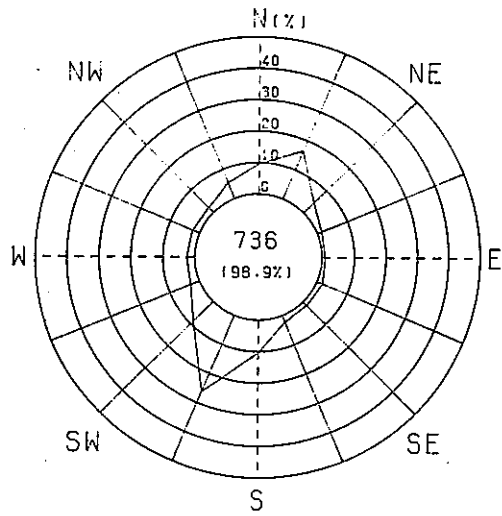

1984/5/1 0:00 - 1984/5/31 23:55

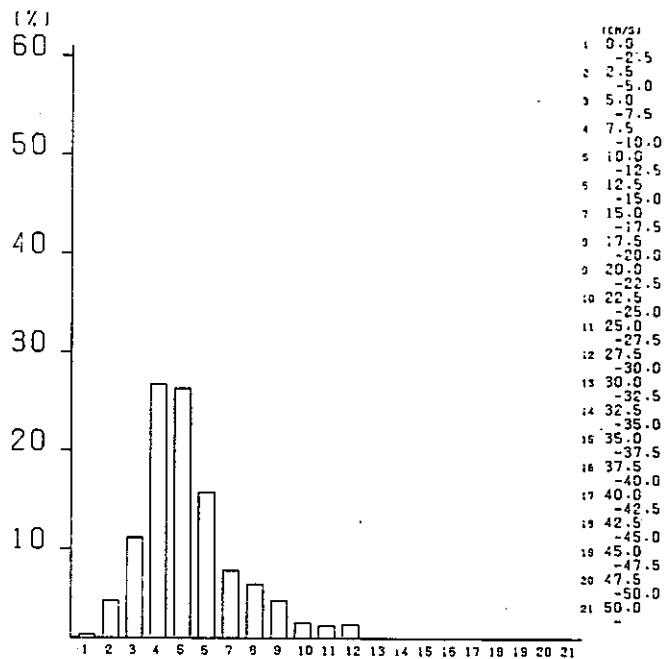
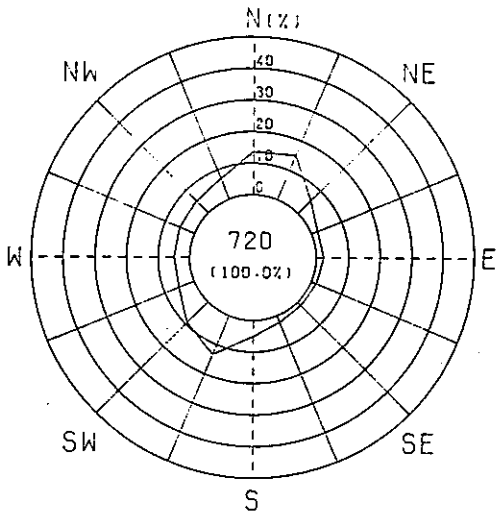

1984/6/1 0:00 - 1984/6/30 23:55

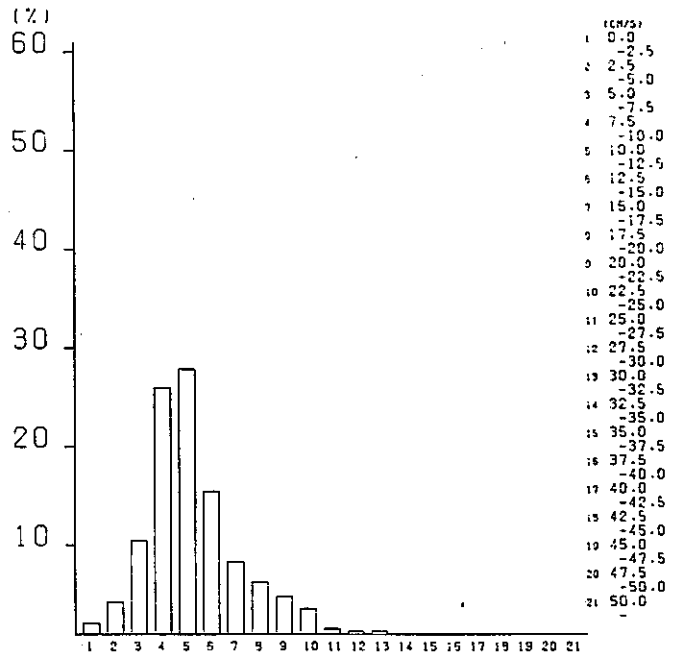
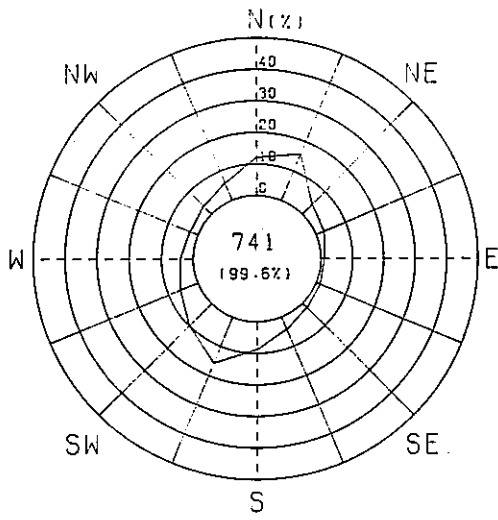

1984/7/1 0:00 - 1984/7/31 23:55

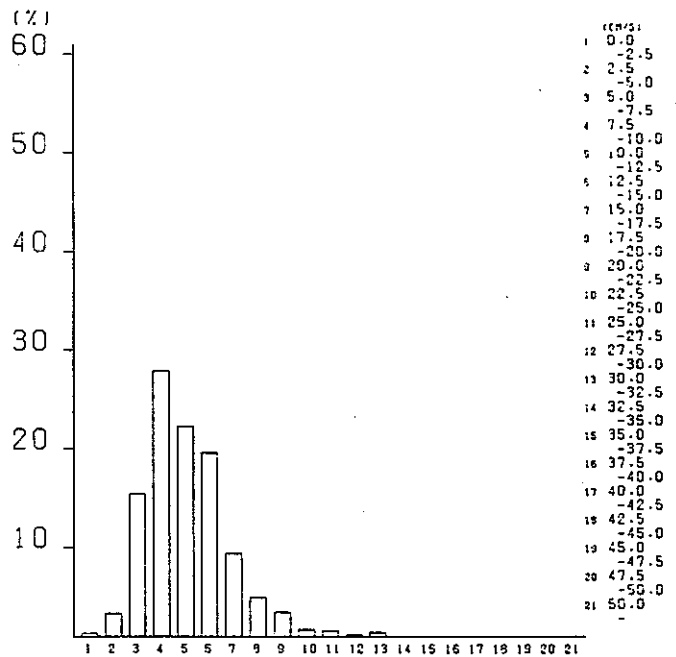
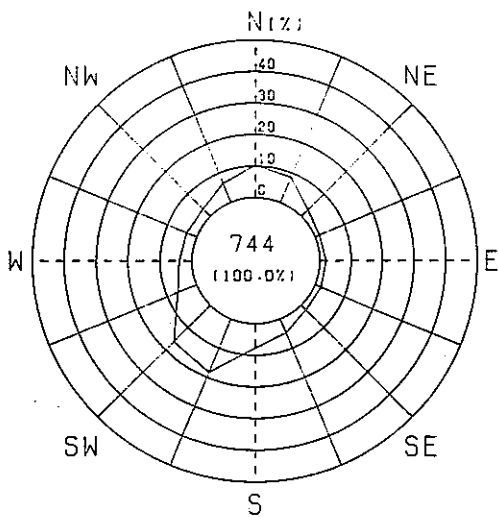

1984/8/1 0:00 - 1984/8/31 23:55

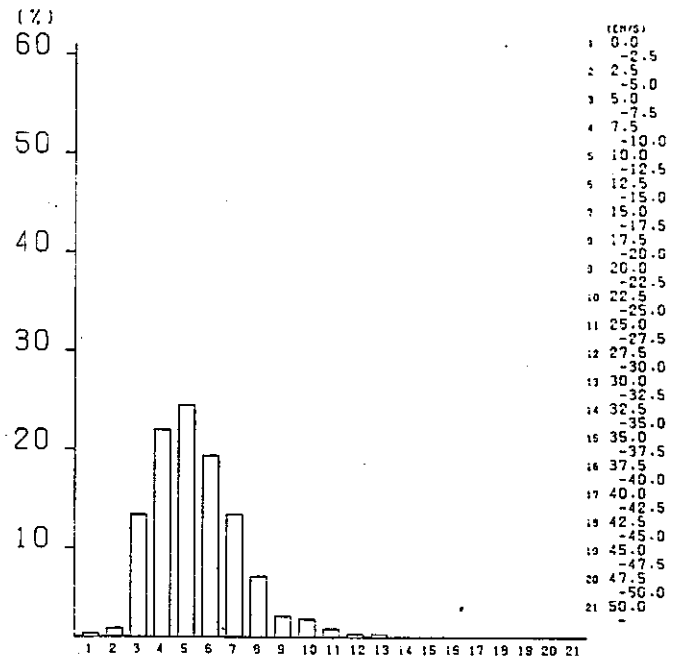
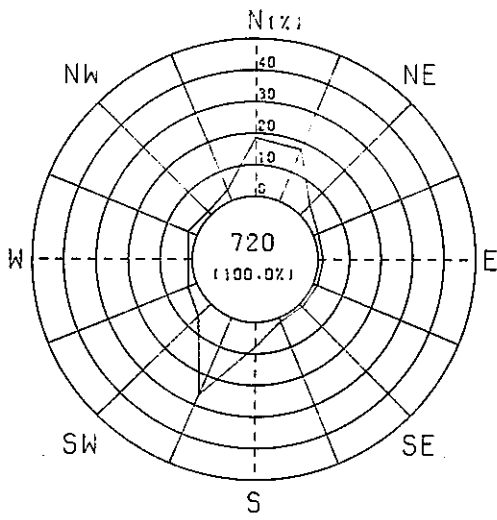

1984/9/1 0:00 - 1984/9/30 23:55

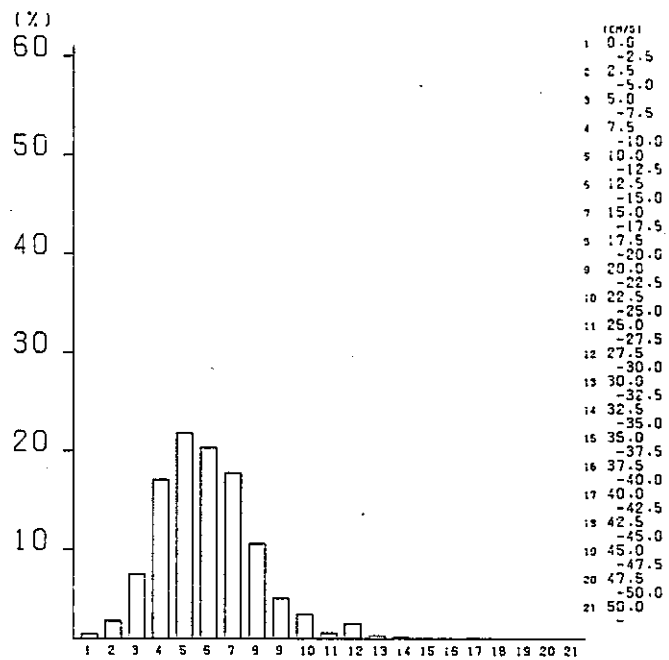
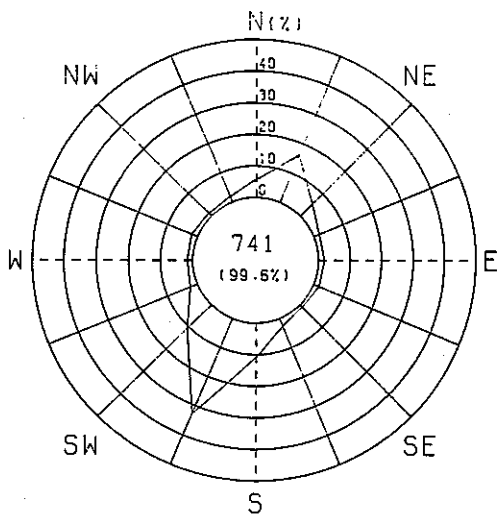

1984/10/1 0:00 - 1984/10/31 23:55

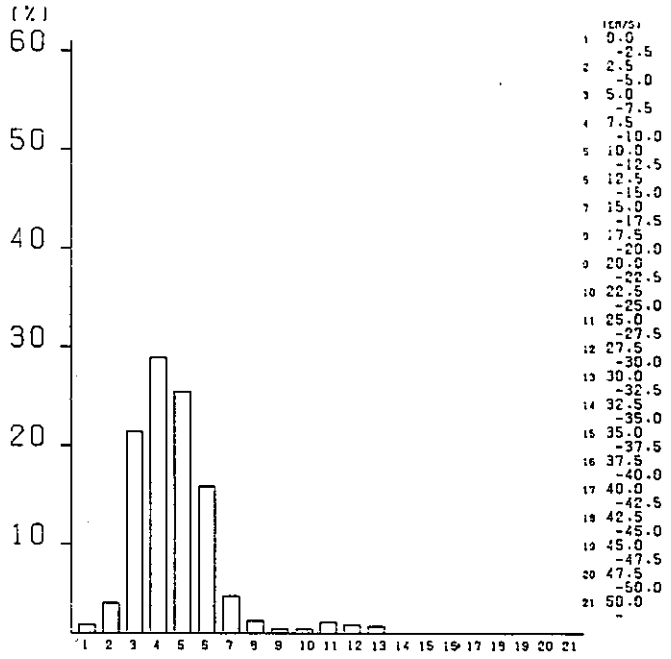
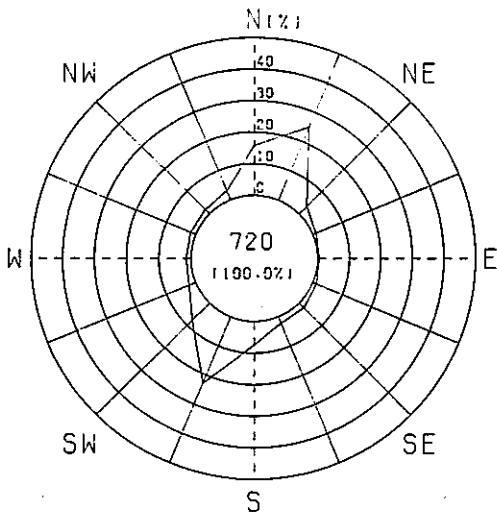

1984/11/1 0:00 - 1984/11/30 23:55

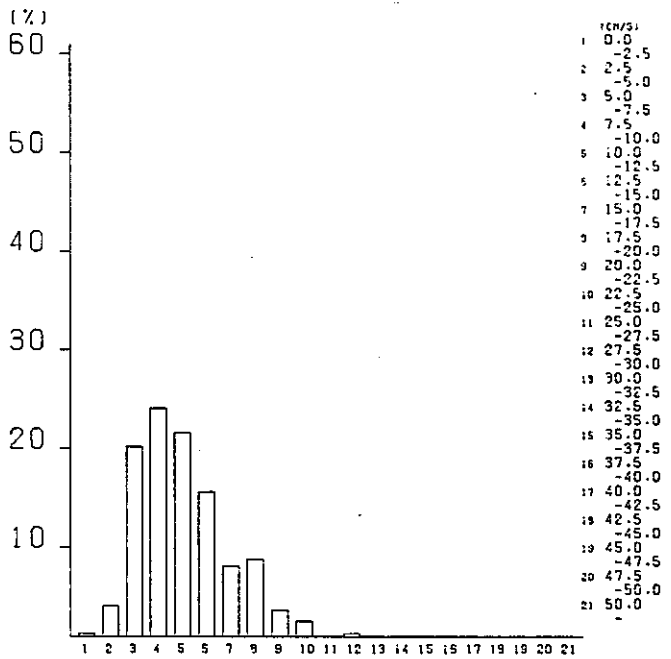
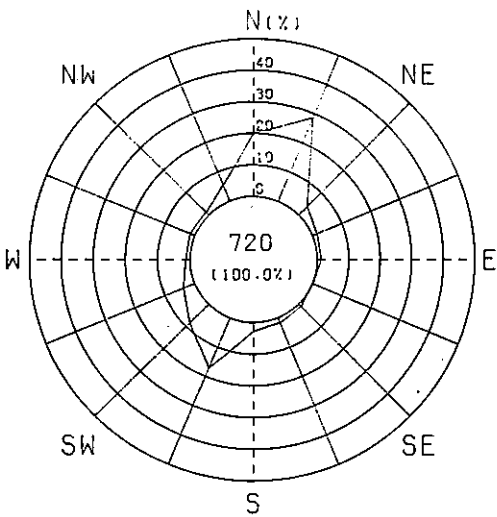

1984/12/1 0:00 - 1984/12/31 23:55

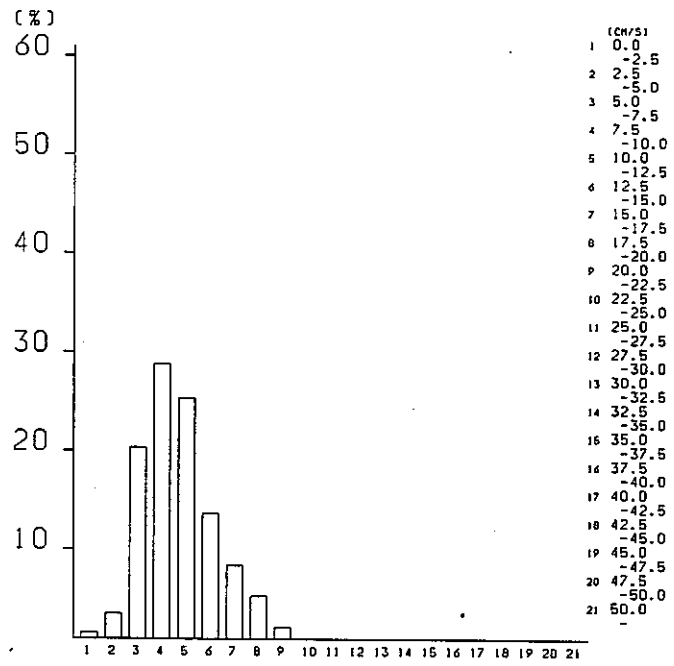
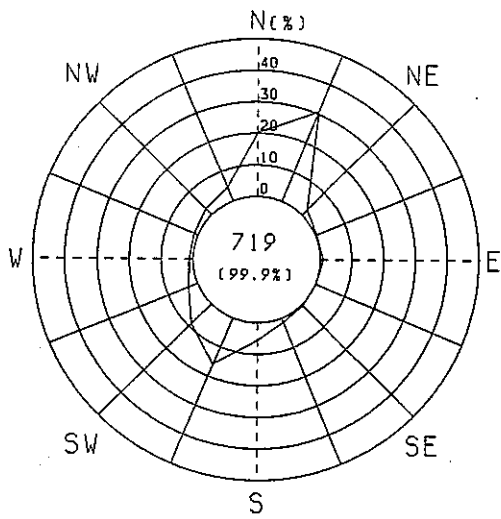

1985/1/2 0:00 - 1985/1/31 23:55

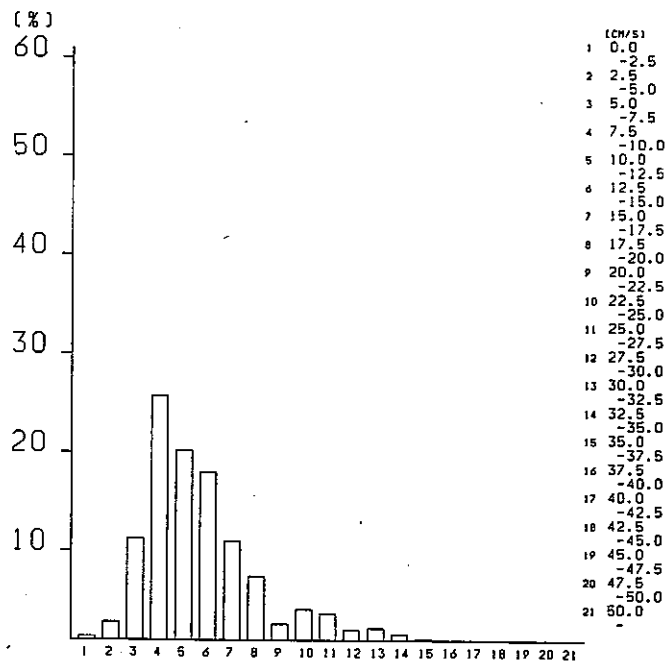
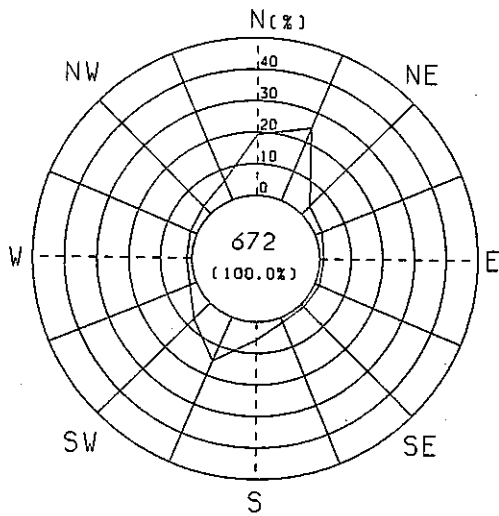

1985/2/1 0:00 - 1985/2/28 23:55

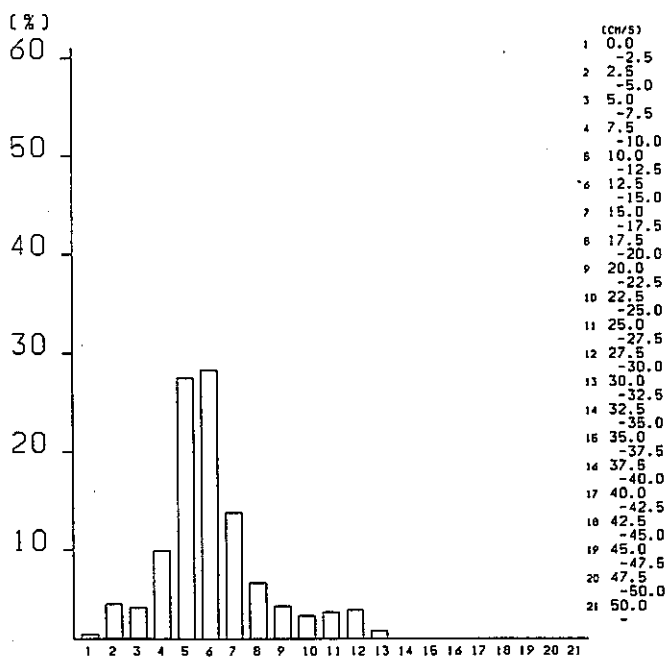
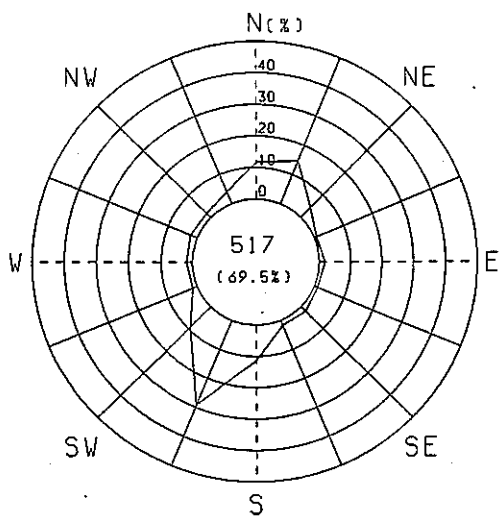

1985/3/1 0:00 - 1985/3/31 23:55

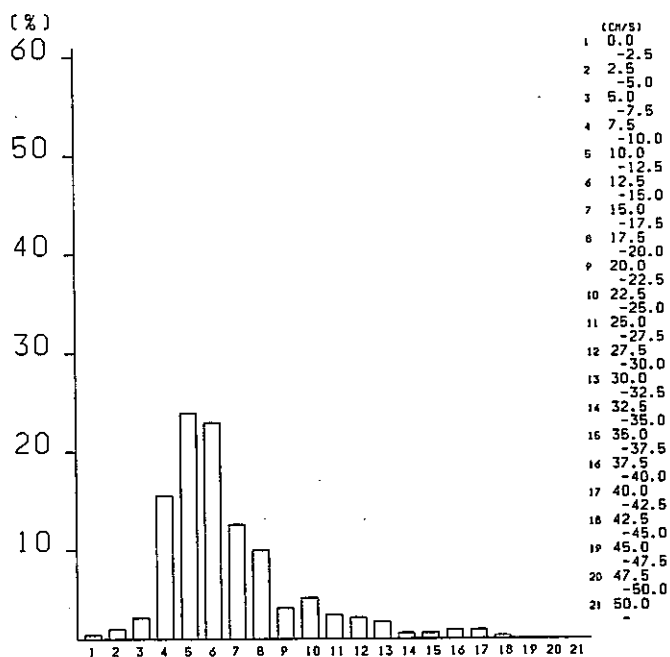
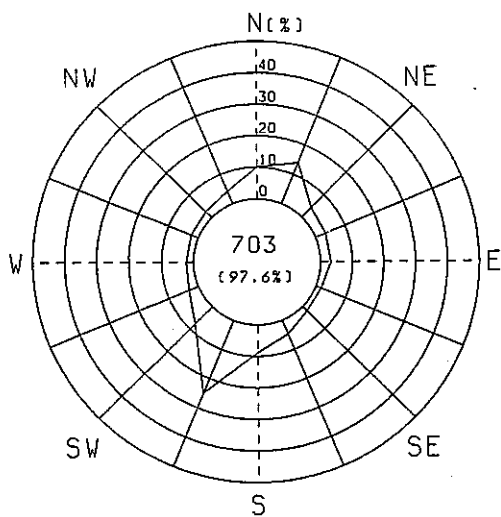

1985/4/1 0:00 - 1985/4/30 23:55

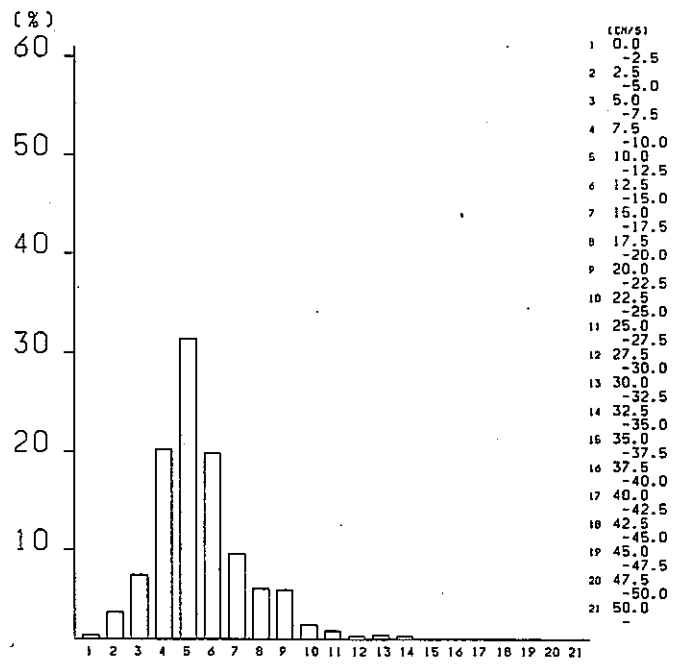
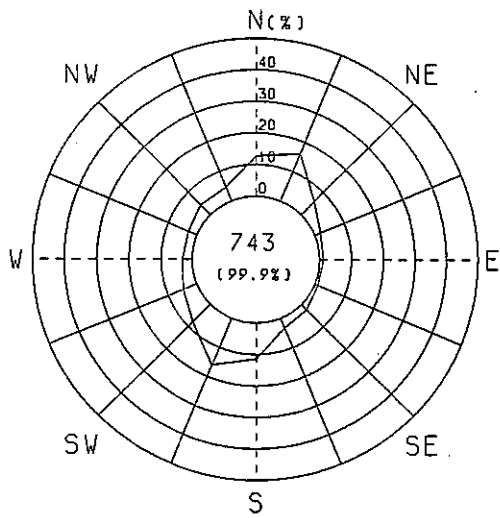

1985/5/1 0:00 - 1985/5/31 23:55

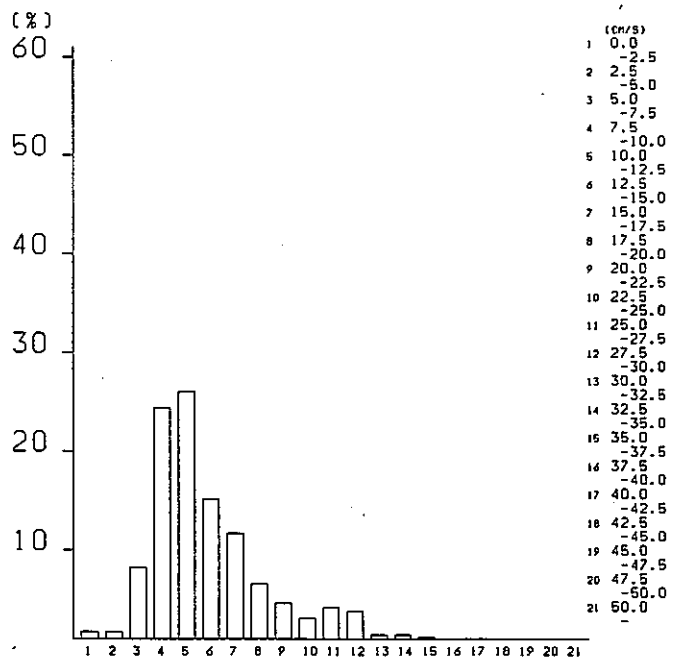
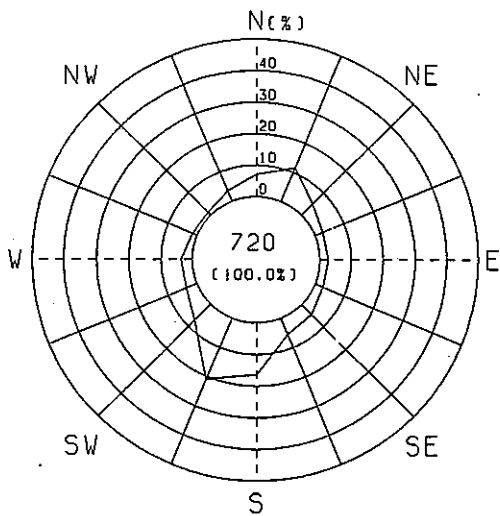

1985/6/1 0:00 - 1985/6/30 23:55

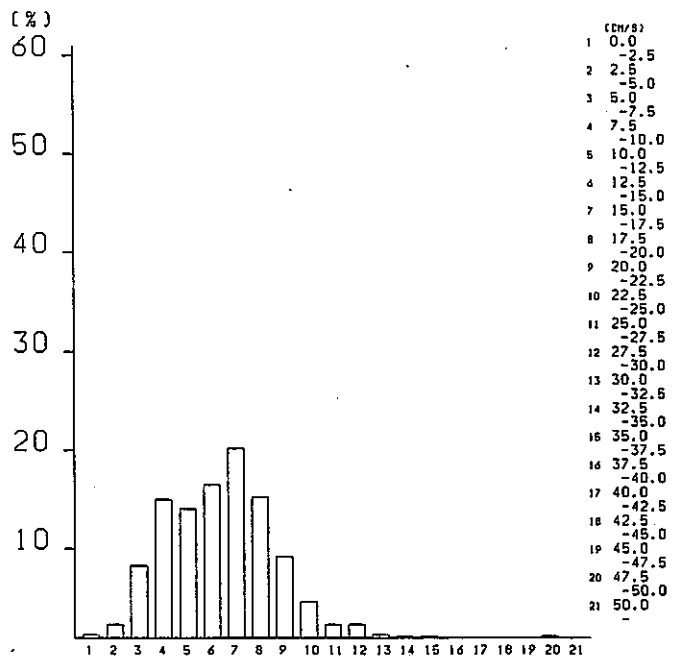
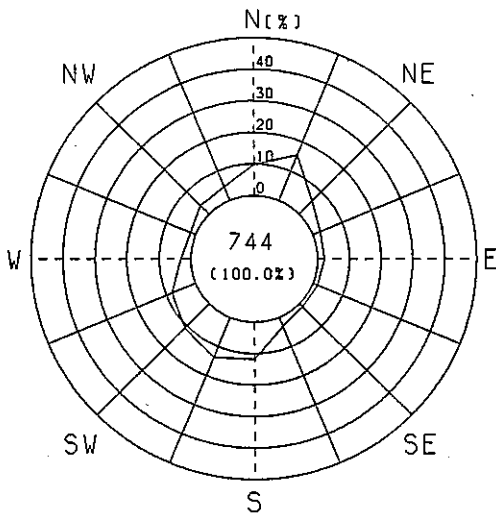

1985/7/1 0:00 - 1985/7/31 23:55

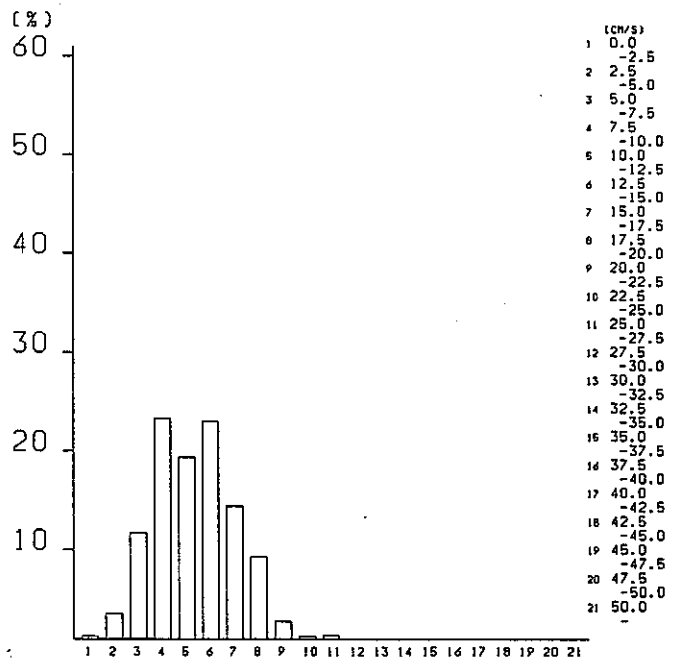
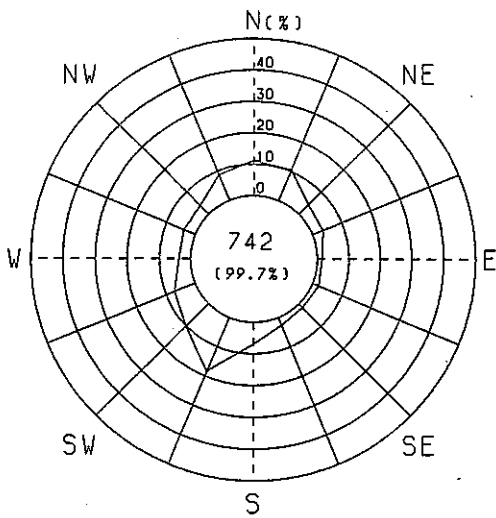

1985/8/1 0:00 - 1985/8/31 23:55

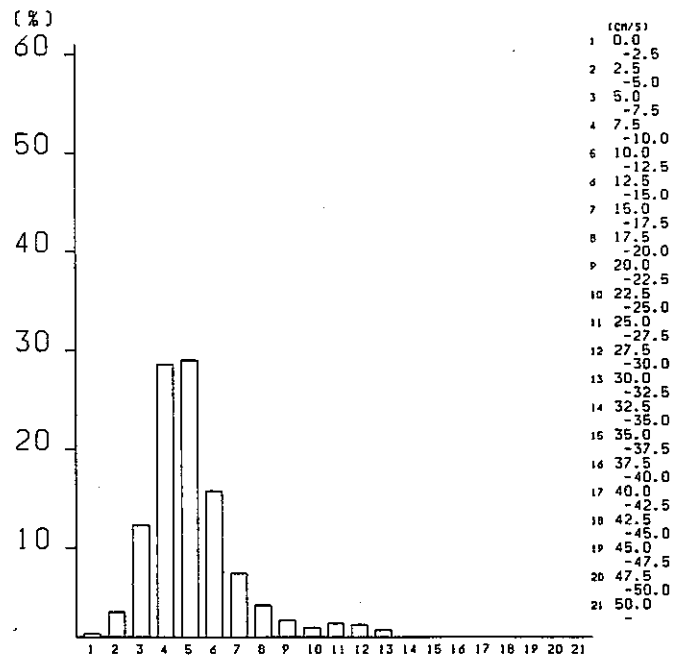
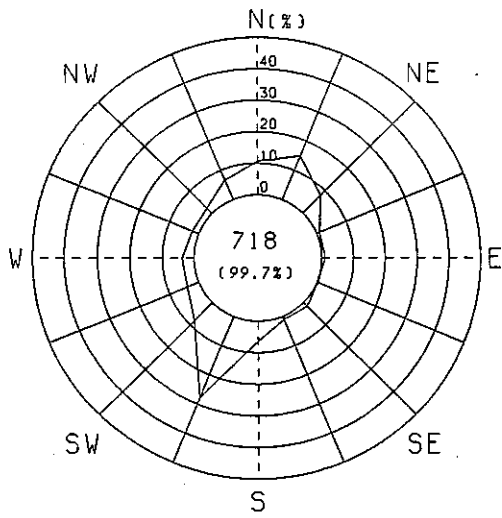

1985/9/1 0:00 - 1985/9/30 23:55

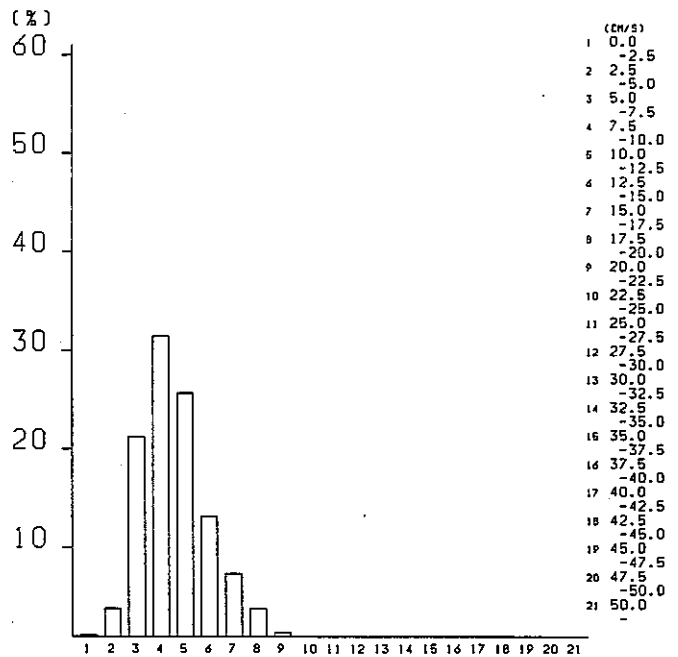
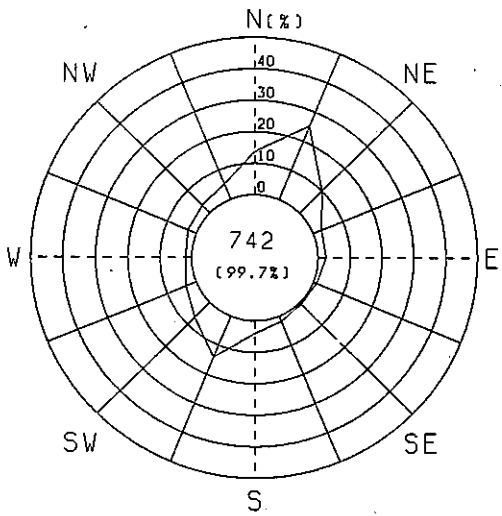

1985/10/1 0:00 - 1985/10/31 23:55

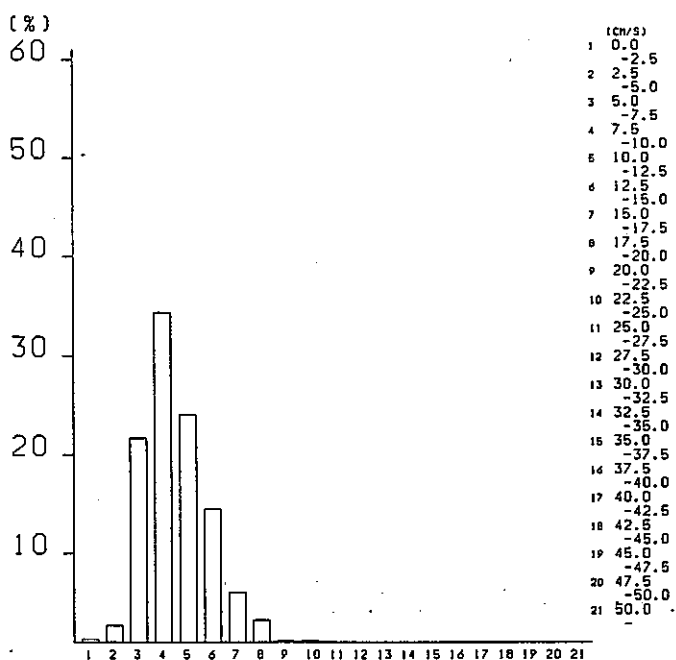
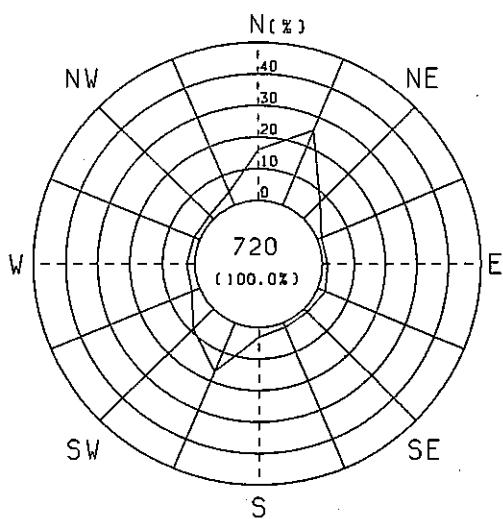

1985/11/1 0:00 - 1985/11/30 23:55

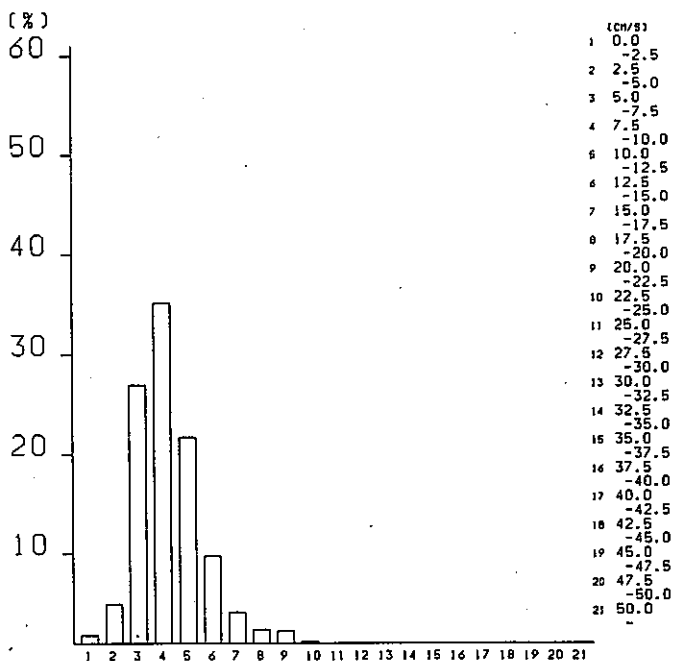
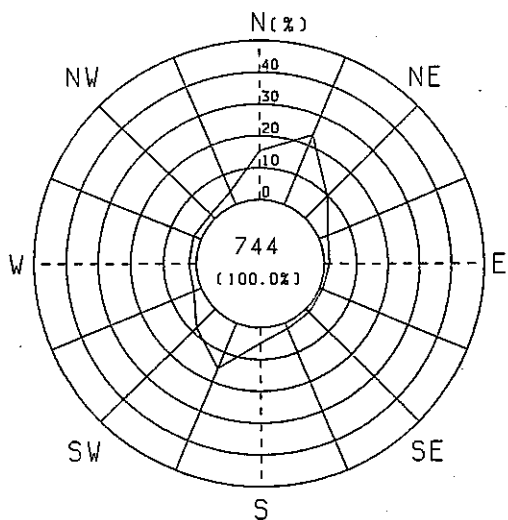

1985/12/1 0:00 - 1985/12/31 23:55

3、海面下16m層における流向頻度及び流速階級頻度の解析結果

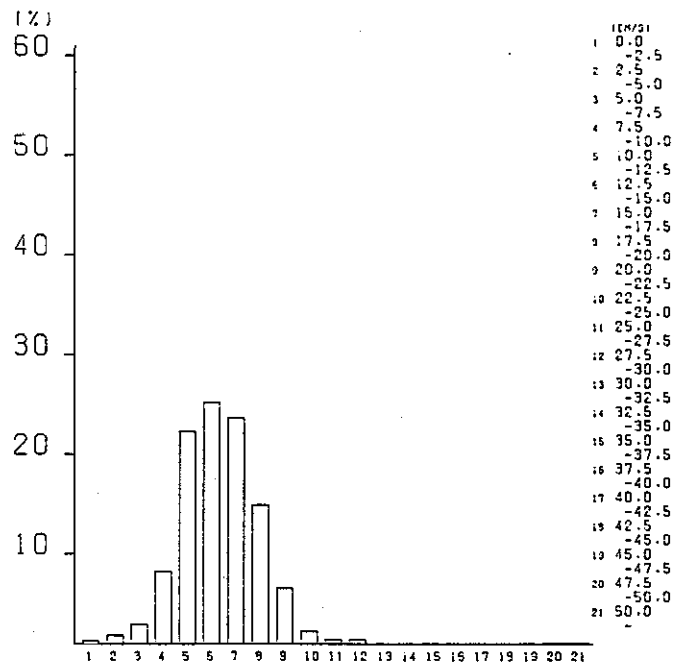
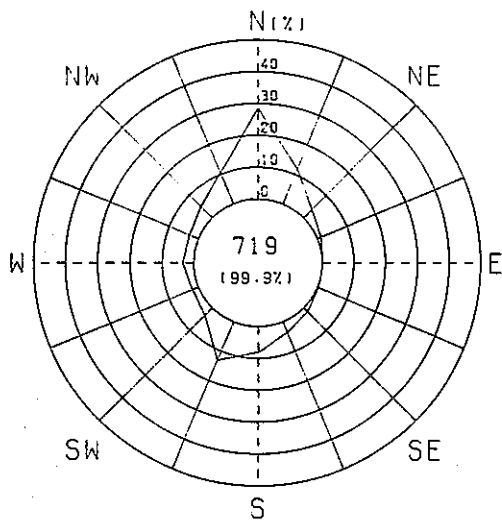

1983/1/2 0:00 - 1983/1/31 23:55

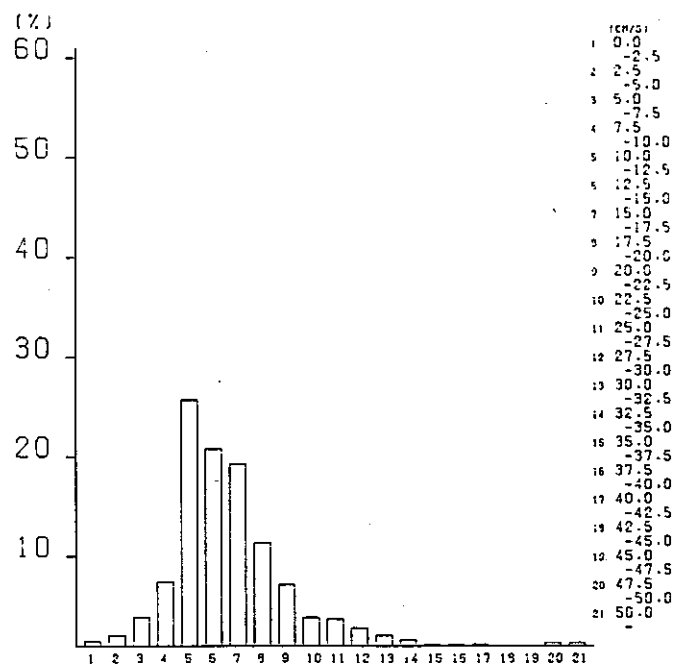
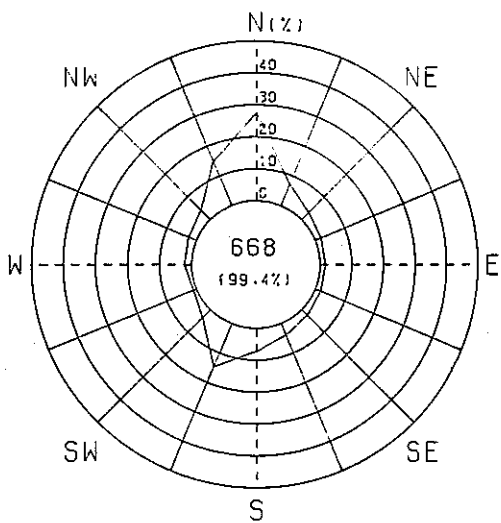

1983/2/1 0:00 - 1983/2/28 23:55

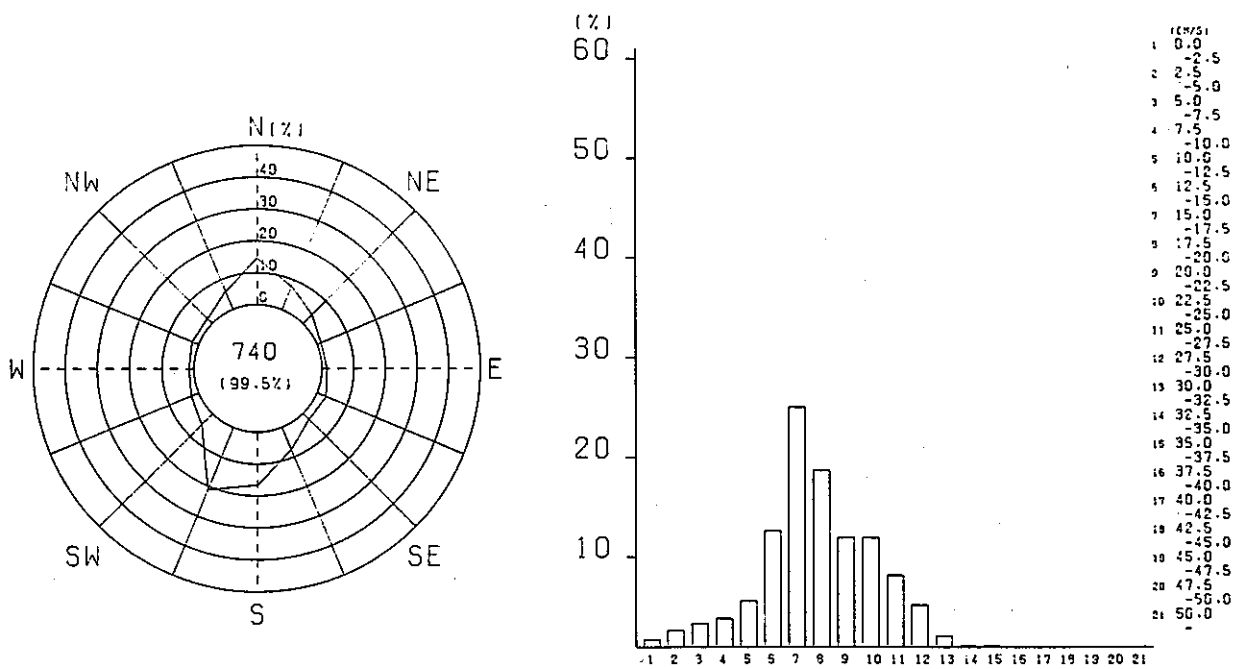

1983/3/1 0:00 - 1983/3/31 23:55

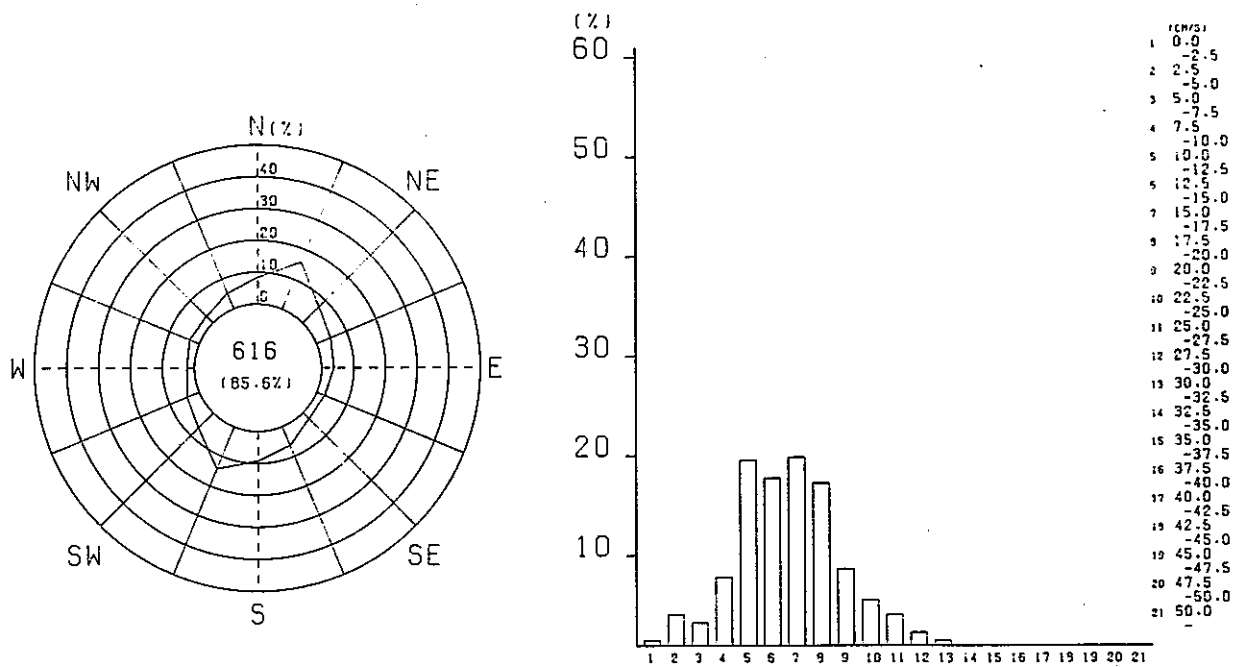

1983/4/1 0:00 - 1983/4/30 23:55

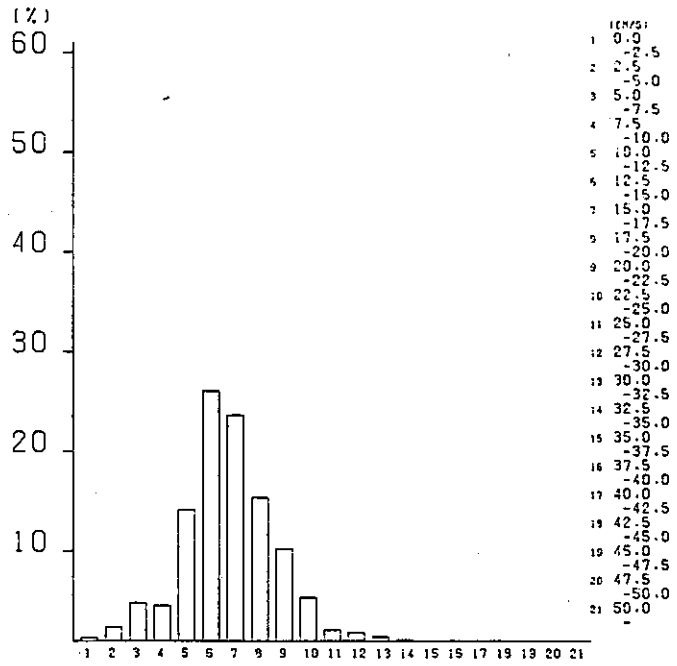
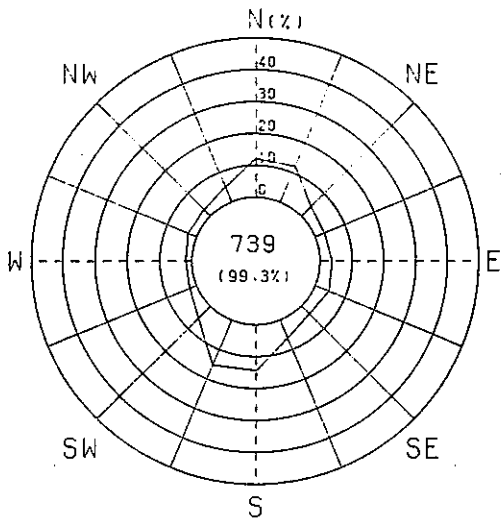

1983/5/1 0:00 - 1983/5/31 23:55

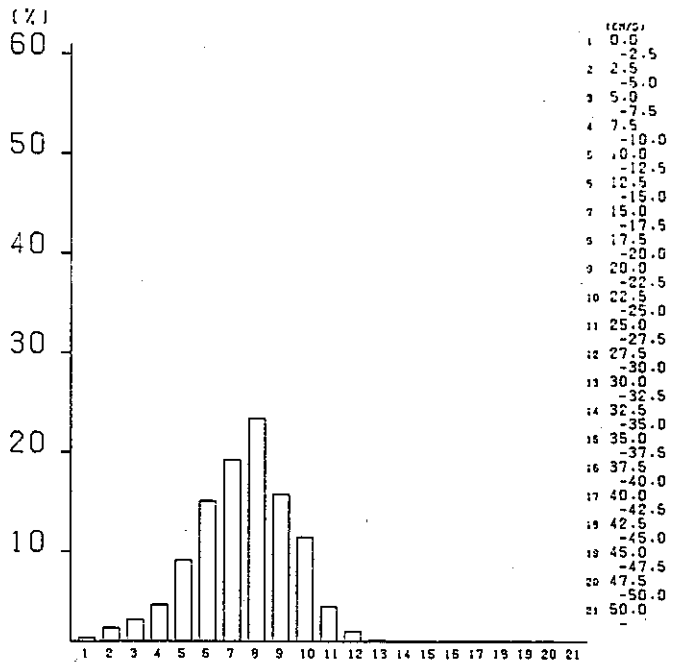
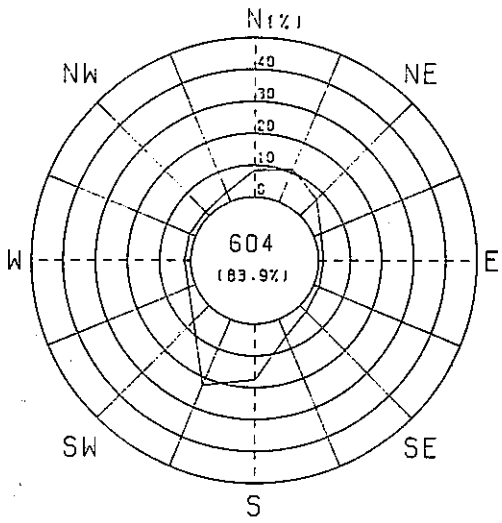

1983/6/1 0:00 - 1983/6/30 23:55

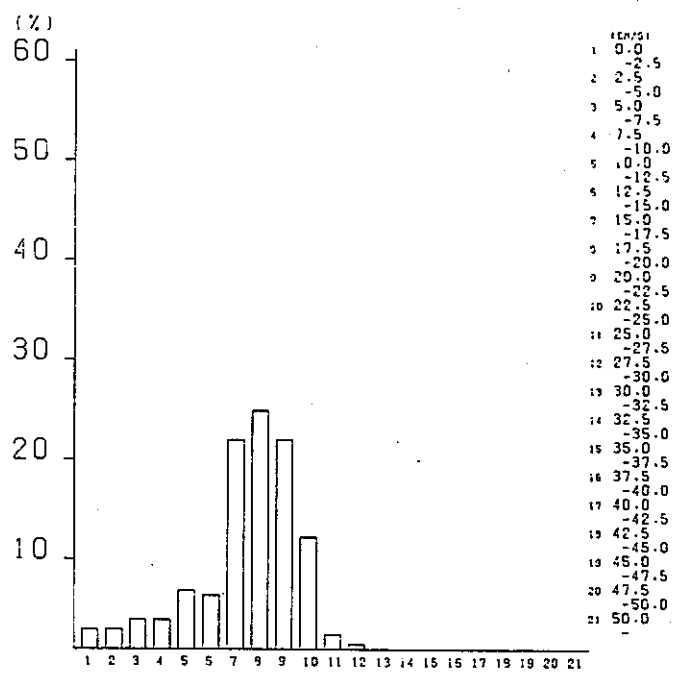
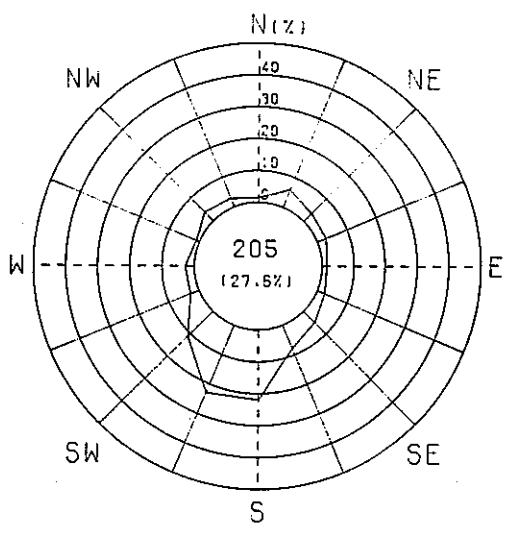

1983/7/1 0:00 - 1983/7/31 23:55

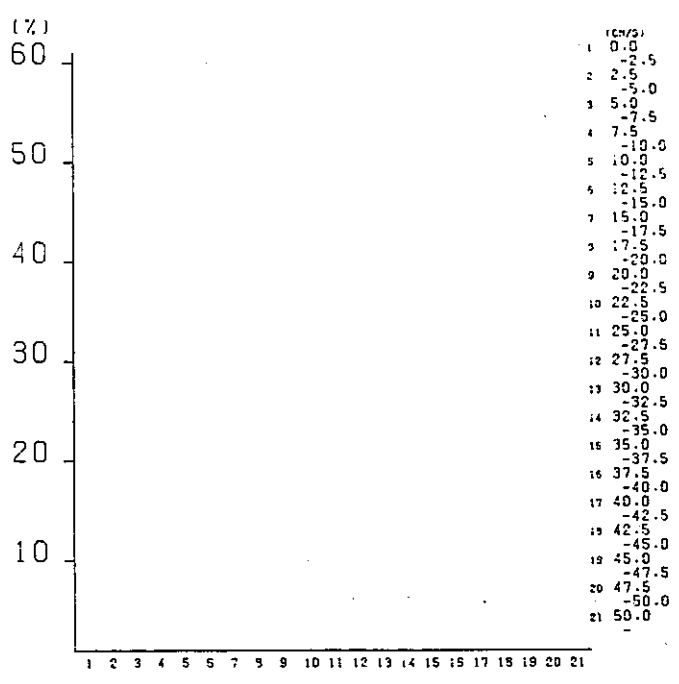
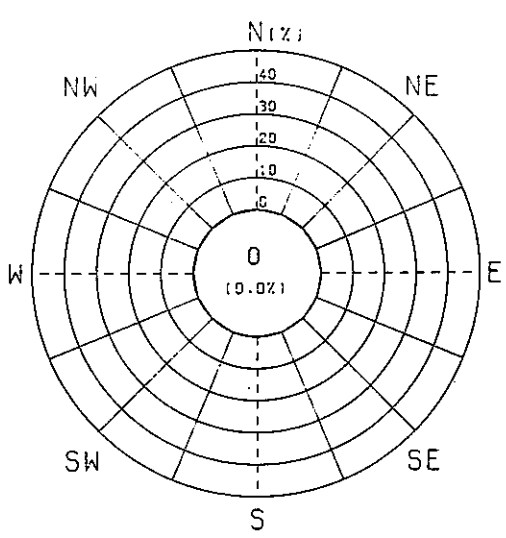

1983/8/1 0:00 - 1983/8/31 23:55

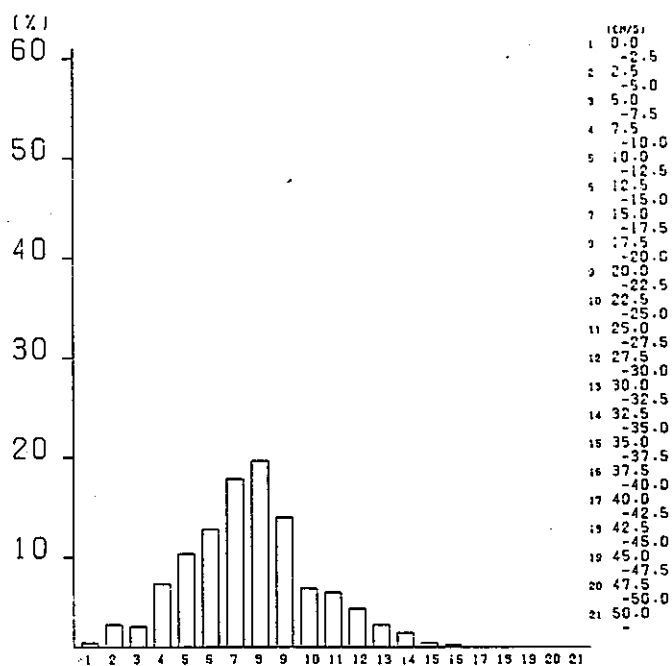
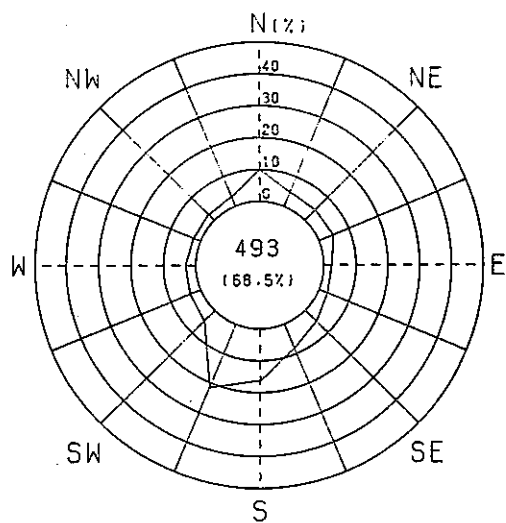

1983/9/1 0:00 - 1983/9/30 23:55

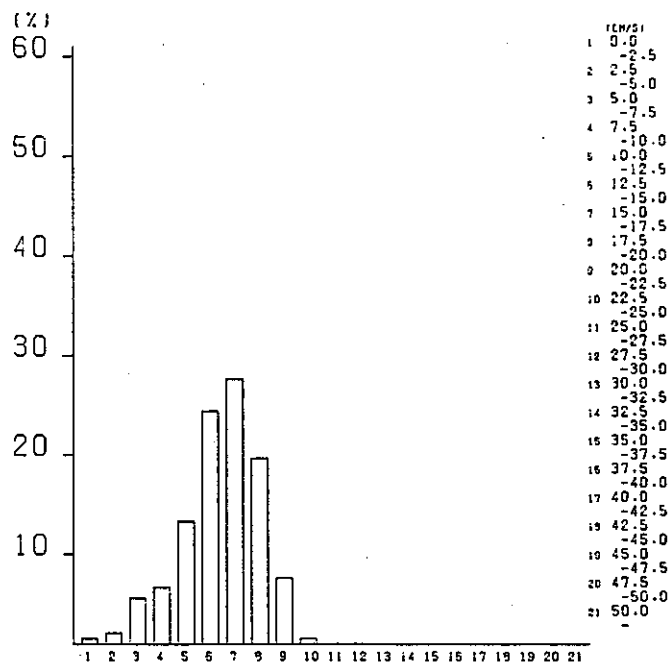
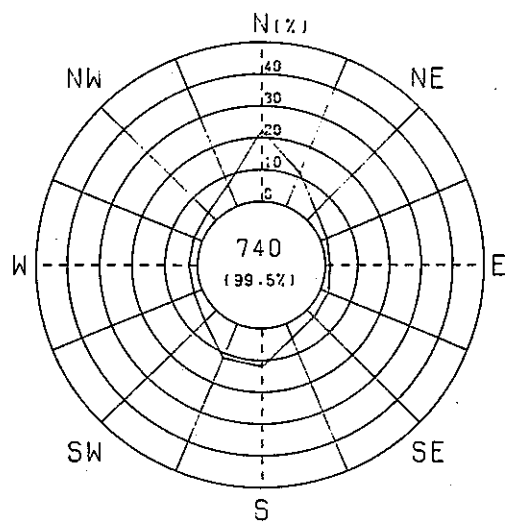

1983/10/1 0:00 - 1983/10/31 23:55

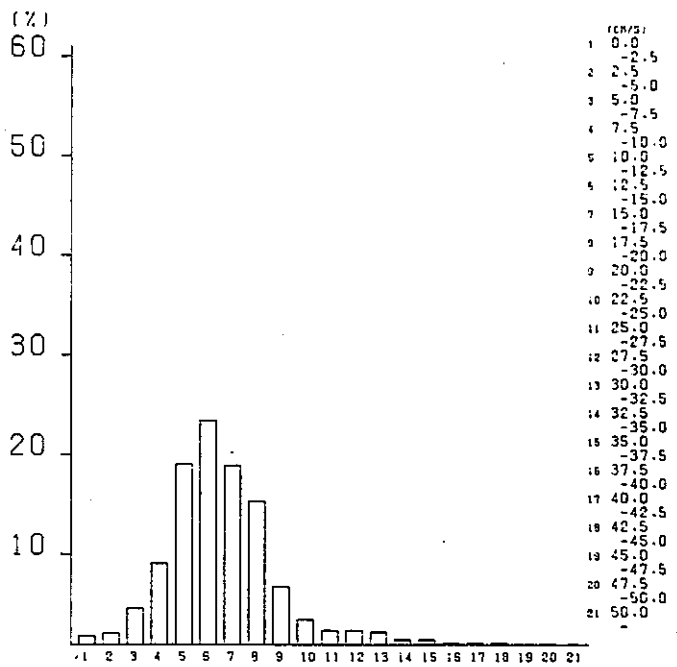
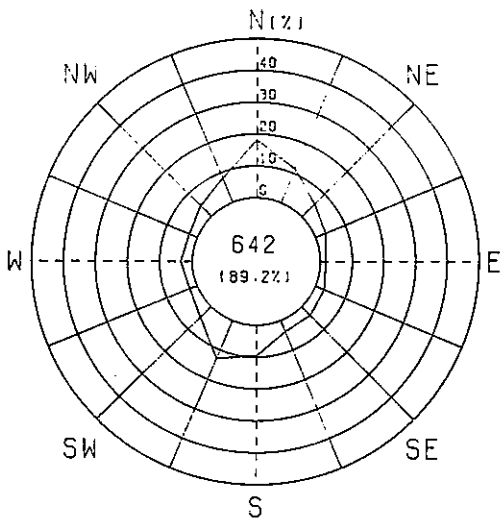

1983/11/1 0:00 - 1983/11/30 23:55

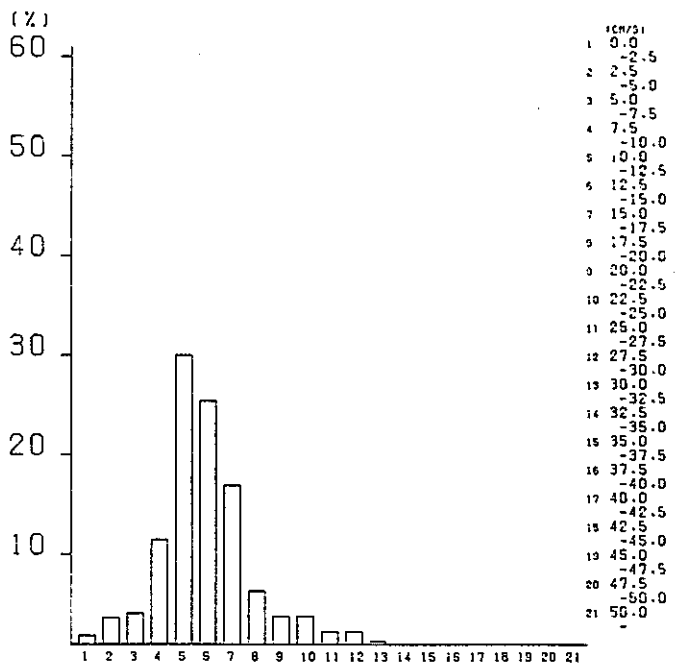
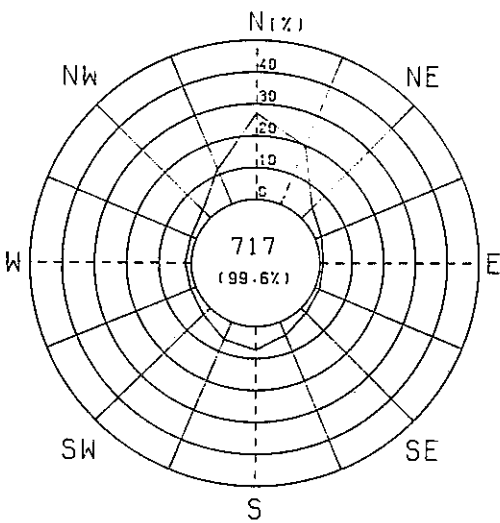

1983/12/1 0:00 - 1983/12/31 23:55

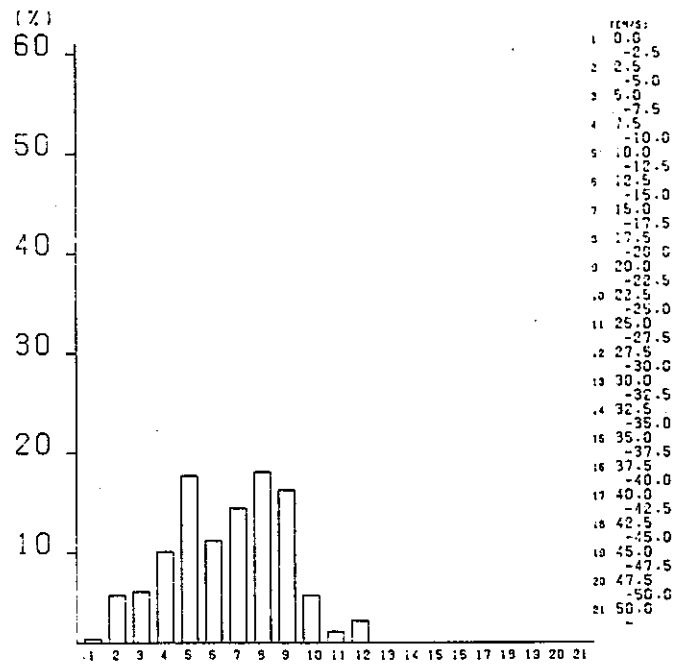
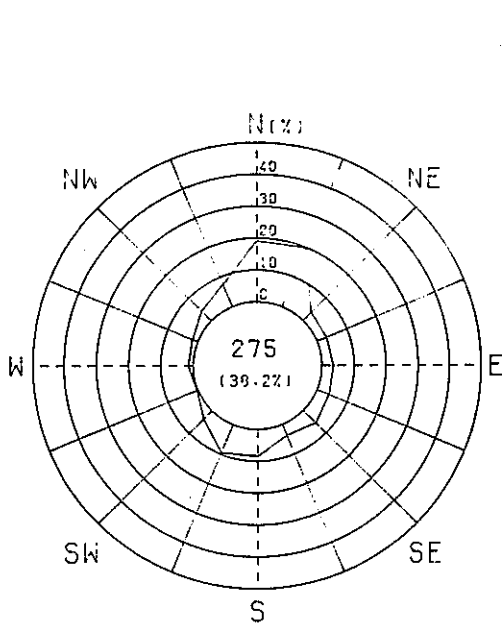

1984/1/2 0:00 - 1984/1/31 23:55

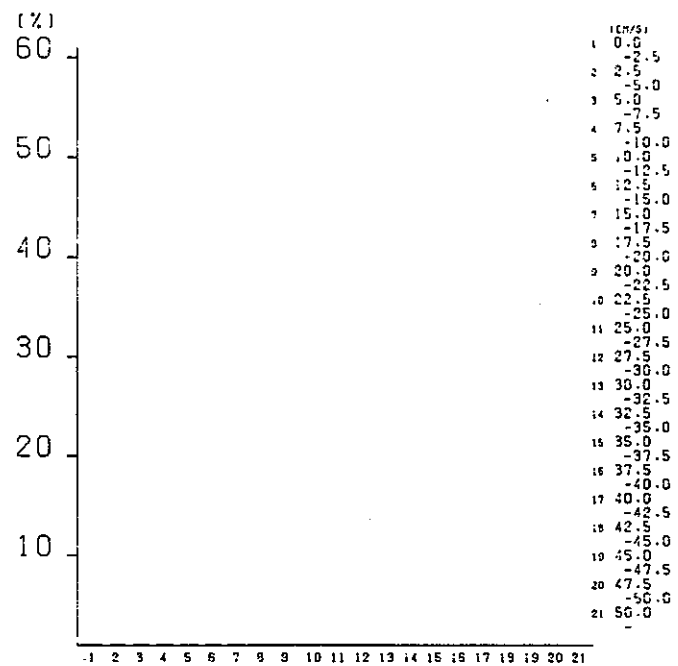
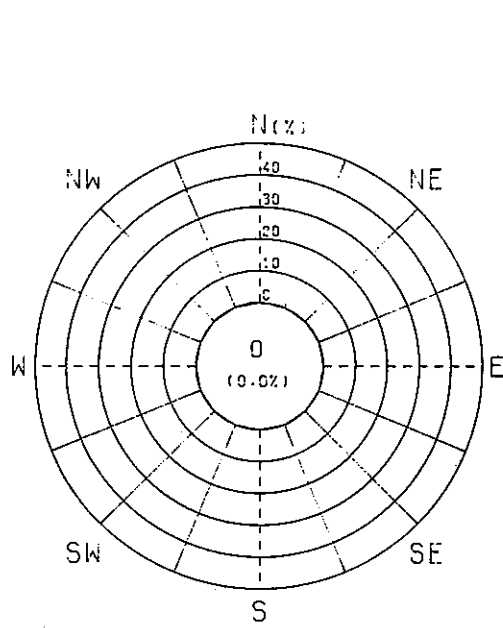

1984/2/1 0:00 - 1984/2/28 23:55

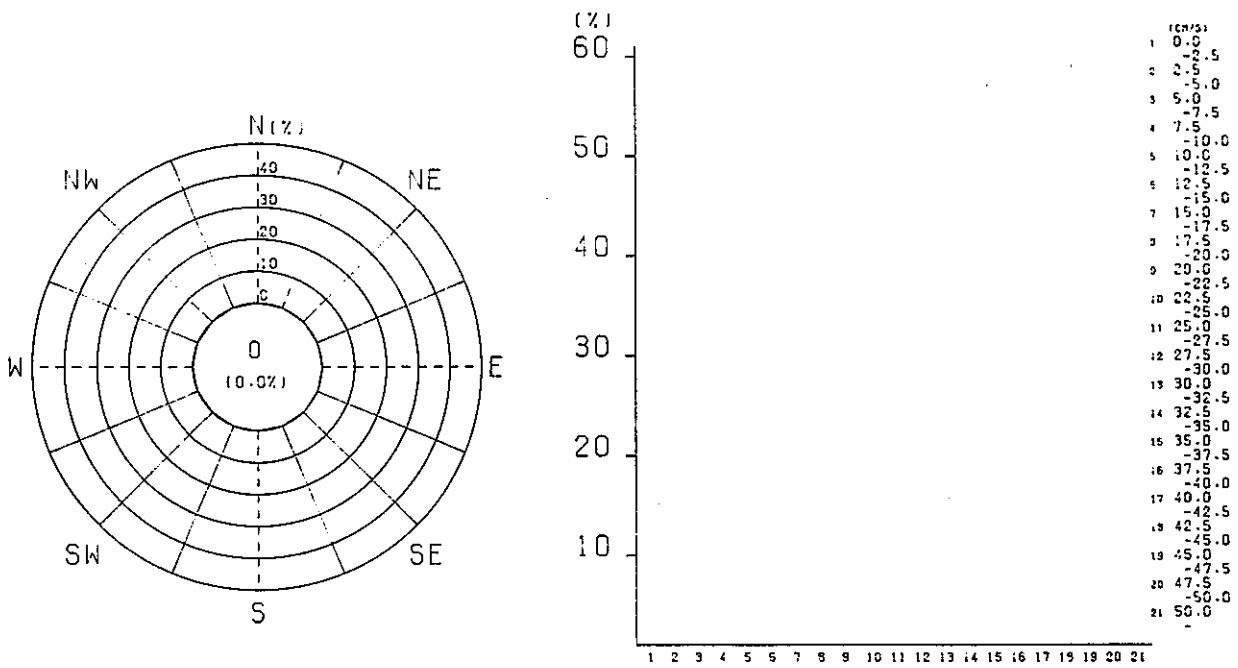

1984/3/1 0:00 - 1984/3/31 23:55

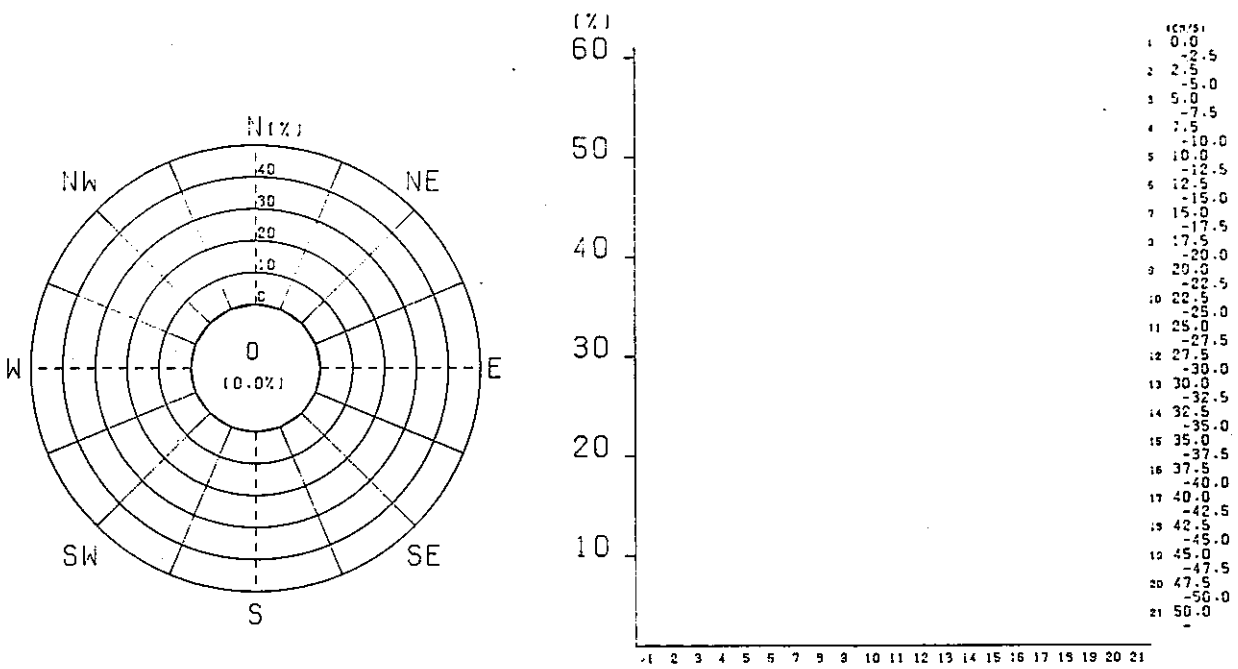

1984/4/1 0:00 - 1984/4/30 23:55

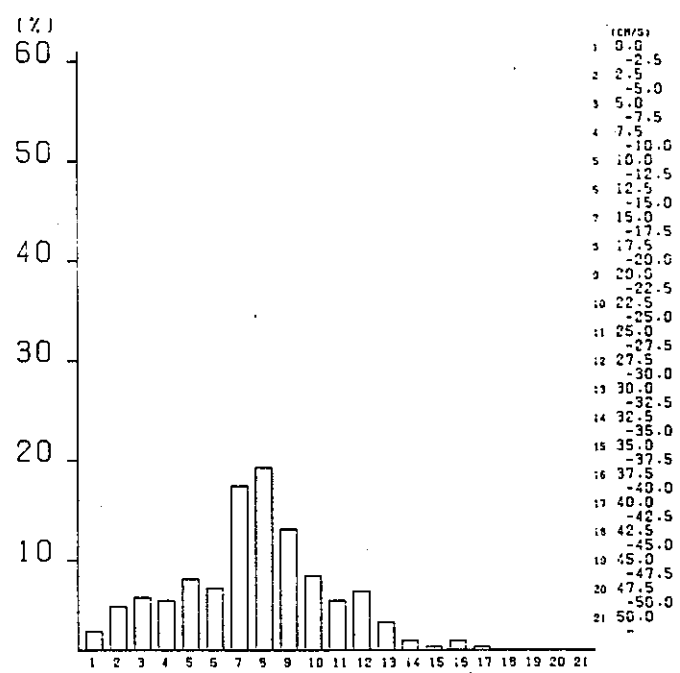
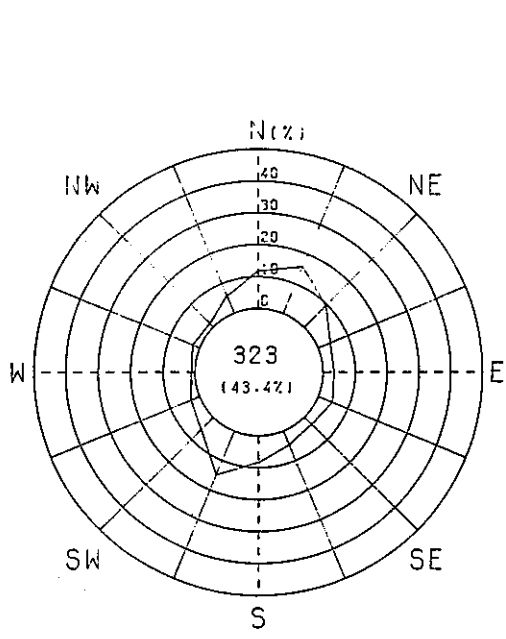

1984/5/1 0:00 - 1984/5/31 23:55

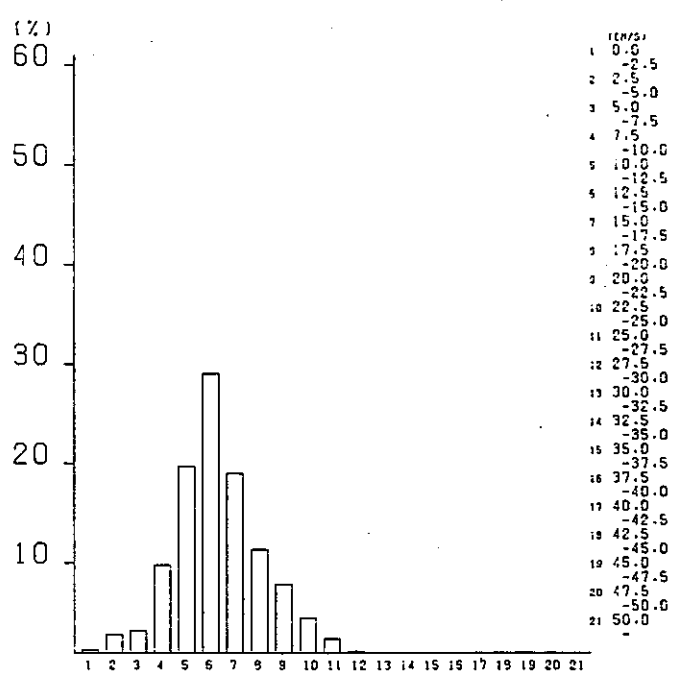
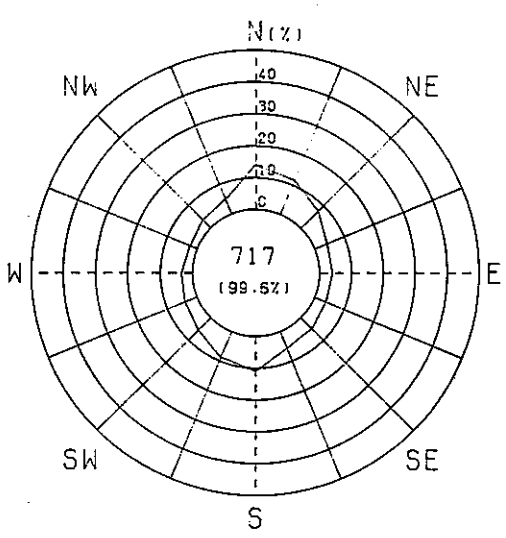

1984/6/1 0:00 - 1984/6/30 23:55

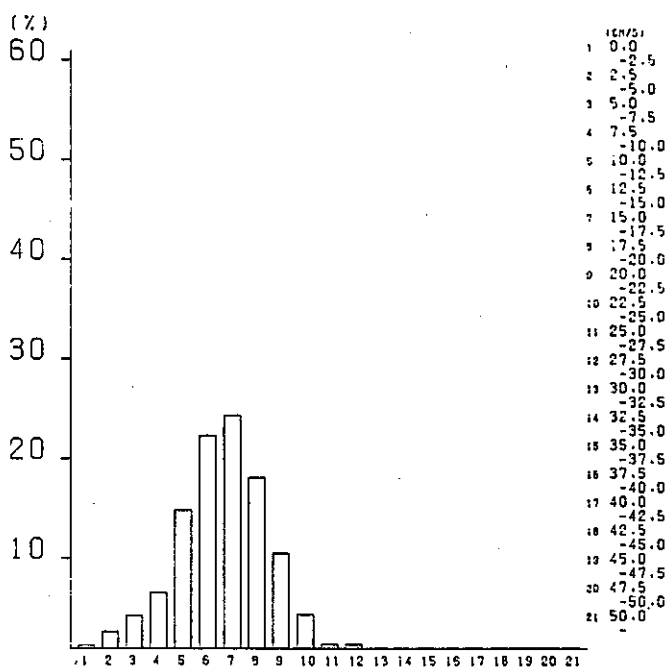
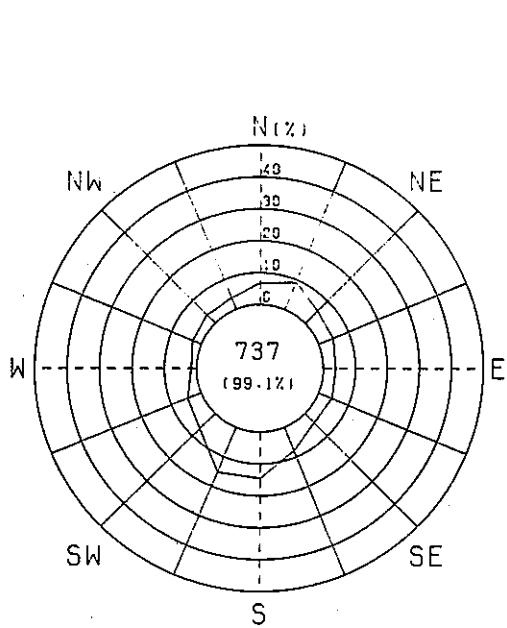

1984/7/1 0:00 - 1984/7/31 23:55

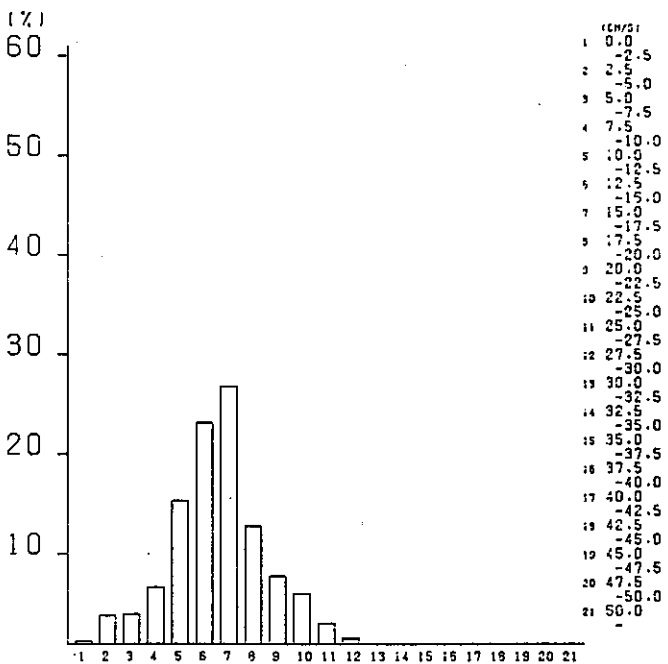
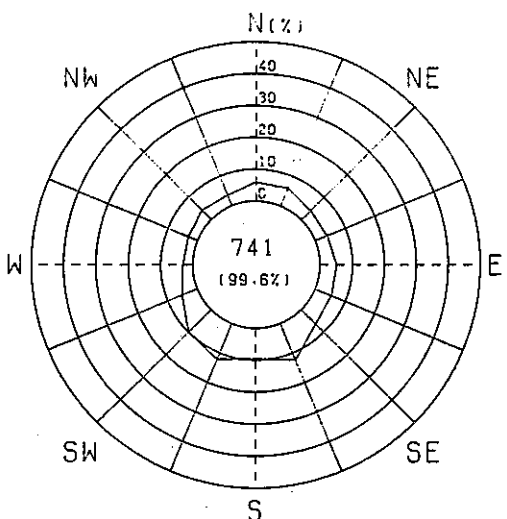

1984/8/1 0:00 - 1984/8/31 23:55

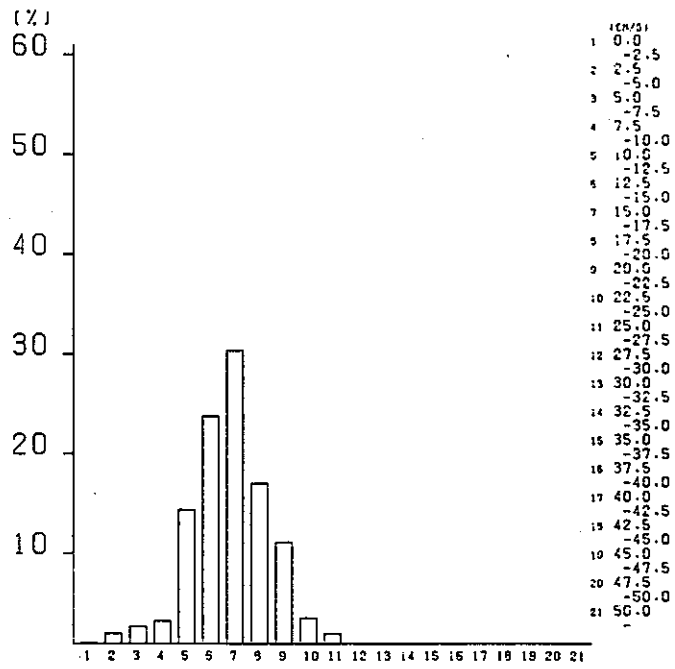
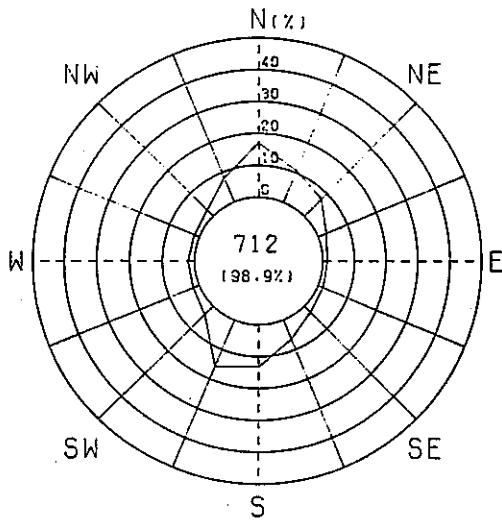

1984/9/1 0:00 - 1984/9/30 23:55

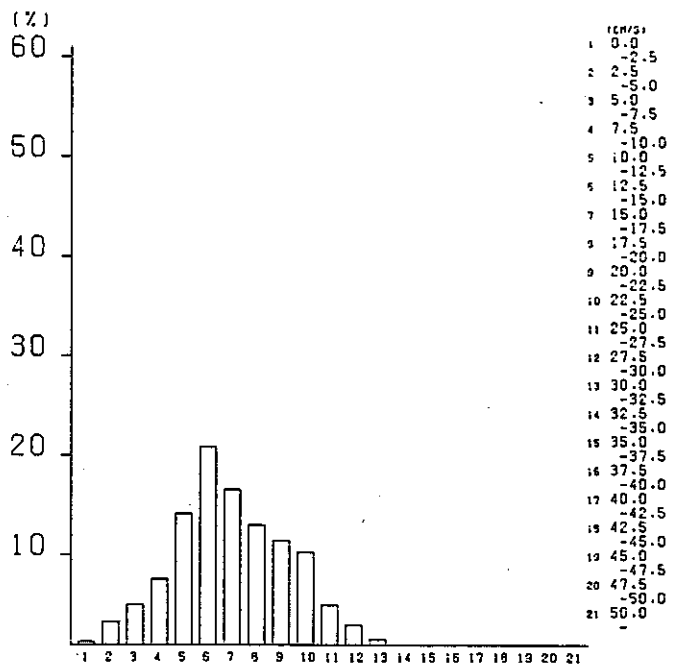
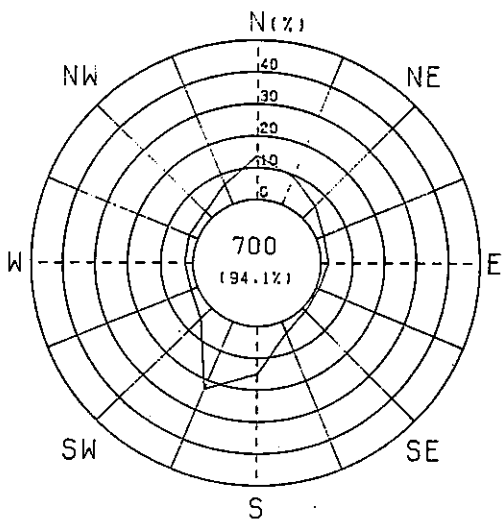

1984/10/1 0:00 - 1984/10/31 23:55

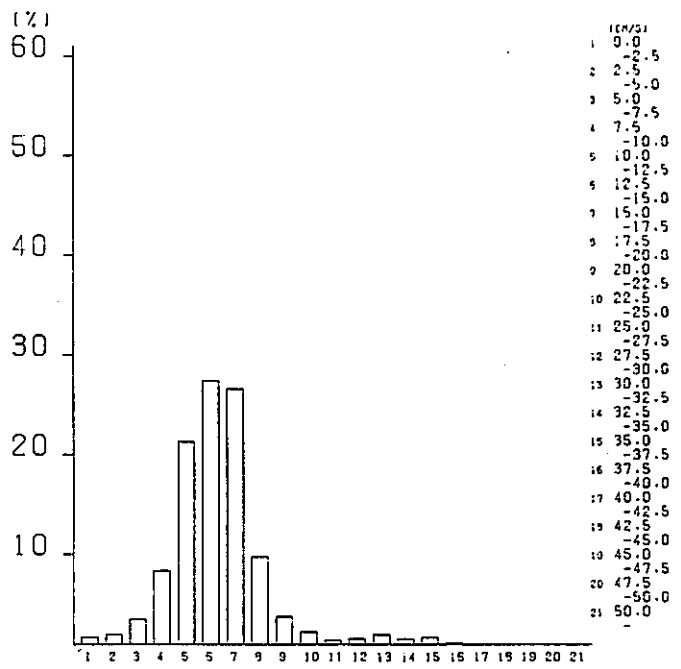
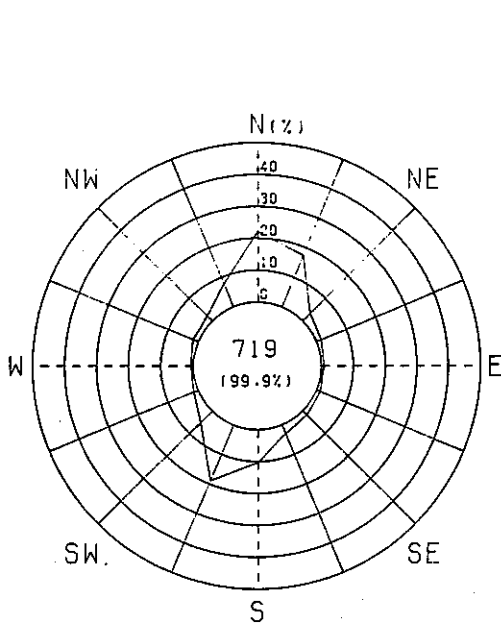

1984/11/1 0:00 - 1984/11/30 23:55

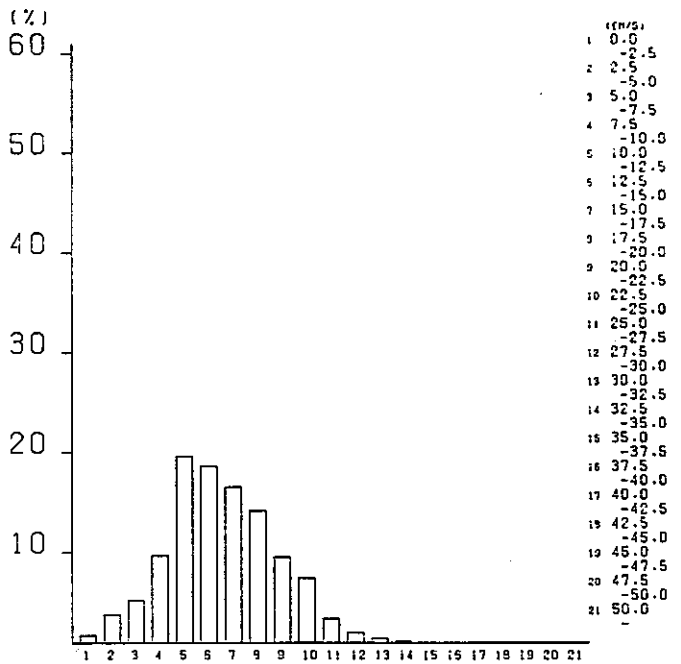
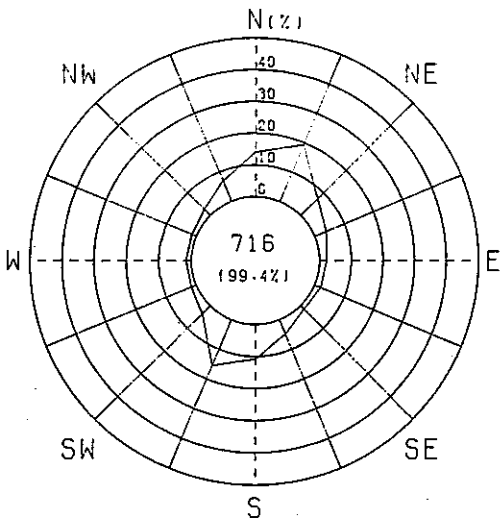

1984/12/1 0:00 - 1984/12/31 23:55

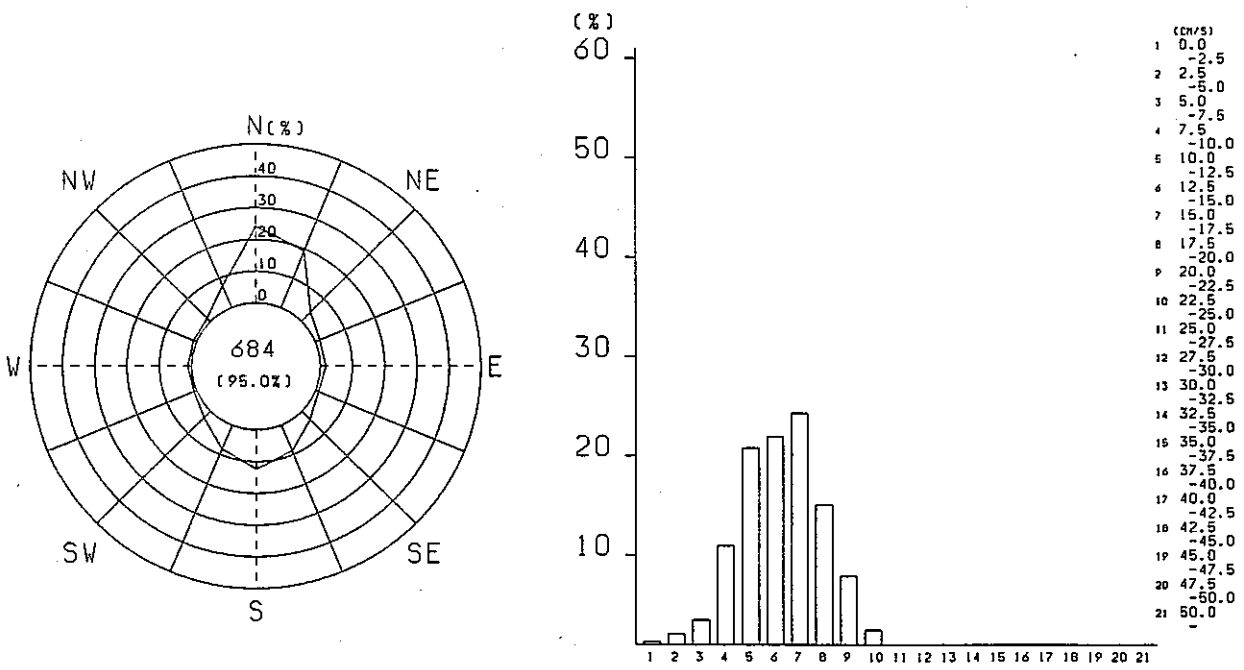

1985/1/2 0:00 - 1985/1/31 23:55

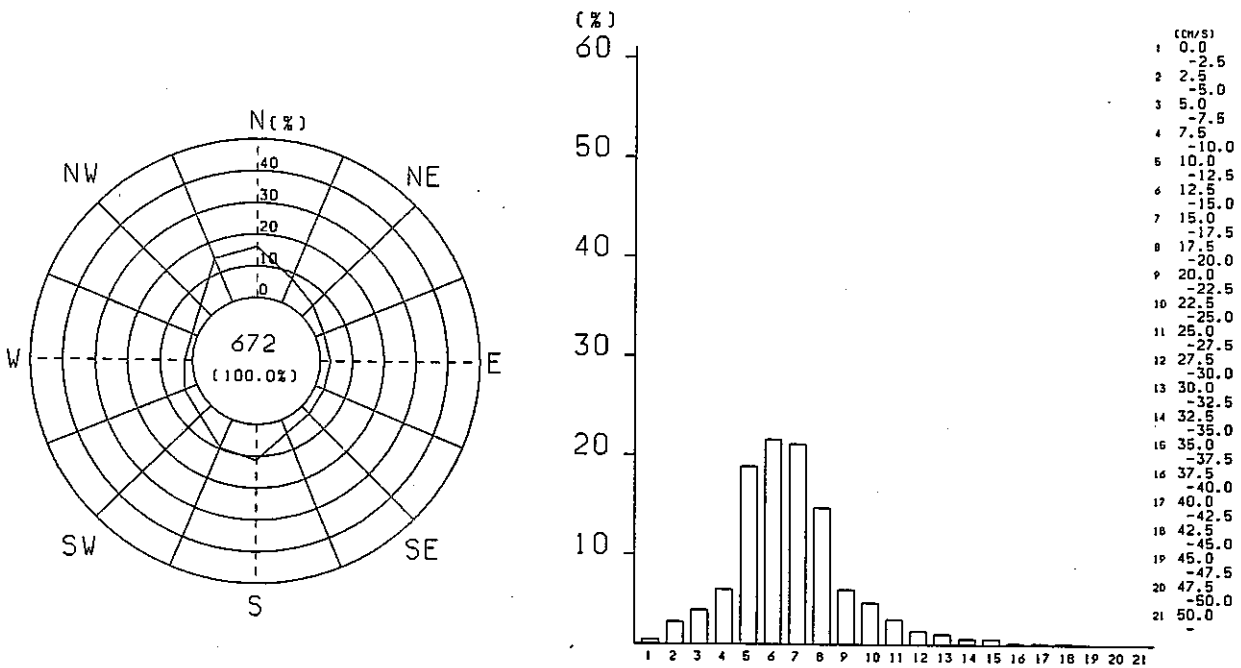

1985/2/1 0:00 - 1985/2/28 23:55

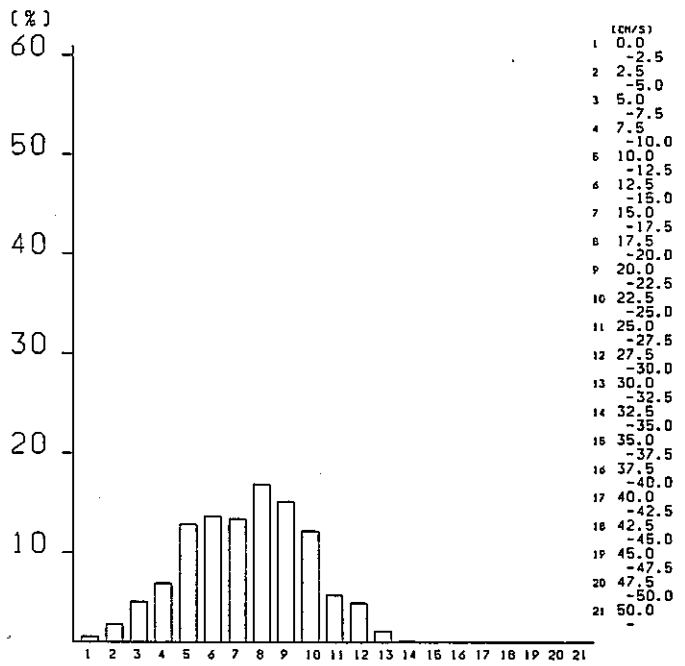
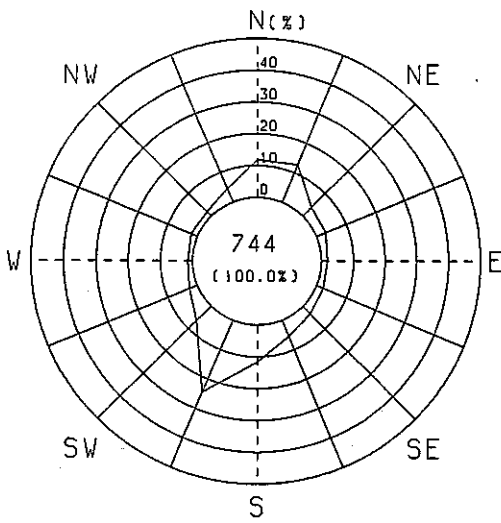

1985/3/1 0:00 - 1985/3/31 23:55

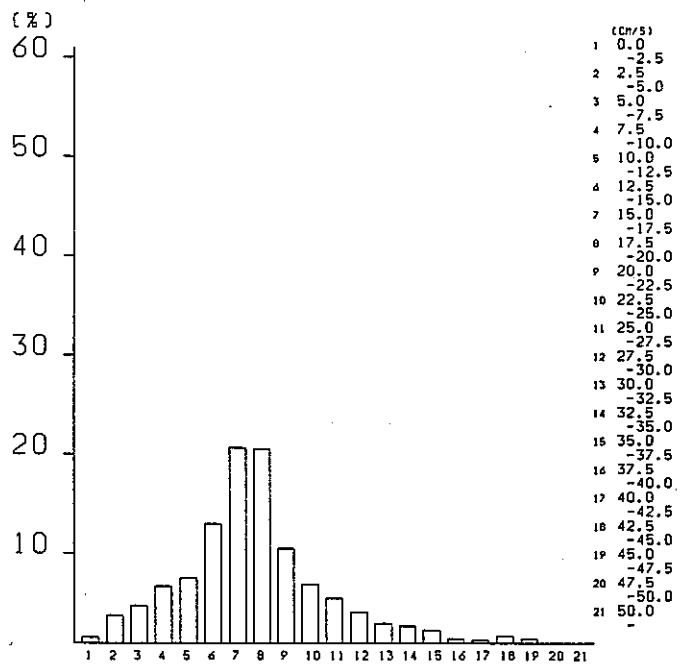
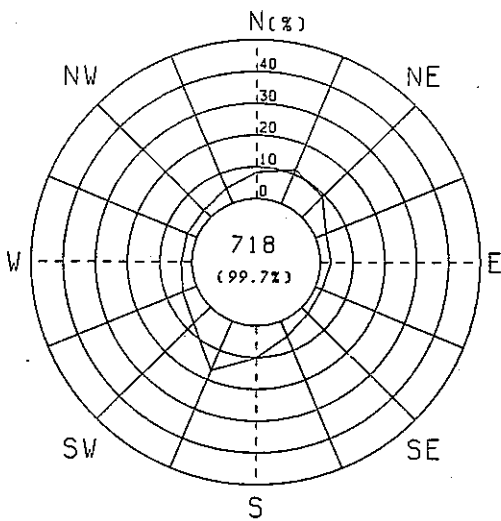

1985/4/1 0:00 - 1985/4/30 23:55

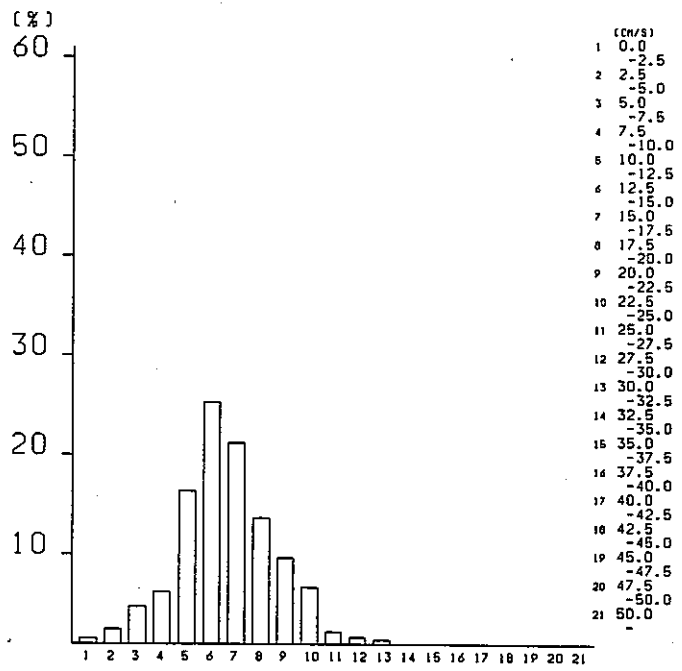
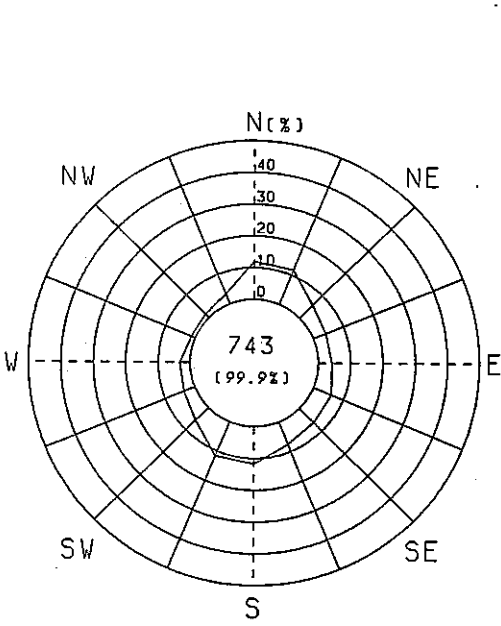

1985/5/1 0:00 - 1985/5/31 23:55

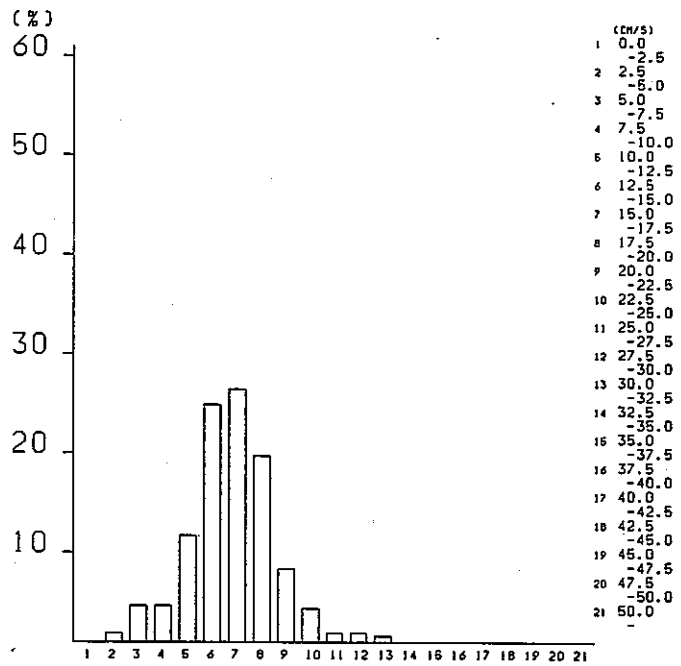
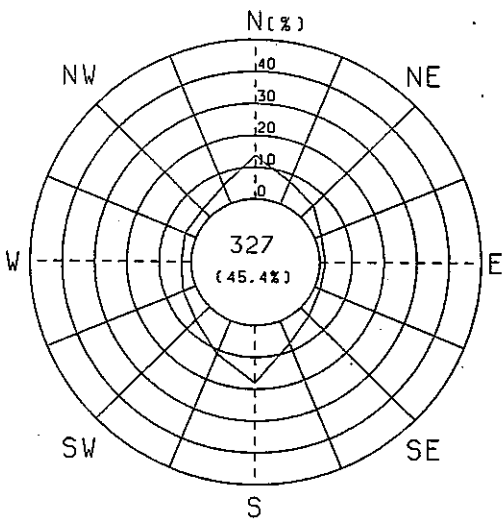

1985/6/1 0:00 - 1985/6/30 23:55

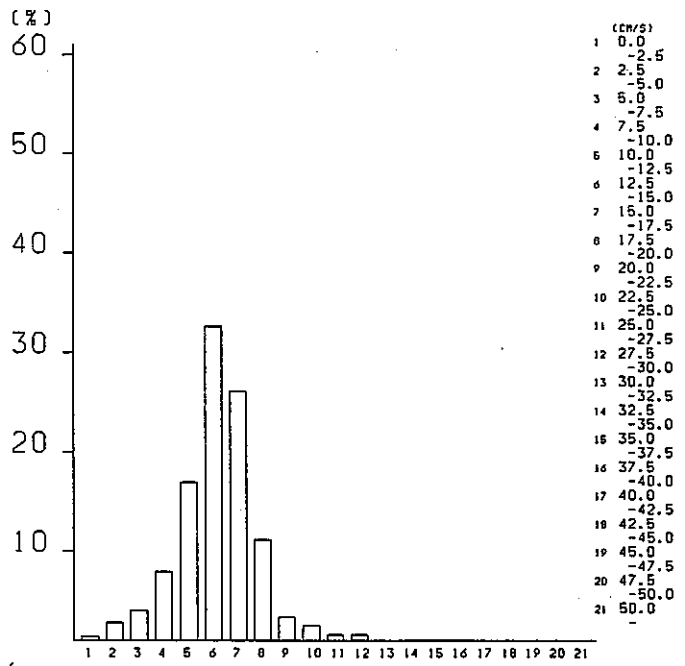
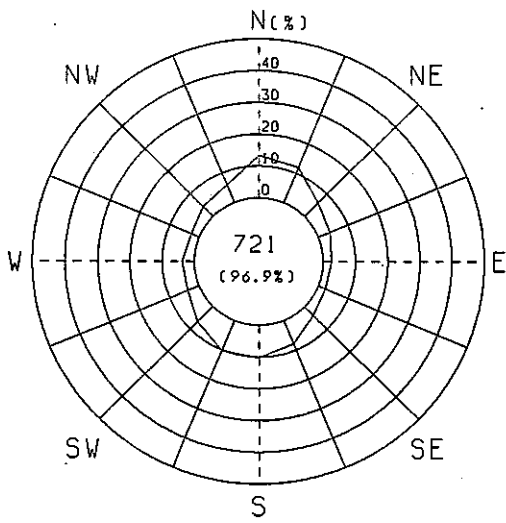

1985/7/1 0:00 - 1985/7/31 23:55

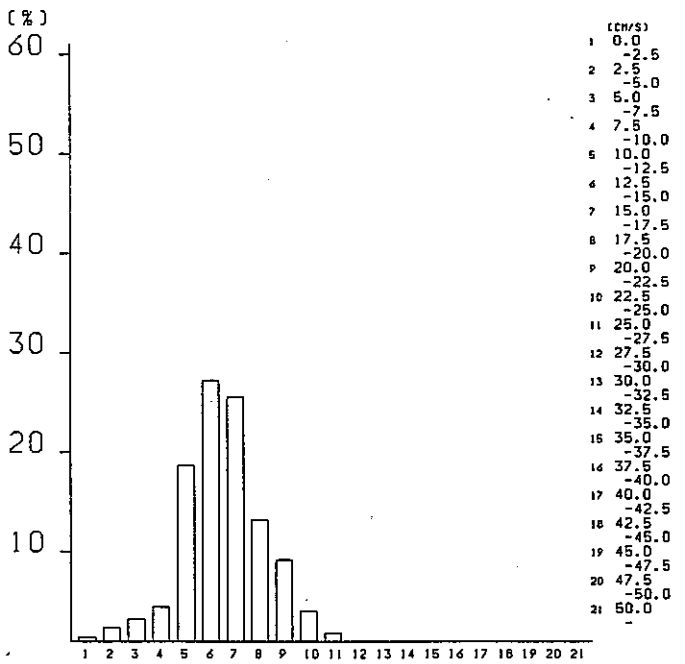
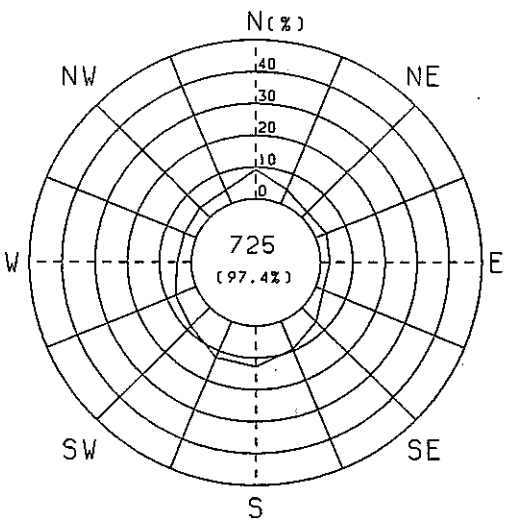

1985/8/1 0:00 - 1985/8/31 23:55

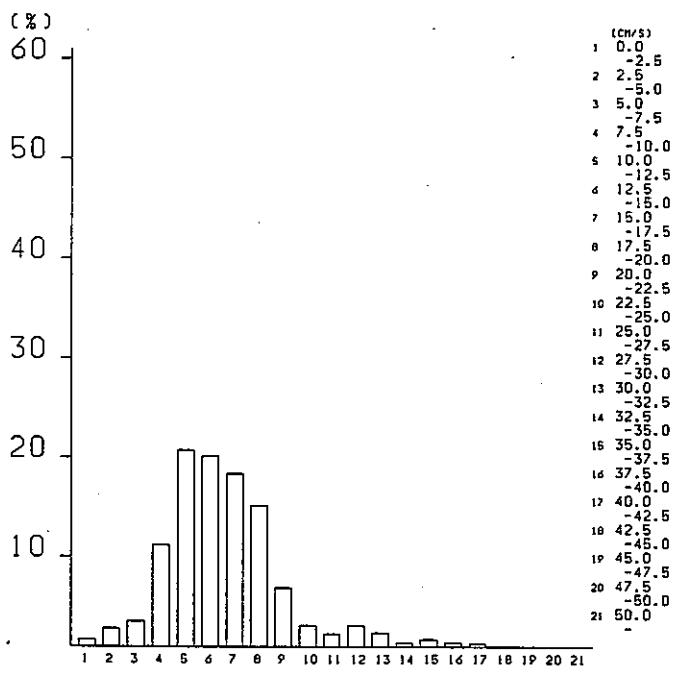
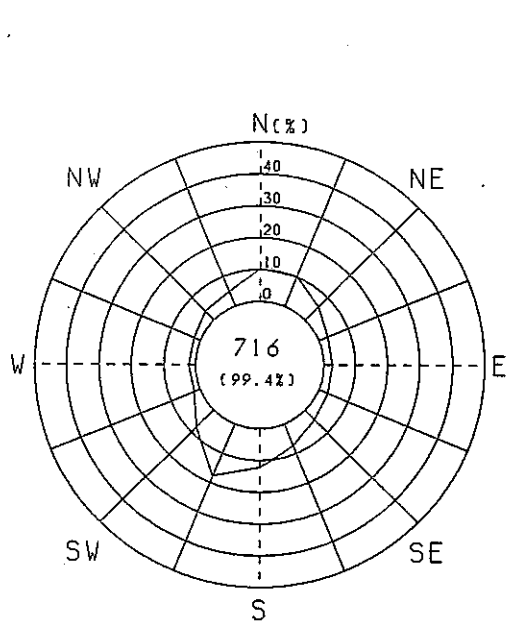

1985/9/1 0:00 - 1985/9/30 23:55

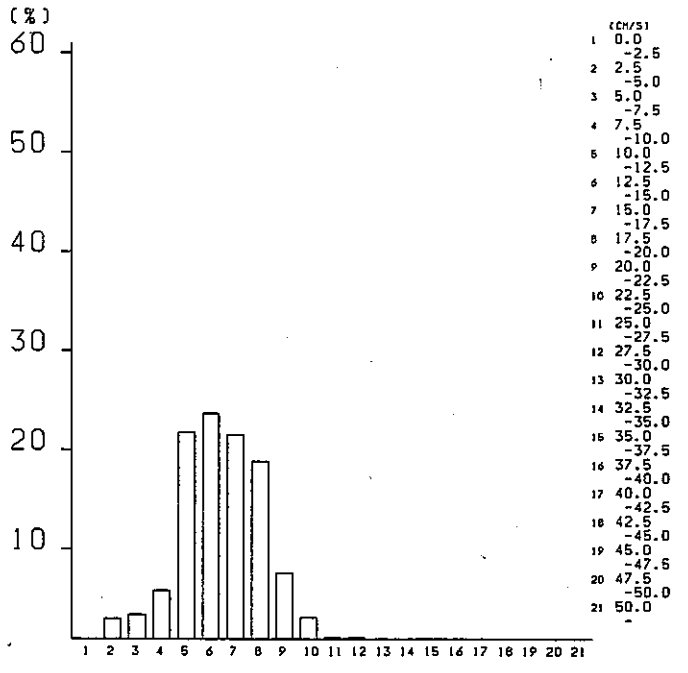
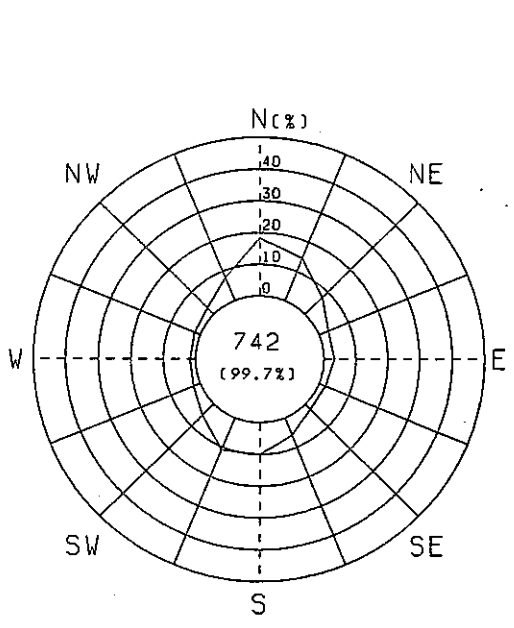

1985/10/1 0:00 - 1985/10/31 23:55

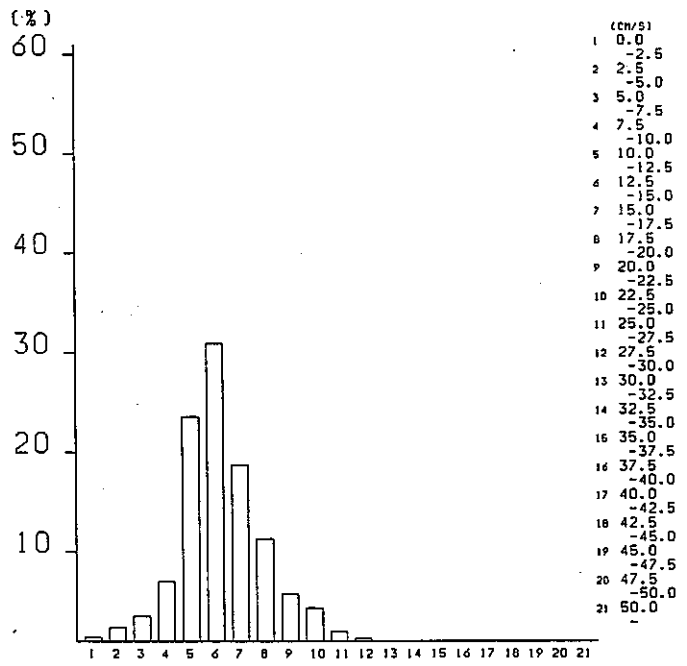
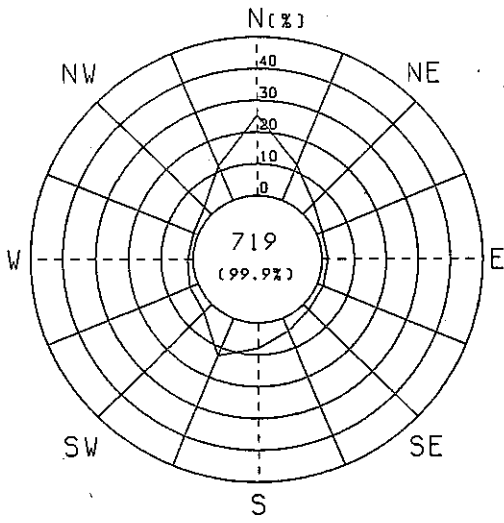

1985/11/1 0:00 - 1985/11/30 23:55

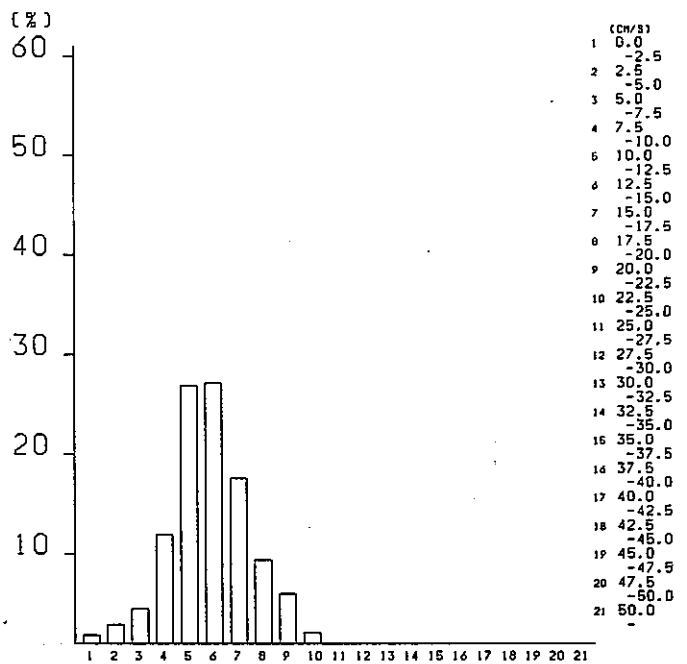
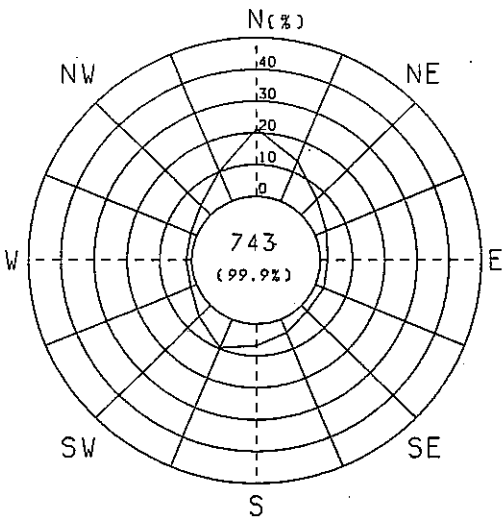

1985/12/1 0:00 - 1985/12/31 23:55